

m o o o i

Boutique Sofa

MARCEL WANDERS

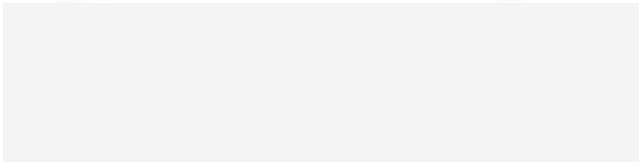
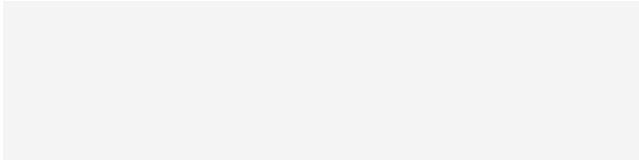

Conceived, developed and designed by Marcel Wanders for Moooi, the Boutique sofa is timeless. The Boutique sofa contours, dimensions and sheer comfort makes it highly sitter-friendly. With a unique artistic temperament and specially design fabrics & patters, it makes it the perfect sofa to brighten up your interior.

Boutique Sofa Double Seater

Dimensions

154cm | 60.6"

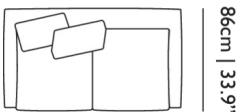

86cm | 33.9"

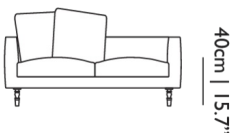

40cm | 15.7"

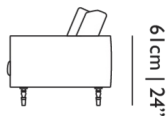

61cm | 24"

Product

WIDTH 154cm | 60.6"

HEIGHT 45cm | 17.7"

DEPTH 86cm | 33.9"

Packaging

WIDTH 88cm | 34.6"

HEIGHT 48cm | 18.9"

CUBAGE 0.65m³ | 22.97ft³

LENGTH 154cm | 60.6"

WEIGHT 59.1cm | 130.29lbs

Technical

MATERIAL

Steel base construction, CMHR foam upholstered, removable cover.

HEIGHT ARMREST

61cm | 24"

SEAT HEIGHT

40cm | 15.7"

SEATING CAPACITY

2

SEAT DEPTH

69cm | 27.2"

SEAT WIDTH

129cm | 50.8"

Boutique Sofa Triple Seater

Dimensions

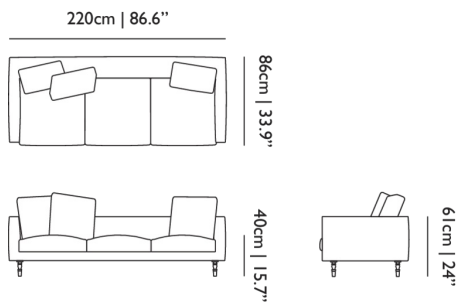

Product

WIDTH 220cm | 86.6"**HEIGHT** 45cm | 17.7"**DEPTH** 86cm | 33.9"

Packaging

WIDTH 88cm | 34.6"**HEIGHT** 48cm | 18.9"**CUBAGE** 0.93m³ | 32.82ft³**LENGTH** 220cm | 86.6"**WEIGHT** 72cm | 158.73lbs

Technical

MATERIAL

Steel base construction, CMHR foam upholstered, removable cover.

HEIGHT ARMREST

61cm | 24"

SEAT DEPTH

69cm | 27.2"

SEAT HEIGHT

40cm | 15.7"

SEAT WIDTH

195cm | 76.8"

Upholstery

ABBRACCI (available in 5 colours)

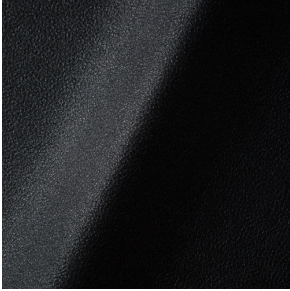

COMPOSITION
100% PES

ABRASION
30000 martindale
lightfastness 3 - 4
pilling 5

FIRETEST
BS5852 part 1 on request
TB117-2013

ARREDO (available in 2 colours)

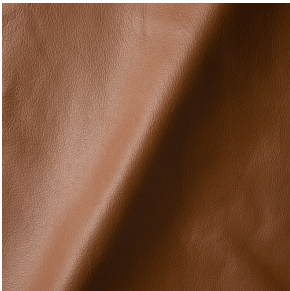

BOUCLE (available in 4 colours)



COMPOSITION
43% CO, 14% PA, 12% CV,
3% PES, 28% PAN

ABRASION
20000 martindale
lightfastness 4 - 6
pilling 4 - 5

FIRETEST
BS5852 part 1 on request

BYRAM (available in 19 colours)



COMPOSITION
100% WM

ABRASION
70000 martindale
lightfastness 4 - 5
pilling 4

FIRETEST
BS5852 part 1
TB117-2013

CANVAS 2 (available in 45 colours)



COMPOSITION

90% WO, 10% PA

ABRASION

100000 martindale
lightfastness 6
pilling 4

FIRETEST

BS5852 part 1 on request
TB117-2013

CERVINO (available in 5 colours)

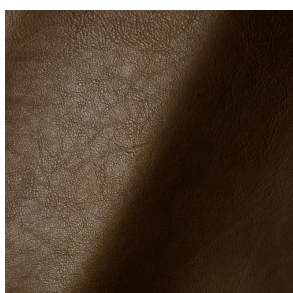

DENIM (available in 3 colours)

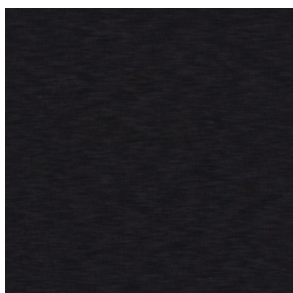

COMPOSITION

100% CO

ABRASION

70000 martindale
lightfastness 4
pilling 3 - 4

FIRETEST

BS5852 part 1 on request
TB117-2013

DIVINA 3 (available in 56 colours)

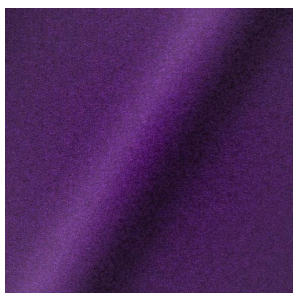

COMPOSITION

100% WO

ABRASION

45000 martindale
lightfastness 7
pilling 3

FIRETEST

BS5852 part 1 on request
TB117-2013

DIVINA MD (available in 27 colours)

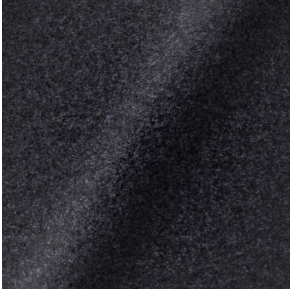

COMPOSITION
100% WO

ABRASION
45000 martindale
lightfastness 6
pilling 3

FIRETEST
BS5852 part 1 on request
TB117-2013

DIVINA MELANGE 3 (available in 60 colours)



COMPOSITION
100% WO

ABRASION
45000 martindale
lightfastness 6 - 7
pilling 3

FIRETEST
BS5852 part 1 on request
TB117-2013

Bearded Leopard (available in 2 colours)

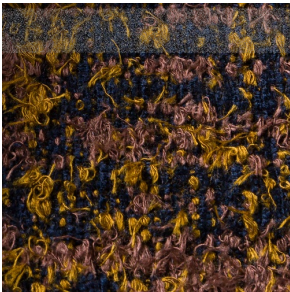

COMPOSITION
77% CV, 15% PES, 7% CO,
1% PA

ABRASION
15000 martindale
lightfastness 4 - 6
pilling 4

FIRETEST
BS5852 part 1 on request
TB117-2013

Bison (available in 1 colours)

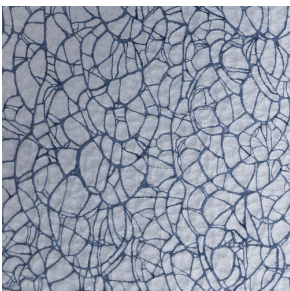

Armoured Boar, Cracked (available in 1 colours)

Armoured Boar, Hairy (available in 1 colours)



Armoured Boar (available in 2 colours)

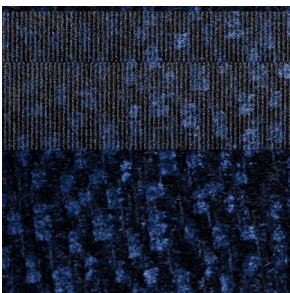

COMPOSITION

64% CV, 21% PES, 15%
CO

ABRASION

50000 martindale
lightfastness 4 - 6
pilling 5

FIRETEST

BS5852 part 1 on request
TB117-2013

Dodo Pavone (available in 2 colours)



COMPOSITION

12% CO, 88% PES

ABRASION

40000 martindale
lightfastness 5
pilling 4 - 5

FIRETEST

BS5852 part 1 on request
TB117-2013

Dwarf Rhino Buffed (available in 1 colours)



Dwarf Rhino, Crackle (available in 1 colours)

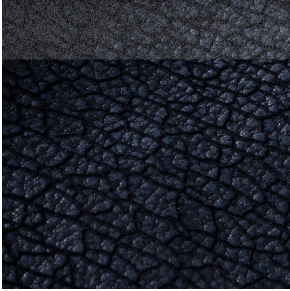

Menagerie of Extinct Animals (available in 2 colours)



COMPOSITION

100% PES

ABRASION

50000 martindale
lightfastness 4 - 6
pilling 5

FIRETEST

BS5852 part 1 on request
TB117-2013

Blushing Sloth Melange Mohair (available in 1 colours)



COMPOSITION

85% WV, 15% WM

ABRASION

15000 martindale
lightfastness 4 - 6
pilling 2 - 3

FIRETEST

BS5852 part 1 on request
TB117-2013

Blushing Sloth Woolly Mohair (available in 2 colours)



COMPOSITION

24% PES, 15% PA, 8% CO,
24% WM, 29% WV

ABRASION

40000 martindale
lightfastness 4 - 6
pilling 3 - 4

FIRETEST

BS5852 part 1 on request
TB117-2013

FIORD (available in 27 colours)

COMPOSITION

92% WV, 8% PA

ABRASION

60000 martindale
lightfastness 6
pilling 4 - 5

FIRETEST

BS5852 part 1 on request
TB117-2013

HALLINGDAL 65 (available in 58 colours)

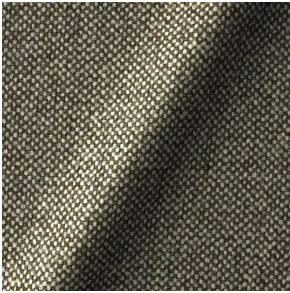

COMPOSITION

30% CV, 70% WV

ABRASION

100000 martindale
lightfastness 7
pilling 3 - 4

FIRETEST

BS5852 part 1

HARALD 3 (available in 30 colours)

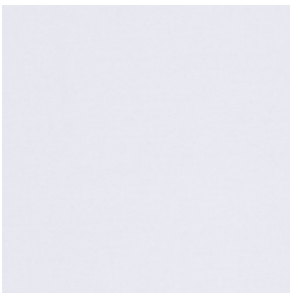

COMPOSITION

100% CO

ABRASION

100000 martindale
lightfastness 5
pilling 4 - 5

FIRETEST

JACQUARD, ANDAZ (available in 3 colours)

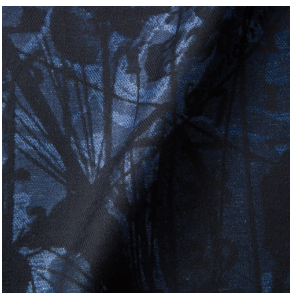

COMPOSITION

34% CO, 30% CV, 24%
LI, 12% PA

ABRASION

25000 martindale
lightfastness 4 - 6
pilling 4 - 5

FIRETEST

BS5852 part 1 on request
TB117-2013

JACQUARD, FRESC (available in 2 colours)



COMPOSITION

52% CV, 38% CO, 10% LI

ABRASION

15000 martindale
lightfastness 3 - 4
pilling 2 - 3

FIRETEST

BS5852 part 1 on request
TB117-2013

JACQUARD, OLD (available in 4 colours)

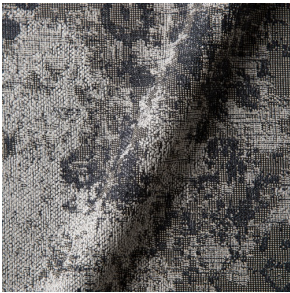

COMPOSITION

52% CV, 38% CO, 10% LI

ABRASION

15000 martindale
lightfastness 3 - 4
pilling 2 - 3

FIRETEST

BS5852 part 1 on request
TB117-2013

JUSTO (available in 10 colours)



COMPOSITION

15% CO, 35% PC, 10% PA,
40% CV

ABRASION

50000 martindale
lightfastness 5
pilling 4

FIRETEST

BS5852 part 1 on request
TB117-2013

LISCIO (available in 23 colours)

COMPOSITION

35% WO, 35% CV, 21%
CO, 9% PA

ABRASION

30000 martindale
lightfastness 4 - 6
pilling 4

FIRETEST

BS5852 part 1 on request
TB117-2013

MACCHEDIL GREZZO (available in 21 colours)

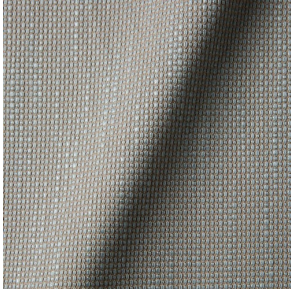

COMPOSITION

47% CO, 20% CV, 18%
PA, 8% LI, 5% PC

ABRASION

15000 martindale
lightfastness 3 - 5
pilling 4 - 5

FIRETEST

BS5852 part 1 on request

MACCHEDIL SOTTILE (available in 11 colours)

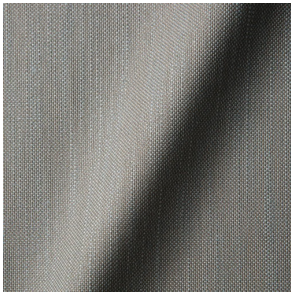

COMPOSITION

49% CV, 24% PES, 21% LI,
6% CO

ABRASION

20000 martindale
lightfastness 3 - 5
pilling 2 - 3

FIRETEST

BS5852 part 1 on request

MERIT (available in 43 colours)

COMPOSITION

24% PES, 76%

ABRASION

85000 martindale
lightfastness 7
pilling 4

MOSAIC 2 (available in 15 colours)

COMPOSITION

58% PES, 27% WV, 9% PA,
6% EA

ABRASION

100000 martindale
lightfastness 6 - 7
pilling 4 - 5

ORAY RAY (available in 31 colours)

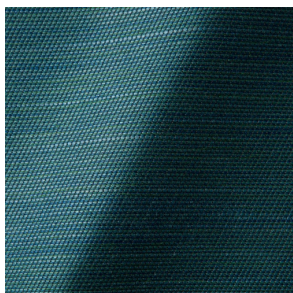

COMPOSITION

39% LI, 38% CV, 15% PE,
8% CO

ABRASION

30000 martindale
pilling 4 - 5

FIRETEST

BS5852 part 1 on request
TB117-2013

ORAY RONAN (available in 11 colours)

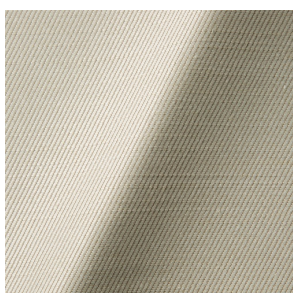

COMPOSITION

39% LI, 38% CV, 15% PE,
8% CO

ABRASION

30000 martindale
pilling 4 - 5

FIRETEST

BS5852 part 1 on request
TB117-2013

REMIX 2 (available in 49 colours)



COMPOSITION

90% WV, 10% PA

ABRASION

100000 martindale
lightfastness 5
pilling 4

FIRETEST

TB117-2013

SOLIS (available in 18 colours)



COMPOSITION

60% WO, 30% PES, 2%
PA, 3% PC

ABRASION

40000 martindale
lightfastness 5
pilling 3 - 4

FIRETEST

BS5852 part 1 on request
TB117-2013

STEELCUT 2 (available in 37 colours)

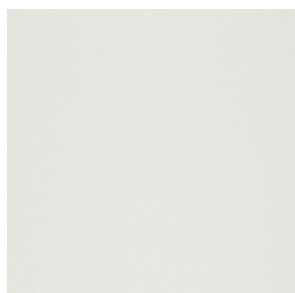

COMPOSITION

90% WV, 10% PA

ABRASION

100000 martindale
lightfastness 6
pilling 3 - 4

FIRETEST

TB117-2013

STEELCUT TRIO 3 (available in 54 colours)

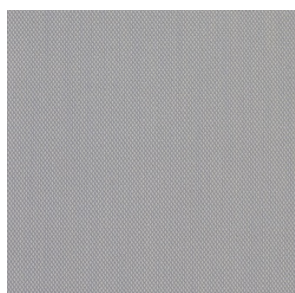

COMPOSITION

90% WV, 10% PA

ABRASION

100000 martindale
lightfastness 5
pilling 4

FIRETEST

TB117-2013

SUMMIT MELANGE (available in 9 colours)

SUMMIT UNI (available in 9 colours)

TONICA 2 (available in 39 colours)

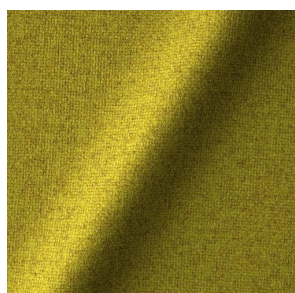

COMPOSITION

100% WV

ABRASION

45000 martindale
lightfastness 6 - 7
pilling 4 - 5

FIRETEST

TB117-2013

TRICKLE (available in 8 colours)

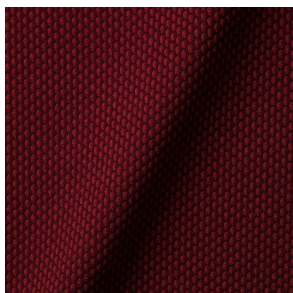

TWILL (available in 9 colours)

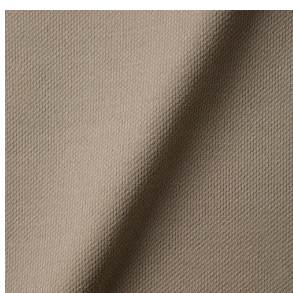

TWILL MELANGE (available in 9 colours)

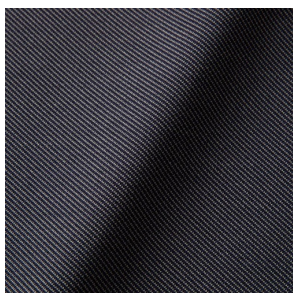

VESPER (available in 16 colours)



COMPOSITION

10% CO, 40% LI, 10% PA,
10% PES, 30% CV

ABRASION

40000 martindale
lightfastness 5
pilling 4

FIRETEST

BS5852 part 1 on request
TB117-2013