

PARACHILNA



THE BAI FAMILY
by Neri&Hu, 2014

THE BAI FAMILY

by Neri&Hu, 2014

It was summer 13 when we first got in touch with Lyndon Neri. We remember the date because it was dead hot in Spain at that time. We told him who we were and what PARACHILNA wanted to do. Right away we realized that we were on the same wavelength. The briefing was clear in the first five minutes because we were looking for something that we had always loved: Chinese lanterns. Tradition, function, memory, a rich and millenarian culture.

The tricky line in the briefing was that we were looking for an updated version of a Chinese lantern.

Lyndon Neri & Rosanna Hu are...well, they are Neri & Hu, useless to say more. They came up with a project that looked like bespoke for PARACHILNA. Paper became blown glass, wires became a solid metalwork finished in aged bronze and the candle became a LED engine. We found there all the elements of our company's DNA: rich quality materials, craftsmanship and contemporary design.

The project took longer than expected to become real. Mainly because we enjoyed the learning experience of realizing that a one millimeter variation can be instrumental to the final result of the project. We were both overwhelmed and pleased for the extremely thorough and detailed work of Neri & Hu.

The big sizes of the glasses were extremely demanding from the very beginning, as neither did we want to concede an inch in terms of quality of the glass, nor were we ready to renounce to a preferred craft technique as blown glass. Luckily enough, when you have tests like this, you can count on Jan Rabell's mastership. The craftsmen working in his factory in Czech Republic can manage the most arduous pieces.

Blown glass requires an open understanding of the word "tolerance" as its craftsmanship production makes every single piece unique. That is the reason why the expertise and understanding of Carles, our metalsmith, is essential, because he will manufacture the metal body taking into account the glass tolerance. The uniqueness of each piece is also the reason why the aged bronze finishing stubbornly searches the "perfect imperfect" surface.

The inner glass tube is central in Neri & Hu design as traditional Chinese lanterns hide what is inside while Neri & Hu's lantern strip and unveil the inside, making it public. Four LED strips guarantee that the spin of the lamp is lit but does not overlights or glares. A 17 W LED board at the bottom casts the right amount of light on the task plan.

The final result is a journey to the past times of a millenarian culture by the hand of a 21st century technology.

BAI is a family of three hanging lamps of different shapes and sizes. The smallest size can be combined in 2 x or 3 x chandeliers (although our favorite is a 5 x DIY combinaton...).

BAI is one of those families that would like to grow bigger...so keep posted to eventual new brothers and sisters!

PARACHILNA



BAI MA MA
by Neri&Hu, 2014

BAI MA MA

by Neri&Hu, 2014

Suspension lamp. Structure and canopy in bronze electroplated steel. Diffuser in blown transparent, amber and grey glass. Strip LED column and module LED placed at the bottom of the luminaire*.

Lámpara de suspensión. Estructura y florón en acero acabado en baño electrolítico bronce. Difusor en cristal soplado transparente, ámbar o gris. Columna de strip LED con módulo LED en la parte inferior de la luminaria*.

Type: Suspension lamp

Tipo: Lámpara de suspensión

Environment: Indoor

Ámbito de utilización: Interior

Structure: Steel

Estructura: Acero

Diffuser: Glass

Difusor: Cristal

Voltage: 230 V

Voltaje: 230 V

Supply: Terminal strip

Alimentación: Regleta

Cable length: 2,5 m

Longitud de cable: 2,5 m

Light Source / fuente de luz:

One lit / Un encendido

1 module LED diam.70 - 17W, 2700°K. 1400Lm
+ strip LED 4,8W, 2700°K 350Lm.



Two lit / Dos encendidos:

1 module LED diam.70 - 17W, 2700°K. 1400Lm
and strip LED 4,8W, 2700°K 350Lm.

***For dimmable options please contact info@parachilna.eu**

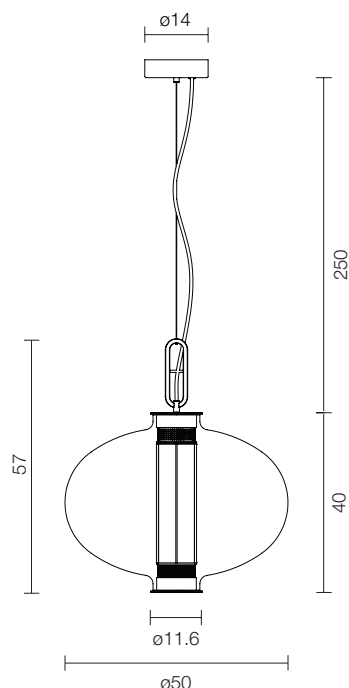
*Para opciones de dimmerización consultar info@parachilna.eu



CE   IP-20

 x,x kg
xx,x kg

BAI MA MA

115000600018 **electric group** / grupo eléctrico

603000000019 **diffuser transparent** / difusor transparente

603000000020 **diffuser grey** / difusor gris

603000000021 **diffuser amber** / difusor ámbar

PARACHILNA



BAI BA BA
by Neri&Hu, 2014

BAI BA BA

by Neri&Hu, 2014

Suspension lamp. Structure and canopy in bronze electroplated steel. Diffuser in blown transparent, amber and grey glass. Strip LED column and module LED placed at the bottom of the luminaire*.

Lámpara de suspensión. Estructura y florón en acero acabado en baño electrolítico bronce. Difusor en cristal soplado transparente, ámbar o gris. Columna de strip LED con módulo LED en la parte inferior de la luminaria*.

Type: Suspension lamp

Tipo: Lámpara de suspensión

Environment: Indoor

Ámbito de utilización: Interior

Structure: Steel

Estructura: Acero

Diffuser: Glass

Difusor: Cristal

Voltage: 230 V

Voltaje: 230 V

Supply: Terminal strip

Alimentación: Regleta

Cable length: 2,5 m

Longitud de cable: 2,5 m

Light Source / fuente de luz:

One lit / Un encendido

1 module LED diam.70 - 17W, 2700°K. 1400Lm
+ strip LED 7,7W, 2700°K 560Lm.



Two lit / Dos encendidos:

1 module LED diam.70 - 17W, 2700°K. 1400Lm
and strip LED 7,7W, 2700°K 560Lm.

***For dimmable options please contact info@parachilna.eu**

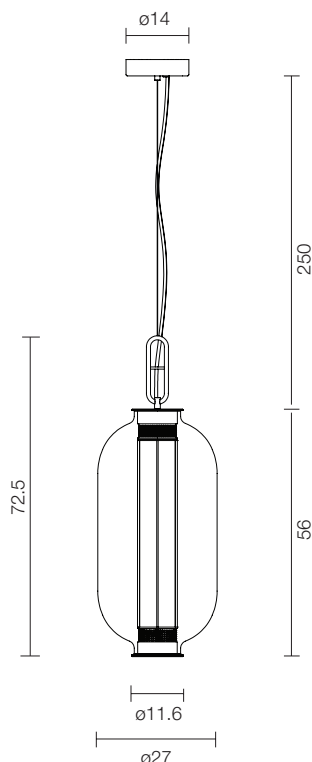
*Para opciones de dimmerización consultar info@parachilna.eu



CE   IP-20

 x,x kg
xx,x kg

BAI BA BA

116000600018 **electric group** / grupo eléctrico

604000000019 **diffuser transparent** / difusor transparente

604000000020 **diffuser grey** / difusor gris

604000000021 **diffuser amber** / difusor ámbar

PARACHILNA



BAI DI DI
by Neri&Hu, 2014

BAI DI DI

by Neri&Hu, 2014

Suspension lamp. Structure and canopy in bronze electroplated steel. Diffuser in blown transparent, amber and grey glass. Strip LED column*.

Lámpara de suspensión. Estructura y florón en acero acabado en baño electrolítico bronce. Difusor en cristal soplado transparente, ámbar o gris. Columna de strip LED*.

Type: Suspension lamp

Tipo: Lámpara de suspensión

Environment: Indoor

Ámbito de utilización: Interior

Structure: Steel

Estructura: Acero

Diffuser: Glass

Difusor: Cristal

Voltage: 230 V

Voltaje: 230 V

Supply: Terminal strip

Alimentación: Regleta

Cable length: 2,5 m

Longitud de cable: 2,5 m

Light Source / Fuente de luz:

Strip LED 7,7W, 2700°K 560Lm.

***For dimmable options please contact info@parachilna.eu**

*Para opciones de dimmerización consultar info@parachilna.eu

 x,x kg
xx,x kg

BAI DI DI



114000600018 **electric group** / grupo eléctrico

602000000019 **diffuser transparent** / difusor transparente

602000000020 **diffuser grey** / difusor gris

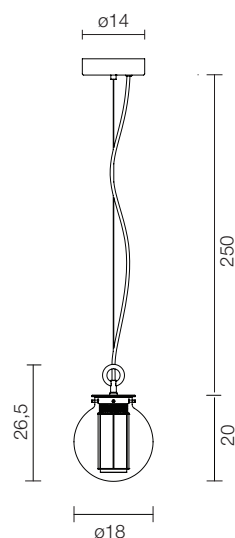
602000000021 **diffuser amber** / difusor ámbar



CE   IP-20

PARACHILNA



BAI CHANDELIER COMBINATION
by Neri&Hu, 2014

PARACHILNA



BAI CHANDELIER II
by Neri&Hu, 2014

BAI CHANDELIER II

by Neri&Hu, 2014

Suspension lamp. Structure and canopy in bronze electroplated steel. Diffuser in blown transparent, amber and grey glass. Strip LED column*.

Lámpara de suspensión. Estructura y florón en acero acabado en baño electrolítico bronce. Difusor en cristal soplado transparente, ámbar o gris. Columna de strip LED*.

Type: Suspension lamp

Tipo: Lámpara de suspensión

Environment: Indoor

Ámbito de utilización: Interior

Structure: Steel

Estructura: Acero

Diffuser: Glass

Difusor: Cristal

Voltage: 230 V

Voltaje: 230 V

Supply: Terminal strip

Alimentación: Regleta

Cable length: 2,5 m

Longitud de cable: 2,5 m

Light Source / Fuente de luz:

2 x Strip LED 7,7W, 2700°K 560Lm.

***For dimmable options please contact info@parachilna.eu**

***Para opciones de dimmerización consultar info@parachilna.eu**

 x,x kg
xx,x kg

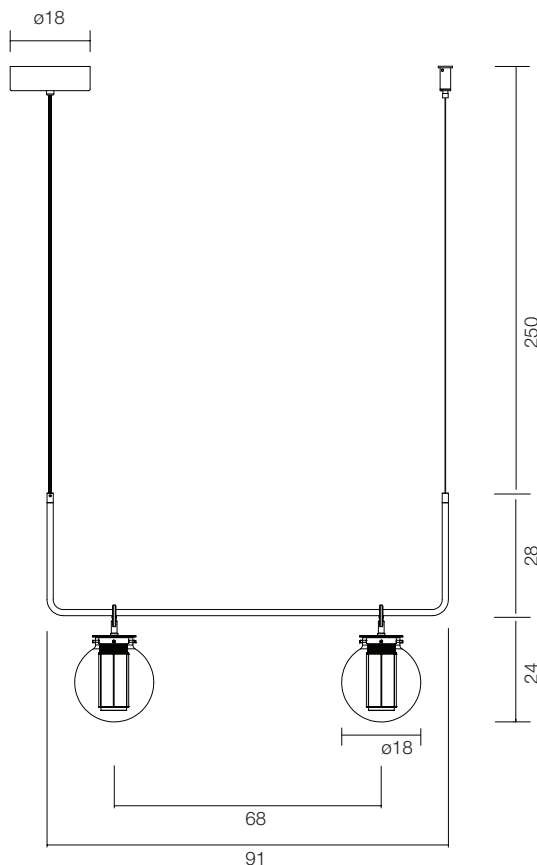



BAI CHANDELIER II

117000600018 **electric group** / grupo eléctrico

602000000019 **diffuser transparent** / difusor transparente

602000000020 **diffuser grey** / difusor gris

602000000021 **diffuser amber** / difusor ámbar

CE   IP-20

PARACHILNA



BAI CHANDELIER III
by Neri&Hu, 2014

BAI CHANDELIER III

by Neri&Hu, 2014

Suspension lamp. Structure and canopy in bronze electroplated steel. Diffuser in blown transparent, amber and grey glass. Strip LED column*.

Lámpara de suspensión. Estructura y florón en acero acabado en baño electrolítico bronce. Difusor en cristal soplado transparente, ámbar o gris. Columna de strip LED*.

Type: Suspension lamp

Tipo: Lámpara de suspensión

Environment: Indoor

Ámbito de utilización: Interior

Structure: Steel

Estructura: Acero

Diffuser: Glass

Difusor: Cristal

Voltage: 230 V

Voltaje: 230 V

Supply: Terminal strip

Alimentación: Regleta

Cable length: 2,5 m

Longitud de cable: 2,5 m

Light Source / Fuente de luz:

3 x Strip LED 7,7W, 2700°K 560Lm.

***For dimmable options please contact:**



info@parachilna.eu

*Para opciones de dimmerización consultar:

info@parachilna.eu

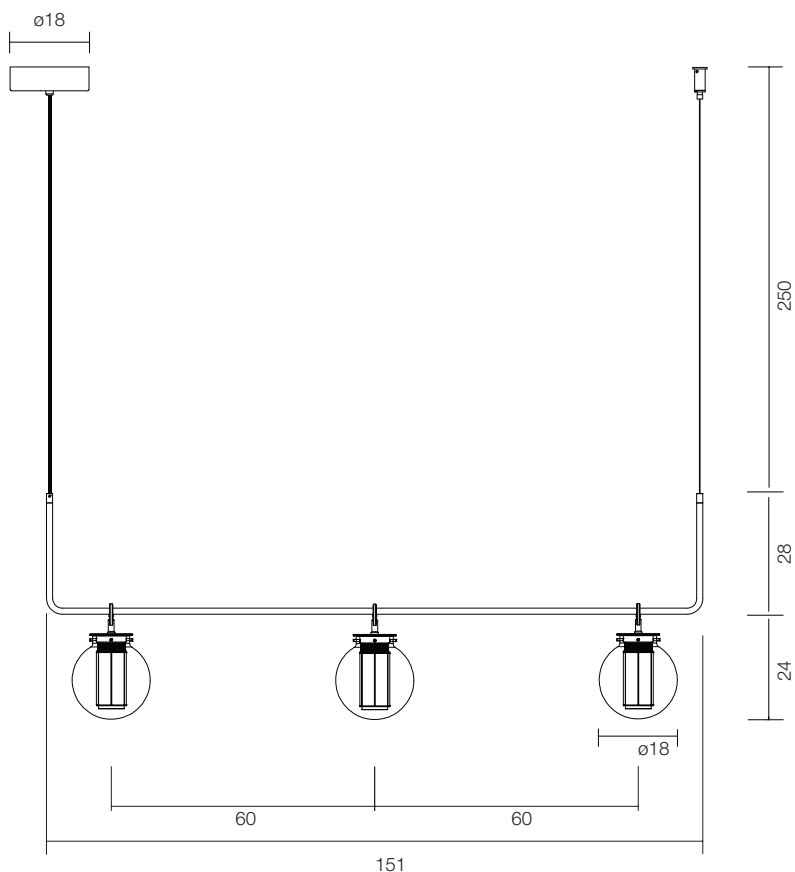
 x,x kg
xx,x kg



CE   IP-20

BAI CHANDELIER III

118000600018 **electric group**/ grupo eléctrico

602000000019 **diffuser transparent** / difusor transparente

602000000020 **diffuser grey** / difusor gris

602000000021 **diffuser amber** / difusor ámbar