

AUKI
design Hee Welling
2015



An elegant curved surface that follows the body is the basic idea of this lounge chair with an essential and clean line. The gentle contour outlines the armrests and the headrest and foot-rest make it almost a chaise-longue extremely comfortable. Auki family is enriched by different legs and low tables (round or square with top in HPL Fenix® or wood) which make it perfect for the lounge area.



AUKI



AUKI





AUKI



AUKI

design Hee Welling
2015

Lounge chair in fire-retardant moulded polyurethane foam upholstered with fabric, leather or ecoleather. Four legged base in metal or ash, swivel 4-star base or metal plate powder coated or mat chrome. Self levelling glides with felt. Headrest also available. Footstool with moulded fire-retardant foam upholstered in fabric, leather or ecoleather. Four star metal base powder coated or mat chromed or with wooden legs. Coffee table with metal base powder coated or mat chromed. Tops in several dimensions and finishes.

lounge chairs and footstools

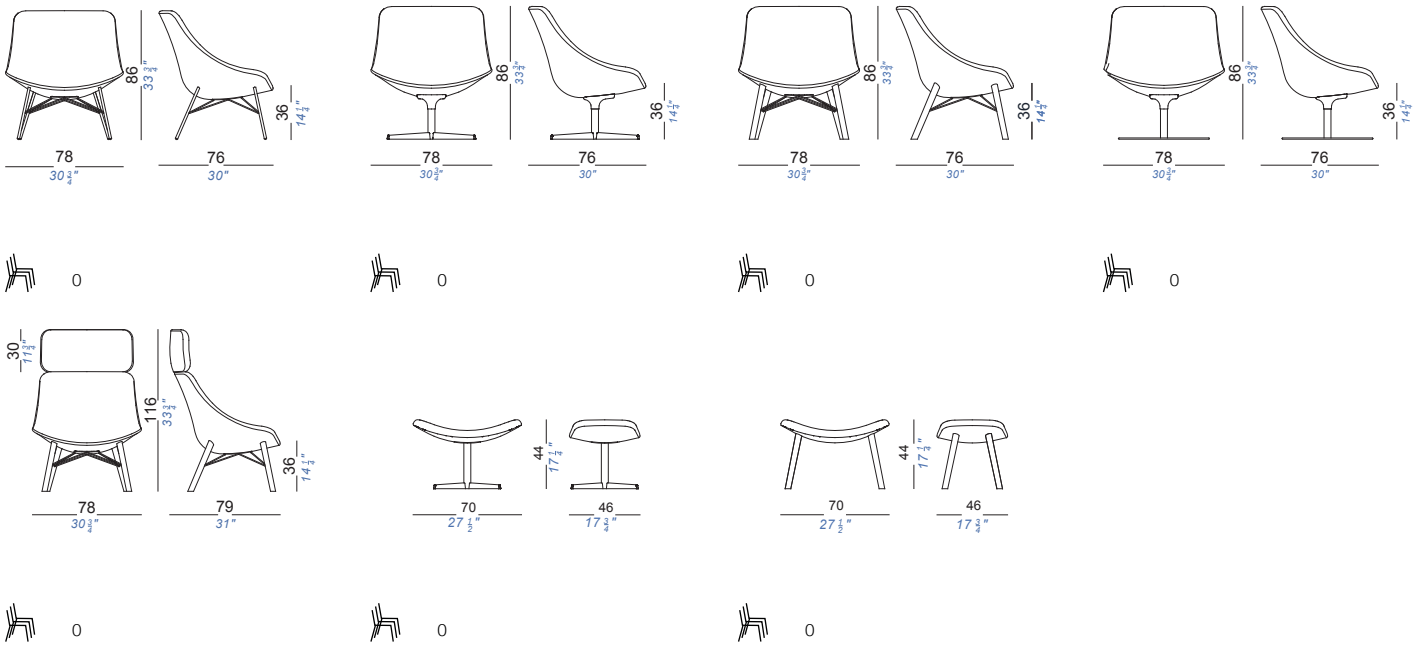







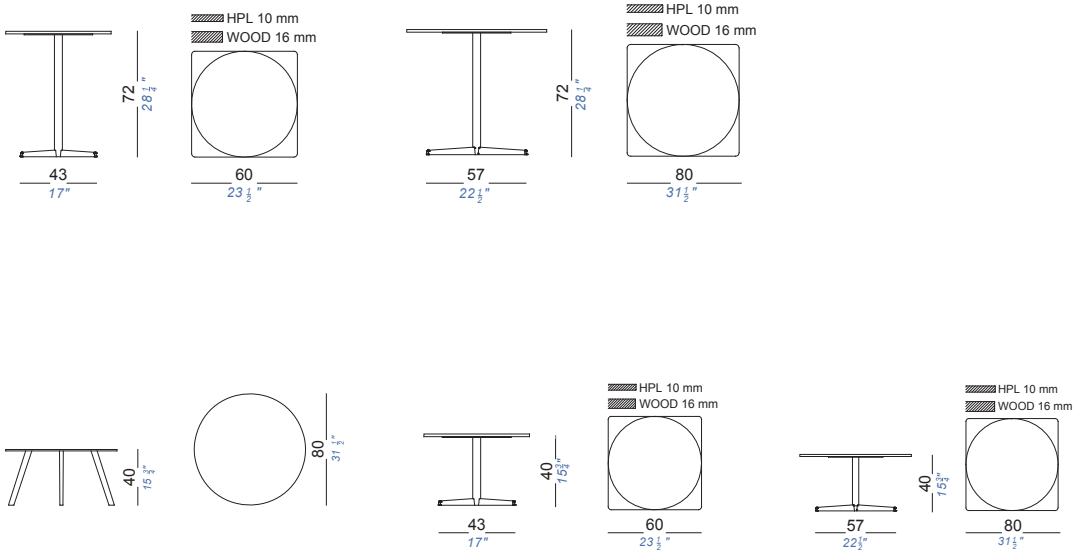

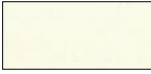

frame		upholstery					
	powder coated: black		fabric: Hallingdal 65 58 colors		fabric: Divina MD 27 colors		fabric: Jet 66 colors
	powder coated: white		fabric: Remix 2 49 colors		fabric: Divina Melange 2 24 colors		soft-leather 7 colors
	mat chromed		fabric: Cava 3 49 colors		fabric: Medley 37 colors		eco-leather 10 colors
	black open pore		fabric: Steelcut Trio 2 49 colors		fabric: Swing 29 colors		
	natural ash		fabric: Steelcut 2 37 colors		fabric: Maya 43 colors		
	stainless steel		fabric: Clara 2 24 colors		fabric: Style 28 colors		

consult the portfolio for the range of colors, fabrics, eco-leather, soft-leather.

tables

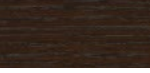
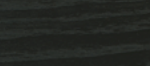
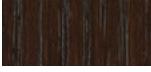
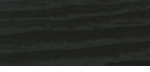

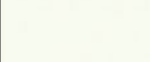
frame		top			
	powder coated: black		white laminate		HPL fenix white
	powder coated: white		HPL white		blanched oak
	mat chromed		HPL blanch oak		oak dark walnut
	black open pore		HPL oak stained walnut		black open pore
	natural ash		HPL fenix black		white lacquered

use and maintenance instructions

Clean all parts in wood, leather, fabric and metal with a damp cloth or a diluted neutral cleaner. Do not use cleaners with alcohol, bleach, solvent or abrasive products. Any liquid spill on the product must be wiped up immediately. When lifting or moving the product, hold it on the structure and not under the seat. The product should not be subjected to unbalanced weights, as it is designed for a proper rest on the foothold (on four legs or on the base). Our company relieves from any responsibility in case of damage caused to fragile floors. Avoid any improper use of the product: do not step on the product, on the footrest or on the armrests. Avoid any movements that could compromise the proper functionality of the product or the safety of the users. Wood and leather, being natural materials, could be easily damaged. Small impurities or imperfections are within quality standard range. Do not expose the product to weather conditions or atmospheric agents, nor to heat sources over 40°C. Also products for outdoor use could be afflicted by atmospheric agents. The product could undergo possible exterior changes due to particular exposure to heat, humidity and saltiness. An appropriate and frequent maintenance and cleaning of the product enhances its durability. The product could change colour and shade, if exposed to direct sunlight. Maintenance has to be carried out by experienced staff. Dispose of the package only after assembling the product, in order to avoid the loss of ironmongery and components. Once the product has been dismantled, the product itself or its components must be given to the public garbage disposal system, according to the legislation in force.