



**Struttura:** in legno tamburato monoscocca.

**Preparazione della struttura:** poliuretano espanso a quote differenziate ad alta densità.

**Cuscinatura:** imbottitura cuscino seduta in piuma d'oca canalizzata ad alto spessore per conferire grande soffici ta al cuscino. Inserto in poliuretano espanso ad alta resilienza, rivestito nella parte superiore con materiale poliuretano "termosensibile". **LA CONFEZIONE DEL CUSCINO DI SEDUTA E DELLA FODERA VENGONO REALIZZATI CON UNA LEGGERA E MODERNA TRAPUNTATURA.** Cuscini schienale totalmente imbottiti in piuma d'oca canalizzata.

**Braccioli:** rivestiti sul lato interno con trapuntino in piuma d'oca canalizzata che conferisce morbidezza e soffici ta dando al bracciolo l'aspetto di un cuscino.

**Base:** realizzata con telaio in metallo a sezione rettangolare 30x15 mm con finitura color Peltro (tonalit  ideata da Minotti Studio). Appoggio a terra tramite piedini (disegnati e progettati da Minotti Studio) stampati in metallo pressofuso colore Peltro con finitura extra-lucida anti-touch. Questi piedini sono in grado di resistere a circa 300 ore di nebbia salina (salsedine marina) e sono resistenti a graffi, sostanze chimiche, urti (data la loro notevole plasticit ) e ai raggi ultravioletti. Scivolante protettivo in Hytrel® (gomma morbida antigraffio).

**Sfoderabilit :** il rivestimento   completamente sfoderabile nella versione in tessuto smontando la base perimetrale portante allentando le apposite manopole. Nella versione in pelle il rivestimento   fisso solo per la struttura, mentre   sfoderabile per i cuscini schienale e seduta.

**Frame:** one-piece sandwich wood frame.

**Frame preparation:** let into high-density polyurethane foam in different densities.

**Cushions:** thick seat cushion padding in goose down divided into sections, for increased cushion softness. Resilient polyurethane foam insert, covered - in the upper part - with "thermosensitive" polyurethane material. **THE SEAT CUSHION AND COVER ARE MADE WITH A LIGHT, MODERN QUILT.** Backrest cushions fully padded with goose down divided into sections.

**Armrests:** internal side covered with quilted goose down divided into sections, which results in enhanced softness, thereby making the armrests look like cushions.

**Base:** fitted with metal frame, rectangular section, 30x15 mm; Pewter-coloured finish (shade devised by Minotti Studio). Feet (designed by Minotti Studio), die-cast metal pressed, pewter-coloured; ultra-glossy, anti-touch finish. These feet can withstand saline mist (sea salt) for approximately 300 hours and are resistant to scratches, chemical substances, shocks (due to their plasticity) and UV rays. Protective glides made of Hytrel® (soft, scratch-proof rubber).

**Covers:** fully removable in the fabric version by taking the external supporting base apart, loosening the knobs. Leather cover of the frame non-removable; removable backrest and seat cushion covers.

**Rahmen:** Struktur aus Sperrholzschalen.

**Herstellung des Rahmens:** mit unterschiedlich dick gesch umtem, hoch-dichtem Polyurethan.

**Kissen:** Dickes Sitzkissenpolster aus kanalisierten G nsedaunen, durch die das Kissen sehr locker wirkt. Einsatz aus hoch kerbz hem, gesch umtem Polyurethan und Oberseitenpolsterung mit "w rmesensiblen" Polyurethanmaterial. **DAS SITZKISSEN UND DER BEZUG WERDEN MIT EINER LEICHTEN, MODERNEN STEPPDECKE BEZOGEN.** Komplet mit kanalisierten G nsedaunen gef utterte R ckenlehnenkissen.

**Armlehne:** an der Innenseite mit einem Steppbezug aus kanalisierten G nsedaunen bezogene Armlehnen, die weich und locker wirken, was der Armlehne das Aussehen eines Kissens verleiht.

**Gestell:** aus einem Metallrahmen mit rechteckigem Schnitt 30x15 mm und zinnfarbenem Finish (von Minotti Studio erfundener Farbton). Bodenaufgabe durch (von Minotti Studio entworfene und entwickelte) F u e, die im Metalldruckgussverfahren gegossen und mit einem zinnfarbenen Extraglanzack endgefertigt werden. Diese F u e sind ungef ahr 300 Stunden gegen Salznebel (Meeressalz) best ndig und sind kratzsicher, chemikalienbest ndig, sto fest (aufgrund ihrer herausragenden Formbarkeit) und UV-strahlenbest ndig. Gleitschutz aus Hytrel® (weicher, kratzsicherer Gummi).

**Abnehmbare Bez ge:** Nur der Stoffbezug ist abziehbar. Hierzu wird das umlaufende tragende Grundgestell nach vorheriger Lockerung der Kugelgriffe demontiert. Fester Lederbezug nur f ur das Gestell.

**Structure :** en bois contreplaqu  mono-coque.

**Pr paration de la structure:** en polyur thane expans    hauteurs diff erenti es haute densit .

**Coussins :** le rembourrage du coussin d'assise en plumes d'oie   secteurs   haute  paisseur conf ere une grande souplesse au coussin.  l ment en polyur thane expans    haute r silience, rev tu dans la partie sup rieure avec un mat riau polyur thane "thermosensible". **LA CONFECTION DU COUSSIN D'ASSISE ET CELLE DE LA DOUBLURE SONT R ALIS ES AVEC UN L GER MATELASSAGE MODERNE .** Les coussins du dossier sont enti rement rembourr s en plumes d'oie   secteurs.

**Accoudoirs :** le c t  int rieur est matelass  en plumes d'oie   secteurs pour plus de douceur et de moelleux, ce qui les transforment en de v ritables coussins.

**Base :** r alis e avec ch assis en m tal de section rectangulaire 30x15 mm avec finition couleur  tain (tonalit  con ue par Minotti Studio). Pi tement (con u et r alis  par Minotti Studio) en acier moul  sous pression, couleur  tain avec finition ultra brillante anti-touch. Pi tement r sistant   environ 300 heures de brouillard salin (salinit  marine), aux  raflures, aux substances chimiques, aux chocs (en raison de leur incroyable plasticit ) et aux rayons ultraviolets. Patin de protection en Hytrel® (caoutchouc souple anti raflure).

**Possibilit  d'enlever la housse :** rev tement enti rement d houssable en tissu apr s d montage de la base p rim trale porteuse en desserrant les boutons molet s. Rev tement en cuir fixe pour la structure, coussins dossier et d'assise d houssables uniquement.

### FINITURA PIEDINI | FEET FINISH

### ALLUMINIO | ALUMINUM

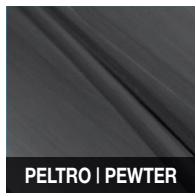

PELTRO | PEWTER

## DIVANO | SOFA

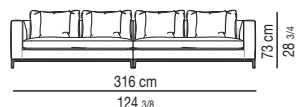
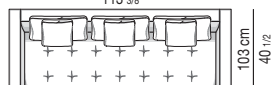
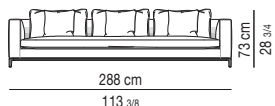
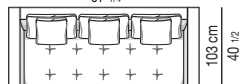
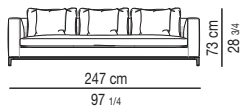
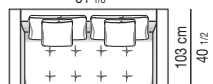
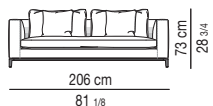
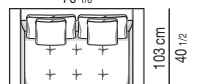
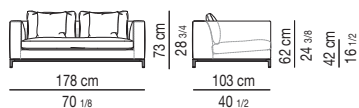

divano composto | two elements sofa

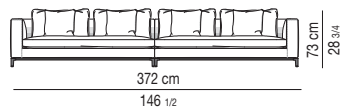

divano composto | two elements sofa

## ELEMENTO TERMINALE | ELEMENT WITH 1 ARMREST

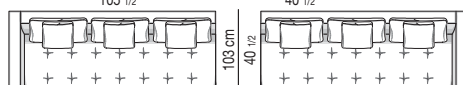
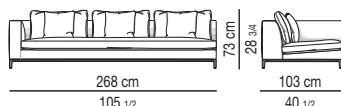
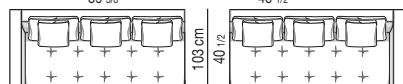
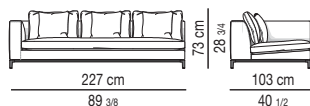
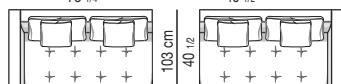
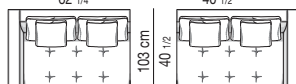
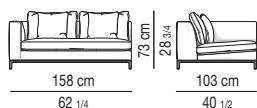

SX



SX

## DIVANO ANGOLARE PENISOLA OPEN-END CORNER SOFA

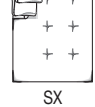
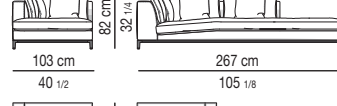
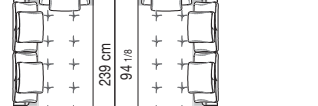
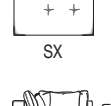
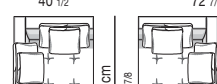
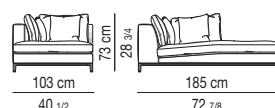

SX



DX

## ELEMENTO "SOFA" | "SOFA" ELEMENT

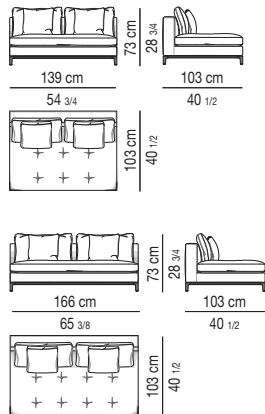

## ELEMENTO "SOFA" CON PENISOLA OPEN-END "SOFA" ELEMENT

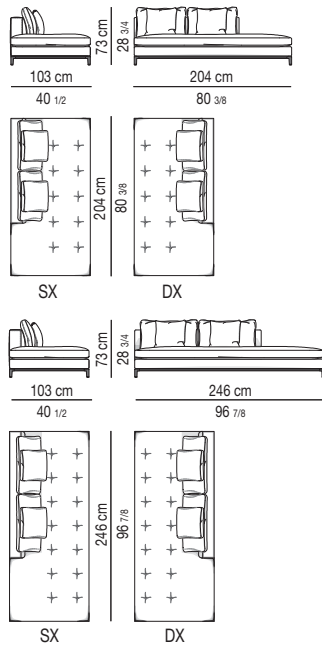
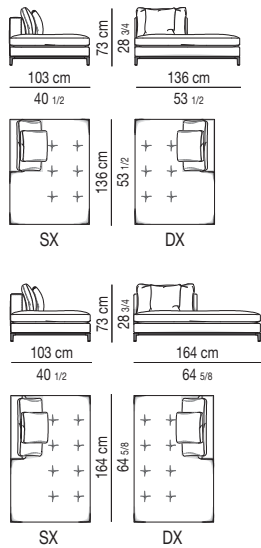

## ELEMENTO "SOFA" PENISOLA CON 1 BRACCIOLO OPEN-END "SOFA" ELEMENT WITH 1 ARMREST

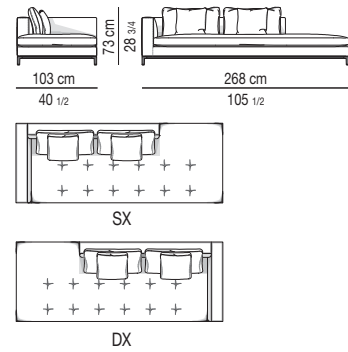

## CUSCINO OPTIONAL OPTIONAL CUSHION

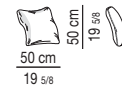

## ELEMENTO "SOFA" CON 1 BRACCIOLO "SOFA" ELEMENT WITH 1 ARMREST

