

STAT·CLEAN
STATIC ERASER CROSS-FLOW FAN

CF300-E

Thank you for purchasing our Stat Clean No.CF300-E.
Read this instruction manual before use. Keep it in a safe handy place for future reference.

Table of Contents

■For Your Safety	P.18
■Product Features	P.19
■Product Specifications	P.20
■External View	P.21
■Performance	P.22
■Installation	P.22
■Before Use	P.23
■Names and Functions	P.25
■Operation	P.26
■Maintenance	P.28
■Troubleshooting & Storage	P.31

■ For Your Safety

Safety Precautions

- Carefully read these Safety Precautions before use. Observe the precautions indicated herein to ensure safety.
- Safety precautions in this instruction manual are categorized into two types by the degree of danger associated with each of the followings. Based on danger analyses performed by VESSEL, all precautions in this instruction manual are of the CAUTION level.
- If the equipment is used in a manner not specified by the manufacturer, the protection provided by the equipment may be impaired.

**WARNING**

Indicates that improper handling can lead to serious injury or even death.

**CAUTION**

Indicates that improper handling can lead to minor injury and property damage.



This symbol indicates a WARNING or CAUTION.



This symbol indicates a prohibited action.



This symbol indicates a mandatory required action

WARNING

**PROHIBITED**

Do not use CF300-E in environments that require explosion-proofing. CF300-E is not of explosion-proof construction, therefore explosion or fire may occur.

CAUTIONS

**PROHIBITED**

Do not use CF300-E in flammable atmospheres. The corona discharge can act as an ignition source and cause an explosion or fire.

**PROHIBITED**

Do not use CF300-E in environments subjected to sharp temperature fluctuations or dewing. This kind of environment can lead to breakdown.

**DO NOT WET**

Do not use CF300-E in highly damp places or anywhere it may be wet by water, oil, solvent or other liquid. Contact with moisture can result in electric shock or breakdown.

**PROHIBITED**

Do not use CF300-E for anything other than static erasure or dust removal.

**PROHIBITED**

Do not use CF300-E with power supplies of ratings not specified in the specifications. Inappropriate power supplies can result in fire and electric shock.

**PROHIBITED**

Handle CF300-E with care to avoid giving it an impact: e.g. by dropping it.

**REMEMBER**

Keep this instruction manual in a safe handy place for future reference.

Product Features

● AC-TYPE CORONA DISCHARGE

The small-sized 20KHz coil transformer is installed for efficient ion generation.

● CROSS-FLOW FAN INSTALLED

The cross flow fan that generates wide and uniform air blow and the front cover that is designed considering the ion flow can help achieve excellent antistatic performance.

This is quieter than an axial fan type and creates a better working environment.

In addition, non-step airflow adjustment can be made, using the rotary control located on the front side.

● SAFE DESIGN

A slide-type cleaning brush is installed on the front cover, which is used for maintenance of the needle electrode at any time.

An easily-cleanable/-replaceable rough filter is installed on the bottom of the body.

● DESIGNED FOR SAFETY

The monitoring function for the abnormal stop of the fan motor and the stop caused by high voltage output is equipped.

The high voltage transformer unit has the output shutdown function that reduces output instantly if short circuit or overload occurs.

When an external notification device is connected to the alarm signal output terminal for fan lock (FAN ALARM) or high voltage malfunction (HV ALARM), it notifies the user if a malfunction occurs.

● LOW VOLTAGE INPUT

Safe and low voltage input of 24V DC is used. An internal DC power supply of automatic machines, etc. can be used.

● APPLICATIONS

For preventing troubles and dust adhesion caused by static electricity.

■ Product Specifications

Eraser

Model	: No.CF300-E
Ion generation method	: High voltage AC(20KHz) corona discharge
Input voltage	: 24 V DC±10%
Consumption current	: 500 mA (max)
Dimensions	: H157×W348×D165 (including stand) mm
Weight	: 2.9 kg
Fan speed	: 2.5 m ³ /min (Max. fan speed)
Noise emission	: 48 dB(A) Max. fan speed (Measured at 1m)
Ozone generation	: 0.05ppm or less
Warning output	: High voltage alarm (Red LED), Fan lock alarm (LED Light blinks)
Protective function	: Fan motor rotation monitoring function (Detecting rotation lock) High-voltage output shut down function (overload detection) Power fuse 3.15A
Working ambient temperature / humidity	:5 ~ 40°C / 35 ~ 65%RH (No dewing or freezing)
Ambient storage temperature / humidity	:0 ~ 60°C 35 ~ 85%RH(No dewing or freezing)
Distance from target area	:150 ~ 900mm (Installation location: Non-hazardous indoor location)
Static electricity removal time	: Refer to the items in the performance chart.
Ion balance	: Within ±10V (At 300mm ,at the time of shipment)
Air filter	: Rough filter
Material	:Casing and stand ... SPCC, :Front cover ... ABS, :Electrode ... Inconel

Accessories

Adapter No.AD24-ITE	
Rated input voltage	:100-240V AC (50/60Hz) 0.4A
Rated output voltage	:24V DC 0.75A
Working temperature /humidity	:0~40°C 10~85%RH (No dewing or freezing)
Cable length	:DC input cable:1.8 m , AC output cable:1.8m

*The measurement values were obtained under the VESSEL measurement environment, so error could be induced depending on the operation environment.

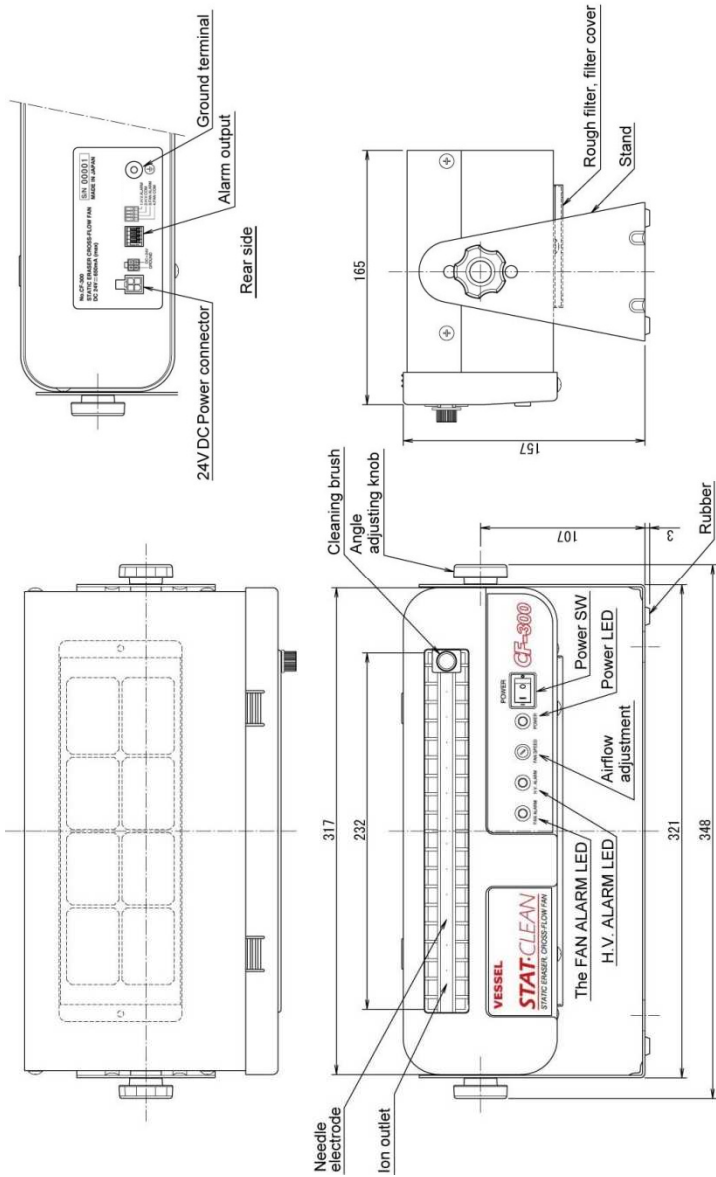

■ Performance

Diagram of capacity area

Static electricity removal performance

Static electricity removal time: Time required to reduce charge electric potential from ± 1000 V to ± 100 V.

Relation between the distance to the charged object and the static electricity removal time

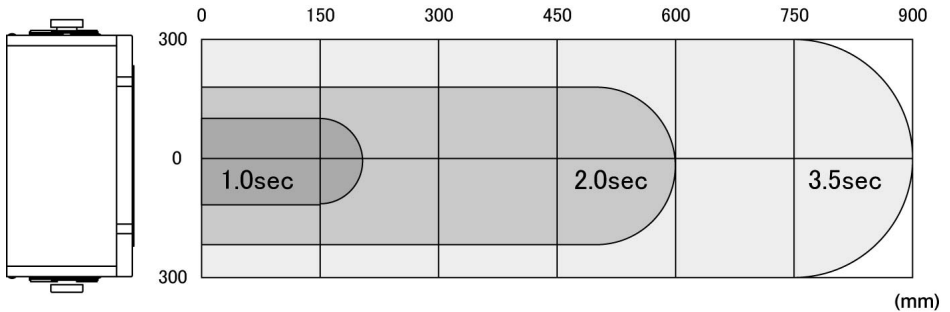

■ Installation

⚠ CAUTIONS IN INSTALLATION

● REMEMBER	Use only the included power supply adapter. Use of other adapters may result in fire, electric shock and static electricity removal trouble.
● REMEMBER	Install CF300-E securely. CF300-E can be damaged or malfunctioned if it is dropped.
● REMEMBER	Install CF300-E based on following environments. Adverse environments cause product deterioration and breakdown. Humidity: 35~65%RH (No dewing) Temperature: 0~40°C
⊘ PROHIBITED	Do not use CF300-E based on following environments. Adverse environments can result in explosion, fire, electric shock and accident. *Where explosion-proofing is required. *Where flammable atmospheres found. *Where temperature and humidity are outside specified ranges. *Where dewing or sharp temperature fluctuations occurs. *Where there is heavy dust or smoke. *Where possibly wet by water, oil, chemicals, etc. *Where strong electric or magnetic fields are generated.

1. When Used on a Desktop

CF300-E can be used on the desktop.

Do not locate on unstable tables, etc. CF300-E can be damaged and malfunctioned if it falls.

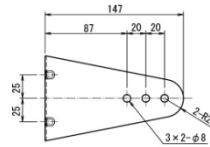

2. When Mounted on a Wall or Structure

- Select a location and height in consideration of CF300-E's static electricity removal range.
(For information regarding the static electricity removal range, refer to the section Performance.)
- Use the mounting holes in the bottom of the stand to secure it to the structure or cell base.
(For the dimension drawing, refer to the section Exterior view.)
- The angle can be adjusted using the angle adjusting knob located on the left and right sides of the stand.
Securely tighten these knobs after confirming the angle.
- Do not install this unit in dusty, hot or humid places or where possibly wet by water and oil.
- Keep objects from getting in-between CF300-E and the target area.
- Before installing CF300-E, check the strength of supporting structure.

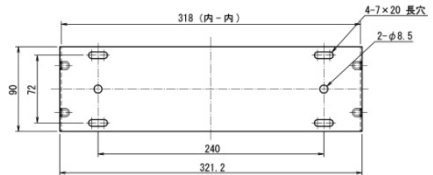

■ Before Use

⚠ CAUTIONS IN BEFORE USE

●	REMEMBER	Use only the included power supply adapter. Use of other adapters may result in fire, electric shock and static electricity removal trouble.
●	REMEMBER	If noticing anything strange, stop using CF300-E immediately.
●	REMEMBER	Be sure to connect the grounding wire. A failure may result if this unit is not properly grounded.
⊘	PROHIBITED	Do not use CF300-E other than static electricity removal.
⊘	PROHIBITED	Do not remodel or disassemble CF300-E. CF300-E contains high voltage parts.
⊘	PROHIBITED	Do not drop CF300-E or apply strong impacts.
⊘	PROHIBITED	Keep CF300-E away from sources of heat.
⊘	PROHIBITED	Do not test the electrode wires for grounding, short-circuiting or sparking. These tests can adversely affect ion balance.

■ Before Use

Connector connection

Insert the included special AC adapter connector into the jack on the back of the body.

Power Supply Adapter

Use the power adapter (AD24-ITE) which is specifically designed for use of CF300-E.

The AC adapter plug is a 2-pronged plug.

Connect this to a power outlet that has a ground terminal.

Connection of grounding wire

Plug this unit into a power receptacle which has a ground terminal.

If no such power receptacles are available, ground the unit with a wire connected to the ground terminal of the unit.

Daily Checks

Check CF300-E for inspection before use. Refer "Maintenance" pages.

- Dust on electrodes
- Contamination of the front cover
- Dirty filter
- Disconnection of the grounding wire
- Loose connector
- Damaged or loose parts
- Adhering condensation or water droplets

If damage or trouble is detected, contact the supplier for servicing.

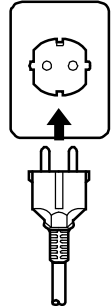

■ Names and Functions

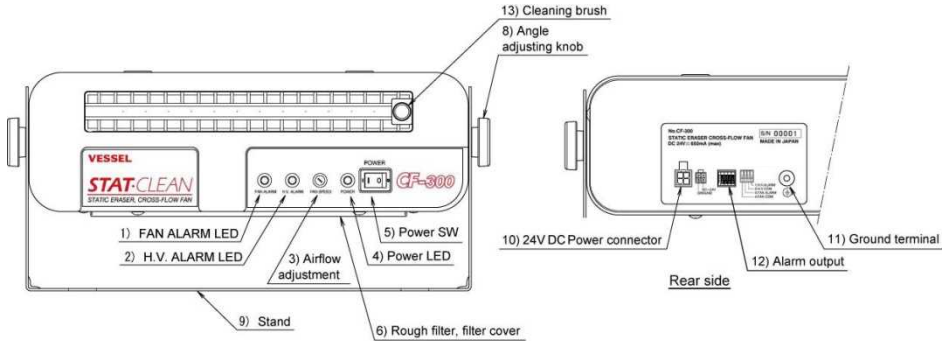

- | | |
|--|--|
| 1) Fan malfunction LED | : The FAN ALARM LED illuminates if the fan stops and fan lock is detected. |
| 2) High pressure abnormality warning LED | : The H.V. ALARM LED illuminates if the high pressure output stops. |
| 3) Airflow adjustment | : Used for adjusting the airflow of the fan. The airflow can be adjusted continuously. |
| 4) Power LED | : Check that the power is turned ON/OFF. |
| 5) Power switch | : Used for turning the power ON/OFF. |
| 6) Rough filter, filter cover | : A filter to prevent dust suction. |
| 7) Stand adjusting hole | : Used for adjusting the height of the body. |
| 8) Angle adjusting knob | : Used for adjusting the angle of the body. |
| 9) Stand | : Used for installing the body on a table or a structure. |
| 10) Power connector | : A connector for input power of 24 V DC. |
| 11) Ground terminal | : A terminal for grounding connection. |
| 12) Alarm output | : Used for external output of alarm signals. |
| 13) Cleaning brush | : Used to remove dust or dirt adhering to the needle electrode. |

■ Operation

1. CONNECTING THE AC ADAPTER

Power can be externally supplied to the unit without using the provided AC adapter.

Carry out wiring with a Molex connector as shown in the figure. Be sure to connect the ground connector. Otherwise, connect the ground terminal, which is located on the back side of the body, to the ground with a wire.

When stopping the unit, shut off the external power supply.

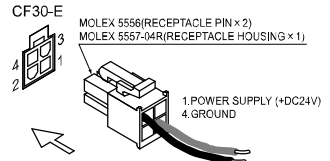

2. TURNING ON THE UNIT

Turn the power switch (POWER) to the [I] position.

The power light illuminates and the operation will start.

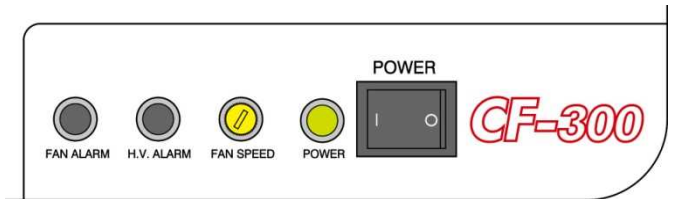

3. TURNING OFF THE UNIT

Turn the power switch (POWER) to the [O] position. The power light goes off and the operation will stop.

4. AIRFLOW ADJUSTMENT

The airflow can be adjusted continuously by turning the airflow adjustment (FAN SPEED) rotary control using a thin flat-tip screwdriver.

ALARM LED

1. H.V.ALARM

When the integrated piezoelectric transformer detects overload and shuts down the output, "HV ALARM" LED on the front face lights up and the operation is stopped.

If the alarm lights up, immediately disconnect the connector to shut off the electric power.

If a foreign matter adheres on the discharge needle, clean the needle and turn on the power again to check that the alarm does not light on.

If the alarm lights up again when turning on the power, always ask the dealer for the inspection and repair to prevent accidents.

2. FAN ALARM

The "FAN ALARM" LED, which is located on the front face, illuminates in red if the built-in fan is locked and a malfunction is detected.

When the "FAN ALARM" LED illuminates, immediately press the power switch to the OFF position.

If a foreign object is caught in the fan, remove it and turn the power switch to the ON position again to see if the "FAN ALARM" LED does not illuminate.





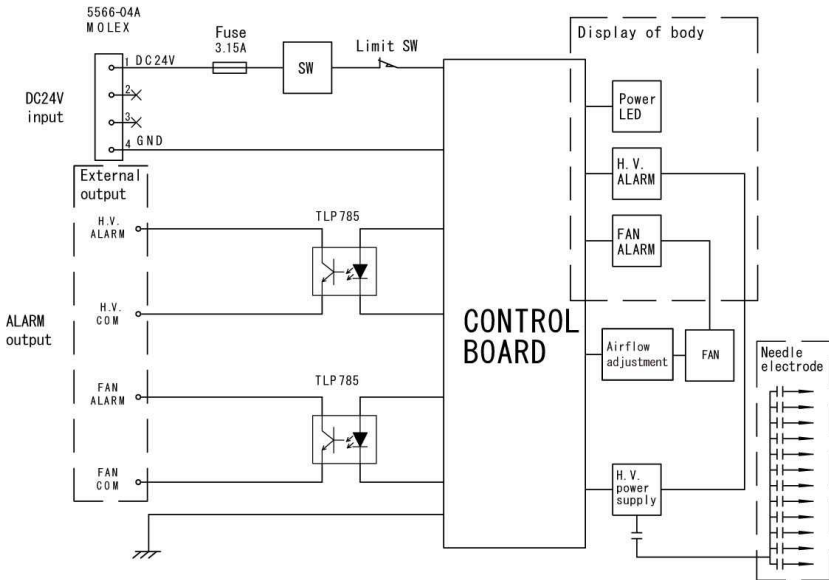

If the "FAN ALARM" LED illuminates again when the power is turned on, always have the unit inspected and repaired at the dealer to prevent an accident.

When alarm signal is output externally

With external output of alarm signal, warning devices such as lamps can be activated.



■ Maintenance

 CAUTIONS IN MAINTENANCE AND CHECKS	
 DO NOT DISASSEMBLE	Do not disassemble CF300-E. Servicing is reserved for service engineers.
 UNPLUG POWER CABLE	Before making checks, unplug the power cable. Working with the power on can result in electric shock and breakdown.
 PROHIBITED	Do not wipe CF300-E with detergent or solvent. It may cause cracking and result in electric shock or breakdown.
 DO NOT WET	Do not wet CF300-E. Contact with moisture can result in electric shock or breakdown.
 CHECK	Periodically check CF300-E. Failure of periodical inspection can result in early breakdown.

1. Casing Cleaning

To clean the casing, wipe with a dry soft cloth. Suck up dust from opening sections with a vacuum cleaner.

Do not wipe it with solvents such as thinner, or detergent.

2. CLEANING THE NEEDLE ELECTRODE

When the unit is used for a long period of time, dust or dirt adheres to the needle electrode, which causes the deterioration of antistatic performance or dust/dirt dispersion. Brush the needle electrode before using the unit.

Cleaning procedure

- 1) Turn the power switch to the OFF position to stop the operation.
- 2) Slide the brush installed on the unit to both ends to clean the needle electrode.

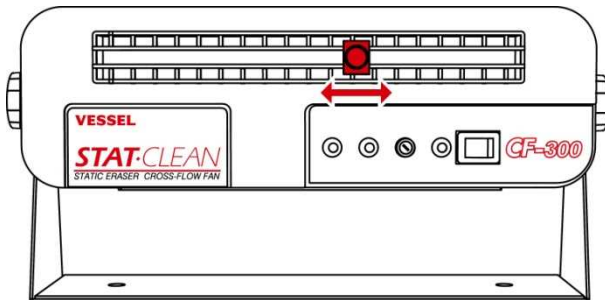

3. REPAIRING OR REPLACING THE NEEDLE ELECTRODE

If the cleaning brush becomes extremely dirty or the needle electrode is damaged, broken or bent, the components must be replaced. For repair and replacement of the parts, contact the dealer where the product was purchased.

⚠ CAUTION	
● CLEANING	If the electrode needles or front cover is dirty, it could lower the static erasing performance or cause dust to fly around. Be sure to clean the contaminated parts according to your service condition.
⚠ WARNING	
⊘ PROHIBITED	If HV ask us to have it replace the electrode needle unit is broken or dropped out, stop the operation and replace it with a new one. It can lead to an electric shock or injury.

■ Maintenance

4. Filter cleaning/replacement

Contamination degree of the filter depends on installation place and usage conditions.

If static erasing function or airflow decreases, clean the filter first.

During the filter cleaning, stop the operation, pull out the AC adapter plug from the receptacle or the AC adapter connector from the body.

Spread a cloth or the like on the table to protect the body or the devices from the damage.

Cleaning procedure

1. Remove the filter cover.
2. Remove the filter.
3. Rinse the filter with running water.
4. After the rinse, drain excess water and dry the filter thoroughly before the installation.

*If filter contamination cannot be removed or damage is serious, replace the filter.

(Use the optional filter CF-300F.)

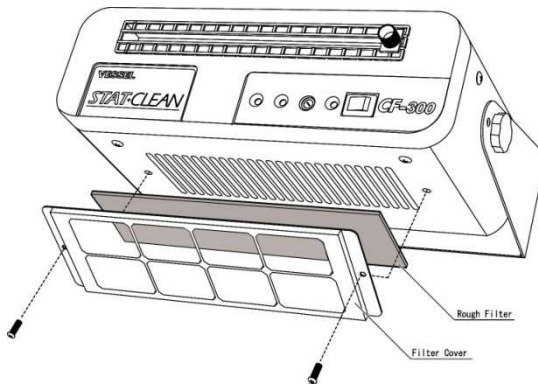





Accessories

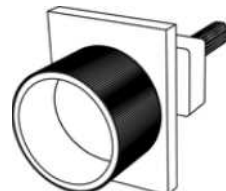
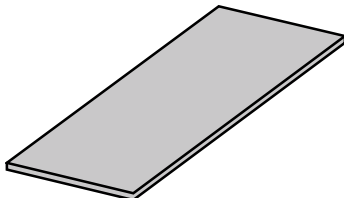

Rough filter : CF-300F

Cleaning brush : CF-300B



 CAUTION TROUBLESHOOTING	
 PROHIBITED	<p>Do not use CF300-E in the following situations. It may result in fire or electric shock.</p> <ul style="list-style-type: none"> * When CF300-E has been damaged because of dropping or shock * When air is not blowing though the power switch of the eraser is in the ON position * When the power cable is damaged or hot * When the power supply adapter is loosely connected to the electrical outlet
 UNPLUG POWER CABLE	<p>If trouble occurs with CF300-E, turn the power switch OFF and unplug the power cable.</p>
 DO NOT DISASSEMBLE	<p>Do not disassemble CF300-E.</p>

Do not continue using the unit in improper or abnormal condition, or otherwise a product damage or accident may result. If trouble occurs, promptly request servicing from your dealer.

 CAUTION STORAGE	
 PROHIBITED	<p>Do not store CF300-E in the following places. Adverse environments can cause product breakdown.</p> <ul style="list-style-type: none"> * Where exposed to vibrations or shock * Where temperature and humidity are outside specified ranges * Where dewing occurs * Where temperature fluctuates sharply * Where there is the possibility of ignition or explosion of flammable solvents, dust, etc. * Where there is heavy dust or smoke * Where possibly wet by water, oil, chemicals, etc. * Where strong electric or magnetic fields are generated

In the following cases, contact the supplier for servicing.

Do not service CF300-E yourself as this can be dangerous.

- * If the power lamp does not light when the power switch is in the ON position.
- * If the fan does not work.
- * If the machine is on during use and air sometimes blows, and other time doesn't blow.
- * If the power cable is excessively hot.
- * If the power supply adapter is excessively hot.
- * If CF300-E emits strange noises or vibrates during use.
- * If sparks are seen coming from electrode needle tips (In normal operation, sparks are not seen.)

LIMITED WARRANTY:

VESSEL expressly warrants that for a period of one (1) year from the date of purchase, VESSEL static erasers will be free of defects in material (parts) and workmanship (labour). Within the warranty period, Defects occurring will be repaired or products will be replaced at VESSEL's option and expense, if VESSEL receives notice during the warranty period. Defective products must be returned to VESSEL Osaka Japan with proof of purchase date. And if your unit is out of warranty, VESSEL will quote repair charges necessary to ship your unit freight prepaid to where you have originally purchased.

WARRANTY EXCLUSIONS:

THE FOREGOING EXPRESS WARRANTY IS MADE IN LIEU OF ALL OTHER PRODUCT WARRANTIES, EXPRESSED AND IMPLIED, INCLUDING FITNESS AND MERCHANTABILITY AND FITNESS FOR A PARTICULAR PURPOSE WHICH ARE SPECIFICALLY DISCLAIMED.

The express warranty will not apply to defects or damage due to accidents, neglect, misuse, alterations, operator error, or failure to properly maintain, clean, or repair products.

LIMIT OF LIABILITY:

This electronic static eraser use high voltage corona discharge and should not be used in or near flammable or explosive environments. In no event will VESSEL or any seller is responsible or liable for any injury, loss or damage, direct or consequential, whether based in tort or contract arising out of the use of or the inability to use the product. Fulfillment of VESSEL's warranty obligations will be Customer's exclusive remedy and VESSEL's and Seller's limit of liability for any breach of warranty or otherwise. Before using this unit, users shall determine the suitability of the product for their intended use, and users assume all risk and liability whatsoever in connection therewith.

Model	CF300-E	
Warranty	(1) year from the date of purchase	
Customer	Name	
	Address	
	Tel. No.	
Dealer	Name/Address/Tel. No.	

VESSEL Co., Inc.

17-25, Fukae-Kita 2-chome,
Higashinari-ku, Osaka 537-0001 Japan
Tel : +81 6 6976 7778 Fax : +81 6 6972 9441
E-mail : export@vessel.co.jp
URL : www.vessel.co.jp