

VESSEL

Let us think

Instruction Manual

No. F-120R-E

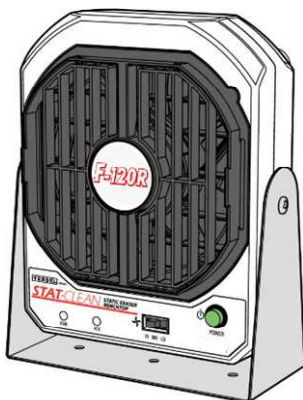

STAT-CLEAN F120R-E

STATIC ERASER BENCHTOP

Thank you for purchasing our Stat Clean No. F120R-E.
Read this instruction manual before use. Keep it in a safe handy place for future reference.

Table of Contents

■ For Your Safety	P.14
■ Product Features	P.15
■ Production Specifications	P.15
■ External View	P.16
■ Performance	P.17
■ Installation	P.17
■ Before Use	P.18
■ Operation	P.19
■ Maintenance	P.21
■ Troubleshooting	P.23
■ Storage	P.23
■ Warranty	P.24

■ For Your Safety

Safety Precautions

● Carefully read these Safety Precautions before use. Observe the precautions indicated herein to ensure safety.

● Safety precautions in this instruction manual are categorized into two types by the degree of danger associated with each of the followings. Based on danger analyses performed by Vessel, all precautions in this instruction manual are of the CAUTION level.

● If the equipment is used in a manner not specified by the manufacturer, the protection provided by the equipment may be impaired.

△ **WARNING** Indicates that improper handling can lead to serious injury or even death.

△ **CAUTION** Indicates that improper handling can lead to minor injury and property damage.

△ This symbol indicates a WARNING or CAUTION.

⊘ This symbol indicates a prohibited action.

● This symbol indicates a mandatory required action

△ CAUTIONS

⊘ PROHIBITED Do not use the F120R-E in environments that require explosion-proofing. The F120R-E is not of explosion-proof construction; therefore explosion or fire may occur.

⊘ PROHIBITED Do not use the F120R-E in flammable atmospheres. The corona discharge can act as an ignition source and cause an explosion or fire.

⊘ PROHIBITED Do not use the F120R-E in environments subjected to sharp temperature fluctuations or dewing. This kind of environment can lead to breakdown.

⊘ DO NOT WET Do not use the F120R-E in highly damp places or anywhere it may be wet by water, oil, solvent or other liquid. Contact with moisture can result in electric shock or breakdown.

⊘ PROHIBITED Do not use the F120R-E for any other purpose than static erasing or dust removal.

⊘ PROHIBITED Do not use the F120R-E with power supplies of ratings not specified in the specifications. Inappropriate power supplies can result in fire and electric shock.

⊘ PROHIBITED Do not install, use or service the F120R-E until having understood the information in this instruction manual.

● REMEMBER Keep this instruction manual in a safe handy place for future reference.

△ CAUTION VESSEL assumes no responsibility whatsoever for consequences arising from the use of this product.

■ Product Features

■ AC type corona discharge

- This is an AC corona discharge type ionizer. The ion balance is not disturbed by needle contamination.
- A high-frequency piezoelectric transformer is incorporated. Losses caused by recombination of ions are reduced, and ions are generated efficiently.

■ Fan type ionizer

- The powerful 120 mm square DC fan feeds ionized air to remote places.
- The fan's airflow volume can be adjusted in three steps.
- The airflow direction can be changed vertically by adjusting the stand's screw.
- Components are assembled into the compact body to create a small and lightweight product.
- The input power is 24 VDC. Power is supplied to the product from the enclosed dedicated AC adaptor.

■ Capacitive-coupled discharge

- The capacitive-coupled method applies a high voltage onto the discharge needle, thus providing outstanding ion balance stability.

■ Product Features

■ Variable louver function

- The airflow direction angle on the front cover can be changed to straight or wide to set the static erasing range.

■ Safe design

- When the front cover is removed, the circuit is shut off and the power is turned OFF to prevent electric shocks.
- Fan -lock alarm function and high voltage output stop alarm function are available as a standard. The status is indicated with LED lamps.
- The alarm signals can be output externally to operate an external device such as lights.
- The high-frequency piezoelectric transformer has an output shutdown function which instantly lowers the output in the event of a short circuit or overload.

■ Maintenance

- The front cover can be opened and closed with a single touch. Easy access to the internal components simplifies maintenance.
- The “needle electrode”, which must be cleaned or replaced, is unit-type module which can be replaced easily without tools.

Applications

Use to prevent trouble and dust adhesion caused by static electricity.

■ Product Specifications

Ionizer

Product Number	: № F120R-E (Model: F-120)
Ion generation method	: High voltage AC corona discharge
Output voltage	: AC 10 kV (p-p)
Input voltage	: DC 24 V ±5% 700 mA(max)
Dimensions	: H198 × W162 × D69.5 mm (including stand)
Weight	: 0.9 kg
Fan speed	: 3.66 m ³ / min (Max. fan speed)
Blow speed	: 5.0 m/s (HI), 4.4 m/s (MD), 3.9 m/s (LO)
Noise emission	: 61 dBA (max. and straight airflow, without filter, measured at 1m) (actual measured value)
Ozone generation	: 0.05 ppm or less (Measured at 50mm)
Warning output	: High voltage alarm (Red LED), stop due to fan lock (Red LED)
Protective function	: Fan motor rotation monitoring function (Detecting rotation lock) : High-voltage output shut down function (overload detection) : Front cover safety device (circuit cut off when open)
Working temperature / humidity	: 5 ~ 40 °C / 35 ~ 65 %RH (No dewing)
Storage temperature / humidity	: 0 ~ 60 °C / 35 ~ 85 %RH (No dewing)
Distance from target area	: 150 ~ 900 mm (Installation location: Non-hazardous indoor location)
Static electricity removal time	: Refer to the items in the capabilities chart.
Ion balance	: Within ±10 V (max. and straight airflow, without filter) (at the time of shipment from the manufacture's warehouse)
Material	Casing: Flame-retardant ABS, Stand: Stainless Front Cover: Flame-retardant ABS, Electrode: Inconel

■ Product Specifications

Accessories

· Adapter No.AD24-IT-EX

Rated input voltage : AC 100 V – 240 V (50 / 60Hz) 0.4A

Rated output voltage : DC 24V 0.75A

Working temperature /humidity : 0 ~ 40 °C / 10~85 %RH (No dewing or freezing)

Cable length : DC output cable: approx. 1.8 m, AC input cable: approx. 1.8 m

Weight : 135 g

Consumables

Electrode Needle Unit : F-120RCH

*The measurement values were obtained using the VESSEL measurement environment, so errors could be induced depending on the operation environment.

■ External View

No F120R-E

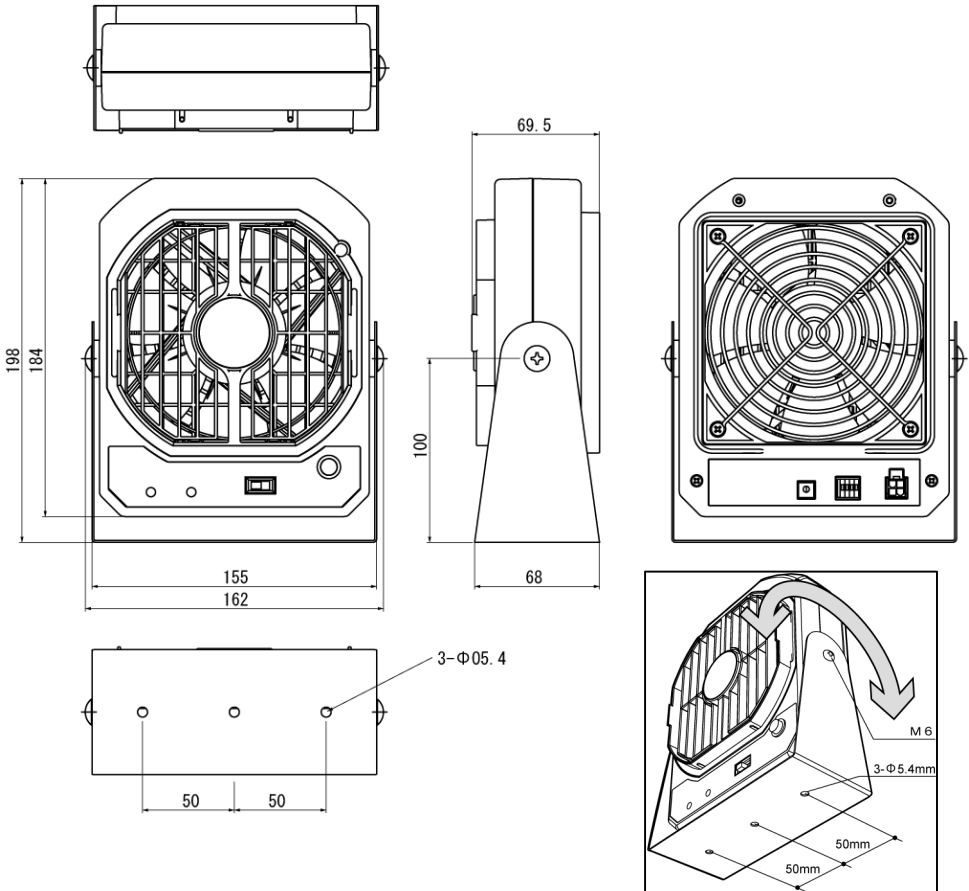

External View

No.AD-24-IT-EX

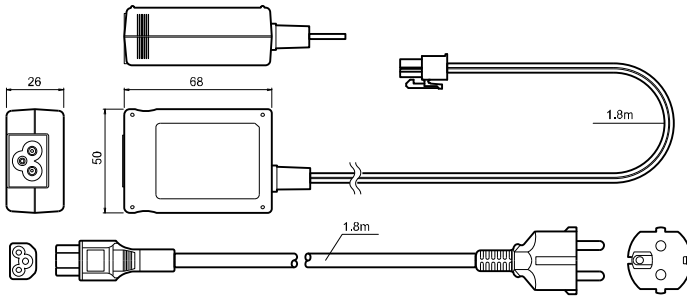

Performance

Static elimination efficiency

Based on IEC61340-4-7 compliant CPM : TREK 158, Temperature:25°C, Humidity:50%

■ Straight airflow at HI fan speed

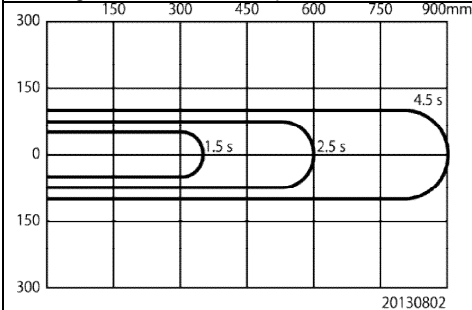

■ Wide-angle airflow at HI fan speed

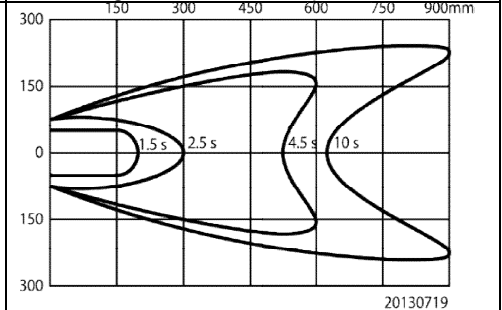

The above values were based on tests with a sample unit.

They represent the central tendency of this model, but they are not guaranteed.

Installation

⚠ CAUTIONS

● REMEMBER	Use only the included power supply adapter. Using other adapters may result in fire, electric shock and static electricity removal troubles.
● REMEMBER	Install the F120R-E securely. The F120R-E can be damaged or malfunction if it is dropped.
● REMEMBER	Install the F120R-E based on environments stated below. Adverse environments cause product deterioration and breakdown. Humidity: 35~65%RH (No dewing) Temperature: 5~40°C

■ Installation

⚠ CAUTIONS (cont.)

<p>⊘ PROHIBITED</p>	<p>Do not use the F120R-E based on environments stated below. Adverse environments can result in explosion, fire, electric shock and accident.</p> <ul style="list-style-type: none"> *Where explosion-proofing is required; *Where flammable atmospheres are found; *Where a significant vibration and/or impact is given; *Where temperature and humidity exceed specified ranges; *Where dewing or sharp temperature fluctuations occurs; *Where there is heavy dust or smoke; *Where water, oil, chemicals, etc are used; *Where strong electric or magnetic fields are generated.
---------------------	--

When Used on a Desktop

The F120R-E can be used on the desktop.

Do not locate on unstable tables, etc. the F120R-E can be damaged and/or malfunction if it is dropped.

When Mounted on a Wall or a Structure

- Select a location and height in consideration of F120R-E's static electricity removal range. For information regarding the static electricity removal range, refer to Static Electricity Removal Performance.
- Use the mounting holes in the bottom of the stand to secure it to the structure or cell base. For the dimension drawing, refer to External View.
- The angle can be adjusted using the adjustment screws located on the left and right sides of the stand (Phillips screw M6).
Securely tighten the adjustment screws after adjustment.
- Keep objects from getting in between the F120R-E and the target area.
- Before installing the F120R-E, check the strength of supporting structure.
- Please keep backside of the F120R-E away from the object and keep away from the wall surface at least 100mm for the proper function of the fan.

■ Before Use

⚠ CAUTIONS

● REMEMBER	Use only the included power supply adapter. Use of other adapters may results in fire, electric shock and static electricity removal trouble.
● REMEMBER	If noticing anything strange, stop using the F120R-E immediately.
⊘ PROHIBITED	Do not use the F120R-E for other purpose than static electricity removal.
⊘ PROHIBITED	Do not remodel or disassemble the F120R-E. The F120R-E contains high voltage parts.
⊘ PROHIBITED	Do not drop the F120R-E or apply strong impacts.
⊘ PROHIBITED	Keep the F120R-E away from sources of heat.
⊘ PROHIBITED	Do not test the electrode needles for grounding, short-circuiting or sparking. These tests can adversely affect ion balance.

Connector connection

Insert the included dedicated AC adapter connector into the jack on the back of the body.

- Connector specification (power supply)

Item	Mfr.	Model №	Qty.
Housing	MOLEX	39-01-2040 (old"5557-04R")	1
Receptacles	MOLEX	39-00-0212 (old"5556-S3PL")	2

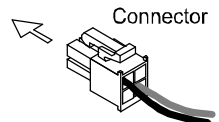

■ Before Use

Connector connection (cont.)

- Pin assign
From wiring side: 4 – GND, 1 - +24V



Power Supply Adapter

Use the power adapter (AD24-IT) which is specifically designed for use of the F120R-E.
The AC adapter plug is a 3-pronged plug.
Connect this to a power outlet that has a ground terminal.

Daily Checks

Check the F120R-E for inspection before use.

- Dust on electrodes
- Loosened connector
- Damaged or loosened parts
- Adhering condensation or water droplets

If damage or trouble is detected, contact the supplier for servicing to avoid accidents.

■ Operation

Power

Power is turned on by pressing the Power switch.
H.V. lamp and fan lamp light up in green, and then the unit start the operation.
When you press the power switch again, power is turned off.

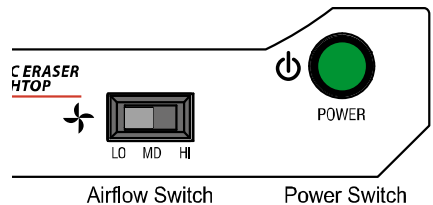

Fan speed

The fan's airflow volume can be adjusted in three steps [LO - MD - HI].
Please adjust the air with the Airflow switch.

Variable louver

The airflow direction angle at the front cover can be changed to set the static erasing range.

- Straight

This is useful when the charged object is relatively far or when you need to eliminate static electricity at high speed.

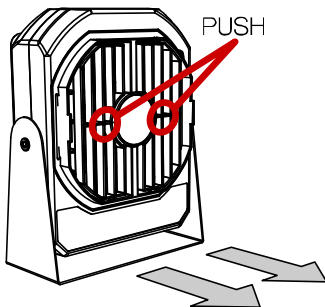

- Wide angle

This is useful when you need to eliminate static electricity in wide range.

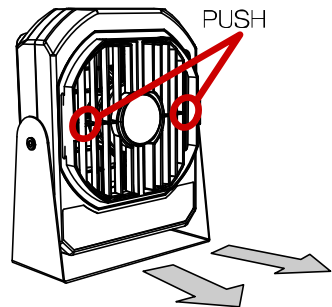

■ Operation

ALARM LAMPS

● H.V. Alarm (High voltage alarm lamp)

The lamp lights in green when the high voltage transformer emits properly the high voltage. If the piezoelectric transformer detects an overload and shuts down the operation, the high-voltage alarm lamp will light up in red.

When the H.V. lamp lights in red,

1) Immediately unplug the power cable or pull out the wires from terminals.

2) Remove the fan cover and visually inspect around the electrode needles. If foreign particles are adhered to the needles, refer to Cleaning Procedure and clean the needles.

● Fan Alarm (Fan lock alarm lamp)

The lamp lights in green when the fan operates properly.

Fan lock alarm lamp lights in red when the fan motor stops rotating.

When fan lock alarm lamp lights in red,

1) Unplug the power cable or pull out the wires from terminals.

2) Remove the fan cover and visually inspect the fan.

If foreign particles or objects are adhered to the fan, remove them, switch on the power again and make sure that the lamp is off.

*If the alarm lamp light in red again even though the causes are resolved, contact the supplier for servicing to avoid accidents.

* Immediately after turning on the power, there is a moment that the fan lamp glows red.

This is not a malfunction.

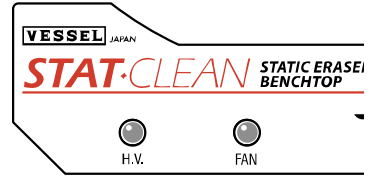

H.V. Alarm Fan Alarm

When externally outputting the alarm signal

The lights and other external alarm devices can be operated by alarm signal output.

Abnormal High Voltage alarm output:

Connecting a load to the input/output terminal # 1 and # 2

Fan Lock alarm output:

Connecting a load to the input/output terminal # 3 and # 4

1 2 3 4



Circuit diagram

① Abnormal High Voltage alarm output

② Abnormal High Voltage alarm output GND

③ Fan Lock alarm output

④ Fan Lock alarm output GND

※ Photo coupler: SHARP PC817

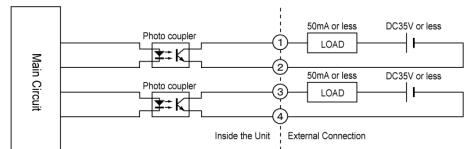

Filter (Option)

Fan filter is available, depending on the applications.

1) Loosen with a Philips screwdriver the screws (4 pcs.) which fix the fan on the backside.

2) Replace metal Finger Guard with a resin Finger Guard of Filter set, and fix the resin Finger Guard with screws.

3) Mount filter with a filter cover.

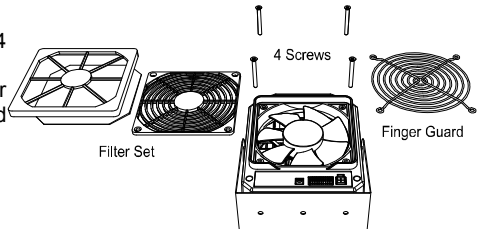

■ Maintenance

Filter (Option) (cont.)

⚠ CAUTIONS

⊘ DO NOT DISASSEMBLE	Do not disassemble the F120R-E. Servicing is reserved for service engineers. Electric shock, malfunction, or injury may occur.
● UNPLUG POWER CABLE	Before making checks, unplug the power cable. Working with the power on can result in electric shock and breakdown.
⊘ PROHIBITED	Do not wipe the F120R-E with detergent or solvent. It may cause cracking and result in electric shock or breakdown.
⊘ DO NOT WET	Do not wet the F120R-E. Contact with moisture can result in electric shock or breakdown.
● CHECK	Periodically check the F120R-E. Failure of periodical inspection can result in early breakdown.

Casing Cleaning

To clean the casing, wipe with a dry soft cloth. Suck up dust from openings with a vacuum cleaner.

⚠ CAUTIONS

⊘ PROHIBITED	Do not wipe it with solvents or cleaners, such as alcohol or paint thinner. It may cause cracking and result in electric shock or breakdown.
⊘ DO NOT WET	Do not wet the F120R-E. Contact with moisture can result in electric shock or breakdown.

When cleaning the front cover

After using for long hours, dust adhered to the front cover may lower the ionizing performance or cause dust to fly around.

Care for periodical cleaning.

- 1) Be sure to turn the power switch off to stop the operation.
- 2) Unplug the power supply adapter from the electrical outlet.
- 3) Remove the screw that secures the front cover.
- 4) Removing the front cover.
- 5) Wipe it with a dry, soft cloth.
Be careful not to stick yourself on the needles.
- 6) Reinstall the front cover.

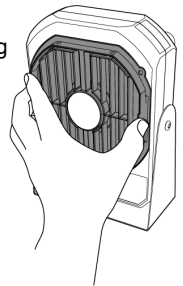

When cleaning the front cover

⚠ CAUTION

● CLEANING	A dirty front cover could lower the static erasing performance or cause dust to fly around. Be sure to clean it as required by the operation environment.
------------	---

Electrode Needle Cleaning/Replacement

After using long hours, dust adhered around the electrode needles. Dust adhesion can lower the ionizing performance. Be sure to periodically clean or replace the electrode needles.

The recommended replacement interval is 100 hours of operation (This is just reference).

- 1) Remove the front cover in procedure set forth in the preceding paragraph.
- 2) Clean the electrode needles with a cotton swab or a brush.
Please wipe off the dust of the needle tips.

If the tips are very dirty, please remove the adhered particles with a cotton swab moistened with alcohol.

Be careful not to stick yourself on the needles.

- 3) Attach the front cover to the F120R-E and connect the AC adapter.

Make sure the front cover is securely installed. If the cover is not installed correctly, the safety mechanism will operate causing the fan to stop.

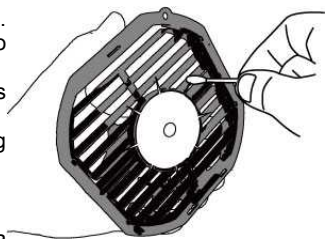

■ Maintenance

Electrode Needle Cleaning/Replacement (cont.)

⚠ CAUTION

● CLEANING

If the discharge needle is dirty, it could lower the static erasing performance or cause dust to fly around. Be sure to clean the contaminated parts according to your service condition.

When replacing the Electrode Needles

If the static erasing performance does not recover even after cleaning the electrode needles, they may be worn out.

Remove the front cover in the same way as for cleaning and replace it with a new one.

Be careful not to stick yourself on the needles.

⚠ WARNING

⊘ PROHIBITED

If the electrode needles is broken or worn out, stop the operation and replace it with a new one. It can lead to an electric shock or injury.

When cleaning the filter (Option)

After being used for a long time with a filter available as option, dust adhered to the filter could lower ionizing performance or cause dust to fly around. Be sure to periodically clean or replace the filter.

- 1) Before cleaning the filter, stop operation of the F120R-E, turn off power.
- 2) Unplug the AC adapter or pull out the wires from input/output terminals.
- 3) Take out the filter cover.
- 4) Remove and clean the filter. Make sure the filter is completely dry before reuse. Installing the filter while still wet may damage the F120R-E.
- 5) Wipe off the dust adhered on the filter cover with a cloth. Dust may also be on the outside and/or inside the filter cover, so use a dry and soft cloth to wipe dust off.
- 6) Mount again the filter and the filter cover.

⚠ CAUTION

● CLEANING

If the filter is dirty, it could lower the static erasing performance or cause dust to fly around. Be sure to clean the contaminated parts according to your service condition.

When replacing the filter

In the case that the dust cannot be removed even after cleaning, replace it with a new one.

Remove the filter cover with the same procedure as for cleaning and then replace the filter with a new one.

Consumables

Front cover with
Electrode needles
F120R-E

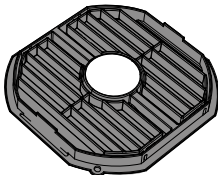

Filter set: F-120FS

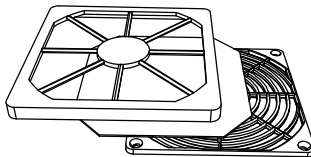

Filter: L-90F

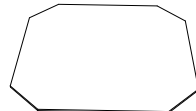

■ Troubleshooting

Using the F120R-E in anything but proper working condition can cause damages on the product or accidents/injuries on the personnel.

Therefore, promptly request servicing if trouble occurs. For servicing, contact us or our distributors.

⚠ CAUTIONS	
⊘ PROHIBITED	<p>Do not use the F120R-E in the following situations. It may result in fire or electric shock.</p> <ul style="list-style-type: none"> * When the F120R-E has been damaged because of dropping or shock * When air is not blowing though the power switch of the eraser is in the ON position * When the power cable is damaged or hot * When the power supply adapter is loosely connected to the electrical outlet. * When the F120R-E is damaged because of dropping, shock or other causes.
● UNPLUG POWER CABLE	<p>If trouble occurs with the F120R-E, turn the power switch OFF and unplug the power cable.</p>
⊘ DO NOT DISASSEMBLE	<p>Do not disassemble the F120R-E.</p>

■ Storage

In the following cases, contact the supplier for servicing.

Do not service the F120R-E by yourself to avoid accidents.

* The power lamp does not light when the power switch is in the ON position

* Air is not blown when the airflow switch is turned

* When the F120R-E is moved during operation, sometimes airflow comes out or sometimes not

* The power cable is excessively hot

* The power supply adapter is excessively hot

* If the F120R-E emits strange noises or vibrates during operation

* If sparks are seen coming from electrode needle tips (In normal operation, sparks are not seen).

⚠ CAUTION	
⊘ PROHIBITED	<p>Do not store the F120R-E in the following places. Adverse environments can cause product breakdown.</p> <ul style="list-style-type: none"> * Where exposed to vibrations or shock * Where temperature and humidity are exceeding specified ranges * Where dewing occurs * Where temperature fluctuates sharply * Where there is the possibility of ignition or explosion of flammable solvents, dust, etc. * Where there is heavy dust, particles or smoke * Where possibly wet by water, oil, chemicals, etc. * Where strong electric or magnetic fields are generated

LIMITED WARRANTY:

VESSEL expressly warrants that for a period of one (1) year from the date of purchase, VESSEL static erasers will be free of defects in material (parts) and workmanship (labour). Within the warranty period, Defects occurring will be repaired or products will be replaced at VESSEL's option and expense, if VESSEL receives notice during the warranty period. Defective products must be returned to VESSEL Osaka Japan with proof of purchase date. And if your unit is out of warranty, VESSEL will quote repair charges necessary to ship your unit freight prepaid to where you have originally purchased.

WARRANTY EXCLUSIONS:

THE FOREGOING EXPRESS WARRANTY IS MADE IN LIEU OF ALL OTHER PRODUCT WARRANTIES, EXPRESSED AND IMPLIED, INCLUDING FITNESS AND MERCHANTABILITY AND FITNESS FOR A PARTICULAR PURPOSE WHICH ARE SPECIFICALLY DISCLAIMED.

The express warranty will not apply to defects or damage due to accidents, neglect, misuse, alterations, operator error, or failure to properly maintain, clean, or repair products.

LIMIT OF LIABILITY:

This electronic static eraser use high voltage corona discharge and should not be used in or near flammable or explosive environments. In no event will VESSEL or any seller is responsible or liable for any injury, loss or damage, direct or consequential, whether based in tort or contract arising out of the use of or the inability to use the product. Fulfillment of VESSEL's warranty obligations will be Customer's exclusive remedy and VESSEL's and Seller's limit of liability for any breach of warranty or otherwise. Before using this unit, users shall determine the suitability of the product for their intended use, and users assume all risk and liability whatsoever in connection therewith.

Model	F120R-E	
Warranty	(1) year from the date of purchase	
Customer	Name	
	Address	
	Tel. No.	
Dealer	Name/Address/Tel. No.	

VESSEL Co., Inc.

17-25, Fukae-Kita 2-chome,
Higashinari-ku, Osaka 537-0001 Japan
Tel : +81 6 6976 7778 Fax : +81 6 6972 9441
E-mail : export@vessel.co.jp
URL : www.vessel.jp

Ver.3 Printed on 2019.10.15