



# PORTABLE REFRIGERATOR OWNERS HANDBOOK

FOR MODELS MANUFACTURED FROM JULY 2020



**LEGACY Single Compartment Models:** NL40/52/55/65/80/125

**LEGACY Dual Control Models:** NL50/60/72/90/110





# PORTABLE REFRIGERATION

The National Luna Range of products has been designed and manufactured in South Africa since 1989.

Every product sold is of the highest possible quality, manufactured with world-class technology, marketed and serviced by a knowledgeable and dedicated team both Locally and Internationally.

## National Luna Portable Refrigeration Models:

**National Luna Single Compartment Models:** NL40/52/55/65/80/125

**National Luna Dual Control Models:** NL50/60/72/90/110

This Manual is a combined publication,  
for National Luna **LEGACY** models manufactured from  
July 2020 & contains relevant information, common to all Models.

Please register your warranty online:  
**[www.nationalluna.com.au](http://www.nationalluna.com.au)**

(See page 31 for details)

# Introduction

## Congratulations on the purchase of your National Luna LEGACY Portable Fridge / Freezer.

The National Luna range of portable fridges and freezers are high-performance, high efficiency refrigerators ideal for harsh conditions and applications that are limited to battery power such as off-road vehicles, caravans and solar installations.

The versatility of each of the National Luna models allows the use of a wide range of AC supply voltage (85Vac - 265Vac), as well as 12-volt (9.6-17.0Vdc) and/or 24-volt (17.5-31.5Vdc) battery power.

The use of a custom-designed digital thermostat and smart control circuitry ensures temperature stability and low power consumption.

All refrigerator models are built using high quality materials, unique assembly techniques and strict testing procedures to ensure the highest level of quality and performance.

### Precautions

When the refrigerator is used in an automotive application, ensure that it is secured to prevent accidental movement. The carry handles can be used with straps or tie-downs if necessary.

- A base mounting plate is optional and recommended for most applications.
- Ensure the correct type of cable and connectors are used for installation.
- Ensure that any power leads connected to the refrigerator will not be pulled or damaged by any movement of the fridge - especially where slides or drawers are used.
- Do not use a power lead that is damaged.
- Do not connect the refrigerator to a power source that does not comply with the input power specifications. (Displayed on the fridge's rear panel)
- When storing the fridge, ensure that the lid is propped open to allow for breathing. Disconnect the appliance from an electrical source. (Note: When the fridge is switched off, the interior light will still function if the unit is connected to a power source).
- Do not block or cover the ventilation holes. (During off-road conditions items may become lodged around the cooling area).

# Index

<b>Introduction</b>	3
---------------------	---

## **Getting to know your Portable Fridge**

• Securing your Fridge - Base Mounting Plate	6
• Securing your Fridge - Tie-down Straps	6
• Air Flow	6

## **Installation Guidelines**

• Electrical Connections	7
• Fitting an In-line Fuse	7
• Connecting Power	8
• Wiring Specifications	8

## **Battery voltage vs capacity**

• Low Voltage Battery Protection (cut-in/cut-out)	9
---	---

## **Operating your Fridge**

• Dynamics of Temperature Settings	10
• Thermostat Control	10
• Temperature Guidelines	10
• Celsius / Fahrenheit Conversion Chart	10

## **Operating your Single Compartment Fridge**

**(Models: NL40/52/55/65/80/125)**

• Getting to know your portable Fridge	11
• Main Control Panel	12
• On/Off Control	12
• Battery Protection Settings	12
• Smart Compressor Speed Control	13
• Speed Control Setting	13
• Setting the Temperature	14
• Indicator Lights	14

## **Operating your Dual Control Fridge**

**(Models: NL50/60/72/90/110)**

- Single Door (NL50/60/90) 15
- Double Door (NL72/110) 15
- Main Control Panel 16
- On/Off Control 16
- Battery Protection Settings 16
- Smart Compressor Speed Control 17
- Speed Control Setting 17
- Setting the Temperature 18
- Minimum Temperature Settings 18
- Indicator Lights 18

**Dual-Direction Lid (Models NL50 & NL52 only)** 19

## **Trouble Shooting**

- Indicator Lights 20
- Fault Description 20
- Trouble Shooting & Remedial Action 21

## **General Maintenance**

- Removal of Side Cover 22
- Removal of Electronic Compressor Driver 22
- Replacing the DC fuse 22
- Replacing the AC Power Supply 22
- Replacing the Temperature Probe 23
- Cleaning the Condenser / Replacing the Fan 23
- Removing & Replacing the Interior LED Light 23
- Door Seal & Adjustment (Loose latch condition) 24
- Removing & Replacing Multi-cavity Door Seal 24

**Care and Cleaning** 25

## **National Luna Warranty**

- South Africa Only - 3 Year Comprehensive 26
- Australian Warranty & Service Information 28
- Identifying the Firmware Installed in your Fridge 30
- Safety Precautions 32
- Disposing of your Old Appliance 32

# Getting to know your portable Fridge

## Securing your Fridge in a vehicle using a Base Mounting Plate

A low-profile design with locking pin, this base offers a fixed mounting position with an easy to remove mechanism. The optional base mounting plate allows the refrigerator to be securely fastened to the floor or body of the vehicle.

The unique locking design ensures that the Fridge remains fixed in position.

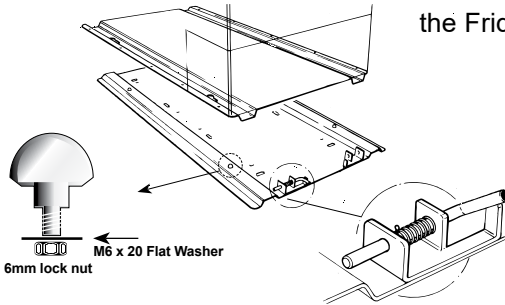

## Securing your Fridge in a vehicle using Tie-Down Straps



The sturdy and functional carry handle has a slot into which a hold down strap can be fitted as indicated.

(Care must be taken not to over-tighten the hold-down strap when using a ratchet device.)

## Air Flow

Allow a 100-200 mm gap around the refrigerator compressor area for ventilation (Airflow). The higher the ambient temperature, the more ventilation space is required for efficient airflow and cooling. (In the case of restricted airflow, the compressor will automatically shut down - see page 21 for Trouble Shooting).

Do not block or cover the ventilation holes. (During off-road conditions items may become lodged around the cooling area).



# Installation Guidelines

## Electrical Connections

When installing the refrigerator into a vehicle for the first time, ensure that the electrical connections to the vehicle's battery are secure and the specified wiring is used. (See wiring guidelines on page 8)

The fridge is supplied with a power lead for use with a 12 Volt DC supply.

This power lead is terminated with a high-quality male plug for connection into your vehicle.

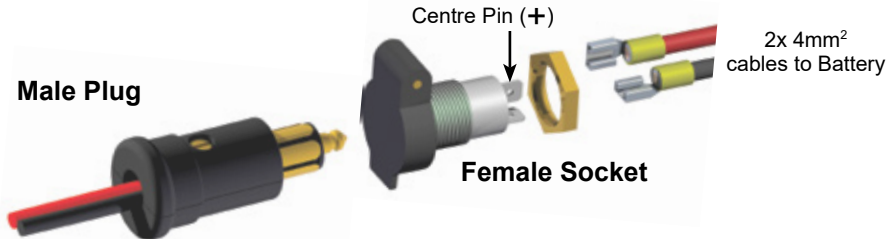

1. Install the supplied female socket into your vehicle in a convenient location.

2. Use suitable cables to connect the female socket to the vehicle's battery. (Cable thicknesses of 4mm<sup>2</sup> or greater is recommended.)



When installing electrical outlets in your vehicle, do not rely on the vehicle's body for an electrical earth path.

- If you choose to change the male plug on the DC cable supplied for a different type of plug, first ensure that all power has been disconnected.
- Split and strip the wires as required for the new plug. Take care to ensure that the correct polarity is used on the new plug and crimp the connections where possible.

## Fitting an in-line fuse

Although the fridge has a built-in fuse, it is recommended to install an additional fuse on the positive wire as close to the battery as possible. This will protect against short-circuits that may occur along the length of the cable.

Ensure that all connections are properly crimped and insulated.

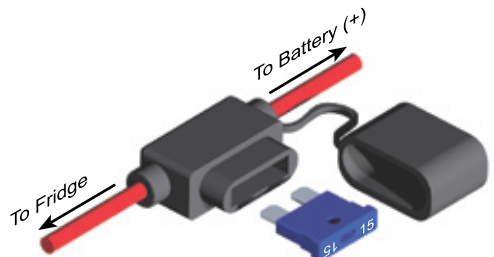

An automotive fuse with a rating of 15A is recommended

# Installation Guidelines

## Connecting Power

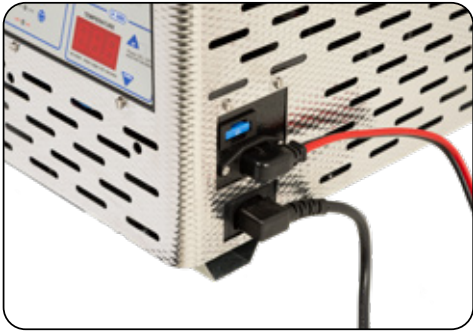

This Fridge can accept a DC voltage ranging from 9.6V to 31.5V, as well as an AC voltage range from 85V to 265V.

The 12Vdc power input is protected with a 15A automotive blade fuse.

An AC and DC source can be connected to the refrigerator simultaneously. Under these conditions, the AC supply will be chosen as the primary power source.

If the AC supply is interrupted, the DC supply will be automatically selected and operation will continue normally. (After a 1 minute delay)

## Suggested Wiring Specifications / Guidelines

One of the most problematic issues with installing a 12 Volt refrigeration system is incorrect wiring. Most users do not understand the importance of maintaining battery voltage over the distance from the battery to the installed Fridge. While most car cigarette lighter sockets appear to be adequate, in practise a large voltage drop occurs between the socket and the car battery. This may result in the fridge shutting down as a result of a low-voltage condition.

It is recommended the following table be used as a guide to establish what cable thickness is to be used depending on the distance from the car battery to the fridge. As a rule of thumb one should use a 1.0 mm<sup>2</sup> multi-strand copper wire per meter of distance from the battery. (minimum 4mm<sup>2</sup>)

Cable Size		Max Length between battery & fridge
AWG Approximate	Cross Section mm <sup>2</sup>	12 Volt Operation Meters
<b>11</b>	<b>4</b>	<b>4</b>
<b>9</b>	<b>6</b>	<b>6</b>
<b>7</b>	<b>10</b>	<b>10</b>
<b>5</b>	<b>16</b>	<b>16</b>

Note: Two wires (positive & negative) must be connected from the battery to the Fridge / plug point.



# Battery Voltage vs Capacity

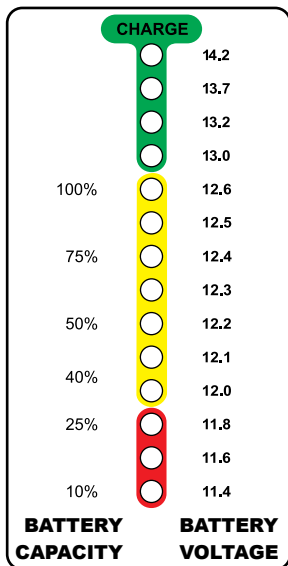

- Voltage of a battery can be an indication of its “state-of-charge”.
- The voltage-capacity relationship is most accurate when the fridge is not running and the battery temperature is at 25°C.
- By measuring the voltage, we can estimate the amount of energy remaining in the battery.
- Changes in temperature, battery age and general battery health can influence this relationship and therefore result in inaccurate capacity measurement.
- Normal battery operation takes place between 12.0 and 12.6 volts.
- Depending on the manufacturer’s specifications a normal car’s alternator charges between 13.7 and 14.2 volts.
- A battery should not be discharged below 11.8 volts as a general rule. A “deep-discharged” battery should be recharged as soon as possible to prevent permanent damage.

## Low Voltage Battery Protection

The Electronic Control Unit will cut-out at the LOW / MEDIUM / HIGH selected setting. Once the compressor has cut-out, it will not restart (cut-in) until the voltage rises.

The table below reflects the set points.

Battery Protection	12 VOLT		24 VOLT	
	Cut-out	Cut-in	Cut-out	Cut-in
LOW	9.6	10.9	21.3	22.7
MED	10.4	11.7	22.8	24.2
HIGH	11.3	12.5	24.6	26.0

**Note: these values are measured at the Electronic Compressor Driver input. It is important to note that poor / thin wiring and bad connections to the battery can cause a large voltage drop. When this occurs the Fridge switches off and will re-start again on a repeat cycle “hunting”.**

**NOTE: When connecting the fridge for the first time, it will look at the cut-in voltage.**

- If the battery protection is set on “High” the initial cut in voltage will be 12.5.
- If the battery is not fully charged the Fridge will not start. Simply select “Low” to start.
- When selecting “Low” the Fridge will operate within a voltage supply of 9.6-31.5Vdc.

# Operating your Fridge

## Dynamics of Temperature Settings

The compressor is controlled by the digital thermostat. It has a unique Multi - Speed (2,000 - 3,500 rpm) capability which makes it ideal for use in all mobile applications up to an angle of 35 degrees. It can function efficiently in extreme conditions where it is not uncommon to have ambient temperatures above 40°C.

## Inner Bin / Cooling Compartment / Thermostat Control

To control temperature, the thermostat sensor must be placed in a position in order to take an accurate temperature reading.

For practical purposes National Luna has elected to place this temperature sensor behind the metal surface forming the interior compartment of the Fridge/Freezer. Thus the switching on and off of the compressor will be controlled by the compartment surface area temperature.

The inner volume of the cooling bin (i.e. core/centre temperature) will take time to “pull down” to equalise the compartment temperature. (In practice it is common that the set temperature will be within 3°C of the core temperature).

Ambient temperatures surrounding the Fridge must also be taken into consideration. Very high ambient temperatures will affect the running time of the fridge. (e.g. The Fridge will run longer to maintain or reach the target temperature setting.)

## Temperature Guidelines

The following table is a guideline to setting the correct temperature range for different foodstuffs.

Recommended choice of temperatures	
Fresh fruits & vegetables Dairy products Smoked / prepared meats	3°C to 6°C
Cold beverages	0°C to 4°C
Short-term frozen meats	-6°C to -11°C
Frozen meats and fish Ice cream / frozen desserts	-18°C

## Conversion Chart

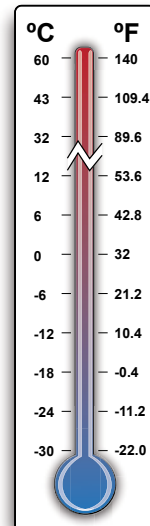

Celsius vs Fahrenheit



## National Luna Single Compartment Range: Models: NL40/52/55/65/80/125

### Operating your Single Compartment Fridge

Developed for performance at high ambient temperatures, minimum power consumption and high operating efficiency, these single compartment fridges are recognised as the most powerful in the world.

With the aid of an integrated electronic thermostat these units can be accurately set as a fridge or as a freezer.

#### Getting to know your portable Fridge

##### Single Compartment (NL40/52/55/65/80/125)

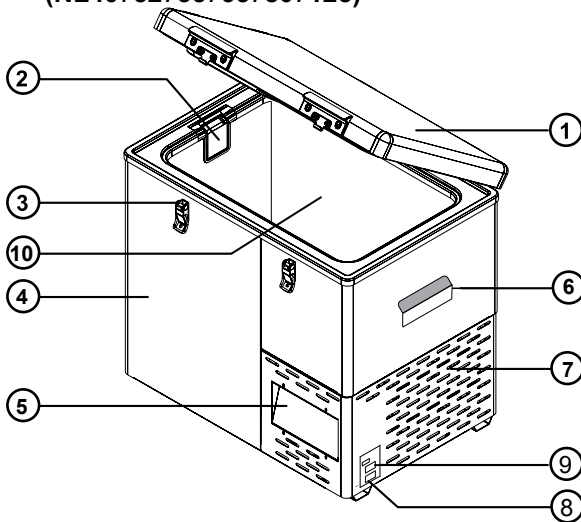

1. Lid
2. LED Interior light
3. Lid locking latches
4. Cabinet exterior
5. Control panel
6. Carry handles
7. Compressor area
8. AC input
9. DC input with fuse (15A)
10. Cooling Compartment (Evaporator)

# Operating your Single Compartment Fridge

## Main Control Panel

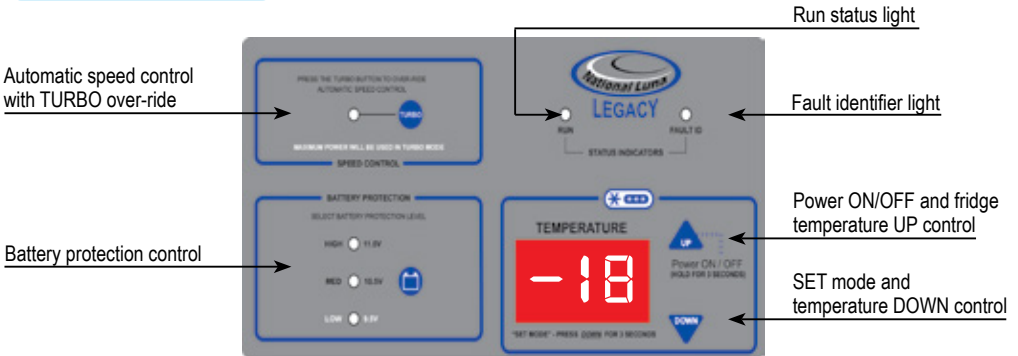

## On / Off Control

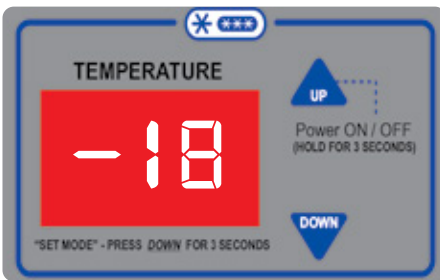

The refrigerator can be turned **ON** and **OFF** via the control panel.

Press and hold the  button for 3 seconds to turn the fridge **ON** or **OFF**.

If power to the refrigerator is interrupted, it will default to **ON** automatically.

Note: When the fridge is switched off, the interior light will still function if the unit is connected to a power source.

## Battery Protection Settings

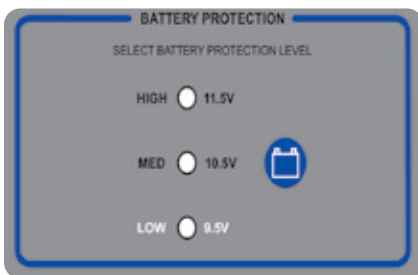

The refrigerator is equipped with a multi-level battery protection circuit.

The user has the choice of three voltage levels at which the compressor will shut down to protect against excessive battery discharge. (See page 9)

To change the protection level, press and hold the  button until the preferred level is reached.



Selecting the **“Low”** cut-out setting can cause excessive discharge resulting in damage to the battery.

**Note:** When changing the protection level the compressor will stop and restart 1 minute later (compressor start delay). When powered by an AC source, the battery protection level can be changed, but will only affect operation when the DC source is used.

# Operating your Single Compartment Fridge

## Smart Compressor Speed Control

This Fridge is fitted with a Smart Compressor Speed Control function which will vary the speed of the compressor in order to conserve power and optimise performance.



On initial plug-in, the compressor will have a one minute time delay before starting.

At the start of each cycle the Fridge will automatically run at low speed for 3 minutes to equalize gas pressure in the system.

### LOW Speed:

If both compartments are set to above 0 degrees.

The compartment temperatures are within 7 degrees of set temperature.

### MEDIUM Speed:

If the compartment with the coldest setting is set between 0 and -10 degrees.

The compartment temperatures are within 7 degrees of set temperature.

### HIGH Speed:

If any compartment is set to below -10 degrees.

The compartment temperature is more than 7 degrees higher than the set temperature.

## Speed Control Setting

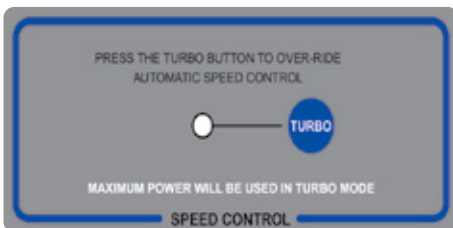

For situations where maximum cooling power is required, press and hold the “Turbo” button until the indicator is illuminated.

This will bypass the automatic control and force high speed operation.

**Selecting the “Turbo” mode will override the Smart Compressor Speed Control function and the unit will run at maximum speed**



Using the TURBO function may increase power consumption

# Operating your Single Compartment Fridge

## Setting the Temperature



The digital thermostat fitted to this refrigerator allows accurate setting of the desired cooling temperatures. Temperatures can be selected between +20°C and -30°C in 1°C increments.

When powering up the fridge the first time, the temperature inside the fridge will be reflected on the display. (NOTE: the previously set temperature will be in memory)

To select the new cooling temperature, press and hold the **DOWN** button until the display starts to flash. (The previous set temperature will be displayed).

Press **UP** or **DOWN** to raise or lower the desired temperature. The thermostat will accept the new setting and exit the setting mode 10 seconds after the last button was pressed. (It will now remember the new set temperature).

The temperature display will reflect the inner compartment temperature prior to the new setting. Provided the new setting is colder, the compressor will then switch on and cool the fridge further to the set point. (During this time the run indicator light will be displayed).

## Indicator Lights



Status indicators will identify the current operation of the refrigerator.

**RUN** - This indicator will be illuminated whenever the fridge Compressor is running and the compartment is being cooled.

**SOLID** - ● The Compressor is running.

**FLASH** - ● ½ second on, ½ second off... Compressor start up delay. There is a 1 minute delay before the compressor starts

**FLASH** - ● 1 second on, 1 second off... Compressor slow down cycle. The Compressor slows down to low speed before stopping (30 seconds)

**FAULT ID** - ● This indicator is used to identify fault conditions that may occur with the refrigerator such as low power supply. This indicator will flash a pre-determined number of times every 4 seconds when a particular fault occurs (see page 20).

### Operating your Dual Control Fridge

The Single door / Double door fridges in this Legacy range have only one compressor, but due to National Luna's unique Dual Control technology, the fridge and freezer compartments can be set independently. This is like having two fridges in one.

#### Single Door (NL50/60/90)

By reducing the fridge side insulation to 42mm thickness, National Luna offers a fridge/freezer to meet the demand for maximum fridge capacity where space is limited.

The freezer compartment has a separate internal lid. This prevents cold air escaping from the freezer when the main lid is opened, adding to the efficiency & ensuring stable temperatures within. Although the compartment temperatures can be independently set, it is recommended for the efficient functioning of the unit that the compartment with the thicker insulation (with internal freezer lid) be set as the colder freezer compartment.

#### Double Door (NL72/110)

The double door fridges have 2 independent lids to ensure that the minimum amount of energy is lost when opening a door. Both compartments have 60mm insulation to aid energy efficiency and this allows the compartments to be set independently without any efficiency restraints.

#### Single Door Range (NL50/60/90)

This has one lid covering both compartments and an internal freezer lid.

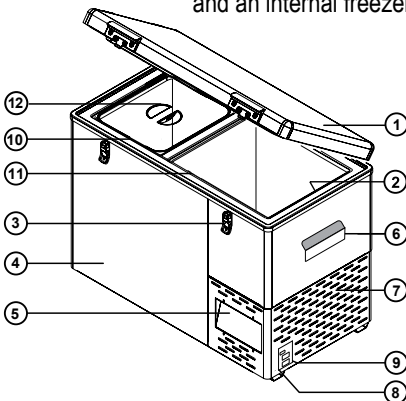

- 1. Lid
- 2. LED Interior light
- 3. Lid locking latches
- 4. Cabinet exterior
- 5. Control panel
- 6. Carry handles
- 7. Compressor area
- 8. AC input

#### Double Door Range (NL72/110)

This has two lids, one for each compartment.

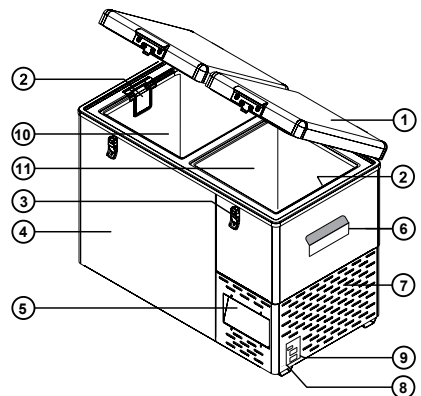

- 9. DC input with fuse (15A)
- 10. Left Compartment
- 11. Right Compartment
- 12. Internal Freezer Lid

# Operating your Dual Control Fridge

## Main Control Panel

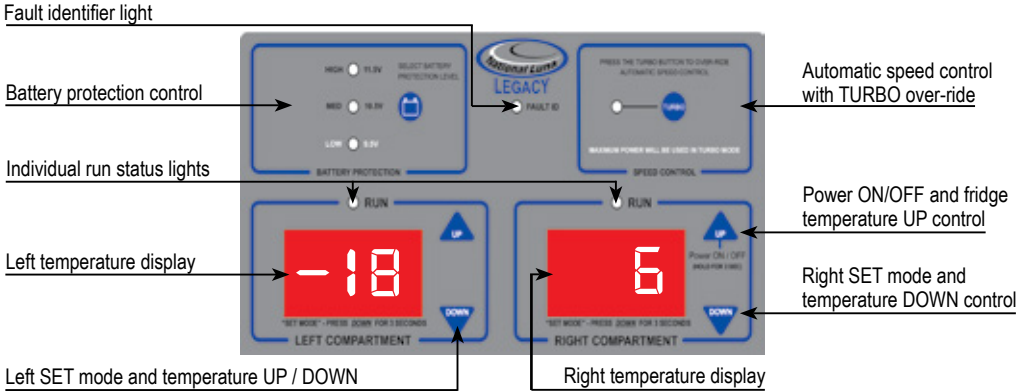

## On / Off Control

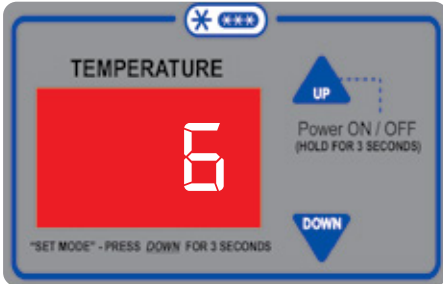

The refrigerator can be turned **ON** and **OFF** via the control panel.

Press and hold the  button for 3 seconds to turn the fridge **ON** or **OFF**.

If power to the refrigerator is interrupted, it will default to **ON** automatically.

Note: When the fridge is switched off, the interior light will still function if unit connected to a power source.

## Battery Protection Settings

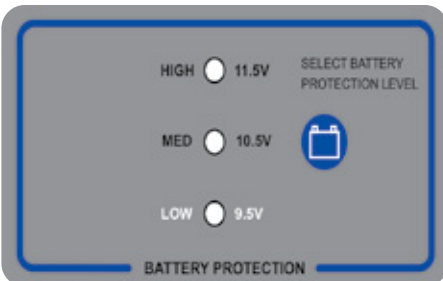

The user has the choice of three voltage levels at which the compressor will shut down to protect against excessive battery discharge.

To change the protection level, press and hold the  button until the preferred level is reached.

(Refer to page 9).

Whenever the battery protection setting is changed, the compressor will stop and the 1 minute compressor start delay will be active.



# Operating your Dual Control Fridge

## Smart Compressor Speed Control

This Fridge is fitted with a Smart Compressor Speed Control function which will vary the speed of the compressor in order to conserve power and optimise performance.



On initial plug-in, the compressor will have a one minute time delay before starting.

At the start of each cycle the Fridge will automatically run at low speed for 3 minutes to equalize gas pressure in the system.

### **LOW Speed:**

If both compartments are set to above 0 degrees.

The compartment temperatures are within 7 degrees of set temperature.

### **MEDIUM Speed:**

If the compartment with the coldest setting is set between 0 and -10 degrees.

The compartment temperatures are within 7 degrees of set temperature.

### **HIGH Speed:**

If any compartment is set to below -10 degrees.

The compartment temperature is more than 7 degrees higher than the set temperature.

## Speed Control Setting

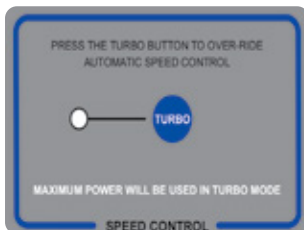

For situations where maximum cooling power is required, press and hold the “Turbo” button until the indicator is illuminated.

This will bypass the automatic control and force high speed operation.

**Selecting the “Turbo” mode will override the Smart Compressor Speed Control function and the unit will run at maximum speed**



Using the TURBO function may increase power consumption

# Operating your Dual Control Fridge

## Setting the Temperature



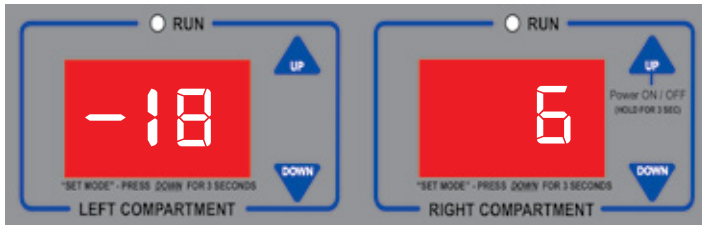

**NB - Set one thermostat at a time**

Dual Control Refrigerators have two thermostats allowing individual temperatures to be selected for each of the cooling compartments.



To select the cooling temperature, press and hold the  button until the display starts to flash.



Press  or  to raise or lower the desired temperature. The thermostat will accept the new setting and exit the setting mode 10 seconds after the last button was pressed. The same procedure is used on both thermostat controls. (NOTE: You can only set one thermostat at a time).

## Minimum Temperature Settings

National Luna Model	Left Compartment	Right Compartment
50	-18	-24
60	-24	-18
72	-24	-24
90	-24	-18
110	-24	-24

## Indicator Lights

Status indicators will identify the current operation of the refrigerator. (see main control panel on page 16)

- RUN** - This indicator will be illuminated whenever the fridge Compressor is running and the compartment is being cooled.
- SOLID** - ● The Compressor is running.
- FLASH** -  1/2 second on, 1/2 second off... Compressor start up delay. There is a 1 minute delay before the compressor starts
- FLASH** -  1 second on, 1 second off... Compressor slow down cycle. The Compressor slows down to low speed before stopping (30 seconds)
- FAULT ID** -  This indicator is used to identify fault conditions that may occur with the refrigerator such as low power supply. This indicator will flash a pre-determined number of times every 4 seconds when a particular fault occurs (see page 20).

## Dual-direction Lid (Models: NL50 & NL52 only)

A special feature of the NL50 and NL52 is the ability to change the direction in which the lid opens.

The most common configuration is the front-opening direction (shown on the right).

If the application prevents the lid from opening fully or the refrigerator is installed long ways into a vehicle, it may be advantageous to use the side-opening configuration.

The Fridge is supplied in the front-opening configuration. In order to change the lid direction, follow these steps :

1. Close the lid. Remove both front latches and lid handles.
2. Re-fit one of the latches and lid handles to the alternative latch positions on the side of the refrigerator. (Keep the spare parts safe)
3. Remove all three hinges from the rear of the refrigerator. Also remove the hinge cover plates from the alternative hinge locations.
4. Re-fit two of the hinges on the side of the refrigerator.
5. Align the lid and ensure that it closes fully before tightening the screws.
6. Keep the spare hinge and screws in a safe place.

The Fridge will now be in the side-opening configuration

**NOTE:** Take care not to apply excessive pressure when locating the screws to the inside retaining nuts. (They can be pushed too far back or incorrectly angled).

Tip - The optional protection jacket has a side pocket which is ideal for keeping the spare hinge and latch parts.

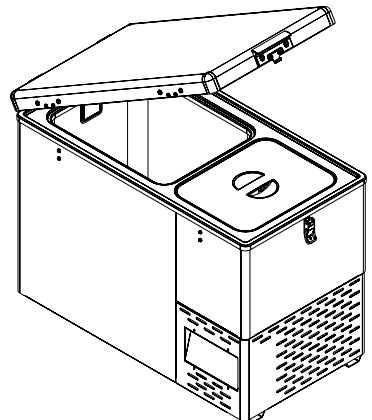
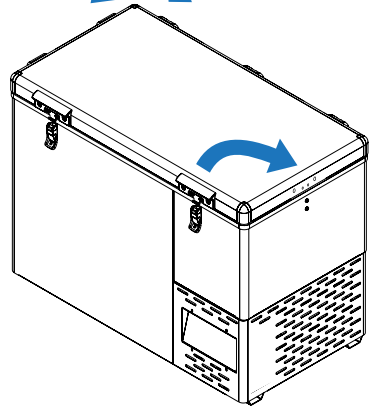
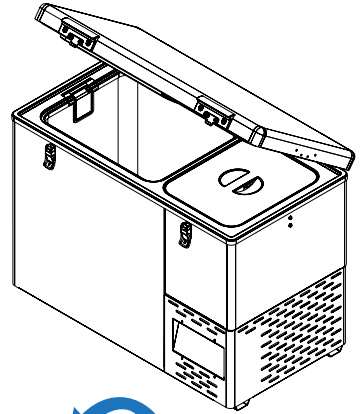

# Trouble Shooting

## Indicator Lights

Status indicators will identify the current operation of the refrigerator.

- RUN** - This indicator will be illuminated whenever the fridge Compressor is running and the compartment is being cooled.
- SOLID** - ● The Compressor is running.
- FLASH** - ☀ ½ second on, ½ second off... Compressor start up delay. There is a 1 minute delay before the compressor starts
- FLASH** - ☀ 1 second on, 1 second off... Compressor slow down cycle. The Compressor slows down to low speed before stopping (30 seconds)
- FAULT ID** ☀ This indicator is used to identify fault conditions that may occur with the refrigerator such as low power supply. This indicator will flash a pre-determined number of times every 4 seconds when a particular fault occurs.

### FAULT DESCRIPTION

#### NUMBER OF FLASHES

- 1 ☀ Low voltage. This is shown when the DC supply voltage is low. The battery could be flat, wiring losses are too high or there is a poor connection to the power source.
- 2 ☀ Fan over-current cut-out. There is a problem with the ventilation fan. It is possible that the ventilation fan is damaged.
- 3 ☀ Motor start error. The compressor has not started successfully. This can happen in extreme environments where the refrigerator is heavily loaded & temperature is very high.
- 4 ☀ Minimum speed error. The motor cannot maintain a minimum speed of 1900 rpm. This can be the result of an Electronic Compressor Driver failure.
- 5 ☀ Thermal cut-out. The electronic circuitry has over-heated. This happens in very hot environments. This can occur when the fridge is over-loaded with warm contents and the ambient temperature is high. The electronics will re-set when the temperature has dropped.
- 6 ☀ Electronic Compressor Driver hardware failure.

# Trouble Shooting

In the event of unusual or undesired operation, consult the table below before contacting a service agent.

<b>PROBLEM</b>	<b>POSSIBLE CAUSE</b>	<b>REMEDIAL ACTION</b>
The fridge will not run when connected to 12V, but only when connected to 230V mains.	12 Volt polarity reversed. The battery is discharged. The DC supply has inadequate wiring, causing voltage loss. (see page 8)	Check polarity to battery is correct. Recharge the battery. Ensure all connections are secure. Ensure supply has 4mm <sup>2</sup> wire or thicker and that the vehicle's body is not used as an earth.
The Fault ID light is flashing <b>once every 4 seconds.</b>	Fridge is initially connected to a battery that is not fully charged.	Select "Low" on battery protection (see page 9)
The ventilation fan is noisy or not running.	The ventilation fan is blocked or damaged. There is excessive dust or dirt build-up on the fan.	Check the ventilation fan for obstructions. Ensure sufficient space is allowed around the ventilation area. (page 6)
The Fault ID light is flashing <b>twice every 4 seconds.</b>	Fan damaged.	If the fan is broken, return the refrigerator to an authorised agent for repair (see page 23).
The Fault ID light is flashing <b>three times every 4 seconds.</b>	The compressor failed to start correctly. High pressure due to over-load or Electronic Compressor Driver failure.	Under high pressure conditions this fault will rectify itself automatically when gas pressures equalise. Continuous 3-flash conditions may require Electronic Compressor Driver replacement by an authorised service agent. (see page 22)
The Fault ID light is flashing <b>four times every 4 seconds.</b>	The compressor is not maintaining the correct minimum speed.	Continuous 4-flash conditions may require Electronic Compressor Driver replacement by an authorised service agent. (see page 22)
The Fault ID light is flashing <b>five times every 4 seconds.</b>	Compressor area is over-heated. The cooling fan is in-operative. Ambient temperature very high. Fridge over-loaded.	Check fan. Check for inadequate ventilation (see page 6) Wait for ambient temperature to drop. (see page 20)
The Fault ID light is flashing <b>six times every 4 seconds.</b>	Electronic Compressor Driver failure (controller detects abnormal parameters.)	Replace NL25-C3 Electronic Compressor Driver (see page 22)
The thermostat display is showing "— — —"	The internal temperature probe is faulty, damaged or disconnected.	Contact a National Luna service agent for a probe replacement.

# General Maintenance



## Disconnect the Power Supply

Failure to disconnect the power supply may result in electrical shock or personal injury.

## Removal of Side Cover

Tip refrigerator so that the grill area is at the top. (Pic 1) Remove the screws from the face plate (4x M3 screws) and from the power inlet area (2x M3 screws - Pic 2). Then remove the screws from the base plate (6x M5 screws - Pic 3). The grill will now slide away easily. (Pic 4)

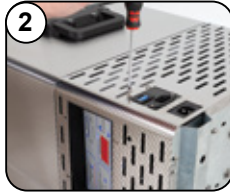

## Removal of the Electronic Compressor Driver

It will be necessary to remove the colour coded wiring from the electronics using a pair of long nosed pliers (Pic 5). Using a screw driver, remove the mounting screw that holds the Electronic Compressor Driver (Pic 6). Remove the Electronic Compressor Driver and the 3 pin coupler as shown (Pic 7). When re-connecting new electronics take care to adhere to the wire colour coding. (Pic 8)

**Incorrect connection may cause irreparable damage to the electronics**

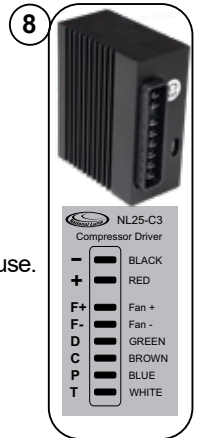

## Replacing the DC inlet fuse

See pic 10 for DC removal and replacement of the blue 15 Amp automotive blade fuse.



## Replacing the AC Power supply

Disconnect the cables and slide out the power supply to replace.



# General Maintenance

## Replacing the Temperature Probe

The temperature probe (Pic 11, 12 & 13) is inserted into the refrigerator box and clips onto the face plate PCB. A soft putty compound is pressed around the probe cable to prevent condensation / water ingress. Ensure that the new probe is inserted to the same depth as the original probe.

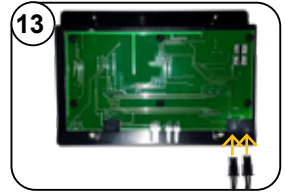
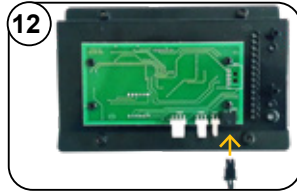

## Cleaning the Condenser / Replacing the Fan

Fluff and dust can collect around the fan and condenser area which can choke the air flow and affect the fridge performance (Pic 15).

The fan is attached to the condenser unit. In order to access the fan, the compressor has to be removed. Loosen the compressor mounting bolts (Pic 14) then proceed to swing the compressor outwards (Pic 16). Remove the fan and replace (Pic 17).

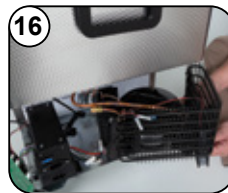

## Removing & Replacing the Interior LED Light

Using a small screw driver, push up the clip that holds the LED housing in place. (Pic 19). Unclip the wires and replace the unit (Pic 20 & 21)

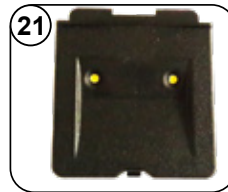

# General Maintenance

## Door Seal and Adjustment (Loose Latch Condition)

This refrigerator utilises a multi-cavity door seal which gives exceptional sealing capability. Under hot conditions, and after loading the fridge, the door could be “sucked” closed. (A vacuum is formed inside the Fridge causing difficulty to open and a temporarily loose latch condition).



The material used tends to be soft and pliable under warm conditions and may harden during cold/winter conditions tending to retain it's compressed state.

(The door latch can be slightly loose under this condition). By carefully using a hair dryer the seal can be softened and returned to it's expanded state.



It is very simple to adjust the door lid hinges at the rear of the fridge to compensate for this “play/loose door latch condition”. Loosen the screws of the door hinges on the main body of the fridge (bottom part of the hinge).

Lightly depress the back of the door lid evenly on it's length and re-tighten the screws. The door latches will now be tight.



Adjust lid

Loosen and re-tighten screws.

## Removing and Replacing Multi-Cavity Door Seal

Over time the door seal adopts and moulds/compresses itself into a fixed shape (especially in winter and cold climate conditions.)

Simply pull the seal from a corner and remove.

1. One can clean the seal and place it in the sun to soften the material.
2. It can also be softened using a hair dryer to attain it's uncompressed state.
3. Alternatively place the entire seal in hot water until soft and pliable.

Refit the seal by simply pressing it back in place.





## Care and Cleaning

Your refrigerator should be cleaned in the following manner, both on installation and when defrosting. It is important that you keep the inside and outside of your refrigerator/freezer clean to prevent bacteria and odours from forming.



Remove all food and **disconnect the power source before cleaning.**

**Do not use any ammonia based cleaning products as this may have an adverse chemical reaction with plastic components.**

Do not dry the fridge in direct sunlight.

### Interior:

Wash the interior of the refrigerator with a mild household cleaner (dishwashing liquid) or 2 tablespoons of bicarbonate of soda diluted in 250ml of warm water. Rinse with warm water and dry.

### Fridge / Freezer Odours:

Place an open container of Bicarbonate of Soda into your fridge or freezer to absorb odours. Stir every two weeks and replace every two months.

### Exterior:

Wash the exterior with the same solution as for the interior.

**N.B. DO NOT use a garden hose to wash the refrigerator exterior as this could jet water into the electronics.**

#### DO'S

- Routine simple and gentle cleaning
- Use cleaners showing "Suitable For Stainless Steel"
- Employ repeated Routine Cleaning rather than an aggressive single cleaning

#### DON'TS

- Use coarse abrasive powders
- Use metallic scourers (or brushes with metal bristles)
- Use the "Silver Cleaners"
- Use any ammonia based cleaning agents

### Stainless Steel - (Grade 430)

Because of its reputation for durability, Stainless Steel is sometimes assumed to be indestructible, and therefore subjected to misuse or even abuse. Care should be taken to avoid such "abnormal" use.

- **Avoid prolonged contact with heavily spiced or salty food, raw bloody meat, some salad dressings, citrus juice (especially lemon juice), etc.**
- **Do not leave ordinary steel or cans in contact with stainless steel under damp conditions as an electrolytic reaction occurs and causes stains.**

**ROUTINE CLEANING:** Stainless Steel's best friends are quite simply soap, or mild diluted detergent in warm water, applied with a soft cloth or synthetic sponge. Occasionally the use of a fine synthetic scourer (green "Scotch-Brite"™) or a brush with nylon bristles may be used. Rinse well, dry with a soft cloth.



## **NATIONAL LUNA LIMITED WARRANTY** **SOUTH AFRICA (Only)**



This National Luna Warranty supersedes any other advertised Guarantee or Warranty provided with this appliance by any wholesaler or retailer.

National Luna warrants this product to be free from defects in materials and / or workmanship under normal use and service to the original purchaser subject to the following :

1. At any time within THREE YEARS from the date of purchase by the original purchaser, National Luna will at its discretion replace or repair (the part only) without cost to the owner, through an authorised service agent, any part found to be defective by National Luna.

**Where parts are replaced by an authorised service agent, the labour account for the work done will be for the owner's account.**

2. This warranty does not apply to light bulbs, fuses, cooling fans or items where the length of life depends on the amount of use and care given.
3. This warranty is valid in South Africa only.
4. National Luna may consider a warranty void if modifications have been made to this appliance which may cause undesirable or hazardous operation or may be the cause of the malfunction of this product.
5. National Luna shall not be responsible for any damages of any kind resulting from incorrect voltages or faults with regards to power supply which fall outside of the appliance operating specifications.
6. National Luna shall not be responsible for damage to the appliance caused by negligent use, storage of hazardous chemicals, use of corrosive substances, fire, flood, civil-disturbances, lightning or any other natural phenomenon.
7. Warranty returns to the factory for repairs - in the event where the unit has been shipped to the factory for repairs, transport costs will be for the owners account.
8. National Luna will not accept any responsibility for the consequential loss or damage caused by, or due to the malfunctioning of this appliance.
9. National Luna shall not be held responsible for any injuries to persons caused by the incorrect or negligent usage of this appliance.
10. Repair work to be done in terms of this warranty must be referred to National Luna for written authorisation before any work is carried out.
11. National Luna reserves the right to refuse repair or service under warranty if the Warranty registration card or original proof of purchase cannot be produced.
12. Proof of purchase and purchase date must be presented with submission of a warranty claim. All refrigerators have a unique serial number.

**(Removal of the serial number on the appliance will render this warranty void).**

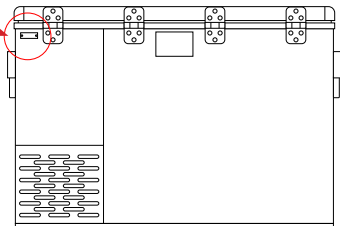

## **NATIONAL LUNA LIMITED WARRANTY** **INTERNATIONAL**

This National Luna Warranty in South Africa cannot be applied outside the South African borders for practical reasons.

1. National Luna has a world wide distributor network. These distributors import products and carry the warranty (at their cost) in line with the various countries conditions of sale.
2. Cross border customs and duties apply. A National Luna manufactured product that is returned to the factory in South Africa will have the South African warranty applied. However, all transport costs incurred will be for the purchaser's account.
3. It is important to note that a private purchase of a refrigerator in South Africa and exported will not carry a warranty. Any labour repairs and parts required would incur costs in foreign currency and be for the owner's account.
4. In the event of a National Luna refrigerator being fitted as standard equipment in caravans and trailers and subsequently being exported from South Africa, the warranty must be carried by the persons responsible for importing into a country other than South Africa.
5. It is recommended that National Luna products be purchased from the authorised importer of that particular country who would carry the applicable warranty and back-up service.

## **WARRANTY & SERVICE INFORMATION (AUSTRALIA)**

### **NATIONAL LUNA PORTABLE FRIDGE/FREEZERS**

This information applies only to National Luna products imported and first sold by the official Australian importer – AECAA Pty Ltd – Trading as Automotive Electrical & 4WD Accessories either directly or via an authorised dealer who sourced the product from AECAA Pty Ltd.

(eg: privately imported or “grey” imports or units purchased as second hand are not covered by this warranty.) Please ensure you provide a Serial Number (located on the rear of the refrigerator or service enquiry. Removal of the Serial Number will void the Warranty)

Our goods come with guarantees that cannot be excluded under the Australian Consumer Law. You are entitled to a replacement or refund for a major failure and compensation for any other reasonably foreseeable loss or damage.

Our services come with guarantees that cannot be excluded under the Australian Consumer Law.

It is recommended to care for your National Luna Fridge/Freezers as per the instructions on page 25. National Luna Service Agents will carry out investigations during warranty servicing / inspections. Should your Fridge/Freezer show signs of being subjected to water or environmental elements during inspection, warranty may be void, and the owner may be responsible for incurring any repair costs associated.

### **Australian Voluntary Warranty Against Defects**

Further to the rights of consumers as covered within the Australian Consumer Law, AECAA Pty Ltd trading as Automotive Electrical & 4WD Accessories (AE4A) as the Australian importer/distributor, offers the following voluntary warranty:

1. This warranty does not apply to light bulbs, fuses, cooling fans or items where the length of life depends on the amount of use and care given.
2. This warranty is valid in Australia only.
3. AECAA Pty Ltd may consider a warranty void if modifications have been made to this appliance which may cause undesirable or hazardous operation or may be the cause of the malfunction of this product.
4. AECAA Pty Ltd shall not be responsible for any damages of any kind resulting from incorrect voltages or faults with regards to power supply which fall outside of the appliance operating specifications.
5. AECAA Pty Ltd shall not be responsible for damage to the appliance caused by negligent use, storage of hazardous chemicals, use of corrosive substances, fire, flood, civil-disturbances, lightning or any other natural phenomenon.
6. Warranty returns to Service Agents for repairs - in the event where the unit has been shipped to an Authorised National Luna Service agent for repairs, transport costs will be at the account of AECAA Pty Ltd. Should the product be found not to have an identifiable issue by the Authorised National Luna Service Agent, the owner may be required to pay the transport or inspection costs.

## **Australian Voluntary Warranty Against Defects - continued**

7. AECAA Pty Ltd will not accept any responsibility for the consequential loss or damage caused by, or due to the malfunctioning of this appliance.
8. AECAA Pty Ltd shall not be held responsible for any injuries to persons caused by the incorrect or negligent usage of this appliance.
9. Repair work to be done in terms of this warranty must be referred to AECAA Pty Ltd for written authorisation before any work is carried out.
10. Proof of purchase and purchase date must be presented with submission of a warranty claim. All refrigerators have a unique serial number which should not be removed.

### **Owners Handbook**

National Luna products are manufactured in South Africa and an Owner's Handbook is packed with each unit. On pages 26 & 27 is a section titled National Luna Warranty – South Africa. These pages DO NOT apply to units sold in Australia and can be disregarded.

### **Warranty Registration Form**

Within 14 days of purchase, complete and submit the Warranty Registration form on page 31.

#### **3 Year Warranty** (only applicable to the original purchaser of a new unit)

Covering parts and labour from the date of first purchase, excluding any damage as a result of abuse of impact or incorrect power supply. The unit will be repaired or replaced at the discretion of AE4A.

To make a claim please contact the seller or AE4A or any of the Authorised Service Agents on the website at [www.nationalluna.com.au](http://www.nationalluna.com.au). You are responsible to return the unit to the original point of sale, or to an authorised Service Agent, or to AE4A.

Please contact AECAA Pty Ltd or the dealer from whom you purchased the product for any warranty claim or service needs.

Any warranty queries should be emailed to: **[warranties@nationalluna.com.au](mailto:warranties@nationalluna.com.au)**



A list of current Service Agents and more product information is available at:

**[www.nationalluna.com.au](http://www.nationalluna.com.au)**

## Fridge start-up display sequence & identifying the firmware version installed in your Fridge

### Introduction

From time to time there are improvements made to the functioning of the refrigerator unit. In some cases, a software/programming change is necessary.

In order to identify which model and program you have, there is an imbedded code which can be read on start-up of the unit. The following steps occur on start-up.

#### Single Compartment

Step 1:



The display will reflect flashing “888” upon initial start-up

Step 2:



The display will then change to reflect the program (eg. **F03** on the single compartment unit)

With a dual compartment unit, the model of the fridge is reflected on the left compartment display (in this example an NL 50 dual control unit) and the program (eg. **F04**) will reflect on the right compartment display.

Step 3:



The display will reflect the relevant temperatures measured inside the cooling compartments.

#### Dual Compartment

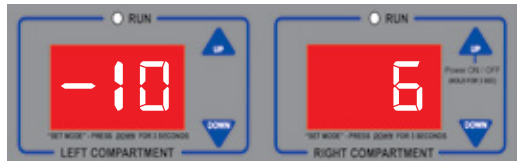
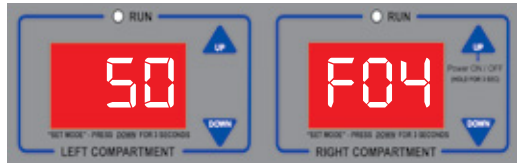

To reset to a new temperature of choice, refer to pages 14 and 18.

## Warranty Registration Form (Australia)

**Form only necessary for registration of a new National Luna Portable Refrigerator.  
Submit your registration within 14 days of purchase.**

**Please fill this out, scan & email to... [warranties@ae4a.com.au](mailto:warranties@ae4a.com.au)  
or submit online on..... [www.nationalluna.com.au](http://www.nationalluna.com.au)**

**Please enter accurate information in the fields below.  
Errors can result in the registration not being completed.**

Name: \_\_\_\_\_

Surname: \_\_\_\_\_

Email: \_\_\_\_\_

Telephone Number: \_\_\_\_\_

Address: \_\_\_\_\_

\_\_\_\_\_

State: \_\_\_\_\_ Postal Code: \_\_\_\_\_

Refrigerator Type: \_\_\_\_\_

Date of Purchase: \_\_\_\_\_ State of Purchase: \_\_\_\_\_

Dealer / Distributor: \_\_\_\_\_ Invoice Number: \_\_\_\_\_

Serial Number: \_\_\_\_\_ (located on fridge rear panel and original packaging)

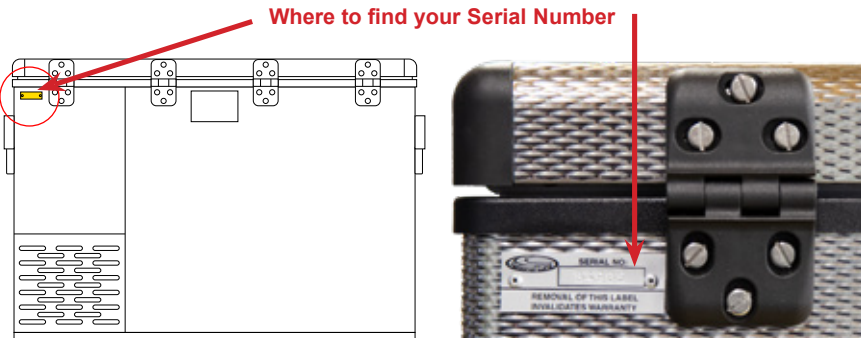



Designed & manufactured in South Africa by National Luna

### STAINLESS STEEL - (GRADE 430)

Because of its reputation for durability, stainless steel is sometimes assumed to be indestructible, and therefore subjected to misuse or even abuse. Care should be taken to avoid such "abnormal" use.

- **Avoid prolonged contact with heavily spiced or salty food, raw bloody meat, some salad dressings, citrus juice (especially lemon juice), etc.**
- **Do not leave ordinary steel or cans in contact with stainless steel under damp conditions as an electrolytic reaction occurs and causes stains.**

**ROUTINE CLEANING:** Stainless steel's best friends are quite simply soap, or mild diluted detergent in warm water, applied with a soft cloth or synthetic sponge. Occasionally the use of a fine synthetic scourer (green "Scotch-Brite™") or a brush with nylon bristles may be used. Rinse well, dry with a soft cloth.

**SAFETY PRECAUTIONS:** The appliance is not to be used by persons (including children) with reduced physical, sensory or mental capabilities, or lack of experience and knowledge, unless they have been given supervision or instruction.

- Children being supervised must not to play with the appliance.
- Appliance shall not be exposed to rain
- Do not store explosive substances a flammable propellant in appliance

#### **THIS APPLIANCE IS INTENDED TO BE USED IN:**

- Staff kitchen areas in shops, offices and other working environments
- Farm houses and by clients in hotels, motels and other residential type environments
- Bed and breakfast type environments
- Catering and similar non retail applications.
- Suitable for camping use

**DISPOSING OF YOUR OLD APPLIANCE:** Electrical and electronic appliances often contain materials which, if handled or disposed of incorrectly, could be potentially hazardous to human health and to the environment. They are, however, essential for the correct functioning of your appliance. Therefore please do not dispose of it with your household waste. Please dispose of it at your local community waste collection / recycling centre and ensure that it presents no danger to children while being stored for disposal. The plug must be rendered useless and the cable cut off directly behind the appliance to prevent misuse. Take care not to damage the pipework at the back of it before or during transportation to an authorised collection depot. In this way, refrigerant in the pipework and oil in the compressor will be contained, and will not leak out into the environment.

**National Luna Fridges have been tested to international safety specifications**

SANS 60335-1:2018 Ed 3,1

SANS 60335-2-24:2014 Ed 5,1

IEC 60335-1:2016 Ed 5,1

IEC 60335-2-24:2012 Ed 7,1

---

## **Australian Distributor of National Luna Refrigeration & Accessories**

Automotive Electrical & 4WD Accessories

(07) 5540 7877

warranty@ae4a.com.au

**www.nationalluna.com.au**