

AVENTON

User Manual

Aventure.2 Electric Bicycle



Scan to watch assembly video

Thank you for purchasing the Aventon Aventure.2 Ebike.

We take pride in bringing you a quality product that will offer years of enjoyment. Please read and understand this manual fully before assembling and riding your bike. If you have questions after reading this manual, please refer to aventon support or contact us by email or give us a call.

We are here to help!

Aventon Support Center: <https://www.aventon.com/pages/support>

Customer service link: <https://support.aventon.com/contact-us>

Phone: 1-866-300-3311

TABLE OF CONTENTS

USING THIS MANUAL	02
GENERAL SAFETY	02
CHARGER SAFETY	05
SPECIFICATIONS	08
INSTALLATION INSTRUCTION.....	10
BATTERY CHARGING (LOCK & REMOVAL)	17
OPERATION INSTRUCTION.....	21
USER MAINTENANCE AND SERVICE INSTRUCTIONS.....	23
TROUBLESHOOTING	26
LIMITED WARRANTY	27
LINK TO ASSEMBLY VIDEO AND ONLINE RESOURCES	29

USING THIS MANUAL

This manual contains details of the product, its equipment, and information on operation, maintenance, and other helpful tips for owners. Read it carefully and familiarize yourself with the ebike before using it to ensure safe use and prevent accidents. This manual contains many warnings and cautions concerning the safe operation and consequences if proper setup, operation, and maintenance are not performed. All information in this manual should be carefully reviewed and if you have any questions you should contact Aventon immediately.

The notes, warnings, and cautions contained within the manual and paragraphs are marked by the triangular Caution Symbol at the left side should be given special care. Users should also pay special attention to information marked in this manual beginning with NOTICE.

Keep this manual, along with any other documents that were included with your bike, for future reference, however all content in this manual is subject to change or withdrawal without notice. Visit <https://www.aventon.com/pages/documents> to view and download the latest version. Aventon makes every effort to ensure the accuracy of its documentation and assumes no responsibility or liability if any errors or inaccuracies appear within.

Because it is impossible to anticipate every situation or condition that will occur while riding, this manual makes no representations about the safe use of bikes under all conditions. There are risks associated with the use of any bike that cannot be predicted or avoided and are the sole responsibility of the rider.

GENERAL SAFETY

INSTRUCTIONS PERTAINING TO RISK OF FIRE or ELECTRIC SHOCK

IMPORTANT SAFETY INSTRUCTIONS

WARNING! When using this product, basic precautions should always be followed, including the following:

- a) Read all the instructions before using the product.
- b) To reduce the risk of injury, close supervision is necessary when the product is used near children.
- c) Do not put fingers or hands into the product.
- d) Do not use this product if the flexible power cord or output cable is frayed, has broken insulation, or any other signs of damage.
- e) This equipment is not intended to be used at ambient temperatures less than -4°F (-20°C) or above ambient temperatures of 113°F (45°C).
- f) The battery is intended to be charged when the ambient temperature is between 32°F (0°C) and 104°F (40°C). Never charge the battery when ambient temperatures are outside this range."

WARNING! It is your responsibility to comply with all traffic related laws and to use proper equipment. This includes appropriate cycling attire and bike maintenance.

Observe all local bicycle traffic laws and regulations.

Observe regulations about bicycle lighting, licensing riding on pavements/sidewalks, bike path and trail use, helmet laws, child laws relating to cycling, and special bicycle traffic laws, it is your responsibility to know and obey your local laws.

- When riding a bike, always wear a properly fitted helmet that covers the forehead. Many locations require specific safety devices. It is your responsibility to familiarize yourself with the local laws, rules, and regulations where you ride and to comply with all applicable laws, including equipping yourself and your bike as the law requires.
- Unless otherwise stated, a rider's weight and luggage should not exceed 400lbs/181kg.
- Before you ride your bike, always check to make sure everything is working properly and correctly aligned.
- Be familiar with the controls of your bicycle, such as brakes, pedals and shifting etc..
- Keep all body parts or any obtrusive objects away from the sharp chainrings when pedaling. Failure to wear proper attire could lead to injuries.
- While riding, remember you are sharing the road or path with others. i.e. motorists, pedestrians and other cyclists.

- Always be a defensive rider. Always assume that others do not see you and expect the unexpected
- Always be aware of your surrounds. Be alert and responsive to:
 - 1) Motor vehicles of all types and in all directions.
 - 2) Unexpected movement of obstacles.
 - 3) Nearby pedestrians.
 - 4) Children or animals in the area.
 - 5) Imperfections of bike paths or paved roads including potholes, uneven surfaces, loose gravel construction and debris.
 - 6) Warning, hazard and yield signs.
- Ride in designated bike lanes when available and always ride in the direction of traffic.
- Acknowledge and stop at ALL stop signs and traffic lights.
- When coming to a complete stop, look both ways at street intersections before continuing onward.
- Use official hand signals for turning and stopping.
- Do not ride with headphones.
- Never hold onto another vehicle.
- Do not weave through traffic or make unexpected moves or turns.
- Rules that govern the right-of-way for motorists apply to cyclists. A bicyclist should always be prepared to yield.
 - Do not ride while under the influence of alcohol or drugs.
 - Avoid riding in bad weather when visibility is obscured, for examples dawn, dusk, or in the dark such conditions increase the risk of accident.

Wet Weather

It is recommended to not ride in wet weather if avoidable. Ride in wet weather only if necessary.

electric bike is not meant for use in heavy rain, or streams. Never immerse or submerge this product in water or liquid as the electrical system may be damaged.

- In wet weather you need to take extra care when operating this bike.
- Decrease riding speed to help you control the bike in slippery conditions.
- Brake earlier since it will take longer to slow down and come to a stop than when operated in dry conditions.
- Take care to be more visible to others on the road. Wear reflective clothing and use approved safety lights.
- Road hazards are more difficult to see when wet; proceed with caution.

NIGHT RIDING

Cyclists should exercise extra caution when riding at night. Bicyclists are very difficult for motorists and pedestrians to see in the dark and in many cases, night riding can be more dangerous than day riding.

Individuals of an appropriate age who are aware of the increased risks should take extra care when riding at dawn, dusk or at night. Please note that it is important to choose suitable apparel and special sized equipment when riding in unfavourable conditions to reduce the risk of injury.

Warning! Reflectors should not worn as a substitute for required lighting. Cyclists are near to invisible for other cyclists and motorists if the necessary lights and reflective gear are not used. If you ride at night, take all required precautions to make yourself visible through the use of lights and reflectors. Lack of adequate lighting measures may result in serious injury or death. As a moving cyclist, reflectors are designed to reflect off of car and street lights to help you become more visible and recognizable when riding.

Caution! Reflectors and their mounting brackets should be checked regularly to ensure they are clean, straight and securely mounted. Check to be sure you comply with all local laws about night riding. The followings are recommended.

- It is important you take steps to enhance your visibility by wearing light-colored, reflective clothing and accessories. There are plenty of proper reflective gear options that can be worn: Vests, armbands, leg bands, stripes on your helmet, and blinker attached to your body and or bicycle.
- Make sure your clothing or miscellaneous items do not obstruct the visibility of your reflectors and lights.

- Make sure that your bicycle is equipped with reflectors for riding at dawn, dusk or at night.
- Always ride slowly when riding at night.

Throttle on Demand

With throttle on demand, you can throttle the bike from a complete stop. This feature is to help give you that extra push when you need it on a steep hill, when hitting multiple stops signs, etc. However, we strongly recommend to **pedal first and throttle second** to ensure proper stability and preparedness.

Assembly and Fit

Correct assembly and fit are essential elements to ensure your bicycling safety, performance, and comfort. Even if you have the experience, skill, and tools to complete these essential steps before your first ride, Aventon recommends having a certified, reputable bike mechanic to check your work.

NOTICE: If you do not have the experience, skill, and tools to complete assembly and fit, Aventon highly recommends having a certified, reputable bike mechanic complete these procedures as well as any future adjustments or tuning.

NOTICE: A critical aspect of assembling your bike is securing the front wheel and checking the tightness of the rear wheel axle nuts. Aventon bikes use bolted on, through axle or quick release front wheel mounting mechanism and the rear wheel is bolted on. These mechanisms may become loose or unsecured during shipment or over time. The torque and security of all wheel mounting hardware should be inspected upon arrival and on a regular basis. Both wheels need to be properly secured before operating your bike.

Mandatory Equipment and Use Locations

Before riding, ensure you have all required and recommended safety equipment and are following all laws pertaining to use an electric bike in your region. For example, these laws may specify the need for mandatory equipment, use of hand signals, and where you can ride.

Changing Components or Attaching Accessories

The use of non-original components or spare parts can jeopardize the safety of your ebike, void your warranty and, in some cases, cause your ebike to not conform with laws pertaining to your bike.



The replacement of original components or installation of third-party accessories or accessories not from Aventon explicitly recommended for your bike model is at your own risk. Using aftermarket accessories or components that have not been tested by Aventon for safety and compatibility may void your warranty, create an unsafe riding condition, damage property or your bike by Aventon, or result in serious injury or death.

Safety Check Before Each Ride

Always check the condition of your bike before you ride in addition to having regular maintenance performed. If you are unsure of how to conduct a complete check of the condition of your bike before every ride, you should consult a certified, reputable bike mechanic for assistance.

Electrical System (Applicable to Pace 350/500, Pace 350/500.2, Sinch, LEVEL/LEVEL.2, Adventure/Adventure.2, Soltera)

The electrical system powers several components on your ebike that control different operating conditions and user preferences. It is critical that you familiarize yourself with all aspects of your ebike's electrical system and check to see if it is working correctly before every ride. The front and rear brake levers contain safety power cutoff switches, which disable the hub motor's assistance when applied, and both levers should be checked for correct operation. The throttle should provide smooth acceleration when gradually applied. If the throttle, brake lever cutoff switches, pedal assistance, or lighting are functioning abnormally, intermittently, or not working, please discontinue the use of your ebike immediately and contact the Aventon Support team for assistance.

Brakes

Ensure that the brakes and their system components are free from damage, properly secured and working correctly. When fully squeezed, both front and rear brake levers should not be touching the handlebar. Take your bike to a certified, reputable bike mechanic to have the brakes repaired if you find a problem.

Tires and Wheels

Your wheels should always spin straight and must be repaired or replaced if they wobble side to side or up and down when spinning. If your wheels become untrue or spokes loosen, which can happen with normal use, we recommend that a certified, reputable bike mechanic performs all wheel tuning and truing operations on your bike from Aventon. Do not attempt to true wheels or tighten spokes unless you have adequate knowledge, tools, and experience. Ensure the tires and inner tubes are in good working condition without any visual damage and have the correct amount of air pressure. Always replace tires and inner tubes with punctures, cuts, or damage before you ride. Tires without the correct amount of air pressure can reduce performance, increase tire and component wear, and make riding your bike unsafe.

Accessories, Straps, and Hardware

Ensure all hardware is secured and all approved accessories are properly attached per the specific component manufacturer's instructions. It is good practice to look over all hardware, straps, and accessories before each ride and if you do discover something wrong or something that you are not sure about, have it checked by a certified, reputable bike mechanic.

Suspension, Handlebar, Grips, and Seat Adjustments

The suspension fork on your ebike will affect the handling of the bike so you must understand how it works before use. The suspension fork should be properly adjusted according to your weight and terrain. Ensure the handlebar and handlebar stem are properly aligned, fitted to the user, and secured to their recommended torque values. Handlebar grips should not move easily on the handlebar end. Loose, worn, or damaged handlebar grips should be replaced before you ride. The seat and seatpost should be properly aligned, fitted to the user, and the seatpost quick release should be properly tightened, fully closed, and secured before riding.

Battery Charged, Secured, and Unplugged

Ensure the battery is adequately charged and operating properly. Ensure the battery charger is unplugged from the outlet, battery, then stored in a safe location before you ride. The battery **MUST** be locked onto the frame battery mount properly before use. Do not operate the electrical system if the battery is removed. Make sure push hard enough while installing the battery into the frame, and hear the "CLICK" sound.

CHARGER SAFETY INFORMATION

- The charger should only be used indoors in a cool, dry, ventilated area, on a flat, stable, hard surface.
- Avoid charger contact with liquids, dirt, debris, or metal objects. DO NOT cover the charger while in use.
- Store and use the charger in a safe place away from children.
- Fully charging the battery before each use can help extend the life of the battery and reduces the chance of over-discharging.
- DO NOT charge the battery with any chargers other than the one originally supplied by Aventon Bikes or a charger designed for use with your specific bike purchased directly from Aventon Bikes.
- The charger works on 110/240V 50/60 Hz standard home AC power outlets and automatically detects and accounts for incoming voltage. DO NOT open the charger or modify voltage input.
- DO NOT yank or pull on the cables of the charger. When unplugging carefully remove both the AC and DC cables by pulling on the plastic plugs directly, and not on the cables.
- The charger is expected to get relatively warmer as it charged. If the charger gets too hot to touch, you notice a strange smell, or any other indicator of overheating, discontinue using the charger and contact Aventon Support.



Charge the battery only with the charger originally supplied with the bike from Aventon Bikes, or a charger purchased directly from Aventon Bikes, designed for use with your specific bike serial number, as approved by Aventon Bikes. Never use an aftermarket charger, which can result in damage, serious injury, or death.



Please take special care in charging your bike from Aventon Bikes in accordance with the procedures and safety information detailed in this manual. Failure to follow proper charging procedures can result in damage to your bike, the charger, or personal property, and/or cause serious injury or death.

General Operating Rules

Notice: Pay special attention to all the general operating rules below before operating your bike from Aventon.

- When riding, obey the same road laws as all other road vehicles as applicable by law in your area.
- For additional information regarding traffic/vehicles laws, contact the road traffic authority in your area.
- Ride predictably, in a straight line, and with the flow of traffic. Never ride against traffic.
- Use correct hand signals to indicate turning.
- Ride defensively; to other road users you may be hard to see.
- Concentrate on the path ahead. Avoid potholes, gravel, wet or oily roads, wet leaves, curbs, train tracks, speed bumps, drain gates, thorns, broken glass, and other obstacles, hazards, and puncture flat risks.
- Cross train tracks at a 90-degree angle or walk your bike across.
- Expect the unexpected such as opening car doors or cars backing out of driveways.
- Be careful at intersections and when preparing to pass other vehicles or cyclists.
- Familiarize yourself with all the features and operations of the bike by Aventon Bikes. Practice and become proficient at shifting gears, applying the brakes, using the pedal assist system, and using the throttle in a controlled setting before riding in riskier conditions.
- Wear proper riding clothes including closed-toe shoes. If you are wearing loose pants, secure the bottom using leg clips or elastic bands to prevent them from being caught in the chain or gears. Do not use items that may restrict your hearing.
- Check your local rules and regulations before carrying cargo.
- When braking, apply the rear brake first, then the front brake. If brakes are not correctly applied, they may lock up and lead to you losing control and/or falling.
- Maintain a comfortable stopping distance from all other objects, riders, and vehicles. Safe braking distances are based on factors such as road surface and light conditions among other variables.

Safety Notes

The following safety notes provide additional information on the safe operation of your bike from Aventon and should be closely reviewed. Failure to review these notes can lead to serious injury or death.

- All users must read and understand this manual before riding their bike from Aventon Bikes. Additional manuals for components used on the bike may also be provided and should be read before installing or using those components.
- Ensure that you comprehend all instructions and safety notes/warnings.
- Ensure the bike fits you properly before your first use. You may lose control or fall if your bike is too big or too small.
- Always wear an approved bicycle helmet whenever riding a bike and ensure that all helmet manufacturer instructions are used for fit and care of your helmet. Failure to wear a helmet when riding may result in serious injury or death.
- Ensure correct setup, tightening, and torquing to recommended torque values is performed on your bike before first using it and check the setup, tightening, and condition of components and hardware regularly.
- It is your responsibility to familiarize yourself with the laws and requirements of operating this product in the area(s) where you ride.
- Ensure the handlebar grips are undamaged and properly installed. Loose or damaged grips can cause you to lose control and fall.
- Do not use this product with standard bike trailers, stands, vehicle racks, or accessories that Aventon has not tested for safety and compatibility and have verified as safe and compatible with the bike.
- Off-road riding requires close attention, specific skills, and presents variable conditions and hazards. Wear appropriate safety gear and do not ride alone in remote areas. Check local rules and regulations about whether off-road ebike riding is allowed.

- **DO NOT ENGAGE IN EXTREME RIDING.** This includes but is not limited to jumps, stunts, or any riding that exceeds your capabilities. Although many articles/advertisements/catalogs depict extreme riding, this is not recommended nor permitted, and you can be seriously injured or killed if you perform extreme riding.
- Bikes and bike parts have strength and integrity limitations, and extreme riding, including but not limited to jumps, stunts, etc., should not be performed as it can damage bike components and/or cause or lead to dangerous riding situations in which you may be seriously injured or killed.
- Failure to perform and confirm proper installation, compatibility, proper operation, or maintenance of any component or accessory can result in serious injury or death.
- After any incident, you must consider your bike unsafe to ride until you consult with a certified, reputable bike mechanic for a comprehensive inspection of all components, functions, and operations of the bike.
- Failure to properly charge, store, or use your battery will void the warranty and may cause a hazardous situation.
- You should check the operation of the brake motor cutoff switches before each ride. The brake system is equipped with an inhibitor that cuts off power to the electric motor whenever the brakes are squeezed. Check proper operation of brake motor cutoff switches before riding.
- Extreme care should be taken when using the pedal assistance sensor and throttle on this product. Ensure you understand and are prepared for the pedal assistance to engage as soon as pedaling is underway.
- Users must understand the operation of the thumb switch throttle and pedal assistance sensors before using the bike and must take care to travel at speeds appropriate for the usage area, riding conditions, and user experience level. Always use the lowest assist level until you are comfortable with the bike and feel confident in controlling the power.
- Any aftermarket changes to your bike from Aventon Bikes not expressly approved by Aventon Bikes could void the warranty and create an unsafe riding experience.
- Because electric bikes are heavier and faster than normal bikes, they require extra caution and care while riding.
- Take extra care while riding in wet conditions including decreasing speed and increasing braking distances. Feet or hands can slip in wet conditions and lead to serious injury or death.
- Do not remove any reflectors.

General Warnings

Like any sport, bicycling involves risk of damage, injury, and death. By choosing to ride a bike, you assume the responsibility for that risk, so you need to know, and practice the rules of safe and responsible riding and the proper use and maintenance of this bike. Proper use and maintenance of your bike reduces risk of damage, injury, and death.

Biking and controlled substances do not mix. Never operate a bike while under the influence of alcohol, drugs, or any substance or condition that could impair motor functions, judgement, or the ability to safely operate a bike or another vehicle.

The Aventure.2 is designed for use by persons 18 years old and older. Riders must have the physical condition, reaction time, and mental capability to ride safely and manage traffic, road conditions, and sudden situations, as well as respect the laws governing electric bike use where they ride, regardless of age. If you have an impairment or disability such as a visual impairment, hearing impairment, physical impairment, cognitive/language impairment, a seizure disorder, or any other physical condition that could impact your ability to safely operate a vehicle, consult your physician before riding any bike.

A Note for Parents and Guardians

As a parent or guardian, you are responsible for the activities and safety of your child. Aventure.2 is not designed for use by children under the age of 18. If you are carrying a passenger in a child safety seat, they should also be wearing a properly fitted and approved helmet.

Caution! Aventon is not reliable for accidents, injuries or product malfunctions that result from any unauthorized changes, modifications or tempering with any part of original specifications.

SAVE THESE INSTRUCTIONS

SPECIFICATIONS

Model Name	Aventure.2
Max. Load Capacity	400lbs. / 181 kg
MAX.Speed	28 MPH
Motor	48V 750W Brushless Hub
Battery	48V 720Wh Li-ion
Range Average Per Charge	Up to 60 Miles
Wheel Size	26 x 4" Front / Rear
Tire Pressure	Inflation to 5-30 PSI
Charger	48V 3.0A
Charging Time	Approx. 6 Hours
Water Resistance	IPX4
Weight	77 Lbs / 35 kg
Light	Front / Rear

* Range Per Charge is measured under the conditions that power is sufficient, with a 75kg load, at 86°F(30°C), 70% humidity, on a level road, in pure electric riding mode. Actual results may vary based on differences in temperature, load, wind speed, road conditions and other factors.

PRODUCT OVERVIEW

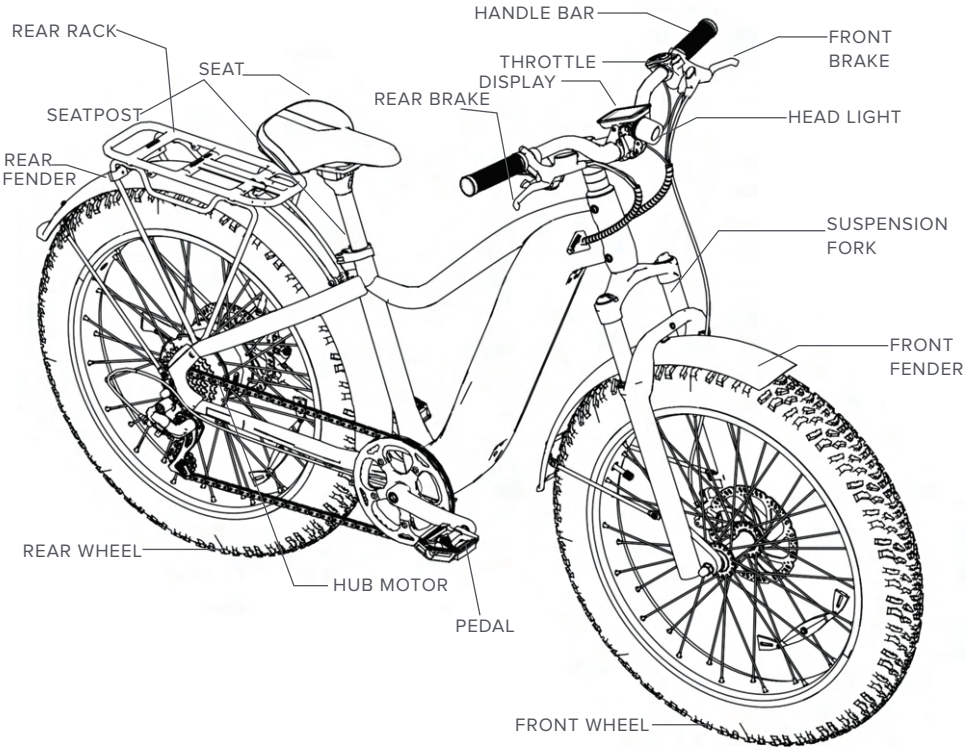

WHAT' S IN THE BOX

- 1*Adventure.2 ebike
- 1*Charger box
- 1*Charger line
- 2*Front/Rear reflector
- 1*Spare derailleur hanger
- 1*Grease
- 1*Hex key
- 1*Wrench
- 1*Owner's manual
- 2*Reflector holder
- 1*Left pedal
- 1*Right pedal
- 1* Rear Rack Bracket

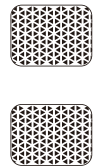
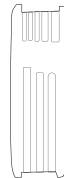
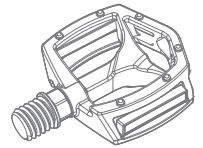
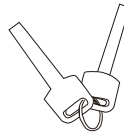
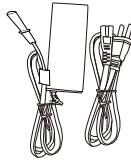

INSTALLATION INSTRUCTION

NOTICE: The following steps are only a general guide to assist in the assembly of your ebike and are not a complete or comprehensive manual of all aspects of assembly, maintenance, and repair. Consult a certified, reputable bike mechanic to assist with assembly, repair, and maintenance of your ebike.

Step 1: Unpack the bike.

Open the bike box. With the help of another person capable of safely lifting a heavy object, remove the ebike from the bike box. Carefully remove the packaging material protecting the bike frame and components, as well as remove the small boxes attached to the fork. These are your charger and accessories. Please recycle packaging materials especially cardboard and foam whenever possible.

Step 2: Preparing for handlebar installation.

Remove the stem rubber cover, loosen the bolt using 5mm hex key, and discard the plastic white protective guard.

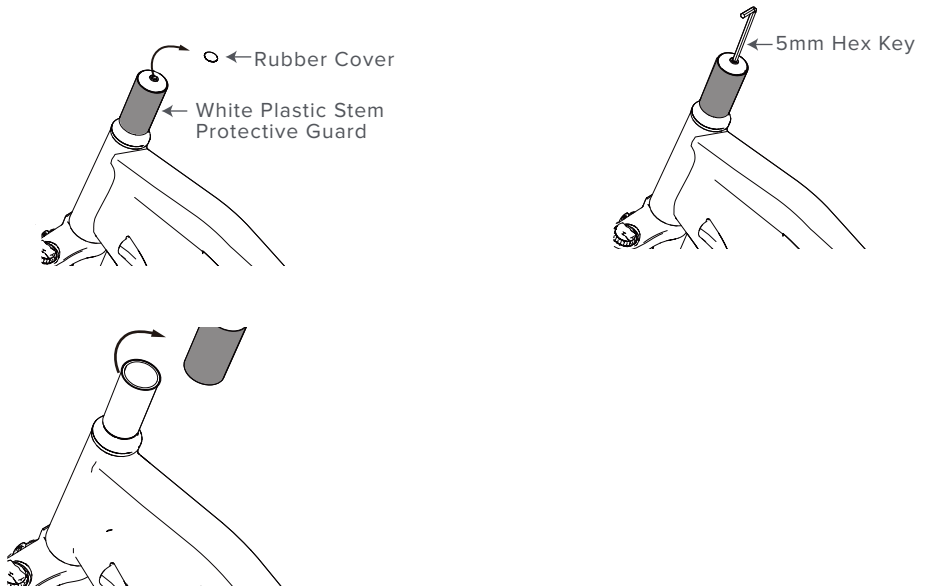

Step3: Handlebar Installation.

Loosen the 2 screws in the stem, place stem onto the head tube with the display facing upwards, replace the top cap and use 5mm hex key to securely tighten the handlebar. Reinsert the rubber cover back into the top cap.



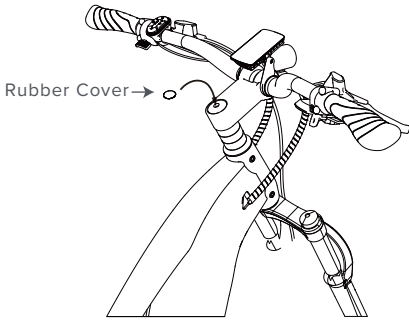

Step4: Front wheel installation.

A. Take out front wheel remove paper protective guard.

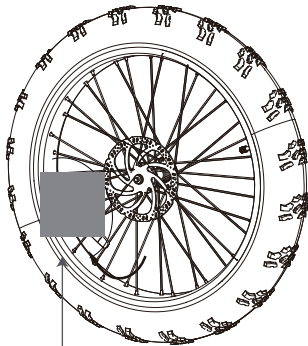

C. Loosen the front axle nuts and place the front suspension fork onto the front Wheel. Ensure the brake rotor is between the brake pads of the brake caliper.

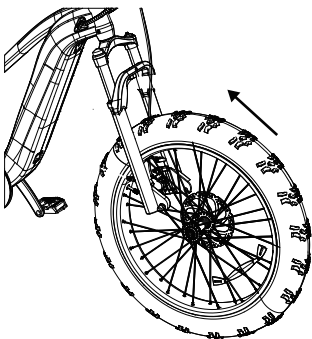

B. Remove fork protective cover and take out plastic insert from front wheel brake caliper.

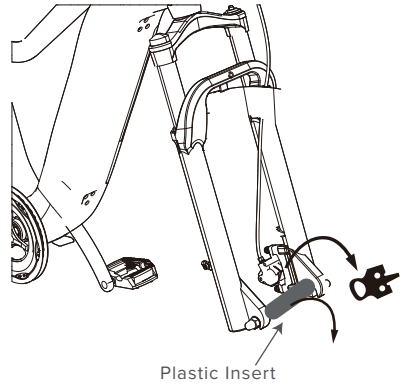

D. Use 15mm open wrench to tighten front axle nut, recommended torque value at 25-30Nm.

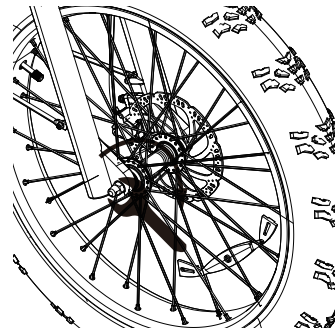

Caution: Never touch the brake rotor, especially when the wheel and/or bike is in motion, or serious injury could occur. Hand oils can cause squeaking and decrease brake performance

WARNING: An improperly secured front wheel and/or handlebar stem can cause loss of control, accidents, serious injury, or death. Check that the front wheel and handlebar stem are properly secured to the bike during assembly and before each ride.

Step 5: Front fender installation.

A. Use 4mm hex key to loosen front fork screws. (3 pcs)

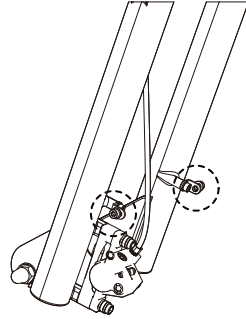
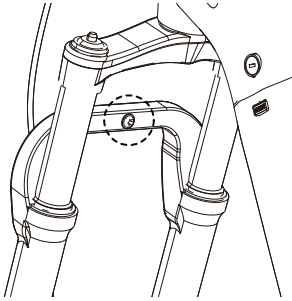

B. Align front fender to the screw holes, use 4mm hex key to tighten front fork screws. (3 pcs)

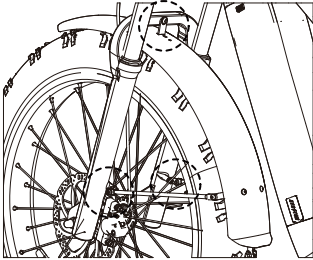

Step 6: Put down kickstand to support the ebike.

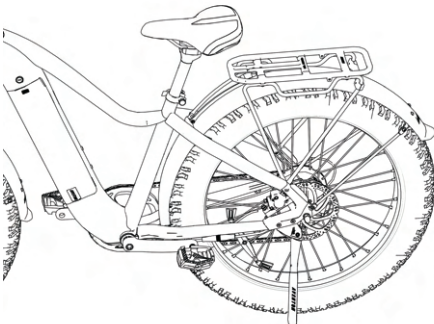

Step 7: Adjusting the display and handlebar.

A. Sit on the saddle, adjust handlebar to the desired position.

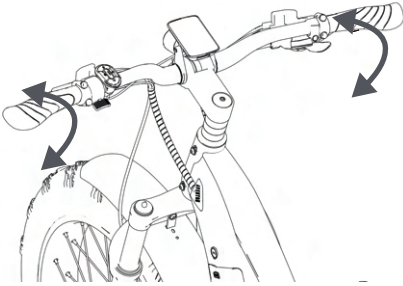

B. Stand in front of the bike and clamp front wheel between both legs, verify the handle bars are straight and in line with the front wheel. Make sure the pinch bolts are tight and you can not turn the stem freely from the front wheel.

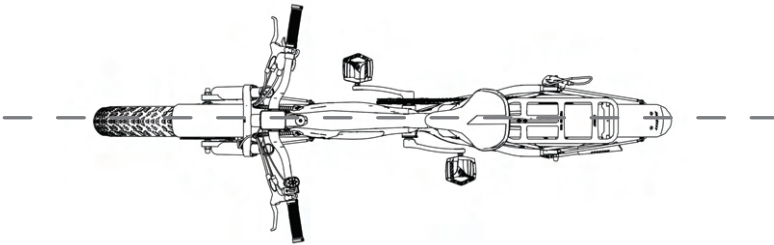

C. tighten the screws which secure it to the handlebar with 4mm hex key.

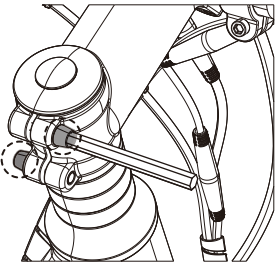

D. Adjust display to the desired position, tighten the screws with 2mm hex key.

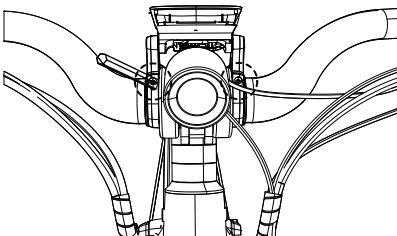

E. Adjust the head light to desired position, tighten the screw with a 4mm hex key. Loosen the circled screw if you want to adjust the display's angle.

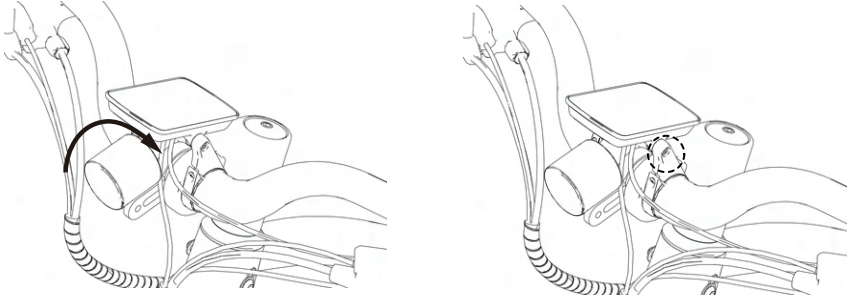

Step 8: Install the rear rack.

A. Pull the front stays forward to the frame and find the holes for screws on the frame.

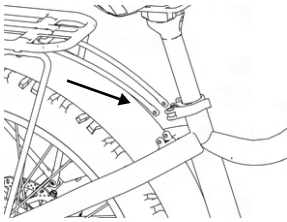

B. Push the attached M5 screw through to fix the front stays in place. Put on the attached M5 washer and nut, then tighten the screw with NO.8 allen wrench.

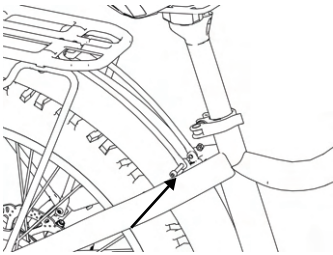

C. Remove the screws on the bracket. Install the bracket in between the rear stays, and fix it in place with attached M5 washers and screws.

ATTENTION: Lift the bracket up while installing to avoid touching the rear fender.

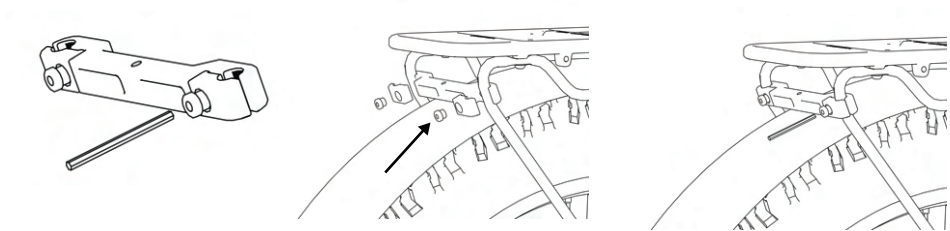

D. Adjust the rack after all the process is done. Make sure the rack aligns with the whole bike.

ATTENTION: Double check all the screws are tightened and make sure the rack is leaning forward for 1-3 degrees. If the angle is more than 3 degrees, then loosen the circled screws and adjust the rack's angle. Then tighten the screws to make sure the rack has the correct angle.

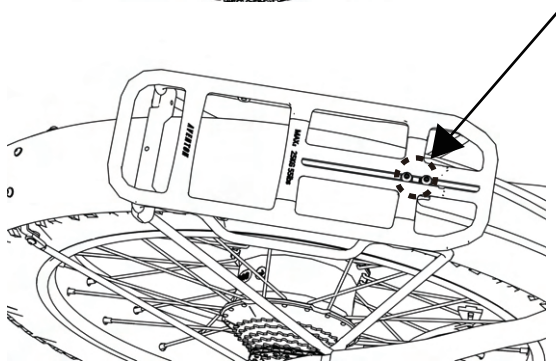
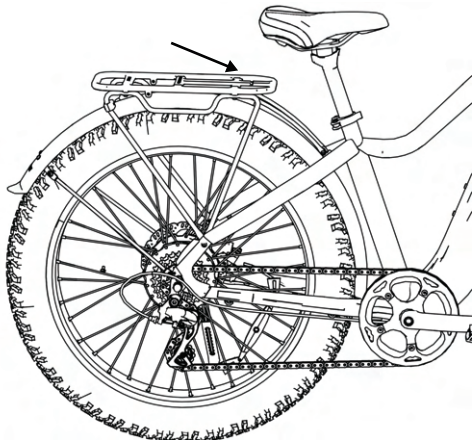

E. Check the bottom screws and make sure they are fixed.

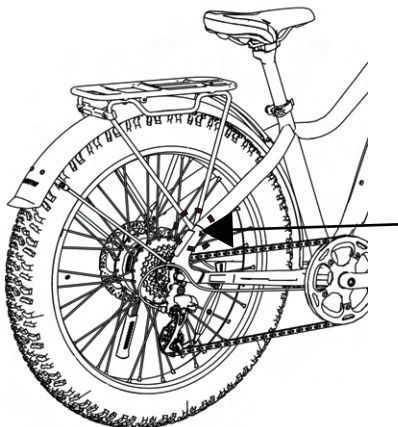

Step 9: Pedal installation.

Use wrench to install the pedals. Locate the pedal with a smooth pedal axle exterior and an "R" sticker label (1, below), which indicates it is the right pedal. The right pedal goes on the crank on the right side of the bike (which has the drivetrain gears and is the same as a rider's right side when riding).

1. The right pedal (pedal with "R" sticker label) is threaded so that it is tightened by turning clockwise.

Apply grease to the thread and carefully thread the right pedal onto the crank on the right side of the bike slowly and by hand. Do not cross thread or damage the threads.

2. The left pedal (pedal with "L" sticker label) is reverse-threaded and tightens counterclockwise.

Apply grease and carefully thread the pedal onto the left crank by hand slowly.

Do not cross thread or damage the threads.

Torque each pedal to 35 Nm.

Identifying marks Right pedal (has a "R" sticker) tightens clockwise, Left pedal (has a "L" sticker) tightens counterclockwise

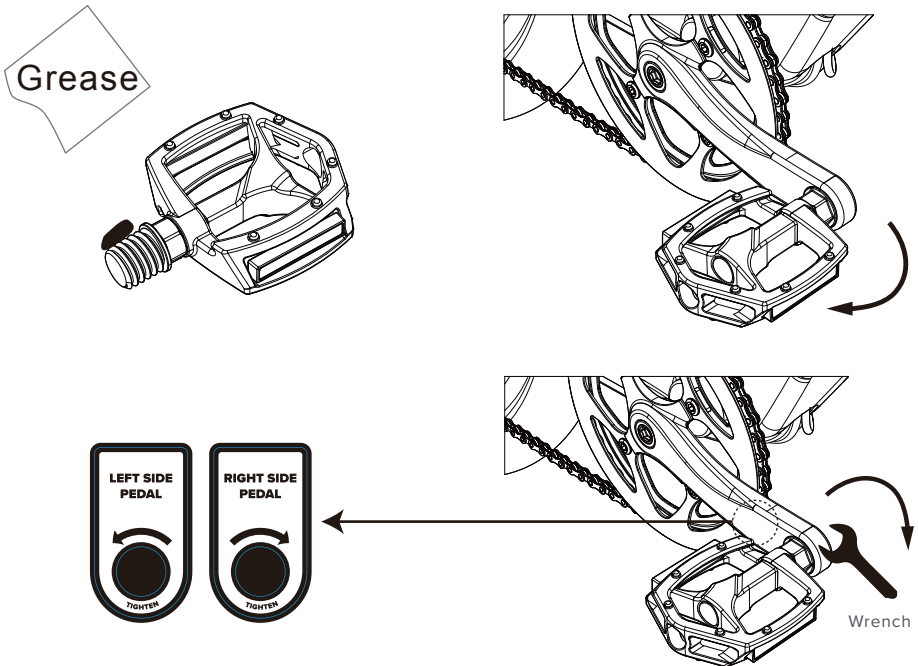

Step 10: Inflate tires.

Check that the tire beads and tires are evenly seated on the rims. Use a pump with a Schrader valve and pressure gauge to inflate each tire to the recommended pressure indicated on the tire, min of 5 PSI , max of 30 PSI. Do not overinflated or underinflate tires.

Step 11: Install saddle.

Open seatpost clamp lever, adjust the seatpost to a comfortable height, while ensuring the seatpost is inserted past the minimum insertion point, as indicated on the seat post. Close the seatpost clamp lever.

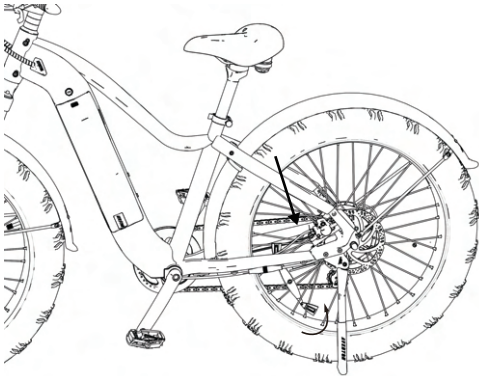

Step 12: Adjusting the seat position and angle

To change the angle and horizontal position of the seat:

A. Use a 5mm Allen wrench to loosen the seat adjustment bolt on the clamp positioned directly underneath the seat, above the rear wheel. Do not completely remove the bolt.

B. Move the seat backward or forward and tilt to adjust the angle. The seat position horizontal to flat ground is desirable for most riders. Do not exceed the limit markings on the seat rail, which show the minimum and maximum horizontal movement allowed.

C. While holding the seat in the desired position, use a 5mm allen key to tighten the seat angle adjustment bolt securely to the recommended torque value(8Nm).

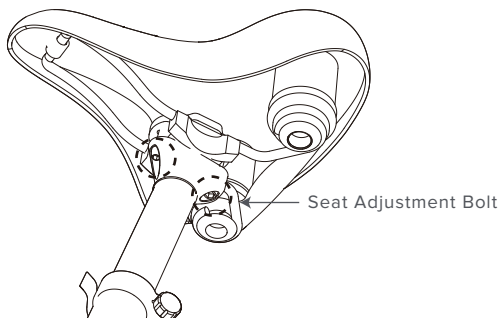

Step 13: Powering on the display.

A. Press the power button for about 3 seconds
To turn on the display.

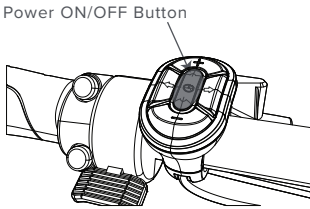

B. For more details, please refer to the display operating manual.

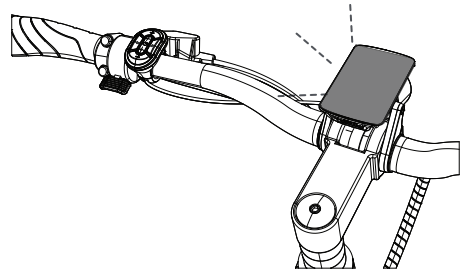

BATTERY CHARGING

Charging procedure

Follow these steps for charging your ebike battery from Aventon Bikes:

1. **Ensure the battery is off.**
2. **Remove the rubber cover on the charging port.**
3. **Plug the charger into the battery's charging port, BEFORE PLUGGING CHARGER INTO POWER OUTLET.** With the battery on or off the bike, place the charger in a flat, secure place, and connect the DC output plug from the charger (round barrel connector) to the charging port on the side of the battery.
4. **Plug the charger into a power outlet:** Connect the charger input plug (110/240-volt plug) to the power outlet. Charging should initiate and will be indicated by the LED charge status light on the charger illuminating as red light.
5. Unplug the charger from the outlet, then the charging port: Once fully charged, indicated by one charging indicator light turning green, unplug the charger from the wall outlet first and then remove the charger outlet plug from the battery charging port.
6. **Battery indicator light:** Blue: 66%-100%. Green: 33%-66%. Red: 0%-33%.

Always charge your battery in temperature between 32 °F – 104 °F (0 °C – 40 °C) and ensure the battery and charger are not damaged before initiating charge. If you notice anything unusual while charging, please discontinue charging and using the bike and contact Aventon Bikes Product Support for help.

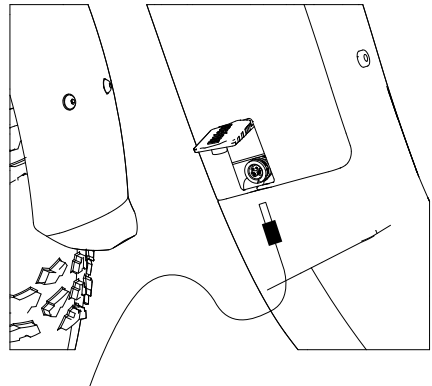
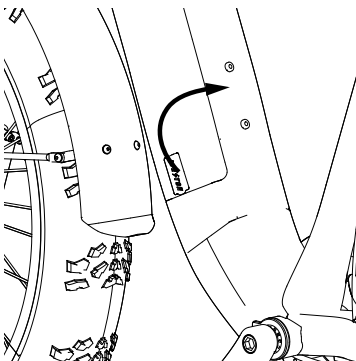

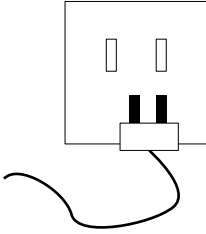

BATTERY CHARGING INFORMATION AND BEST PRACTICES

- Check the charger, charger cables, and battery for damage before beginning each charge.
- Be sure to charge in an area where it is clear and safe from any potential damage or tripping situations can occur while it is charging. Always charge your battery in temperature between 32 °F - 104°F (0°C-40°C).
- The battery can be charged on or off the bike. To remove the battery, turn the key to the unlocked position, and take the battery out.
- The battery should be recharged after each use, so it is ready to go the full range for your next ride. There is no memory effect, so charging the battery after short ride will not cause damage.
- Charging the battery normally takes 3-7 hours.
- The indicator light on the charger will show red light while the battery charges. When charging is complete, the indicator light will turn green. Ensure the light faces upward when charging.
- Remove the charger from the battery within one hour of the green light indicating a complete charge. The charger is designed to automatically stop charging when the battery is full, but unnecessary wear of the charging components could occur if the charger is left attached to the battery and a power source for longer than 12 hours.
- Never charge a battery for more than 12 hours at a time.
- DO NOT leave a charging battery unattended.
- **For turning on the bike:** Quick press the button on the battery, make sure the light comes on. Then hold the button next to the display to turn on the bike.
- **For turning off the bike:** Hold the button next to the display. Then hold the button on the battery for around 3 seconds to turn off the bike.



Failure to follow Battery Charging Information could result in unnecessary wear to the charging components, battery, and or charger, and could lead to an underperforming or non-functional battery and replacement will not be covered under warranty.

REMOVING THE BATTERY

To remove the battery from the bike, insert the key and turn to the unlocked position. When the battery is completely locked, you can feel resistant while turning the key.

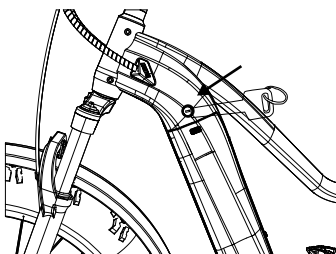



Use caution to avoid damage to battery connector terminals, which are exposed when the battery is unlocked and removed from the frame of the bike. In the case of damage to the terminals or battery mounts, please discontinue use and contact Aventon Support immediately.

WHEN INSTALLING THE BATTERY ON THE BIKE

- Ensure the battery is turned off.
- DO NOT force the battery into the tray; slowly align and gently push the battery down into the tray. Then push the battery in (make sure you push hard enough) and hear the “CLICK” sound. Slightly turn the key to feel if there’s resistance from the key. If you can feel the resistance, then the battery is completely locked.
- Make sure there is no spaced between battery and tray, confirm battery.
- Ensure the battery has been properly secured to the bike before each use by carefully pulling outwards on the battery with both hands once locked.

STORAGE INSTRUCTION

If storing your bike from Aventon Bikes for longer than 2 weeks at a time, follow the instructions below to maintain the health and longevity of your battery.

- Charge(or discharge) the battery to approximately 75% charged.
- DO NOT leave the battery attached to the bike frame. Remove it from the bike during long-term storage.
- Store the battery in a dry, climate controlled, indoor location between 32 °F - 104°F (0°C-40°C).
- Check the battery every month, and if necessary, use the Aventon Bikes charger to charge the battery to 75% charged.
- If stored for a long time, keep the battery cool and dry, and charge the battery for 2 hours every other 3 months.



Please follow the above instructions for storing your bike and battery from Aventon Bikes. Failure to follow proper battery storage procedures can result in a non-functional battery. Replacement will not be covered under warranty.



If the battery is physically damaged, non-functional, performing abnormally, or was dropped or involved in a crash, with or without obvious signs of damage, please discontinue use and charging and contact Aventon Bikes immediately.





DO NOT cover up the charger while it is charging. The charger air cools and needs to be on a hard, flat surface in an open space. Use the charger with the indicator lights facing upward. DO NOT use with the charger inverted, which can inhibit cooling and reduce charger lifespan.



DO NOT open the battery housing, which will void the warranty and can result in damage to the battery, property or cause serious injury and/or death.

AVENTURE.2 QUICK START GUIDE



GETTING STARTED

Tap the power button on the battery to turn on the battery. The power button will light up. (Blue light: Full; Green light: Half; Red light: Near empty). Then long press the  button on the display control pad to turn on the bike. To turn off, press and hold the  button for 3 seconds, then press and hold the power button on the battery for 3 seconds. The power button light will turn off after long press.

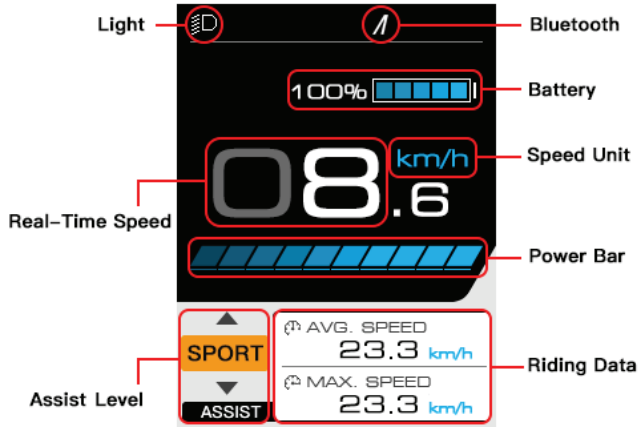
Home Page



DISPLAY CONTROL PAD

1. You can press the  button while you want to turn left. The left side tail light will light up. Press the  button while you want to turn right. The right tail light will light up.
2. Long press "+" to turn on the front light and rear light while riding in a dark environment.



ASSIST LEVEL

Use '+'/'-' to switch. Long press '-' is pedestrian mode.

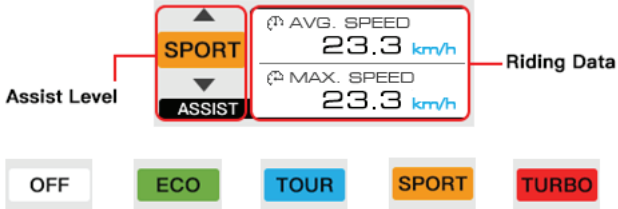

RIDING DATA PAGES



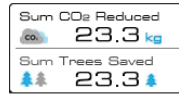
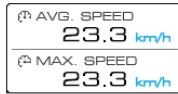
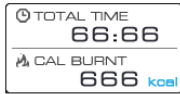
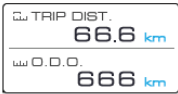



Click  to switch.



Light



Long press "+" to switch light.

TRIP A/B PAGES

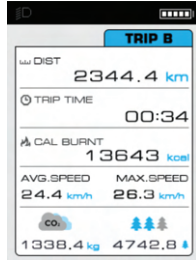
1. Double press  /  to enter the Trip A page, and press  /  to switch to the Trip B page.
2. Double press  /  to exit the Trip A/B page.



MAIN MENU

1. Long press '+' & '-' to enter the main menu.
2. Use '+' / '-' to navigate to the 'Set Unit' line and press  to change unit.
3. Select 'Clear Trip Data' and other items using the same method.
4. In each page, use '+' / '-' to adjust the parameters.
5. Press  to exit menu.

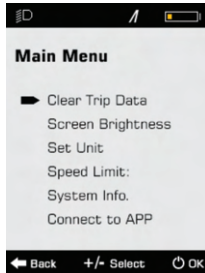

CONNECT TO AVENTON APP

1. Long press '+' & '-' to enter the main menu.
2. Use '+' / '-' to navigate to the 'Connect to APP' line and press .
3. Scan the QR-Code displayed on the screen with Avention APP to access more functions.



OPERATION INSTRUCTION

NOTICE: DO NOT perform any of the steps in the Operation section of this manual until you have read this entire manual, since there are important details related to safety in the following sections.



Read and understand all sections of this entire manual before operating the bike for the first time. There are important safety warnings throughout the manual that must be followed] to prevent dangerous situations, accidents, damage to the bike, damage to property, injury, or death.



Users must follow the instructions and warnings contained in this manual for safety. DO NOT attempt to operate your bike from Aventon Bikes until you have adequate knowledge of its control and operation. Damage caused by failing to follow instructions is not covered under warranty and could result in serious injury or death. Contact Aventon Bikes if you have any questions about assembly or operation.



Users must become accustomed to the bike's power control system before operating. The pedal assistance feature is also a powerful option and users should fully research and understand how to operate it before first use. Not taking the time and care to familiarize yourself and practice the operation of the power system on your bike from Aventon Bikes can lead to damage, serious injury, or death.

DRIVING RANGE

The range of your bike from Aventon Bikes is the distance the bike will travel on a single full charge of the onboard battery. The range values in this manual are estimates based on expected usage characteristics of bikes by Aventon Bikes. Some of the factors that affect range include changes in elevation, speed, payload, acceleration, number of starts and stops, ambient air temperatures, tire pressure, and terrain.

We suggest that you select a lower assistance level when you first get your bike from Aventon Bikes to get to know your bike and travel routes. Once you become familiar with the range requirements of your travel routes and the capabilities of your bike, you can then adjust your riding characteristics if you so desire. The following table provides general range estimates based on various factors. This table is meant to help owners understand the factors that can contribute to decreased range, but Aventon Bikes makes no claims to the range that individual users might experience in a particular use case.

Expected Range	Operating Condition(s)
32 km (20 mi)	Hilly Terrain Heavy Payload Windy High Pedal Assist Level/ High Throttle Use Light Pedalling
48 km (30 mi)	Flat Terrain Normal Payload Not Windy Medium Pedal Assist Level/ Moderate Throttle Use Light Pedalling
64 km (40 mi)	Flat Terrain Normal Payload Not Windy Low Pedal Assist Level/ Minimal Throttle Use Moderate to Heavy Pedalling

Parking, Storage, and Transport

Please follow these basic parking, storage, and transport tips to ensure your bike is well cared for on and off the road.

- When pushing or carrying the bike manually, turn off the power to avoid accidental acceleration from the motor.
- Turn the power and any lights off to conserve battery.
- Ensure the battery is locked to the frame in the off position or use the key to remove the battery and bring it with you for security or storing in a temperature-controlled location.
- Park indoors when possible. If you must park outdoors in rain or wet conditions, leave your ebike outside for only a few hours and then park it in a dry location as soon as possible to allow all of the systems to dry out. As with a regular bike, an ebike used in wet conditions needs more frequent maintenance to prevent rust, corrosion, etc. and to ensure all systems are working safely.
- In public places, your bike from Aventon Bikes must be parked in accordance with local rules and regulations.

- Locking up your bike is recommended to ensure your bike is secure and the chance of theft is reduced. Aventon Bikes makes no claims or recommendations on the proper lock hardware or procedures to secure your bike, but we do recommend you take appropriate precautions to keep your bike safe from theft.
- Do not park, store, or transport your bike from Aventon Bikes on a vehicle rack not designed for the bike's size and weight.
- Use a vehicle rack compatible with the width of tires used on your bike. Some racks may not accommodate all tire widths.
- When carrying your bike on a vehicle rack for transport, unlock and remove the battery. This will reduce the weight of the bike, make lifting and loading easier, and allow you to protect the battery by transporting it in the cab of a vehicle.
- Avoid transporting bikes from Aventon Bikes on a vehicle rack during rain, as this may cause water damage to the electrical components.

USER MAINTENANCE AND SERVICE INSTRUCTIONS

Basic Bike Care



If you do not have the experience, skill, and tools to complete maintenance and adjustment of your bike, Aventon Bikes strongly recommends having a certified, reputable bike mechanic maintain, tune, and ensure the bike is safe to ride.

Recommended Service Intervals

Regular inspection and maintenance are key to ensure Aventon Bikes function as intended, and to reduce wear and tear on their systems. Recommended service intervals are meant to be used as guidelines. Real world wear and tear, and the need for service, will vary with conditions of use. We generally recommend inspections, service, and necessary replacements be performed at the time or mileage interval that comes first in the following table.

Interval	Inspect	Service	Replace
Weekly, 160-321 km (100- 200 mi)	<ul style="list-style-type: none"> - Check hardware for proper torque. - Check drivetrain for proper alignment and function (including the chain, freewheel, chainring, and derailleur). - Check wheel trueness and for quiet wheel operation on (without spoke noise) - Check condition of the frame for any damage. 	<ul style="list-style-type: none"> - Clean frame by wiping frame down with damp cloth. - Use barrel adjuster(s) to tension derailleur/brake cables if needed. 	<ul style="list-style-type: none"> - Replace any components confirmed by Aventon Bikes Product Support or a certified reputable bike mechanic to be damaged beyond repair or broken.
Monthly, 402-1207 km (250- 750 mi)	<ul style="list-style-type: none"> - Check brake pad alignment, brake cable tension. - Check bike is shifting properly, proper derailleur cable tension. - Check chain stretch. - Check brake and shifter cables for corrosion or fraying. - Check spoke tension. - Check accessory mounting (rack mounting bolts, fender hardware, and alignment). 	<ul style="list-style-type: none"> - Clean and lubricate drivetrain. - Check crankset and pedal torque. - Clean brake and shift cables. - True and tension wheels if any loose spokes are discovered. 	<ul style="list-style-type: none"> - Replace brake and shift cables if necessary. - Replace brake pads if necessary.
Every 6 Months, 1207-2011 km (750- 1250 mi)	<ul style="list-style-type: none"> - Inspect drivetrain (chain, chainring, freewheel, and derailleur). - Inspect all cables and housings. 	<ul style="list-style-type: none"> - Standard tune-up by certified, reputable bike mechanic is recommended. - Grease bottom bracket. 	<ul style="list-style-type: none"> - Replace brake pads. - Replace tires if necessary. - Replace cables and housings if necessary.

Pre-Ride Safety Checklist

Notice: Before every ride, and after every 25-45 miles (40-72 km), we advise following the pre-ride safety checklist.

Safety Check	Basic Steps
1. Brakes	<p>Ensure front and rear brakes work properly.</p> <p>Check brake pads for wear and ensure they are not overworn.</p> <p>Ensure brake pads are correctly positioned in relation to the rims.</p> <p>Ensure brake cables are lubricated, correctly adjusted, and display no obvious wear.</p> <p>Ensure brake levers are lubricated and tightly secured to the handlebar.</p> <p>Test that the brake levers are firm and that the brake, motor cutoff functions, and the brake light are functioning properly.</p>
2. Wheels and Tires	<p>Ensure tires are inflated within the recommended limits posted on the tire sidewalls and hold air.</p> <p>Ensure tires have good tread, have no bulges or excessive wear, and are free from any other damage.</p> <p>Ensure rims run true and have no obvious wobbles, dents, or kinks.</p> <p>Ensure all wheel spokes are tight and not broken.</p> <p>Check axle nuts and front wheel quick release to ensure they are tight. Ensure the locking lever on the quick release skewer is correctly tensioned, fully closed, and secured.</p>
3. Steering	<p>Ensure the handlebar and stem are correctly adjusted, tightened, and allow proper steering.</p> <p>Perform a handlebar twist test (as step 13 shows) to ensure the stem clamp bolt's security.</p> <p>Ensure the handlebar is set correctly in relation to the fork and the direction of travel.</p>
4. Chain	<p>Ensure the chain is clean, oiled, and runs smoothly.</p> <p>Extra care is required in wet, salty/otherwise corrosive, or dusty conditions.</p>
5. Bearings	<p>Ensure all bearings are lubricated, run freely, and display no excess movement, grinding, or rattling.</p> <p>Check headset, wheel bearings, pedal bearings, and bottom bracket bearings.</p>
6. Cranks and Pedals	<p>Ensure pedals are securely tightened to the cranks.</p> <p>Ensure the cranks are securely tightened and are not bent.</p>
7. Deraillleur and Mechanical Cables	<p>Check that the deraillleur is adjusted and functioning properly.</p> <p>Ensure shifter and brake levers are attached to the handlebar securely.</p> <p>Ensure all shifter and brake cables are properly lubricated.</p>
8. Frame, Fork, and Seat	<p>Check that the frame and fork are not bent or broken.</p> <p>If either frame or fork are bent or broken, they should be replaced.</p> <p>Check that the seat is adjusted properly, and seatpost quick release lever is securely tightened.</p>
9. Motor Drive Assembly and Throttle	<p>Ensure hub motor is spinning smoothly and motor bearings are in good working order.</p> <p>Ensure all power cables running to hub motor are secured and undamaged.</p> <p>Make sure the hub motor axle bolts are secured and the torque arm, torque arm bolt, and torque washers are in place.</p>
10. Battery	<p>Ensure battery is charged before use.</p> <p>Ensure there is no damage to battery.</p> <p>Lock battery to frame and ensure that it is secured.</p> <p>Charge and store bike and battery in a dry location, between 32 °F - 104°F (0°C-40°C).</p> <p>Let bike dry completely before using again.</p>
11. Electrical Cables	<p>Look over connectors to make sure they are fully seated and free from debris or moisture.</p> <p>Check cables and cable housing for obvious signs of damage.</p> <p>Ensure headlight, taillight, and brake light are functioning, adjusted properly, and unobstructed.</p>
12. Accessories	<p>Ensure all reflectors are properly fitted and not obscured.</p> <p>Ensure all other fittings on bike are properly secured and functioning.</p> <p>Inspect helmet and other safety gear for signs of damage.</p> <p>Ensure rider is wearing a helmet and other required riding safety gear.</p> <p>Ensure mounting hardware is properly secured if fitted with a front rack, rear rack, basket, etc.</p> <p>Ensure the taillight and taillight power wire are properly secured if fitted with rear rack.</p> <p>Ensure the fender mounting hardware is properly secured if fitted with fenders.</p> <p>Ensure there are no cracks or holes in fenders.</p> <p>If installed, ensure the optional rear wheel lock is secured in the unlocked position and the key is removed before every ride.</p>



Your cables, spokes, and chain will stretch after an initial break-in period of 50-100 mi (80-160 km), and bolted connections can loosen. Always have a certified, reputable bike mechanic perform a tune-up on your Aventure.2 after your initial break-in period of 50-100 mi (80-160 km) (depending on riding conditions such as total weight, riding characteristics, and terrain). Regular inspections and tune-ups are particularly important for ensuring that your bike remains safe and fun to ride.

Tire Information

Aventure.2 uses 26" x 4.0" rubber tires with inner tubes. The tires are designed for durability and safety for regular cycling activities and to be checked before each use for proper inflation and condition. Proper inflation, care, and timely replacement will help to ensure that your bike's operational characteristics will be maintained, and unsafe conditions avoided.

Aventon Bikes recommends 5-30 PSI for the stock tires on Aventure.2. Always stay within the manufacturer's recommended air pressure range as listed on the tire sidewall.



It is critically important that proper air pressure is always maintained in pneumatic tires. Do not underinflate or overinflate your tires. Low pressure may result in loss of control, and overinflated tires may burst. Failure to always maintain the air pressure rating indicated on pneumatic tires may result in tire and/or wheel failure.



Inflate your tires from a regulated air source with an available pressure gauge. Inflating your tires from an unregulated air source could overinflate them, resulting in a burst tire. Even tires equipped with built-in flat-preventative tire liners, like those that come with bikes by Aventon Bikes, can and do get flats from punctures, pinches, impact, and other causes. When tire wear becomes evident or a flat tire is discovered, you must replace the tires and/or tubes before operating the bike or injury to operators and/or damage to your bike could occur.



When changing a tire or tube, ensure that all air pressure has been removed from the inner tube prior to removing the tire from the rim. Failure to remove all air pressure from the inner tube could result in serious injury.



Using aftermarket tires or inner tubes, not provided by Aventon Bikes may void your warranty, create an unsafe riding condition, or damage to your bike by Aventon Bikes. If required by law, ensure replacement aftermarket tires have sufficient reflective sidewall striping. For more information on tire or tube replacement procedures, or questions about tire inflation, contact Aventon Bikes Product Support.

Support link: <https://support.aventon.com/contact-us> or Call: 1-866-300-3311

Derailleur

On the right side of handlebar, next to the brake lever, you can see two levers with 8-1 gears. Those are derailleur levers. By pressing those levers, you can make the chain move to different gears to change your riding experience. Derailleur requires regular maintenance.

TROUBLE SHOOTING

	Symptoms	Possible Causes	Most Common Solutions
1	The bike does not work	<ol style="list-style-type: none"> 1. Insufficient battery power 2. Faulty connections 3. Battery not fully seated in tray 4. Improper turn on sequence 5. Brakes are applied 	<ol style="list-style-type: none"> 1. Charge the battery 2. Clean and repair connectors 3. Install battery correctly 4. Turn on bike with proper sequence 5. Disengage brakes
2	Irregular acceleration and/or reduced top speed	<ol style="list-style-type: none"> 1. Insufficient battery power 2. Loose or damaged throttle 3. Misaligned or damaged magnet ring 	<ol style="list-style-type: none"> 1. Charge or replace battery 2. Replace throttle 3. Align or replace magnet ring
3	The motor does not respond when the bike is powered on	<ol style="list-style-type: none"> 1. Loose wiring 2. Loose or damaged throttle 3. Loose or damaged motor plug wire 4. Damaged motor 	<ol style="list-style-type: none"> 1. Repair and or reconnect 2. Tighten or replace 3. Secure or replace 4. Repair or replace
4	Reduced range	<ol style="list-style-type: none"> 1. Low tire pressure 2. Low or faulty battery 3. Driving with too many hills, headwind, braking, and/or excessive load 4. Battery discharged for long period of time without regular charges, aged, damaged. 5. Brakes rubbing 	<ol style="list-style-type: none"> 1. Adjust tire pressure 2. Check connections or charge battery 3. Assist with pedals or adjust route 4. Contact Product Support if range decline persists. 5. Adjust the brakes
5	The battery will not charge	<ol style="list-style-type: none"> 1. Charger not well connected 2. Charger damaged 3. Battery damaged 4. Wiring damaged 	<ol style="list-style-type: none"> 1. Adjust the connections 2. Replace 3. Replace 4. Repair or replace
6	Wheel or motor makes strange noises	<ol style="list-style-type: none"> 1. Loose or damaged wheel spokes or rim 2. Loose or damaged motor wiring 	<ol style="list-style-type: none"> 1. Tighten, repair, or replace 2. Reconnect or replace motor.

Error Detection

Your bike from Aventon Bikes is equipped with an error detection system integrated into the display and controller. In the case of an electronic control system fault an error code should display. The following error codes are the most common and can aid in troubleshooting. If your bike has an error code displayed at any time it is recommended that you cease operation and contact Aventon Bikes immediately.

Error Code	Definition
21	Abnormal Current
22	Throttle Fault
23	Motor Phase Fault
24	Motor Hall Fault
25	Brake Switch Fault or Brake Applied While Turning On
26	Overheat Protection
27	Motor Lock Protection
29	Over Voltage Protection
30	Communication Fault

Additional Information on Wear

Components of Adventure.2 are subject to higher wear when compared to bikes without power assistance. This is because Adventure.2 can travel at higher average speeds than regular bicycles and has a greater weight. Higher wear is not a defect in the product and is not subject to warranty. Typical components affected are the tires, brake pads and rotors, suspension forks, spokes, wheels, and the battery.



When the useful life of a component is surpassed it can cause unexpected loss of function. This can result in serious injuries or even death. Therefore, pay attention to wear characteristics such as cracks, scratches, or changes in the color or operation of components which could indicate useful life has been exceeded. Worn components should be replaced immediately. If you are unfamiliar with regular maintenance, a certified, reputable bike mechanic should be consulted.

LIMITED WARRANTY

Your bike's warranty and other binding legal terms (e.g., terms of purchase, etc.) are subject to change at any time. To view your terms of purchase and know current warranty, please go to <https://www.aventon.com/pages/warranty>

Warranty Info

All Aventon ebikes, and their individual covered components (as defined herein), are protected against all manufacturing defects in material or workmanship for one (1) year after the date of a qualifying purchase (the "Warranty Period"). This Limited Warranty is only applicable to United States ebike purchases (purchases in Canada and the European Union shall be subject to their respective warranty terms) and in accordance with the following terms:

- Only the original owner of an ebike purchased from Aventon online or physical storefront is covered by this Limited Warranty. The Warranty Period begins upon your receipt of the ebike and shall end immediately upon the earlier of the end of the Warranty Period or any sale or transfer of the ebike to another person, and under no circumstances shall the Limited Warranty apply to any subsequent owner or other transferee of the ebike.
- The Limited Warranty is expressly limited to the replacement of a defective lithium ion battery (the "battery"), frame, forks, stem, handlebar, headset, seat post, saddle, brakes, lights, bottom bracket, crank set, pedals, rims, wheel hub, freewheel, cassette, derailleur, shifter, motor, throttle, controller, wiring harness, LCD display, kickstand, reflectors and hardware (each a "covered component").
- The Covered Components are warranted to be free of defects in materials and/or workmanship during the Warranty Period.

This Limited Warranty Does Not Cover:

- Normal wear and tear of any Covered Component.
- Consumables or normal wear and tear parts (including without limitation tires, tubes, brake pads, cables and housing, grips, chain and spokes).
- Any damage or defects to Covered Components resulting from failure to follow instructions in the ebike owner's manual, acts of God, accident, misuse, neglect, abuse, commercial use, alterations, modification, improper assembly, installation of parts or accessories not originally intended or compatible with the ebike as sold, operator error, water damage, extreme riding, stunt riding, or improper follow-up maintenance.
- For the avoidance of doubt, Aventon will not be liable and/or responsible for any damage, failure or loss caused by any unauthorized service or use of unauthorized parts.
- The Battery is not warranted from damage resulting from power surges, use of an improper charger, improper maintenance or other such misuse, normal wear or water damage.

Determining whether damage or defect to an ebike or covered component is protected by this limited warranty shall be in the sole discretion of Aventon.

Shipping Damage:

Damage to a covered components during shipping is not covered by this Limited Warranty, but Aventon will replace such damaged covered components if you:

- Notify Aventon of a covered components damaged in the shipping process within thirty (30) days of your receipt of the ebike;
- Provide Aventon with a dated picture of the damaged covered components;
- Return all original packaging and paperwork included with the ebike
- Take note of any immediately recognizable damage on the shipper' s Bill of Lading prior to signing off on the shipment.

Shipping damage claims are very time sensitive and it is your responsibility to immediately inspect the ebike for damage upon receipt.

If you choose to set up your own independent shipping method, such as use of a freight forwarder or other similar service, Aventon will not replace any Covered Components damaged during such shipping method.

Credit Card Chargebacks:

If any ebike purchase becomes subject to a credit card chargeback in any amount, and you are still in possession of the ebike, then this Limited Warranty shall be invalidated until the credit card chargeback has been resolved.

Claims Process:

Aventon will not replace any covered components under this limited warranty without first seeing photos or video of the damaged covered components.

In order to exercise your right to receive a replacement for a Covered Component under this Limited Warranty, you must:

- Contact the Aventon Product Support team by visiting <https://support.aventon.com/contact-us> or by phone at (866) 300-3311.

The Product Support team will initially work with you on the problem with your ebike to identify potential simple fixes.

- If the Product Support team determines that a Covered Component must be replaced, they will provide you with a set of instructions for returning the defective Covered Component and receiving the replacement.
- After you receive the replacement Covered Component, the Product Support team will also assist in determining how to replace or install the new Covered Component into your ebike.
- You will be responsible for shipping costs associated with returning a Covered Component, unless Aventon agrees in writing to pay for such shipping costs. Replacement Covered Components under this Limited Warranty shall only be shipped to the address of the original purchaser.

THE REMEDIES DESCRIBED ABOVE ARE YOUR SOLE AND EXCLUSIVE REMEDIES AND AVENTON' S ENTIRE LIABILITY FOR ANY BREACH OF THIS LIMITED WARRANTY. AVENTON'S LIABILITY SHALL UNDER NO CIRCUMSTANCES EXCEED THE ACTUAL AMOUNT PAID BY YOU FOR THE EBIKE, NOR SHALL AVENTON UNDER ANY CIRCUMSTANCES BE LIABLE FOR ANY CONSEQUENTIAL, INCIDENTAL, SPECIAL OR PUNITIVE DAMAGES OR LOSSES, WHETHER DIRECT OR INDIRECT.

SOME STATES DO NOT ALLOW THE EXCLUSION OR LIMITATION OF INCIDENTAL OR CONSEQUENTIAL DAMAGES, SO THE ABOVE LIMITATION OR EXCLUSION MAY NOT APPLY TO YOU.

THIS LIMITED WARRANTY GIVES YOU SPECIFIC LEGAL RIGHTS AND YOU MAY ALSO HAVE OTHER RIGHTS, WHICH VARY FROM STATE TO STATE.

TO THE EXTENT PERMISSIBLE UNDER APPLICABLE LAW, Aventon DISCLAIMS ALL IMPLIED WARRANTIES, INCLUDING WITHOUT LIMITATION THE WARRANTIES OF MERCHANTABILITY AND FITNESS FOR A PARTICULAR PURPOSE FOR THE DURATION OF THIS EXPRESS LIMITED WARRANTY.

SOME STATES DO NOT ALLOW LIMITATIONS ON HOW LONG AN IMPLIED WARRANTY LASTS, SO THE ABOVE LIMITATION MAY NOT APPLY TO YOU.

LINK TO ASSEMBLY VIDEO AND ONLINE RESOURCES

Warranty Info

Please visit the “Support” section of the Aventon Bikes website (<https://www.aventon.com/pages/support>) to view the official Adventure.2 Assembly Video Online Resources

For more information on best practices, please visit the Aventon Bikes website (www.aventon.com), Support (<https://www.aventon.com/pages/support>), or contact Aventon Bikes Product Support with any questions.

We are here to help!

If you have questions, please:

Access Aventon Bikes Help Center (<https://www.aventon.com/pages/support>),

Contact us directly by checking <https://support.aventon.com/contact-us>, or

Call Aventon Bikes Product Support 1-866-300-3311