



Smart EV/Moped

User Manual

Model: GF300 **EN**

PRECAUTIONS

Battery and charging:

Charge at 0°C ~ 45°C, discharge at -20°C ~ 60°C, keep the battery dry, do not put the battery in acidic or alkaline liquid, avoid rain, keep away from fire, heat and high temperature environment. It is strictly forbidden to connect the positive and negative poles of the battery reversely, and it is strictly forbidden to damage, insert the battery or short-circuit the battery. Please use the original special charger when charging, do not exceed 6 hours, and the charging current does not exceed 2A. When not in use for a long time, please store the battery in a cool and dry place, and charge the battery for five hours a month. The user must follow the instructions for use when charging, otherwise the consequences will be borne by the user. Pay attention to the battery type and applicable voltage that the charger can charge, and it is strictly forbidden to mix them. When charging, it should be placed in a ventilated environment, and it is strictly prohibited to charge in a confined space or in a hot sun or high temperature environment. When charging, first connect the battery and the charger, and then the power supply; when the battery is fully charged, first cut off the power supply, and then unplug the charger connector. When the green light is on, the power supply should be cut off in time. It is forbidden to connect the charger to the power supply for a long time without charging. During the charging process, if the indicator light is abnormal, a peculiar smell appears, or the charger casing is overheated, stop charging immediately and repair or replace the charger. During the use and storage of the charger, pay attention to avoid the entry of foreign objects, especially avoid the inflow of water or other liquids, so as not to cause a short circuit inside the charger. Try not to carry the charger with the bicycle. If you really need to carry it, you should place it in the toolbox after the shock absorption treatment is done. Do not disassemble or replace the accessories in the charger by yourself.

Riding:

Do not use it until you read the instructions carefully and understand the performance of the product; do not lend it to someone who can't manipulate the product for riding. Before riding the bicycle, check whether the brakes are working. Pay attention to the brake tightness. If the brake is too loose, use an Allen key to tighten it. Pay attention to increasing the braking distance when riding in rain or snow. Applicable age: 16 to 65 years old.

Please be sure to wear a safety helmet when riding a bicycle, follow the traffic rules, and do not drive on motorized lanes and roads with many pedestrians. Please check the tire pressure before riding, the recommended tire pressure is 40 ~ 65PSI.

Downhill and non-paved roads do not exceed 15KM/h.

When using the motor, please be careful not to hit it vigorously and keep the rotating shaft lubricated.

Riding beyond the maximum load is not allowed
(the maximum load is 120KG)

After use, the car can not be parked in the building hall, evacuation stairs, safety exits, and must be parked correctly in accordance with the safety rules.

One-handed riding is prohibited!

Disclaimer:

After riding, please store the bike in a place without sunlight and rain, not in residential buildings; always check the motor and brake; check the screws and the places that need to be fastened regularly, and tighten them regularly.

Recommended torque: (unit: kgf.cm) handlebar screw 60-80, handle screw 175-200, seat cushion screw 175-200, wheel screw 320-450;

The front and rear wheels of the vehicle should be located in the center of the front fork or frame;

Always check the tire for scratches, cracks or excessive wear. The inner tube and the valve should be perpendicular to the wheel hub. Damaged or excessively worn tires need to be replaced immediately. Please find a professional technician to replace your tire. If your tire accidentally punctures and leaks, please contact a professional technician for repair or replacement.

Maintenance and care:

For the product model, specifications or related information mentioned in this User Manual, the company reserves the right of modification and final interpretation; the functions of the specific model mentioned in this User Manual are only applicable to that specific model;

The product models, specifications, or related information mentioned in the User Manual may be changed without notice; without prior written permission of the company, the User Manual may not be copied, modified, reproduced, transmitted, or published in any form. Please read the Manual carefully before using the product, and operate in accordance with the Manual, otherwise the company will not be liable for product damage or personal or property damage caused by improper use or error.

Product function illustration (Model:GF300)



Figure 1 (Bicycle Diagram)

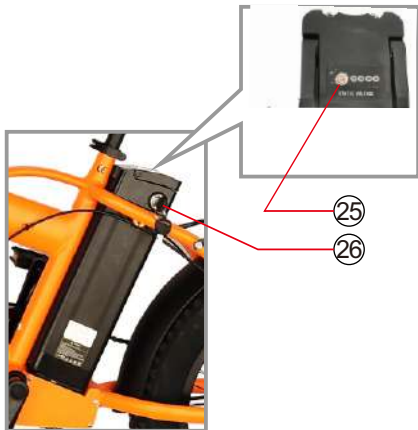

Figure 2 (Left side of the frame)

- | | |
|-------------------|--------------------------------------|
| ① Shift Lever | ⑭ Chainwheel |
| ② Central Display | ⑮ Pedal |
| ③ Brake Lever | ⑯ Chain |
| ④ Stem | ⑰ Rear Derailleur |
| ⑤ Headlight | ⑱ Motor |
| ⑥ Tire | ⑲ Rear reflector |
| ⑦ Rim | ⑳ Rear hanger |
| ⑧ Spoke | ㉑ Seat Tube Adjustment Quick Release |
| ⑨ Reflector | ㉒ Saddle |
| ⑩ Brake Disc | ㉓ Battery Charging Hole |
| ⑪ Front Fork | ㉔ Lithium Battery |
| ⑫ Brake | ㉕ Battery Capacity Button |
| ⑬ Front fender | ㉖ Battery Lock Key Hole |

Product installation:



1.The state of the bicycle after being removed from the carton is as shown in the picture above.
First cut the nylon ties and separate the front wheels from the frame come out and remove the protective foam.



2.Place the bike as shown in the picture above.



3.Insert the handlebar into the folding standpipe and lock it with quick disassembly, then straight the folding standpipe and lock it.

After completion, the state is like the above picture on the right.

4.Tighten the two fixing screws on the folding standpipe with a hexagonal spoon, and turn the attach the standpipe to the nose tube, make sure to use the horizontal pipe to control the nose when there is no loosening phenomenon.

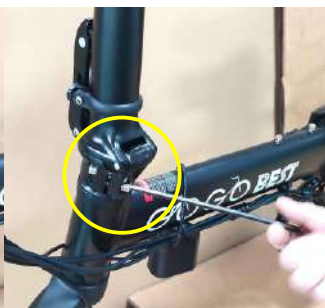

5.Remove the front fork protection lever and loosen the front axle core nut disengage the front axle and place the front wheel on the fork. When installation, Note that the safety buckle on the front fork should be in place.





6. Loosen and take out the fixing screws on the front fork tag, place the front mud plate hook and headlight bracket in the hole, and secure them with screws. Then insert the front clay plate support mounting hole into the front axle and secure it with nuts.



7. After the front wheel is installed, place the bike as shown in the picture above.



8. POpen the accessories carton. There are accessories inside, as shown in the picture above.

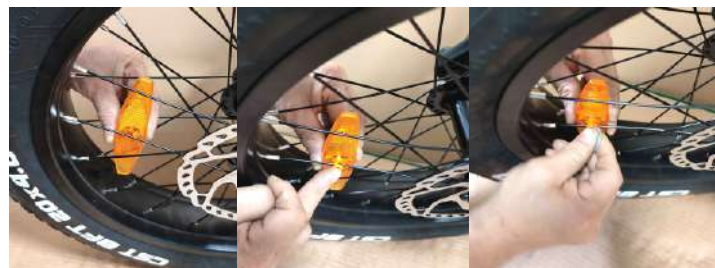

9. Place the reflector on the spoke, press the card into the hole, and use the tool to rotate the clip for locking.



10. When installing the pedals, pay attention to the port of the pedal shaft. The pedal with "WL" stamp is the left pedal, the stamp with "WR" is the right pedal, and the right pedal is installed on the side of the sprocket.

Note: The left pedal is tightened to the left, and the right pedal is tightened to the right.

Display installation:

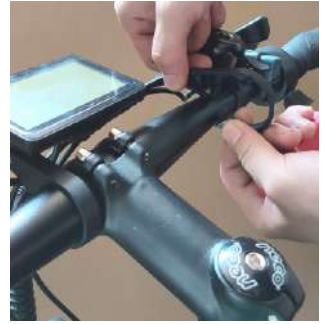

1.The display can be installed only after the handlebar is installed. For the convenience of installation, as shown in the left picture above, one of the fixing clips of the instrument can be completely removed first.

2.First, gently break the fixed pipe clamp of the instrument. In order to install firmly, place the pipe clamp on the horizontal pipe first, and then clamp the pipe into the horizontal pipe, as shown in the middle picture above.; then snap the fixing clip previously removed into the other side of the handlebar tube, as shown in the right picture above; Then reconnect the fixing clip with the display, as shown in the left picture below.

3.Tighten the screws behind the fixing clip of the display to fix it, as shown in the right picture below.



4.Loosen the fixing clip of the button unit, click it into the handlebar tube, and then tighten the fixing screw, as shown in the figure below.



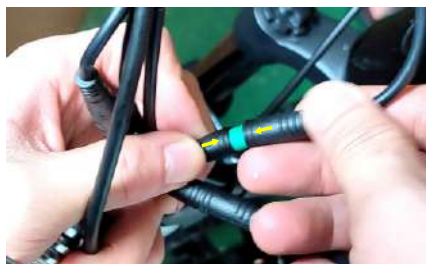

5. Connect the cable of the display, as shown in the figure above; pay attention to the arrow marks of the two connectors.



The status of the display after installation is as shown in the figure above.



The state of the bike after installation is shown in the picture above.

Folding Operation Illustration



Pull out

1: Unscrew the plastic safety buckle on the standpipe quick release, and then release the quick release, and the riser can be folded to the left

2: The standpipe upper and lower adjustable quick releases can adjust the height of the standpipe.

4: Release the upper and lower adjustable quick releases of the seat tube to adjust the seat tube to the lowest position.



Battery lockhole

3: The handlebar adjustable quick release can adjust the handlebar direction

5: Rotate the folding safety buckle up first

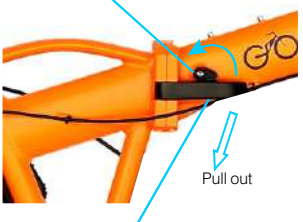

Pull out



State of Frame After Folding

6: Then pull the folding shackle out to fold the frame

Note: The pedals are not installed at the factory and can be installed by using the special wrench coming with the vehicle.



Note when installing the pedals: The pedal with "R" symbol is the right pedal, and that with the "L" symbol is the left pedal.



Battery capacity button Power display lamp button



Press this button on the battery box to display the battery capacity after the green light is lightened. More green lights lightened shows more battery capacity.

Remove the battery

1. First loosen the seat tube with quick release to pull the whole seat tube out, as shown in the figure;



2. Insert the key into the battery lockhole, press the key to the bottom and then rotate it to the left to unlock it, and then pull the battery out.



Pull out



Figure 3 (Handlebar)

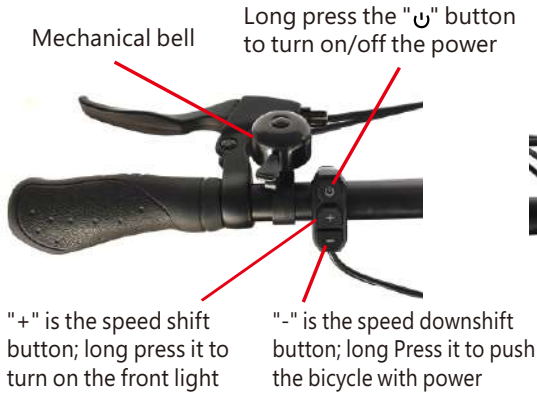

Figure 4 (Left Handlebar)



Figure 5 (Right Handlebar)

Function introduction:

1. Charging: Refer to item 23 of Figure 1, the charging hole can be seen on the right side of the battery in the frame, and it can be charged by connecting the charger. When the battery is full and the charger indicator turns from red to yellow-green, it means it is fully charged.
2. Turn on/off: refer to Figure 4 and press and hold the "⏻" button to turn on/off the power of the display.
3. Display: The display screen lights up after power on, displaying information such as power, speed, motor speed, mileage, etc. The power speed is initially 0. Press the "+" and "-" buttons to increase and decrease the power speed of electric drive mode.
4. Front light: Refer to Figure 4, long press the "+" button to turn on/off the front light.
5. Power-assisted mode: power-assisted riding, step on the pedals of the bicycle, and automatically start electric power after a certain speed. If you don't need assistance, you can turn off the power of the display.
6. Speed transmission: Refer to Figures 4 and 5, when the bicycle is running, you can change the mechanical speed by flipping the shift levers.
7. Electric mode: Refer to Figure 5, press the thumb throttle, and the bicycle can accelerate forward. The greater the pressing range, the faster the bicycle will run. For safety reason, please press the thumb throttle lightly and accelerate slowly.

Remarks: Electricity, load, tire pressure, road environment, chain and wheel axle lubrication, etc. will affect the maximum speed; the range refers to the data obtained from continuous testing from fully charged to completely exhausted with a riding speed of 15-25km/h and a load of 60kg on a flat hardened road; driving habits, temperature, load, tire pressure, road environment and other factors will affect the range.

Display user instructions



Important information about safe use:

1. Before plugging or unplugging the display, please make sure to cut off the power supply of Ebike first. Plugging or unplugging with power will cause permanent electrical damage to the display;
2. When installing the display on the handlebar, do not over tighten the hexagon socket screws. Normally, 0.2N.m of torque can securely install the instrument on the handlebar. Excessive tightening will cause damage to the instrument structure.
3. Do not immerse the display in water or use water spray to clean the meter. When cleaning, please use a soft cloth dampened with water to wipe. Do not use any cleaning agents to wipe.
4. The USB charging port on the display cannot provide waterproof protection when in use. When riding in the rain, please make sure that the protective rubber of the USB port is closed tightly. It is forbidden to use the display to connect external devices in the rain.
5. Do not dispose of the display or any other Ebike accessories as residential garbage. Please abide by local laws and regulations, and dispose of or recycle Ebike accessories in an environmentally friendly manner.
6. The damage or failure of the display caused by improper installation or use is not covered by the after-sales warranty.

□ Parts description and specifications

□ Parts description

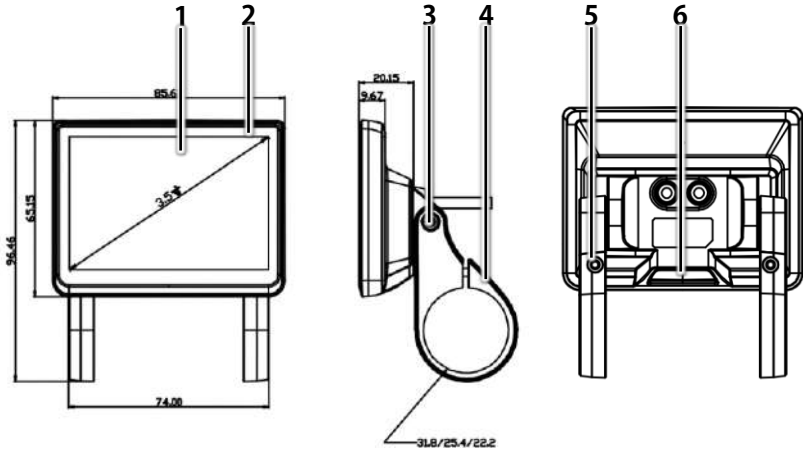

Item	Description	Remark
1	Screen components	
2	Bottom case	
3	Bracket adjustment angle screw M3*6	2 pcs
4	Angle-adjustable fixing bracket	Left and right bracket
5	Bracket fixing screw M3*12	2 pcs
6	USB interface rubber plug	

□ DTK3 Buttons

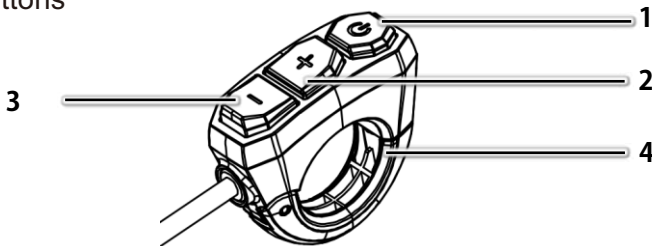

Item	Description	Remark
1	Power button	Long press to control power
2	"+" button	Long press to control the headlight
3	"-" button	
4	Clamping ring	

□ Dimensions

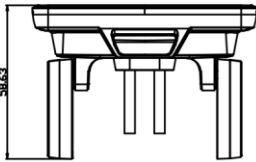
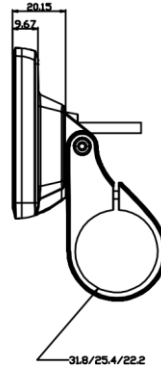
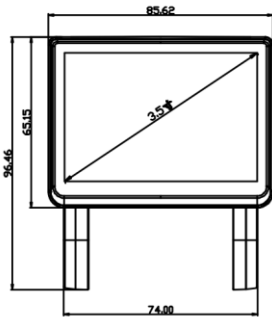

Display Dimensions

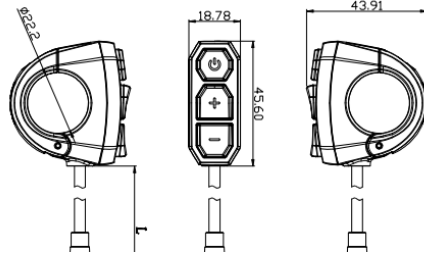

DTK3 Dimensions

□ Reliability

Item	Parameter	Description
1	Power supply parameters	24V / 36V / 48V DC
2	USB power supply capability	5V, 500mA
3	Communication level	3.3V or 5V (optional)
4	Waterproof level	IP66 (USB rubber plug closed)
5	Operating temperature	-20°~+70°
6	Working humidity	15~95% RH
7	Storage temperature	-30°~+80°
8	Storage humidity	30~70% RH
9	Cable tensile strength	For the exposed cables of the finished product, apply a tension of 3kg along the extension direction of the cables, and the cables must not come out of the meter.
10	Tighten ESD requirements	Contact discharge 8KV, non-contact discharge 12KV, Class B judgment standard.

□ Conformities

Item	Parameter	Description
1	CE certificate	Yes
2	RoHS certificate	Yes
3	EN15194 certificate	Yes

□ Installation

□ Install the display unit

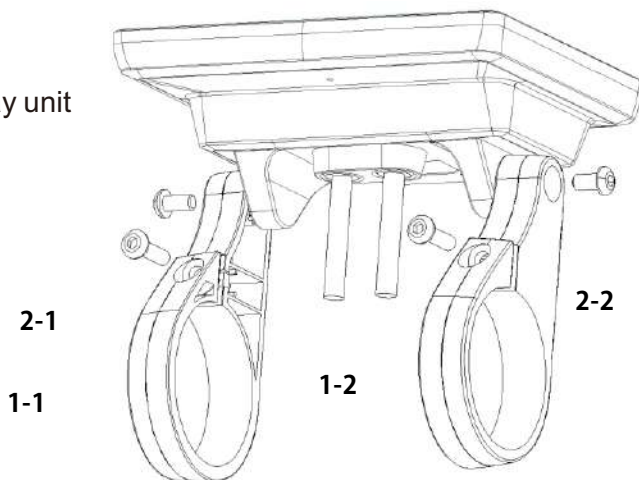

1. Use two M3*12 hexagon socket screws 1-1 and 1-2 to lock the left and right fixing brackets to the handlebars. Tightening torque: 0.2N.m. Do not over-tighten, otherwise it will cause damage to the display.
2. After adjusting the display to a proper angle, use two M3*6 hexagon socket screws 2-1 and 2-2 to tighten it.
3. If you want to install it on a 22.2mm or 25.4mm handlebar, please use the attached adapter rubber ring.

□ Install the button unit

1. Use one M3 hexagon socket screw 3 to lock the control unit on the left handlebar, the recommended position: the right side of the brake fixing ring.
2. Tightening torque: 0.2N.m. Do not over-tighten, otherwise it will cause damage to the instrument.



□ Connect the cable

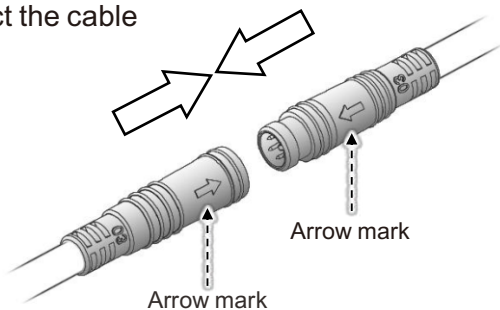

1. Align the arrow marks on the outlet connector of the meter and the Ebike outlet connector, and insert the two cables firmly

□ System operation

□ Initial operation

Turn on the power to the riding interface

1. Long press the "Power" button and the interface is fully lit to enter the riding interface.

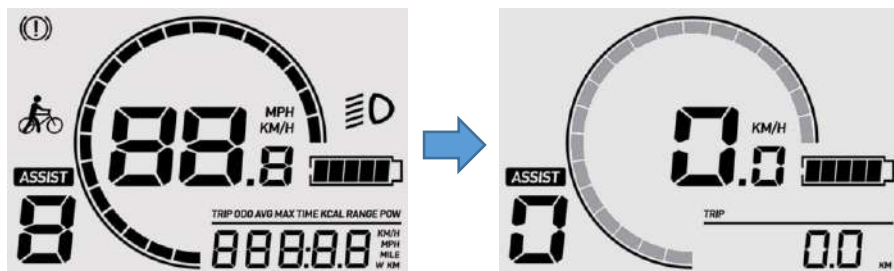

2. Press "+" or "-" button to change the power speed. The default is 0, and the range is 0-5 speed.

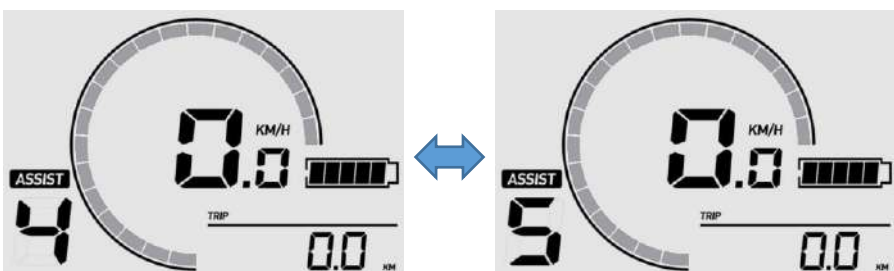
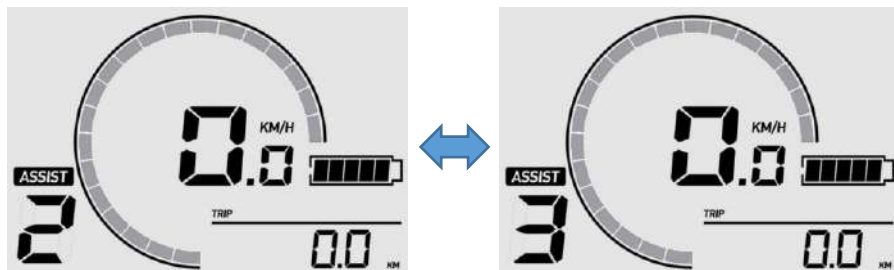
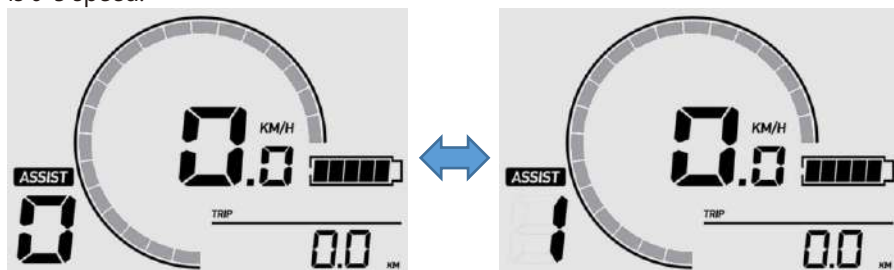

3. Short press the "Power" key to switch the "Multi-function display area".

Trip mileage, range 0.0-9999.9 km

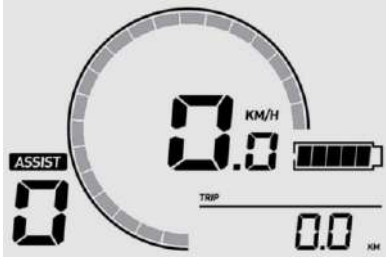

Total mileage, range 0-99999 km

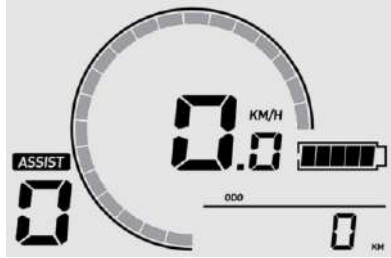

Single average speed, range 0.0-99.9 km/h

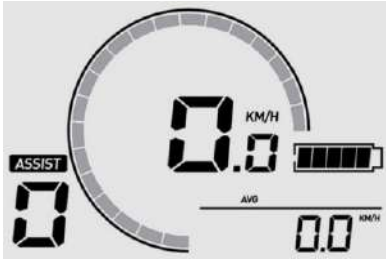

Single maximum speed, 0.0-99.9 km/h



Single riding time, 00:00 -99:59

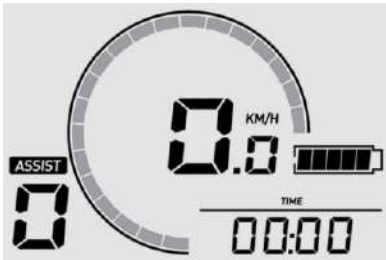

Single calorie consumption, range 0-9999KCal

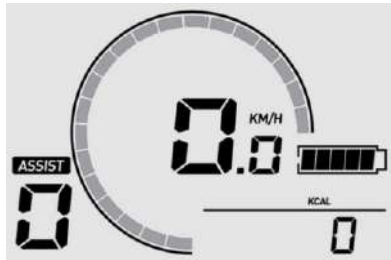

Real-time power, range 0-999 W

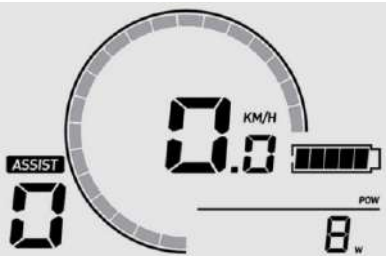

□ DTK3 button functions

1. “+” Button

	Short press	Long press	Long press and hold
Display interface	Increase power speed	Headlight switch	--
Menu interface	Cursor up/increase	--	--

2. “-” Button

	Short press	Long press	Long press and hold
Display interface	Decrease power speed	--	6km/h Boost Mode
Menu interface	Cursor down/decrease	--	--

3. Power Button

	Short press	Long press	Long press and hold
Display interface	Change display info	Power on/off	--
Menu interface	Confirm / Next	--	--

Note: Long press the “+” and “-” buttons at the same time to enter or exit the menu interface; long press the “+” and “power” buttons to clear the Trip information.

□ Meter interface

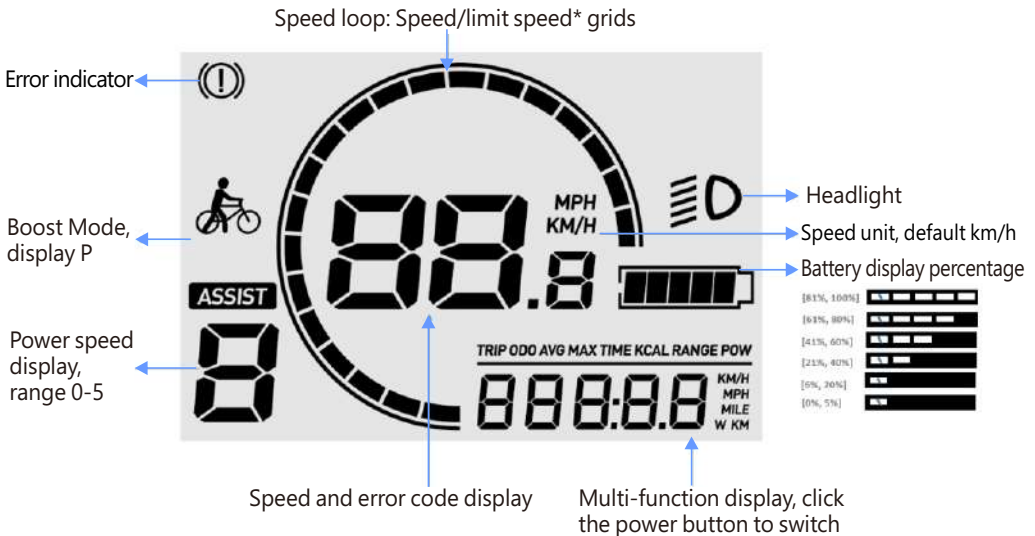

□ Menu interface

In the meter interface, long press the “+” and “-” buttons to enter or exit the menu interface. To ensure user safety, the menu interface can only be entered when the Ebike is stationary (speed is 0); when the speed is not 0, even in the menu setting, it will force to exit the menu and return to the riding interface. In the menu interface, press the “Power” button to jump and confirm the menu items, and the “+” and “-” buttons to set the menu items.

Set wheel diameter

When selecting the "Size" item, press the "Power" button to enter this item, and then press "+" or "-" button to select the wheel diameter, ranging from 04-99, in particular, 27.5 inches displays "27.5"; then press the "Power" button to confirm And exit the item.

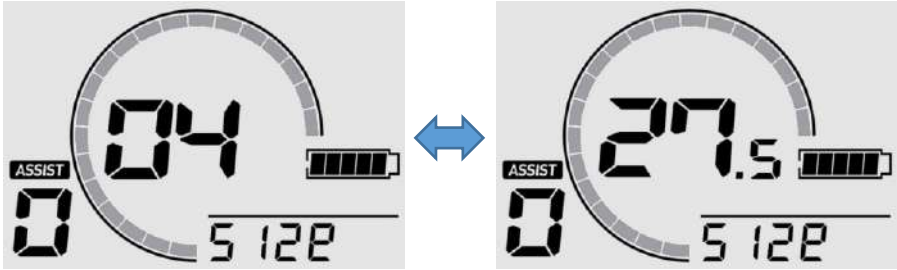

Set speed unit

When selecting the "Unit" menu item, press the "Power" button to confirm KM/H or MPH.

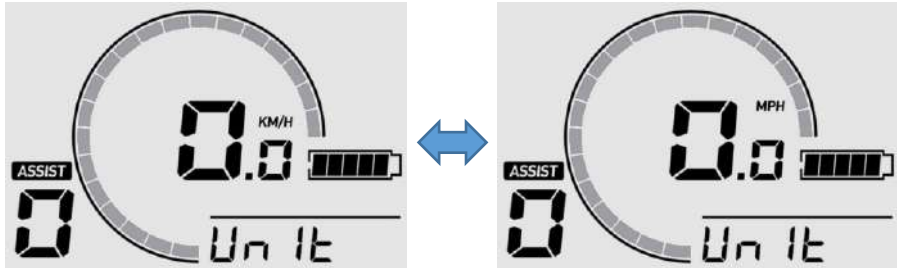

Set speed limit

Select the "Speed" menu item and set the speed limit range from 0.0-99.9 km/h. The final speed limit is determined by the motor. The default is 25 km/h.



Set automatic shutdown time

When selecting the "OFF" menu item, press the "power" button to enter this item, the press "+" or "-" button to confirm the time, the range is 0-10 min, where 0 means to cancel the automatic shutdown; then press the "power" button again to confirm and exit the item.

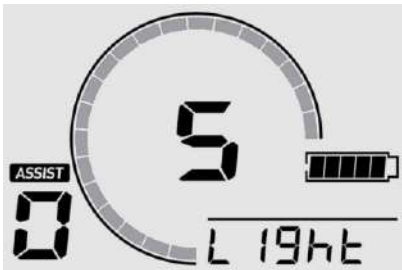
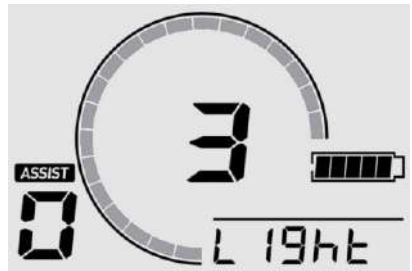
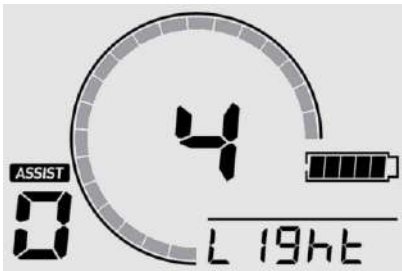
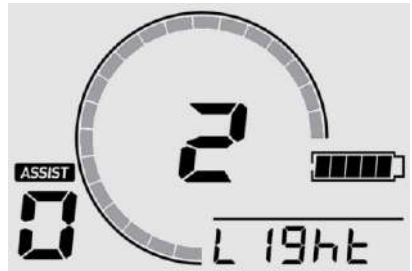
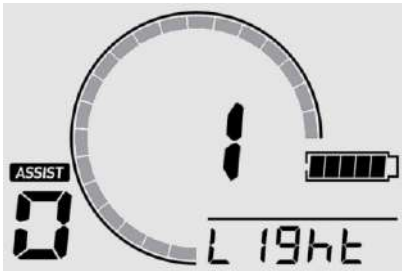
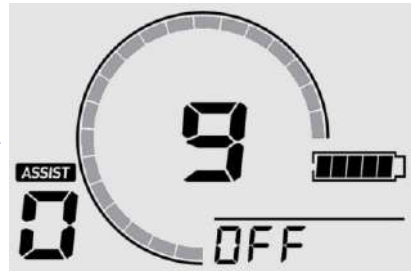
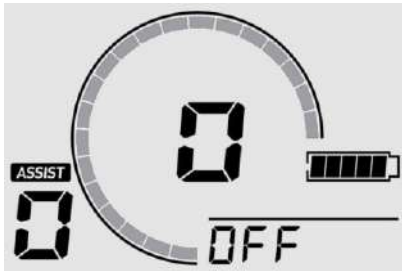

Reset

Select the "Reset" menu item, select "Yes" or "No" with the "+" and "-" buttons, and press the "Power" key to confirm and proceed to the next setting. "No" is displayed by default. Restoring factory settings can restore the default factory parameters, including speed unit, wheel diameter, speed limit, automatic shutdown time and brightness.

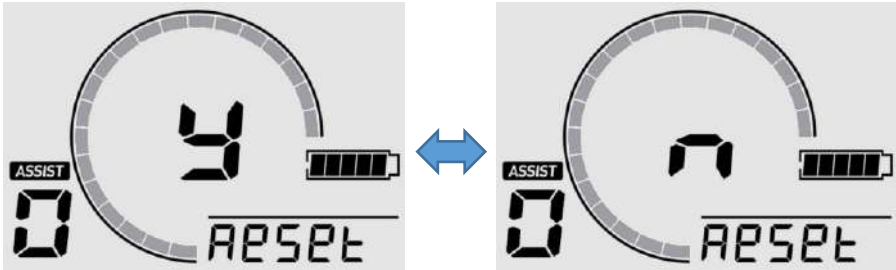

Error code interface

When there is an error, the error indicator will be on and the real-time speed area will be displayed as the error code.

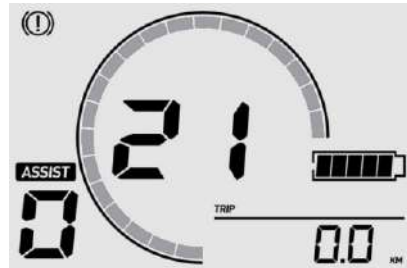

KM5S protocol error code:

Error Code	Description
0x21	Abnormal current or damaged MOSFET
0x22	Thumb throttle abnormal
0x23	Motor phase loss
0x24	Motor Hall abnormality
0x25	Brake abnormal
0x26	Undervoltage
0x30	Communication error



[https: www.gogobest.com](https://www.gogobest.com)
Email: gogobestcs@hotmail.com
cs@gogobest.com