

Fully pre-assembled complete with baffle

# Septic Tank



Approved QLD, NSW, VIC & SA

Ultra-strong, low profile septic tanks have passed the stringent test of AS/NZS 1546.1 certification with flying colours.

## OUTSTANDING FEATURES AND BENEFITS ARE:

- > **10 minute hook-up**  
fittings and baffle are pre-assembled
- > **Australian manufactured**  
offering you maximum support and service
- > **One-piece tank with lifting lugs**  
lightweight and easy to handle
- > **Self-anchoring**  
does not require concrete
- > **Low profile design**  
minimal excavation depth

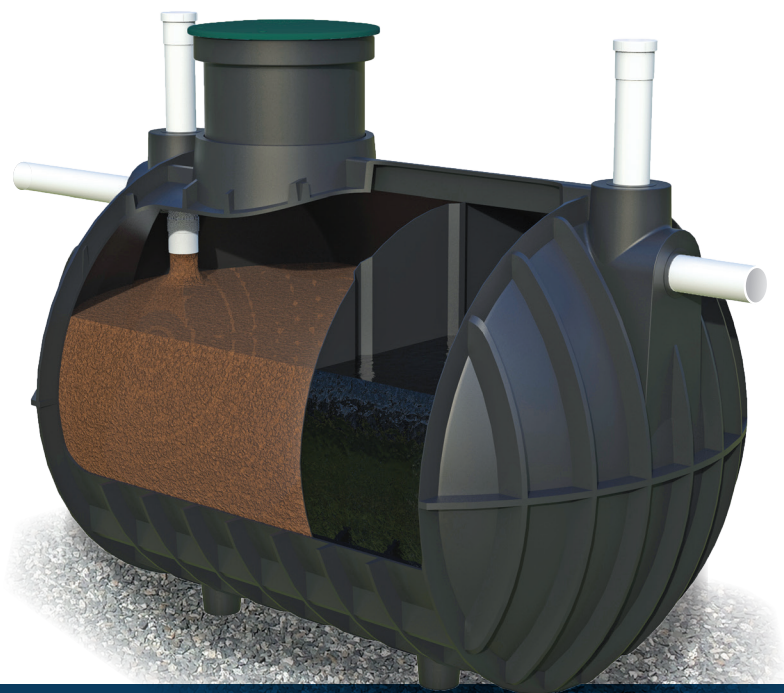

Pictured with riser installed

- ◆ 3,100ltr
- ◆ 4,550ltr



Inlet and outlet fittings come pre-assembled for a 10 minute hook-up



530mm riser available  
\*Optional extra

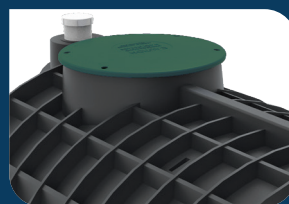

Lid suitable for vehicle traffic, tested to 500kg loading



BSI Certified Product  
AS/NZS 1546.1:2008  
BMP 650823  
Australian/New Zealand Standards

# Compare the Difference

SEPTIC TANK FEATURES	 <b>VS</b> POLYMASTER	 <b>VS</b> OTHER POLY	 CONCRETE
Pre-assembled fittings and baffle	✓	✗	✓
10 minute hook-up time	✓	✗	✗
Lightweight	✓	✓	✗
Transport to site on a standard ute with drop sides and lift into position with a small excavator	✓	✓	✗
Only small installation machinery required. Suits limited access sites	✓	✓	✗
No expensive crane required	✓	✓	✗
Extremely tough and durable design, can withstand knocks and bumps during installation	✓	✗	✗
Small diameter riser = much easier to fit	✓	✗	✗
500kg load-rated manhole cover with tamper-proof bolts. Easy to seal against water ingress	✓	✗	✗
Unique design, self-anchored - no concrete required	✓	✗	✓
Low profile tanks = easier to install in rocky & higher water table conditions	✓	✗	✗

◆ 15 YEAR DESIGN LIFE    ◆ 10 YEAR MANUFACTURER WARRANTY

# National Delivery

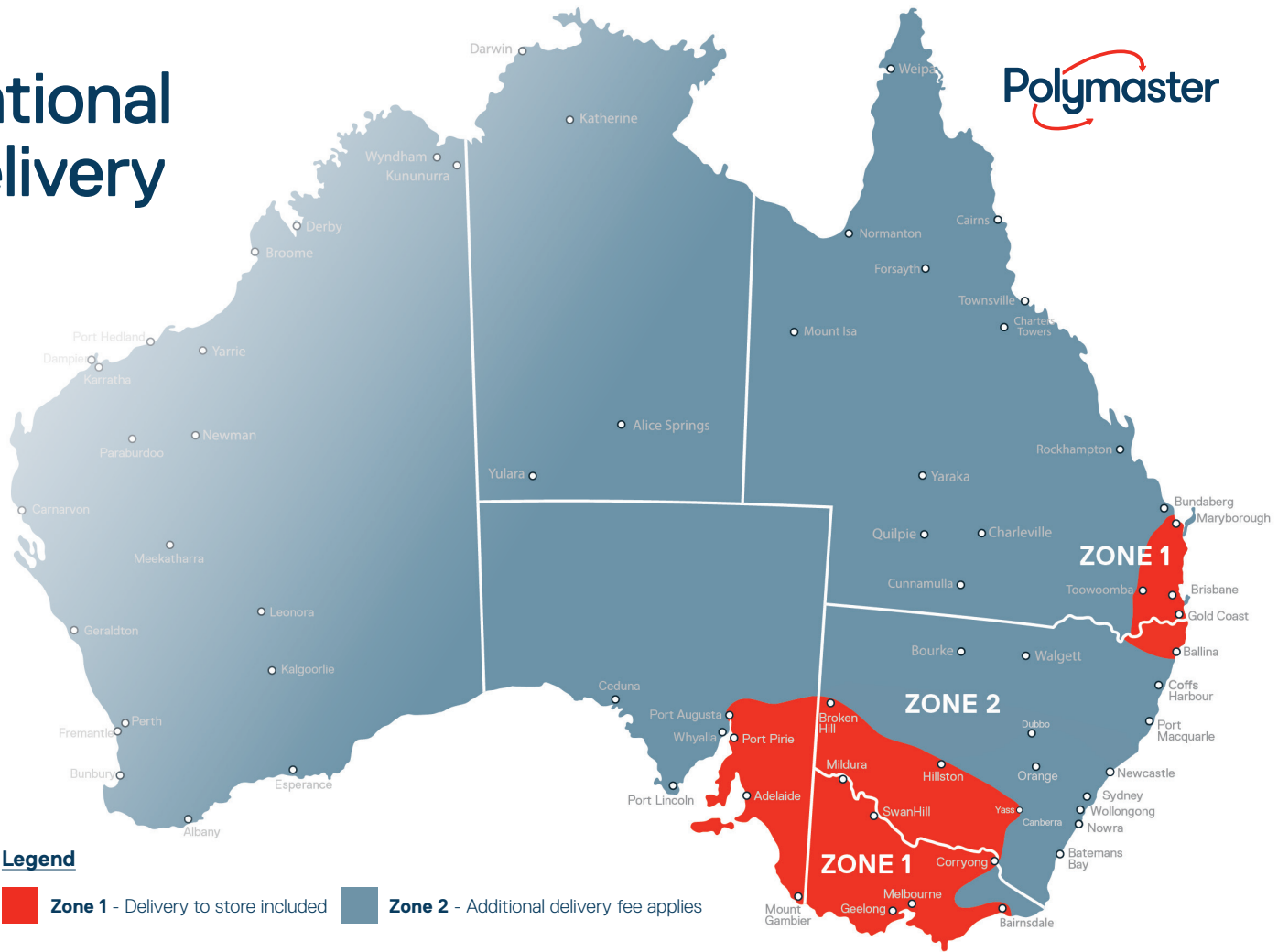

### Legend

- Zone 1 - Delivery to store included
- Zone 2 - Additional delivery fee applies

# Specifications



CODE	CAPACITY	NUMBER OF PERSONS	DIMENSIONS (mm)	MANHOLE (mm)
ST3100	3,100 Ltr	1-5 people	2470L x 1640W x 1700H	Dia 555
ST4550	4,550 Ltr	6-10 people	3520L x 1640W x 1700H	Dia 555
URRM	Optional riser extension 555W x 530H			

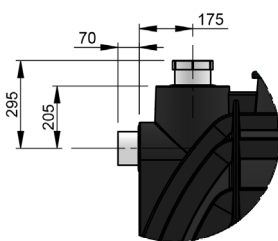
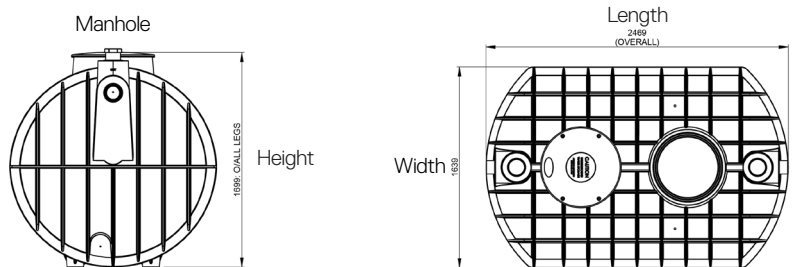

**DETAIL A INLET**

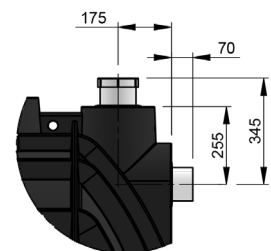
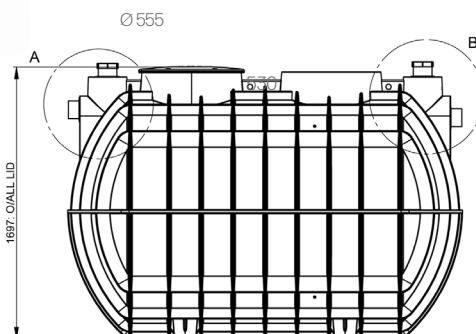

**DETAIL B INLET**



Not all suppliers are the same and I want to compliment your company on the level of service we have received. From the price supplied...and follow up phone call from customer service, your offer of help and warranty advice was welcomed. I just want to commend you on your great customer service. Thank you.

- Sarah, Strathfieldsaye



# Polymaster

Download the **Septic Tank Installation Guide**  
online at [polymaster.com.au](http://polymaster.com.au)

Contact us

1800 062 064 | [polymaster.com.au](http://polymaster.com.au)

Follow us on social media: Polymaster Group

