



Product Guide 2022

Version 1.0

RAINWATER AND AGRICULTURE RANGE

Why Choose Polymaster?

The Polymaster difference; Top grade materials, products that are trialed and tested at every point during the design and manufacturing process, backed up with global quality and process certifications. – This is just the starting point of our promise of quality.



Messaging Service

Know where your tank is and when to expect its delivery



Custom Tank Builder

Industry leading technology to put you in control of your tank building journey



Delivery

Large fleet, fast turn around times & free to many sites. See Delivery & Installation for full details - page 68



Quality Assurance

Polymaster only produces quality products and service, certifying us for the International Standard ISO9001 for quality management



Reliability

Our drivers take pride in getting our tanks exactly where you want them, when you need them



Sourcing Locally

Australian owned & operated since 1994



Find your closest store

Use our online store locator to find your nearest Polymaster retailer.

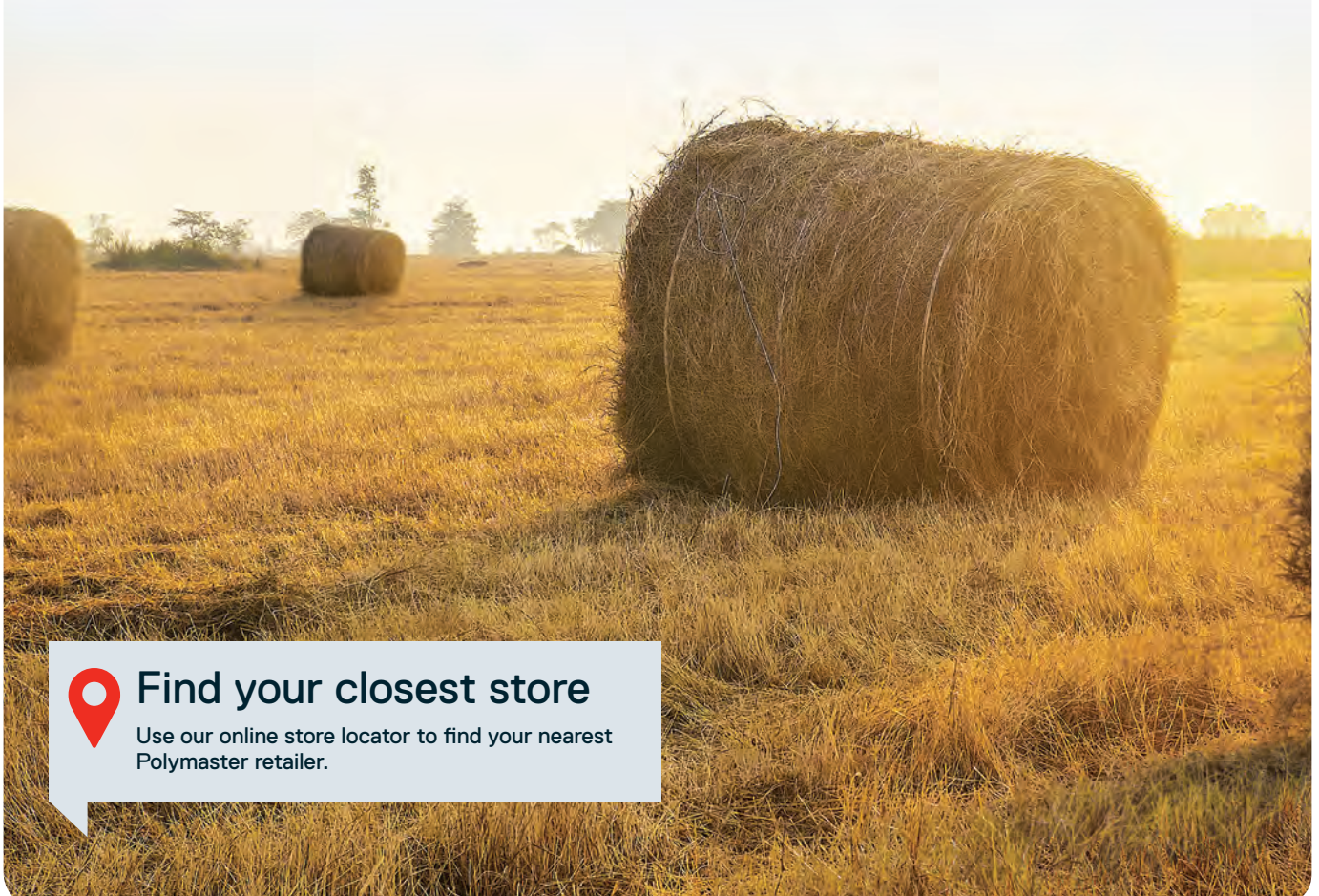



Tanks

Premium Round Rainwater Tanks	8
Polychoice Round Rainwater Tanks	10
Builders Tank & Pump Packages	11
Slimline Tanks & Pump Options	11
Underground Tanks	14
Septic Tanks	15
Pipeline Tanks	16
Molasses Tanks	17
Fertiliser & Fertigation	18
Aquaculture	18
Tanks Accessories	20
Pumps	22



Agriculture

Stock Troughs & Tanks **24**

Round Water Troughs	24
Stock Water Tank & Trough	25
Long Water Troughs	26
Polychoice Troughs	28
Feed Troughs	29
Footrot Baths	30
Trough Spares	31

Feeders & Drinkers **32**

Calf Milk Feeders	32
Lamb Milk Feeders	33
Mobile Gravity Milk Feeders	34
Fence & Stable Drinkers	35
Teats & Accessories	36

Farm Storage & Equipment **37**

Feed Storage Bins	37
Buckets & Scoops	37
Shovels	38
Dog Houses	38
Produce Bins & Liners	39
Bulk Storage	40
Silomaster	41
Silomaster Large Capacity	42
Vehicle Storage	43



Agriculture

Diesel Tanks & Ute Packs	44
Diesel Ute Packs	44
Diesel Transfer Tanks	45
Trailer Packages	46
Diesel Single Skin Smooth Wall Tanks	47
Diesel Self Bunded Tanks	48
Diesel Dispensing Units	50
Diesel Pumps & Accessories	51

AdBlue® Storage	53
------------------------	-----------

Fire Fighting & Water Cartage	54
Water Cartage Tanks	54
Compact Fire Fighting Packages	55
Skid Mounted Fire Fighting Packages	56
Trailer Packages	57
Water Cartage & Fire Fighting Pumps	58

Safety & Spill Containment	59
---------------------------------------	-----------

Order Form	60
-------------------	-----------

Delivery & Installation	61
------------------------------------	-----------

Index	62
--------------	-----------

Why Buy Polymaster Rainwater Tanks



Product Certification

Built to the Rainwater tank Standard AS/NZS 4766:2006 for peace of mind. Licence no. BMP657671 & BMP650824



UV+ Double Strength

Our exclusive UV+ double strength resin gives the best protection against Australia's harsh sun



Food Grade

Our tanks are made from food-grade polyethylene and certified to AS/NZS4020, the Australian Standard for drinking water



Quality Assurance

Polymaster only produces quality products and service, certifying us for the international standard for quality management ISO9001



Extra Thick Walls

Each Polymaster tank undergoes ultrasonic thickness testing and impact testing to ensure material is correct thickness



Fittings Standard

Rainwater Tanks come standard with fittings. Ask us what fittings come with the tank model you are interested in



One Piece Tank Construction

With no joins or seams, our new generation roof design eliminates the need for an internal support pole



BPA Free

For your peace of mind



Made in Australia

Family-owned and operated in Australia since 1994



Tank Builder















Customise your water tank to suit your style and needs with our easy to use 3D Tank Builder



Tank Colours

The Standard Range

With so many choices of Colorbond® matched hues, we've made it easy to perfectly blend your new tank with your new home or surroundings. Our Standard Range takes the guesswork out of matching your tank colour with your exterior walls, guttering or roofing. No wonder this range is an Australian favourite.

					
SCM	MER	WHE	BGE	BGY	SGY
Smooth Cream (Classic Cream™)	Merino (Paperbark®)	Wheat (Harvest®)	Beige	Birch Grey (Dune®)	Slate Grey (Woodland Grey®)
					
MGR	RGM	HGR	HRD	IST	MON
Mist Green (Pale Eucalypt®)	Rivergum (Wilderness®)	Heritage Green (Cottage Green®)	Heritage Red (Manor Red®)	Metal Grey (Ironstone®)	Monument®
					
WHI	EVH	GGY	WIN	BAS	GUL
White (Surf Mist®)	Evening Haze®	Gull Grey (Shale Grey)	Windspray	Basalt	Gully
					
WAL	MAN	JAS	MTB		
Wallaby	Mangrove®	Autumn Brown (Jasper®)	Mountain Blue (Deep Ocean®)		

Please note actual colours may vary on a real product compared to a printed brochure.
Check out colour swatches at your local distributor for accurate colour representation.

Contact us to discuss your colour project on **1800 062 064**

Colours are shown for illustrative purposes only and may vary. Polymaster will not be held liable for incorrect colour impressions. Request your Polymaster colour sample to view colours. *COLORBOND® and colour names are registered trademarks of Blue Scope Steel Ltd.™ Polymaster tank colours represented match COLORBOND® steel colours. As we process our own resin we are able to offer a vast range of custom colours, available at an additional cost.

Rainwater Tanks

Premium Round Water Tanks



CODE	PROFILE	CAPACITY (Litres)	DIAMETER	OVERALL HEIGHT	INLET HEIGHT
RWT200	Corrugated	200	600	900	900
RWT600	Corrugated	600	1000	950	950
RWT1000	Corrugated	1,000	1000	1500	1500
RWT1600	Corrugated	1,600	1250	1610	1500
RWT2270T*	Corrugated	2,270	1300	2000	1920
RWT2270LP*	Corrugated	2,270	1700	1310	1200
RWT3300	Corrugated	3,300	1520	2100	2000
RWT4500T*	Corrugated	4,500	1700	2200	2100
RWT4500LP*	Corrugated	4,500	2150	1580	1380
RWT5000	Corrugated	5,000	1950	2170	1960
RWT7100	Corrugated	7,100	2150	2300	2120
RWT9000	Corrugated	9,000	2500	2260	2050
RWT13600	Corrugated	13,600	3100	2450	2100
RWT22500	Corrugated	22,500	3560	2800	2470
RWT31700	Corrugated	31,700	4100	3040	2610
RWT50KL	Smooth	50,000	4600	3440	3290

*T = Tall

*LP = Low Profile



CODE	STRAINER (Position)	STRAINER (Size)	OVERFLOW (Alternative)	OUTLET* (Std Position)	OUTLET SIZE	UPGRADE BALL VALVE & OUTLET	MANHOLE COVER & STRAINER
RWT200	Centre	200	12	6	25	40 - BV1.5A 50 - BV2A	Manhole - MHC6 Strainer - S2
RWT600	Centre	200	12	6	25	40 - BV1.5A 50 - BV2A	Manhole - MHC6 Strainer - S2
RWT1000	Centre	200	12	6	25	40 - BV1.5A 50 - BV2A	Manhole - MHC6 Strainer - S2
RWT1600	12	300	11/4	6	25	40 - BV1.5A 50 - BV2A	Manhole - MHC5 Strainer - S3
RWT2270T	12	300	11/5	6	25	40 - BV1.5A 50 - BV2A	Manhole - MHC5 Strainer - S3
RWT2270LP	12	400	11/4	6	25	40 - BV1.5A 50 - BV2A	Manhole - MHC3/MHC4 Strainer - S4
RWT3300	12	300	11/4	6	25	40 - BV1.5A 50 - BV2A	Manhole - MHC5 Strainer - S3
RWT4500T	12	400	11/4	6	25	40 - BV1.5A 50 - BV2A 80 - BV3A	Manhole - MHC3/MHC4 Strainer - S4
RWT4500LP	12	400	11/3/7	6	25	40 - BV1.5A 50 - BV2A 80 - BV3A	Manhole - MHC3/MHC4 Strainer - S4
RWT5000	12	400	11/3/7	6	25	40 - BV1.5A 50 - BV2A 80 - BV3A	Manhole - MHC3/MHC4 Strainer - S4
RWT7100	12	400	11/3/7	6	40	50 - BV2A 80 - BV3A	Manhole - MHC3/MHC4 Strainer - S4
RWT9000	12	400	11.30/2.30/ 5.30/8.30	6	40	50 - BV2A 80 - BV3A	Manhole - MHC3/MHC4 Strainer - S4
RWT13600	12	400	11/2/5/8	4	40	50 - BV2A 80 - BV3A 100 - BV4A	Manhole - MHC3/MHC4 Strainer - S4
RWT22500	12	400	11.30/2.30/ 5.30/8.30	4	40	50 - BV2A 80 - BV3A 100 - BV4A	Manhole - MHC3/MHC4 Strainer - S4
RWT31700	12	400	11.30/2.30/ 5.30/8.30	4	40	50 - BV2A 80 - BV3A 100 - BV4A	Manhole - MHC3/MHC4 Strainer - S4
RWT50KL	12/6	500	2/4/6/8/10/12	4	40	50 - BV2A 80 - BV3A 100 - BV4A	Manhole - MHCA Strainer - S5

DIMENSIONS

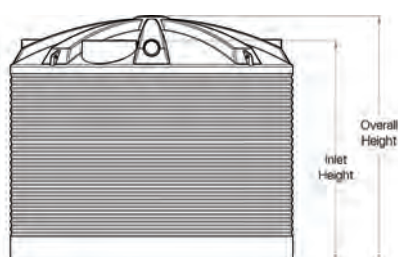

Fit Out Clock

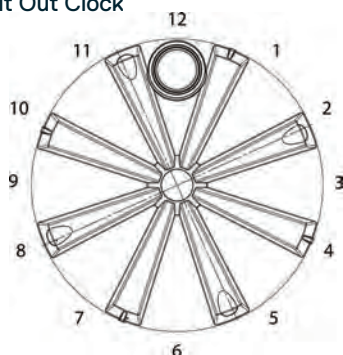

Refer to table for strainer, overflow and outlet positions available for each tank size.

KEY FEATURES

- Self supporting roof means no support poles are necessary
- One piece construction means no joins or seams
- Solid brass threaded outlet & ball valve as standard
- *Outlet location can be moved from standard based on positions on the Fit Out Clock
- Upgraded outlet and ball valves are additional cost
- Replacement manhole covers and strainers available
- Available in 22 Colorbond Colours
- 90mm overflow

Strainer



Outlet & Ball Valve

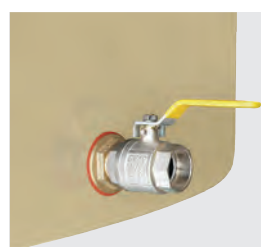

Overflow



**CREATE YOUR
PERFECT MATCH**

BUILD YOUR OWN TANK



You can change location of the outlet and overflow with our new 3D Tank Builder

Rainwater Tanks

Polychoice Round Water Tanks



CODE	PROFILE	CAPACITY (Litres)	DIAMETER	OVERALL HEIGHT	INLET HEIGHT
PCR2000	Smooth	2,000	1175	2255	2185
PCR4000	Smooth	4,000	1600	2200	2150
PCR5000	Smooth	5,000	1800	2200	2120
PCR7000	Smooth	7,000	2200	2200	2020
PCR10000	Smooth	10,000	2480	2350	2170
PCR13500	Smooth	13,500	2830	2630	2470
PCR22500	Smooth	22,500	3573	2879	2559
PCR27000	Smooth	27,000	3573	3339	3019

CODE	STRAINER (Position)	STRAINER (Size)	OVERFLOW (Alternative)	*OUTLET (Std Position)	OUTLET SIZE	UPGRADE OUTLET	MANHOLE COVER & STRAINER
PCR2000	12	300	10.30, 1.30, 4.30, 7.30	6	25	40 - BV1.5A 50 - BV2A	Manhole - MHC6 Strainer - S3
PCR4000	12	400	10.30, 1.30, 4.30, 7.30	6	25	40 - BV1.5A 50 - BV2A	Manhole - MHC7 Strainer - S4
PCR5000	12	400	10.30, 1.30, 4.30, 7.30	6	25	40 - BV1.5A 50 - BV2A	Manhole - MHC7 Strainer - S4
PCR7000	12	400	10.30, 1.30, 4.30, 7.30	6	25	40 - BV1.5A 50 - BV2A	Manhole - MHC7 Strainer - S4
PCR10000	12	400	10.30, 1.30, 4.30, 7.30	6	40	50 - BV2A 80 - BV3A 100 - BC4A	Manhole - MHCA Strainer - S4
PCR13500	12	400	10.30, 1.30, 4.30, 7.30	6	40	50 - BV2A 80 - BV3A 100 - BV4A	Manhole - MHCA Strainer - S4
PCR22500	12	500	10.30, 1.30, 4.30, 7.30	6	40	50 - BV2A 80 - BV3A 100 - BV4A	Manhole - MHCA Strainer - S5
PCR27000	12	500	10.30, 1.30, 4.30, 7.30	6	40	50 - BV2A 80 - BV3A 100 - BV4A	Manhole - MHCA Strainer - S5

DIMENSIONS

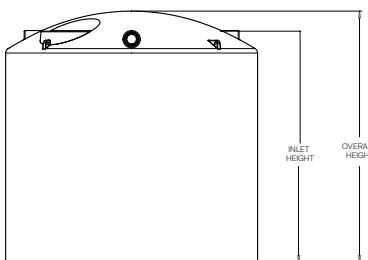

Fit Out Clock

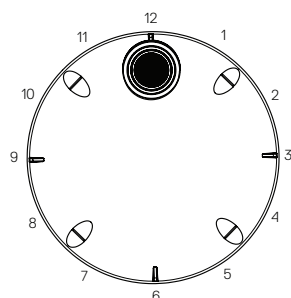

KEY FEATURES

- Self supporting roof means no support poles are necessary
- One piece construction means no joins or seams
- Solid brass threaded outlet and ball valve as standard
- *Outlet location can be moved from standard based on positions on the Fit Out Clock
- Upgraded outlet and ball valves are additional cost
- Replacement manhole covers and strainers available
- Available in 22 Standard Colorbond colours

Refer to table for strainer, overflow and outlet positions available for each tank size.



Slimline Tanks

Builders Tank & Pump Packages



CODE	PUMP CAPABILITY	CAPACITY (Litres)	PUMP CODE	LENGTH	WIDTH	HEIGHT	INLET HEIGHT	OUTLET (Position)	OUTLET SIZE
BSLT2020H4	Single Storey Dwellings	2,020	MHR20-370	2105	735	2010	2010	6&12	25
BSLT2020H5	Double Storey Dwellings	2,020	MHR20-550	2105	735	2010	2010	6&12	25

Accessories

CODE	DESCRIPTION
BSLT2020PC	Pump Cover for BLST2020
MHC8	Inspection Cover 400mm
S4	Inlet Strainer 400mm

PUMP INFORMATION

Automatic hydraulic Rain/Mains water changeover device designed for pressure pump supply systems in harvesting rainwater for the toilet, laundry and household applications with automatic mains backup.

*Refer to Page 24 & 25 for Pump Details.

KEY FEATURES

- 10 minute quick install - pump built in, just hook it up
- Moulded handgrips for easy lifting
- 2 x 90mm overflows + 1 cap
- 2 x outlets + 1 cap
- Flexhose 20mm x 600mm Female thread
- Hoses for connection at approximately 400mm high
- Available in 22 Standard Colorbond colours
- Fits through a standard doorway

DIMENSIONS

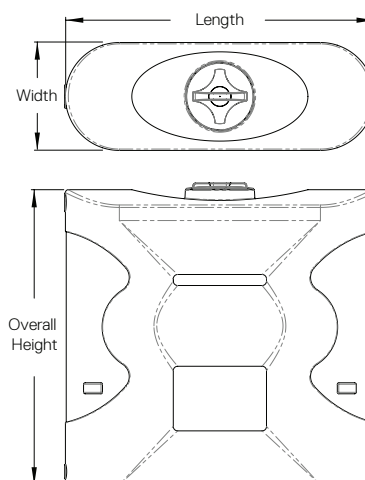

CREATE YOUR PERFECT MATCH

BUILD YOUR OWN TANK

You can change location of the outlet and overflow with our new 3D Tank Builder



Slimline Tanks & Pump Options



Tank Only

CODE	CAPACITY (Litres)	LENGTH	WIDTH	INLET HEIGHT
PCST600	600	1220	580	1265
PCST1050	1,050	1460	690	1515
PCST2000	2,000	2370	600	2010
PCST3000	3,000	2570	790	2050
PCST5000	5,000	3290	1020	2010

CODE	STRAINER (Position)	STRAINER (Size)	OVERFLOW POSITION	OUTLET POSITION	OUTLET SIZE	MANHOLE COVER & STRAINER
PCST600	6 Std/12 Alt	300	12 Std/6 Alt	6 Std/12 Alt	25	Manhole Cover - MHC9 Strainer - S3
PCST1050	6 Std/12 Alt	400	12 Std/6 Alt	6 Std/12 Alt	25	Manhole Cover - MHC8 Strainer - S4
PCST2000	6 Std/12 Alt	400	12 Std/6 Alt	6 Std/12 Alt	25	Manhole Cover - MHC8 Strainer - S4
PCST3000	6 Std/12 Alt	400	12 Std/6 Alt	6 Std/12 Alt	25	Manhole Cove - MHC8 Strainer - S4
PCST5000	6 Std/12 Alt	400	12 Std/6 Alt	6 Std/12 Alt	25	Manhole Cover - MHC8 Strainer - S4

Tank & Submersible Pump System

CODE	CAPACITY (Litres)	LENGTH	WIDTH	INLET HEIGHT	PUMP CODE
PCST1050AP	1,050	1460	690	1515	HHR-370S-PC
PCST2000AP	2,000	2370	600	2010	HHR-370S-PC
PCST3000AP	3,000	2570	790	2050	HHR-370S-PC
PCST5000AP	5,000	3290	1020	2010	HHR-370S-PC

CODE	STRAINER (Position)	STRAINER (Size)	OVERFLOW POSITION	OUTLET POSITION	OUTLET SIZE	MANHOLE COVER & STRAINER
PCST1050AP	6 Std/12 Alt	400	12 Std/6 Alt	6 Std/12 Alt	25	Manhole Cover - MHC8 Strainer - S4
PCST2000AP	6 Std/12 Alt	400	12 Std/6 Alt	6 Std/12 Alt	25	Manhole Cover - MHC8 Strainer - S4
PCST3000AP	6 Std/12 Alt	400	12 Std/6 Alt	6 Std/12 Alt	25	Manhole Cover - MHC8 Strainer - S4
PCST5000AP	6 Std/12 Alt	400	12 Std/6 Alt	6 Std/12 Alt	25	Manhole Cover - MHC8 Strainer - S4

**CREATE YOUR
PERFECT MATCH**
BUILD YOUR OWN TANK



You can change location of the outlet and overflow with our new 3D Tank Builder

Tank & Garden Pump System

CODE	CAPACITY (Litres)	LENGTH	WIDTH	INLET HEIGHT	PUMP CODE	PUMP COVER SUPPLIED
PCST1050GPS	1,050	1460	690	1515	DHJ600	PC01
PCST2000GPS	2,000	2370	600	2010	DHJ600	PC01
PCST3000GPS	3,000	2570	790	2050	DHJ600	PC01
PCST5000GPS	5,000	3290	1020	2010	DHJ600	PC01

CODE	STRAINER (Position)	STRAINER (Size)	OVERFLOW POSITION	OUTLET POSITION	OUTLET SIZE	MANHOLE COVER & STRAINER
PCST1050GPS	6 Std/12 Alt	400	12 Std/6 Alt	6 Std/12 Alt	25	Manhole Cover - MHC8 Strainer - S4
PCST2000GPS	6 Std/12 Alt	400	12 Std/6 Alt	6 Std/12 Alt	25	Manhole Cover - MHC8 Strainer - S4
PCST3000GPS	6 Std/12 Alt	400	12 Std/6 Alt	6 Std/12 Alt	25	Manhole Cover - MHC8 Strainer - S4
PCST5000GPS	6 Std/12 Alt	400	12 Std/6 Alt	6 Std/12 Alt	25	Manhole Cover - MHC8 Strainer - S4

DIMENSIONS

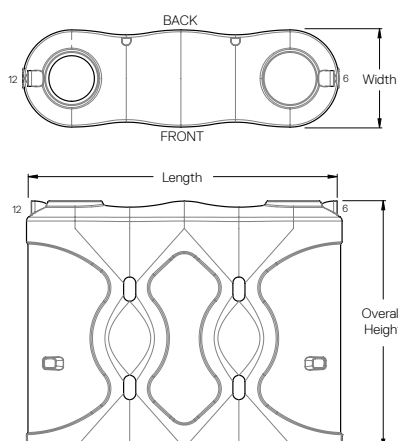

PUMP INFORMATION

Automatic hydraulic Rain/Mains water changeover device designed for pressure pump supply systems in harvesting rainwater for the toilet, laundry and household applications with automatic mains backup.

*Refer to pages 24 & 25 for Pump Details



KEY FEATURES

- Space saving modern design
- 25mm solid brass outlet
- Moulded handgrips for easy lifting
- 90mm overflow
- Available in 22 Colorbond Colours



Underground Tanks



CODE	DESCRIPTION	CAPACITY (Litres)	LENGTH	WIDTH	HEIGHT	OUTLET SIZE
URT3300B	Tank Only	3,300	2450	1640	1665	32mm BSPF
URT5000B	Tank Only	5,000	3520	1640	1665	32mm BSPF
URT3300VF	Tank with Vortex Filter	3,300	2450	1640	1665	32mm BSPF
URT5000VF	Tank with Vortex Filter	5,000	3520	1640	1665	32mm BSPF
URT3300VF/PC	Tank with Vortex Filter inc submersible pump & automatic changeover device	3,300	2450	1640	1665	32mm BSPF
URT5000VF/PC	Tank with Vortex Filter inc submersible pump & automatic changeover device	5,000	3520	1640	1665	32mm BSPF
URT3300VF/GP	Tank with Vortex Filter & garden pump with press control	3,300	2450	1640	1665	32mm BSPF
URT5000VF/GP	Tank with Vortex Filter & garden pump with press control	5,000	3520	1640	1665	32mm BSPF

Pump Details

TYPE	VOLTAGE	POWER (kW)	HEAD	FLOW	INLET	OUTLET	WARRANTY
Submersible Pump (PC)	220-240v	0.75kW (750 watts)	36m	115LPM	20mm BSPM	20mm BSPM	2 years
Garden Pump (GP)	220-240v	0.37kW (370 watts)	36m	82LPM		25mm BSPF	2 years

Accessories

CODE	ACCESSORIES
URRM	500mm Riser - for deeper installations
URTL	Lid to suit Underground Tanks

VORTEX FINE FILTER

Self cleaning filter removes sediment and debris, providing you with clean water for storage. Wall mounting bracket available.

Example Setup Underground Tank with Vortex Filter and Submersible Pump options



KEY FEATURES

- Child-proof lid secured with tamper proof screws
- Self-anchoring
- Low profile design - minimal excavation required
- Uni Seals supplied
- Tank to tank connection point

DIMENSIONS

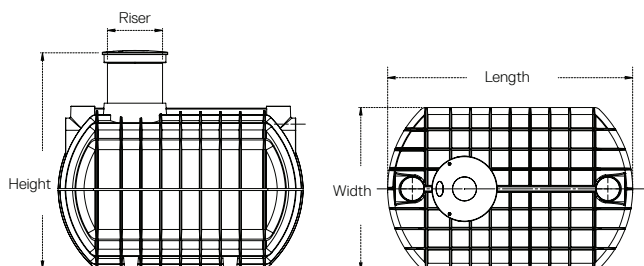

Septic Tanks



CODE	DESCRIPTION	CAPACITY (Litres)	WEIGHT (KG)	LENGTH	WIDTH	HEIGHT	INLET SIZE	OUTLET SIZE	NO. OF PERSONS
ST3100	Septic Tank	3,100	200	2450	1640	1665	100	100	1-5 people
ST4550	Septic Tank	4,550	325	3520	1640	1665	100	100	6-10 people

Accessories

CODE	ACCESSORIES	KEY FEATURES
STLIDHGR	Lid to suit Septic Tank	<ul style="list-style-type: none"> Self anchoring - does not require concrete Fittings and baffle pre-installed Certified for NSW, VIC, SA 10 minute hook up Low profile design - minimal excavation required One piece construction 100mm inlet and outlet preinstalled Heavy duty lid tested to 500kg loading 500mm riser extension available
URTL-SMALL	Lid Only For Underground Tank HGR - Secondary Port Access Lid	
URRM	500mm Riser - for deeper installations	
URRM-SMALL	Riser - Underground Tank Secondary Port Access Lid	

DIMENSIONS

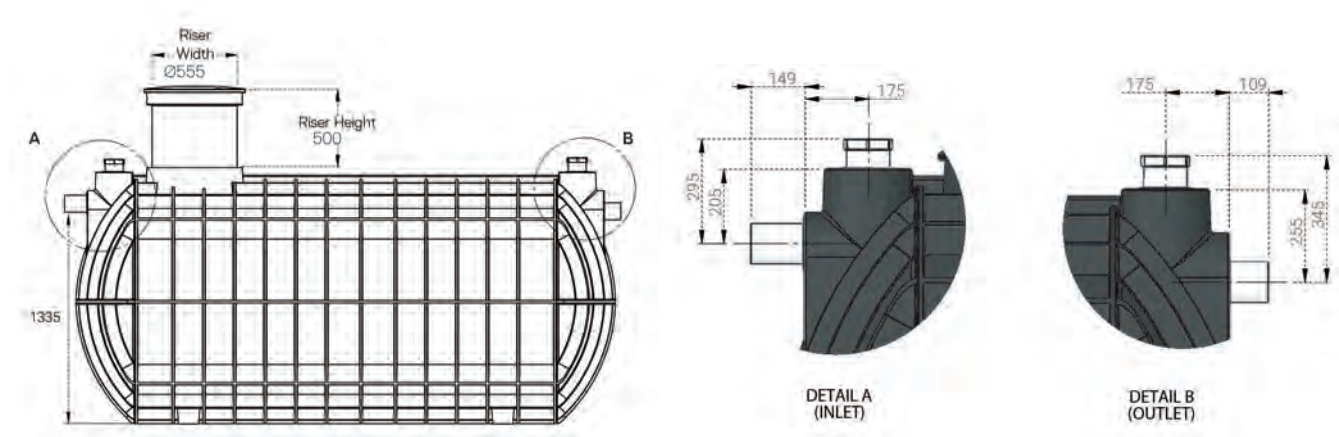

Pipeline Tanks



CODE	CAPACITY (Litres)	DIAMETER	INLET HEIGHT	OVERALL HEIGHT	OVERFLOW SIZE	INLET / OUTLET SIZE
PLT9000	9,000	2500	2050	2260	90	32+50
PLT13600	13,600	3100	2100	2450	90	32+50
PLT22500	22,500	3560	2470	2800	90	32+50
PLT31700	31,700	4100	2610	3040	90	32+50
PLT50KL	50,000	4600	3290	3440	90	32+50

KEY FEATURES

- Inspection cover
- 90mm overflow/breather & screen
- AFV2LB 32mm brass fitting and 25mm poly float
- 50mm outlet and ball valve

STANDARD FITTINGS AND LOCATIONS

12:00	Inspection Cover
2:30	Breather /Overflow
4:00	50mm Brass Outlet & Ball Valve
11:30	Fitting & Float Valve

* Pipeline fittings pg 25.

DIMENSIONS

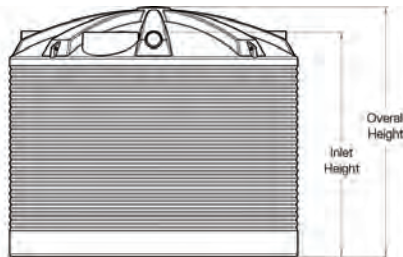

Fit Out Clock

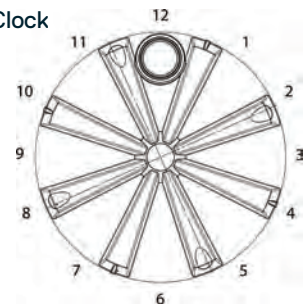

Refer to table for strainer, overflow and outlet positions available for each tank size.

Made to Order -
Call us today to discuss your fit out and fitting options



PLT31700

Optional internal pipework fit out available

Molasses Storage Tanks



CODE	PROFILE	CAPACITY (Litres)	DIAMETER	OVERALL HEIGHT	INLET HEIGHT	OVERFLOW SIZE	OUTLET SIZE
MOL13600	Corrugated	13,600	3100	2450	2100	90	80
MOL22500	Corrugated	22,500	3560	2800	2470	90	80
MOL31700	Corrugated	31,700	4100	3040	2610	90	80
MOL50KL	Smooth	50,000	4600	3440	3290	90	80

KEY FEATURES

- Heavy duty wall thickness
- Ideal for liquids up to 1.4SG
- Standard with 80mm brass outlet and inspection cover
- Fitted with overflow as breather and screen

DIMENSIONS

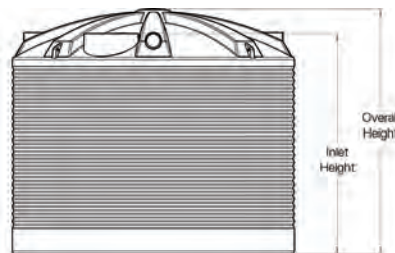

Fit Out Clock

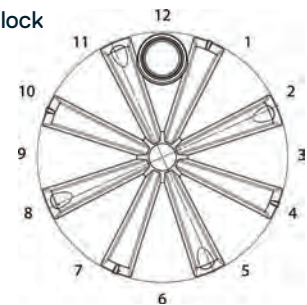

Refer to table for strainer, overflow and outlet positions available for each tank size.



MOL31700

Liquid Fertiliser Storage

Liquid Fertiliser Storage Tanks



CODE	CAPACITY (Litres)	DIAMETER	INLET HEIGHT	OVERALL HEIGHT	OVERFLOW SIZE	TOP FILL KIT
LFT9000	9,000	2500	2050	2260	90	LFTK
LFT13600	13,600	3100	2100	2450	90	LFTK
LFT22500	22,500	3560	2470	2800	90	LFTK
LFT31700	31,700	4100	2610	3040	90	LFTK
LFT50KL	50,000	4600	3290	3440	90	LFTK

KEY FEATURES

- Heavy duty construction to suit liquids up to 1.4SG
- Level indicator as standard
- Inspection cover
- Standard with 50mm Stainless Steel Outlet, Ball Valve and Camlock



LFTK

*Optional extra



LFT22500

*Pole not included

STANDARD FITTINGS AND LOCATIONS

12:00	Inspection Cover
12:30	2" Stainless Steel Outlet (LH02SS)
12:30	2" Stainless Steel Camlock (bottom fill connection)
12:30	2" Stainless Steel Ball Valve
1:30	Liquidator - True Level Indicator (LQ01)
2:30	Breather / Overflow

3" STAINLESS STEEL UPGRADE OPTION

- 3" Outlet (**LH03SS**)
- 3" Camlock (**SC80-F**)
- 3" Ball Valve (**SSBV3**)

Fertigation Tank + Base & Venturi Fitout



CODE	CAPACITY	DIMENSIONS	LID
FT2000B+V	2,000 ltr	2000 DIA x 1000 H	FTL2000
FT5000B+V	5,000 ltr	2850 DIA x 1180 H	
FT9000B+V	9,000 ltr	3500 DIA x 1280 H	
FTL2000	Lid to suit 2,000 ltr Fertigation Tank	2180 DIA	

Recommended Pump for Venturi Setup

CODE	DESCRIPTION	ENGINE/ PUMP	POWER (HP)	HEAD	FLOW (LPM)	INLET	OUTLET	WARRANTY
HTP750VR	Chemical Transfer Pump Honda 6.5HP	Honda/Onga	6.5	40m	750	50mm NPT	50mm NPT	2 years

KEY FEATURES

- No internal pipework within tank to get in the way
- Self draining tank with integrated moulded sump connects to PVC 65mm, 100mm for 5000 & 9000 Ltr
- PVC pipe not included
- 10 degree sloping base
- 50mm Camlock with base & venturi set up
- Pumps to suit venturi system available

DIAGRAM

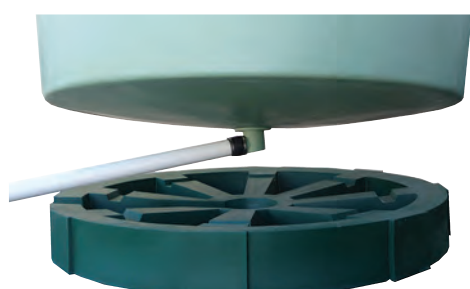
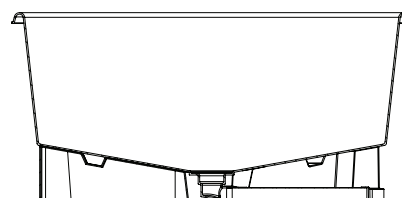

Aquaculture

Aquaculture Tanks

CODE	DESCRIPTION	DIMENSIONS	POLY RISER	FLOOR SLOPE ANGLE	WATER CONTROLLER KIT
FT200	200 ltr Flat Bottom Tank	800 DIA x 560 H			
FT500B	500 ltr Tank + Base	1000 DIA x 1000 H	APRS	80mm	WCK01
FT1000B	1,000 ltr Tank + Base	1040 DIA x 1200 H	APRS	40mm	WCK01
FT2000B	2,000 ltr Tank + Base	2140 DIA x 1000 H	APRS	150mm	WCK01
FT5000B	5,000 ltr Tank + Base	2850 DIA x 1180 H	APRS	120mm	WCK02
FT9000B	9,000 ltr Tank + Base	3500 DIA x 1280 H	APRS	100mm	WCK02
FTL2000	Lid to suit 2000L Tank	2180 DIA			

*Pump not included

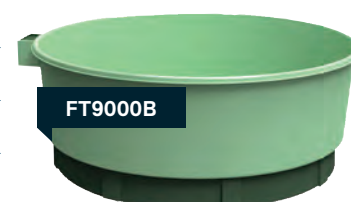

Accessories

Inspection Covers

CODE	DESCRIPTION
MHC1	Inspection Cover for 13,600ltr to 31,700ltr Tanks
MHC3	Water Entry Cover for Tanks with 400mm Sieve
MHC4	Inspection Cover for Tanks with 400mm Sieve
MHC5	Inspection Cover for RWT3300, RWT2270T and RWT1600 Tanks
MHC6	Inspection Cover for RWT1000, RWT600 and RWT200 Tanks
MHC8	Inspection Cover for Slimline Tanks 1050, 2000, 3000 and 5000ltr
MHC9	Inspection Cover for 600ltr Slimline Tank
MHCA	Manhole Cover Adapter - Black

Water Level Indicators

CODE	DESCRIPTION
CLG	Clock Level Gauge
DPK1	Dipstick
DPK1EXT	Dipstick Extension For 50KI Tank
LT01	Levetator - Water Level Indicator
LQ01	Liquidator - Level Indicator Suitable For Corrosive Liquids

Other Rainwater Accessories

CODE	DESCRIPTION
LGSO	Leaf Guard - Swivel Outlet
LWD	Downpipe Water Diverter
OFF9	90mm Overflow Flanged
OFP	Plug To Fit 90mm Overflow
OS9	90mm Overflow Screen
OFF10	100mm Overflow Flanged
PC01	Pump Cover 700L x 450W x 560H mm

Underground Tank Accessories

CODE	DESCRIPTION
JOS90	90mm Ozzie Seal For Overflow
URRM	500mm Riser - For Deeper Installations
URRM-SMALL	Riser - Underground Tank - Secondary Port Access Lid
URTL	Lid To Suit Underground Tanks
URTL-SMALL	Lid Only For Underground Tank HGR - Secondary Port Access Lid
R10112	Uniseal 100mm



MHC1



CLG



DPK1



LT01



PC01

Vortex Self-Cleaning Fine Filters

CODE	DESCRIPTION
URVF01	Vortex Filter Suitable For Roof Areas Up To 200Sq Metres
URVF15	Vortex Filter Suitable For Roof Areas Up To 500Sq Metres
URVF30	Vortex Filter Suitable For Roof Areas Up To 3000Sq Metres
URVFR	Riser Only - For Vortex Self Cleaning Filter
URVFWM	Vortex Filter Wall Mount



Tank Inlet Filter

CODE	DESCRIPTION
TIF3	Tank Inlet Filter 300mm including Sieve
TIF4	Tank Inlet Filter 400mm including Sieve



Sieves / Inlet Strainers

CODE	DESCRIPTION
S2	Sieve 200mm
S3	Sieve 300mm
S4	Sieve 400mm
S5	Sieve 500mm



Rural Fire Tank Fittings

CODE	DESCRIPTION
CFA1	65mm CFA Coupling Only (VIC)
CFA2	65mm CFA Coupling complete with 50mm (2") Outlet & Ball Valve
CFAC	Cap to suit CFA1
CFANT	65mm CFA Coupling nut and tail (VIC)
CFS1	65mm CFS Coupling Only (SA)
CFS2	65mm CFS Coupling (SA) Complete with 50mm (2") Outlet & Ball Valve
RFS	Rural Fire Service Fitting (NSW)
RFS2	RFS Coupling Complete (VIC Metro, NSW Rural)



Fittings for Pipeline Tanks

CODE	DESCRIPTION
AFV2L	25mm (1") plastic Sleeve Valve - Long Arm
AFV2LB	25mm (1") including 1.25" M & F Brass Outlet Plastic Sleeve Valve - Long Arm
IRS32	Internal raised Suction 32mm - suit 40mm outlet
IRS40	Internal raised Suction 40mm - suit 50mm outlet
PLTIP25	Pipeline Tank Internal Pipework 25mm
PLTIP40	Pipeline Tank Internal Pipework 40mm
PT2132	32mm (1 1/4") Dual Level reservoir valve
PT2140	40mm (1 1/2") Dual Level reservoir valve
PT2150	50mm (2") Dual Level reservoir valve
WV1	25mm (1") Watermark approved Float Valve
WV2	32mm (1 1/4") Watermark approved Float Valve
WV3	40mm (1 1/2") Watermark approved Float Valve



Stainless Steel Outlets

CODE	DESCRIPTION
LHO1SS	25mm M+F SS
LHO1.25SS	32mm M+F SS
LHO1.5SS	40mm M+F SS
LHO2SS	50mm M+F SS
LHO3SS	80MM M+F SS

Stainless Steel Ball Valves

CODE	DESCRIPTION
SSBV1	25mm SS
SSBV2	50mm SS
SSBV3	80mm SS
SC80-F	Camlock Type F 80mm BSP SS

*brass outlet not standard

Water Pumps

Household Pumps with Brass Rain/Mains Changeover Device

CODE	DESCRIPTION	WATTAGE	MAX FLOW (LPM)	POWER (kW)	INLET	OUTLET	WARRANTY
MHR20-370	Single Story Pump	370W	55	0.37	25mm BSPF	20mm BSPF	3 years
MHR20-550	Double Story Pump	550W	70	0.55	25mm BSPF	20mm BSPF	3 years

MHR20-370



MHR20-550



Submersible Pumps

CODE	DESCRIPTION	WATTAGE	MAX FLOW (LPM)	POWER (kW)	CABLE LENGTH	OUTLET	WARRANTY
HHR-370PC	Pump & Press Control	370W	115	0.75	5m	20mm BSPM	2 years
HHR-370S-PC	Pump & Water Switch	370W	82	0.5	5m	32mm BSPF	2 years

HHR-370PC



HHR-370S-PC



Garden Pumps with Press Control

CODE	WATTAGE	MAX FLOW (LPM)	POWER (kW)	INLET	OUTLET	WARRANTY
DHJ600	600W	45	0.6	25mm BSPF	25mm BSPM	2 years
DHJ800	800W	55	0.8	25mm BSPF	25mm BSPM	2 years
HSJ1000	1000W	85	1	25mm BSPF	25mm BSPM	3 years

DHJ600



DHJ800



HSJ1000



Pump Packages - Pump + Pump Cover

CODE	DESCRIPTION	WATTAGE	MAX FLOW (LPM)	POWER (kW)	INLET	OUTLET	WARRANTY	PUMP COVER (L x W x H)
PHGPS	Garden Pump with Press Control & Pump Cover	600W	45	0.6	25mm BSPF	25mm BSPM	2 years	700L x 450W x 560H mm
PH400	Household Pump With Brass Changeover Device & Pump Cover	370W	55	0.37	25mm BSPF	20mm BSPF	3 years	700L x 450W x 560H mm
PH550	Household Pump With Brass Changeover Device & Pump Cover	550W	70	0.55	25mm BSPF	20mm BSPF	3 years	700L x 450W x 560H mm

*Dimensions are approximate

PH400



PHGPS



Round Water Troughs

Master Tub Troughs



CODE	CAPACITY (Litres)	DIMENSIONS	FLOAT INLET	PRESSURE	DRAIN	DRAIN CAP	FLOAT COVER
MT2	200	970 DIA x 375H	25mm BSPM	140psi / 965 kPa	75	DC3	MTFC
MT6	600	1400 DIA x 520H	25mm BSPM	140psi / 965 kPa	75	DC3	MTFC
MT12	1,200	1765 DIA x 600H	25mm BSPM	140psi / 965 kPa	75	DC3	MTFC
MT24	2,400	2380 DIA x 650H	25mm BSPM	140psi / 965 kPa	75	DC3	MT05
MT45	4,500	3730 DIA x 650H	25mm BSPM	140psi / 965 kPa	75	DC3	MT04

KEY FEATURES

- Easy to service float valves
- Full float protection
- 75mm drain cap at very base of trough so maximum amount of water will empty when draining
- Easy to service 1" float valve
- Raised float allows trough to fill completely



Bare Round Water Troughs

CODE	CAPACITY (Litres)	DIMENSIONS	DRAIN	DRAIN CAP
PT12W	250	1000 DIA x 420H	75	DC3
PT10W	500	1200 DIA x 500H	75	DC3
PT11W	1,000	1650 DIA x 600H	75	DC3
PT13W	2,000	2100 DIA x 600H	75	DC3



Stock Water Tank & Trough

CODE	DESCRIPTION	CAPACITY	DIMENSIONS	FLOAT INLET	DRAIN	DRAIN CAP	FLOAT COVER
SWT4500	Tank & Trough Combination	4500ltr	2500 DIA x 2000H	25mm BSPM	75	DC3	SWTC
SWT15	Trough Only - inc Float Valve & Cover	1500ltr	2500 DIA x 375H	25mm BSPM	75	DC3	SWTC

KEY FEATURES

1. 25mm float valve mounted in bottom of wall to maintain level in trough
2. 75mm drain cap in trough
3. Inspection cover
4. 25mm tank inlet and 25mm float valve supplied
5. Full float cover to protect valve from stock damage
6. Inlet connection

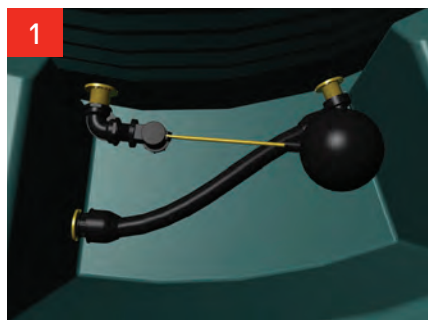

Long Water Troughs

Supa Troughs



CODE	DESCRIPTION	CAPACITY (Litres)	PRESSURE	DIMENSIONS (L x W x H)	FLOAT COVER	DRAIN CAP
SPT5	5 ft	250	140psi / 965 kPa	1500 x 600 x 375	SPTA	DC3
SPT9	9 ft	450	140psi / 965 kPa	2700 x 600 x 375	SPTA	DC3
SPT12	12 ft	600	140psi / 965 kPa	3700 x 600 x 375	SPTAL	DC3

KEY FEATURES

- One-piece trough incorporating float cover
- Long lasting UV resistant polyethylene
- Flexible and durable
- Raised cover allows trough to fill fully
- 25mm Float Valve & Cover + 75mm Bung each end



'M' Series Troughs

CODE	CAPACITY (Litres)	DIMENSIONS (L x W x H)	FLOAT COVER
PTM31W	140	2400 x 460 x 175	PTMFC
PTM32W	100	1800 x 460 x 175	PTMFC
PTM33W	60	1200 x 460 x 175	PTMFC
PTM34W	35	750 x 460 x 175	PTMFC

KEY FEATURES

- Long lasting UV resistant polyethylene
- Flexible and durable
- Stackable for storage
- Feed or water models available
- 15mm float valve and cover
- In built eyelets for securing to ground

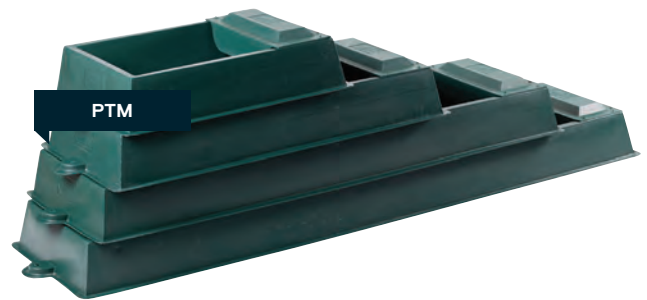

Sweep Ballast Troughs



CODE	DESCRIPTION	CAPACITY	DIMENSIONS (L x W x H)	FLOAT COVER	BROOM	DRAIN PLUG
SWP250	Trough with 25mm Float Valve	250 ltr	3492 x 580 x 350	SWP250FC	STB250	DP2
SWP250-40	Trough with 40mm Float Valve	250 ltr	3492 x 580 x 350	SWP250FC	STB250	DP2
SWP450	Trough with 25mm Float Valve	450 ltr	3495 x 772 x 375	SWP450FC	STB450	DP2
SWP450-40	Trough with 40mm Float Valve	450 ltr	3495 x 772 x 375	SWP450FC	STB450	DP2
SWP450-50	Trough with 50mm Float Valve	450 ltr	3495 x 772 x 375	SWP450FC	STB450	DP2

KEY FEATURES

- Easy cleaning - smooth sweep out end
- Flexible and durable
- Hinged float cover prevents any damage to inlet
- Tough double skin unit for extra strength
- 50mm Drain Plug
- Contoured brooms available for easy sweep out cleaning

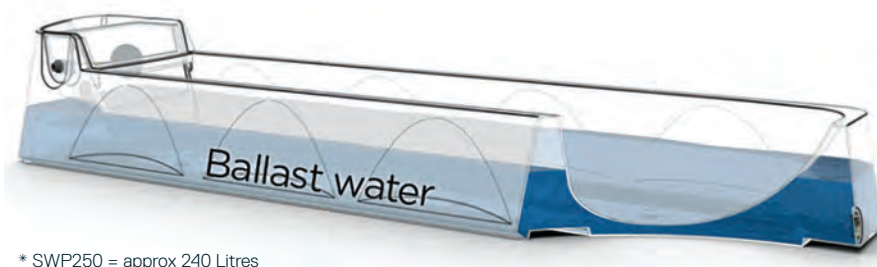

* SWP250 = approx 240 Litres
SWP450 = approx 300 Litres



Polychoice Troughs



CODE	PROFILE	CAPACITY (Litres)	DIMENSIONS (L x W x H)	FLOAT INLET	PRESSURE	DRAIN	DRAIN PLUG
PCTL12	Long	160	1200 x 600 x 375	25 BSPM	150psi / 1034kPa	50	DP2
PCTL24	Long	360	2400 x 600 x 375	25 BSPM	150psi / 1034kPa	50	DP2
PCTR22	Round	220	1000 DIA x 400H	25 BSPM	150psi / 1034kPa	50	DP2
PCTR66	Round	660	1500 DIA x 500H	25 BSPM	150psi / 1034kPa	50	DP2
PCTR120	Round	1,200	1900 DIA x 530H	25 BSPM	150psi / 1034kPa	50	DP2

KEY FEATURES

- Enclosed float compartment
- Stackable
- Flexible & Durable
- 25mm Float Valve



Feed Troughs

Calf Feeding - Dry Feed Troughs

CODE	CAPACITY	DIMENSIONS (L x W x H)	POLY INSERT
PTC36F	68kg	2400 x 300 x 600	PTC36I
PTC37F	52kg	1800 x 300 x 600	PTC37I

KEY FEATURES

- Galvanised frames with splayed legs for greater stability.
- Provision for pegging down



'M' Series Troughs

CODE	CAPACITY (Litres)	DIMENSIONS (L x W x H)
PTM31F	140	2400 x 460 x 185
PTM32F	100	1800 x 460 x 185
PTM33F	60	1200 x 460 x 185
PTM34F	35	750 x 460 x 185

KEY FEATURES

- Long lasting UV resistant polyethylene
- Flexible and durable
- Stackable for storage
- Feed or water models available
- In built eyelets for securing to ground



Molasses Feeder

CODE	DESCRIPTION	DIMENSIONS (L x W x H)
PT05	Licker Drum 100 ltr	800 X 700 X 425
PT05C	Case only	
PT05R	Roller only	

KEY FEATURES

- Urea feeding and bloat control
- Removable roller for cleaning
- Floating roller - no metal bearings

***Caution:** Special care should be taken when administering urea and other supplements, excess consumption can cause death

Continuous Dry Feed Trough

CODE	DESCRIPTION	DIMENSIONS (L x W x H)	ANCHORING PEGS (6 pack)
CFT8	No Ends	2320 x 230 x 85	FTP9
CFT8E	Ends Both Sides	2320 x 230 x 85	



Footrot Baths

Standing Type



CODE	DIMENSIONS (L x W x H)	CAPACITY (Max Litres)
FRB	2530 x 1000 x 200	300

KEY FEATURES

- Control hoof diseases in sheep and goats
- Use with portable yard to keep animals confined
- Lightweight for ease of handling
- Non slip dimpled floor
- End to end linking feature
- Will not rot, rust or flake and fully chemical resistant



*Not recommended for cattle and horses

Race Type

CODE	DIMENSIONS (L x W x H)	CAPACITY (Max Litres)
RFRB	2400 x 480 x 200	80

KEY FEATURES

- Control hoof diseases in sheep and goats
- Unique pyramid shaped rib through centre of trough
- Keep hooves either side of the trough
- Added strength and support to trough floor
- Reduce amount of solution needed to treat stock
- Non slip dimpled floor
- End to end linking feature is ideal for placing in sheep race
- Will not rot, rust or flake and fully chemical resistant

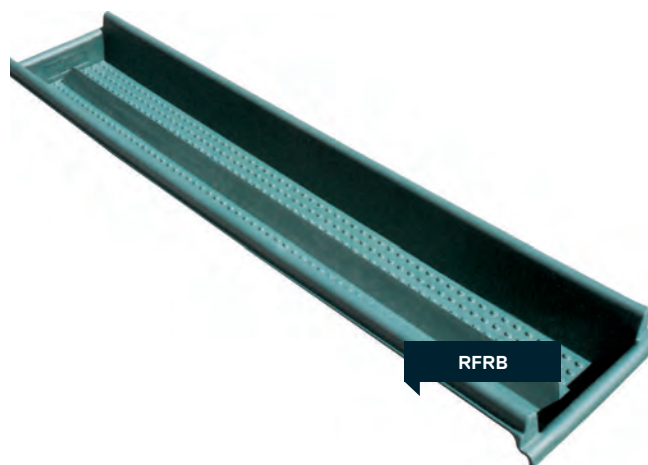

*Not recommended for cattle and horses

Trough Spares

Float Valves

CODE	DESCRIPTION
AFV2	25mm (1") Plastic Sleeve Valve to suit Supa Troughs, Master Tubs and Longline Troughs Pressure range 0 - 965kpa (0 - 140psi)
AFV2SEAL	Float Valve Seal AFV2
AFV3B	32mm (1¼") Plastic Sleeve Valve - High Volume incl 40mm (1½") M & F Brass outlet. Pressure range 0 - 450kpa (0 - 65psi)
AFV4B	40mm (1½") Plastic Sleeve Valve - High Volume incl 50mm (2") M & F Brass Outlet. Pressure range 0 - 450kpa (0 - 65psi)
AFV5B	50mm (2") Plastic Sleeve Valve - High Volume incl 2½" M & F Brass Outlet. Pressure range 0 - 450kpa (0 - 65psi)
AFV6	25mm (1") Plastic piston valve to suit MT2, MT6 (fitted prior to May 2009) Pressure range 0 - 1400kpa (0 - 200psi)
AFV6L	25mm piston valve long arm 1400KPA rating
AFV0L	15mm (1/2") Philmac Float Valve - Long Arm For PT49W, PT50W & M Troughs
JFV20	20mm Jobe Float Valve for PolyChoice Troughs Pressure range 0 - 1034kpa (0 - 150psi)

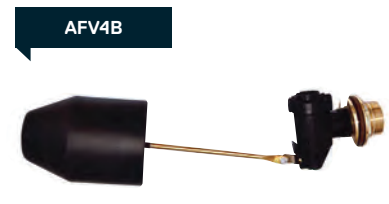

Drain Caps & Plugs

CODE	DESCRIPTION
DC2	50mm (2") Drain Cap for all longline troughs, PT49W & PT50W
DCSE	Seals only for 50mm (2") Drain Cap
DC3	75mm (3") Drain Cap
DC3SE	Seals only for 75mm (3") Drain Cap
DP2	50mm (2") Drain Plug
DPSE	Seals only for 50mm (2") Drain Plug
DP4B	100mm (4") Brass drain plug to suit MT45 only



Float Covers

CODE	SUITS
PTMFC	PTM31W, PTM32W, PTM33W, PTM34W
MTFC	MT2, MT6, MT12
SWTC	SWT4500, SWT15
SPTA	SPT5, SPT9
SPTAL	SPT12
SWP250FC	SWP250, SWP250-40, SWP250-50
SWP450FC	SWP450, SWP450-40, SWP450-50



Calf Milk Feeders



CODE	DESCRIPTION	CAPACITY (Litres)	DIMENSIONS (L x W x H)	BRACKETS & MOUNTS	TEAT & CAP	TEAT													
MBP	Single Teat Milk Bottle	2	100 x 180 x 250		PCT/SCIT	PCT													
MM1P	Single Teat Feeder	5	200 x 200 x 300		PCT/SCIT	PCT													
MM5P	5 Teat Feeder - Divisional	30	270 x 760 x 300	MM5BR	PCT/SCIT	PCT													
MM8P	8 Teat Feeder - Divisional	40	MM12BR	PCT/SCIT	PCT	MM12P	12 Teat Feeder - Divisional	70	540 x 1260 x 320	MM12BR	PCT/SCIT	PCT	MM13P	13 Teat Feeder - Divisional	70	280 x 1800 x 330	MM12BR	PCT/SCIT	PCT
MM12P	12 Teat Feeder - Divisional	70	540 x 1260 x 320	MM12BR	PCT/SCIT	PCT													
MM13P	13 Teat Feeder - Divisional	70	280 x 1800 x 330	MM12BR	PCT/SCIT	PCT													

KEY FEATURES

- Generous spacing between teats
- Teat caps easily unscrew to wash out feeder
- Galvanised hanging brackets to suit rail spacing
- UV stabilised poly for long outdoor use

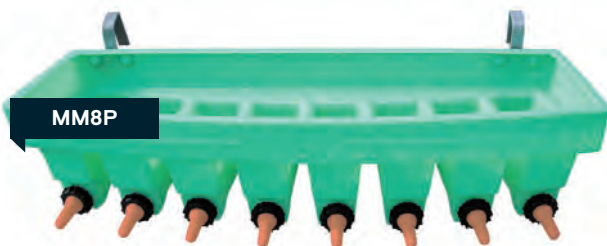
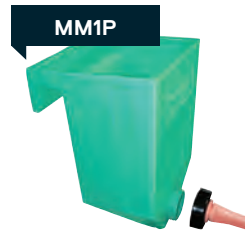

Lamb Milk Feeders

CODE	DESCRIPTION	CAPACITY (Litres)	DIMENSIONS (L x W x H)	BRACKETS & MOUNTS	TEATS & CAPS	TEATS
FLBF	Clear Single Teat Milk Feeders	1	80 x 80 x 300		LT/BC	LT
MBL	Single Teat Milk Bottle	2	100 x 180 x 250		LT/SC	LT
MM1L	Single Teat Feeder	5	200 x 200 x 300		LT/SC	LT
MM5L	5 Teat Feeder - Divisional	30	270 x 760 x 300	MM5BR	LT/SC	LT
MM8L	8 Teat Feeder - Divisional	40	MM12BR	LT/SC	LT	
MM12L	12 Teat Feeder - Divisional	70	540 x 1260 x 320	MM12BR	LT/SC	LT
MM13L	13 Teat Feeder - Divisional	70	280 x 1800 x 330	MM12BR	LT/SC	LT

KEY FEATURES

- Generous spacing between teats
- Teat caps easily unscrew to wash out feeder
- Galvanised hanging brackets to suit rail spacing
- UV stabilised poly for long outdoor use



Milk Test Buckets

CODE	CAPACITY (Litres)	DIMENSIONS	SEAL	LID & SEAL
PTB25	25	300 DIA x 490H	PTBS	PTBL25
PTB32	32	330 DIA x 510H	PTBS	PTBL32

KEY FEATURES

- Stainless steel handles
- Replacement Seals Available
- Pipe attachments to suit 5/8" or 3/4" tubing



Mobile Gravity Milk Feeders



CODE	DESCRIPTION	CAPACITY	DIMENSIONS (L x W x H)	MANIFOLD
MG40P	40 Teat Feeder - single axle	400 ltr	2200 x 1500 x 1200	MG4M
MG50P	50 Teat Feeder - single axle	400 ltr	2800 x 1500 x 1200	MG5M
MG50TAP	50 Teat Feeder - dual axle	400 ltr	2800 x 1500 x 1200	MG5M
MG50LTAP	50 Teat Feeder - dual axle	800 ltr	2800 x 1500 x 1200	MG5M
MG60P	60 Teat Feeder - dual axle	800 ltr	3100 x 1550 x 1500	MG6M
MG400T	400 ltr (tank only)	400 ltr		
MG800T	800 ltr (tank only)	800 ltr		



Mobile Mixer and Tanker

CODE	DESCRIPTION	DIMENSIONS (L x W x H)
MMT400	400 ltr - 2.5HP Pump	2200 x 1500 x 1200



Riverina Milk Transporter

CODE	DESCRIPTION	DIMENSIONS (L x W x H)
RMT	200 ltr - single axle	1700 x 1200 x 1000



KEY FEATURES

- Fully hot dipped galvanised trailers
- Screw on teats can be replaced with blanks
- Adjustable fold away jockey wheel
- Built in backwash for all trailer units
- Self cleaning washing head used in tank
- Large hinged filling lids

Fence & Stable Drinkers



CODE	FENCE BRACKETS	CAPACITY (Litres)	DIMENSIONS (L x W x H)	BRACKETS & MOUNTS	DRAIN CAP
PT48W	-	8	300 x 300 x 224	PT14BR	PT04WC
PT48WB	Yes	8	300 x 300 x 224	PT14BR	PT04WC
PT49W	-	25	440 x 380 x 350	PT49BRS	DC2
PT49WB	Yes	25	440 x 380 x 350	PT49BR	DC2
PT50W	-	45	490 x 430 x 440	PT49BRS	DC2
PT50WB	Yes	45	490 x 430 x 440	PT49BRS	DC2
PT90W	Yes	90	550 x 1090 x 400	PT90BRS	DC2

KEY FEATURES

- Drain cap for easy cleaning
- Fix directly to the wall or brackets available for fence hanging
- Stylish colours available



Fence & Stable Feeders

CODE	DESCRIPTION	CAPACITY (Litres)	DIMENSIONS (L x W x H)	BRACKETS & MOUNTS
PT02	Fitted with fence brackets	45	540 x 410 x 380	PT49BRS
PT02FS	Fitted with wall mount brackets	45	540 x 410 x 380	PT02STBR
PT03	Hayrack (suitable to hang on fence)		600 x 500 x 700	PT03R
PT14	Fence Feeder 'D' Type	32	440 x 400 x 250	PT14BR
PT15	Corner Feeder	32	450 x 450 x 270	PT14BR
PTF18	Tyre Feeder	18	350 DIA x 195H	

COLOUR RANGE



Teats & Accessories

Accessories

CODE	DESCRIPTION
HL4	Hinged Lid 400mm for All MG40, MG50 & MG60 Calf Feeders
JWK	Jockey Wheel Kit - to suit Mobile Gravity Calf Feeder
MG2W	16" Wheel only for MG26 Calf Feeder (no axle)
MG4W	18" Wheel only for MG40, MM50, MG50 & Calf Feeder (no axle) each
MG4M	20 Teat manifold for MG40 Calf Feeder (Specify front or rear)
MG5M	25 Teat manifold for MG50 Calf Feeder (Specify front or rear)
MG6M	30 Teat manifold for MG60 Calf Feeder (Specify front or rear)
MGD1	Mud guards for single wheel calf feeders (Set of 2)
MGD2	Mud guards for tandem wheel calf feeders (Set of 2)
SL5	Screw lid - complete 355mm (suits RMT)



HL4



LT/BC



LT/SC



PCT/SCIT

Brackets

CODE	DESCRIPTION
MM5BR	Brackets to suit MM5 and CF5 (Set of 2)
MM12BR	Brackets to suit MM8, MM12, MM13, CF12 & CF13 (Set of 2)
PT14BR	Set of Brackets to suit Fence Feeders PT14, PT15, PT48WB
PT49BR	Set of Brackets to suit PT49WB, PT50WB & PT02
PT02STBR	Set of wall Mount Brackets to suit PT02FS
PT03R	Galvanised Rack to suit PT03 Hayrack (Set of 2)

Accessories

CODE	DESCRIPTION
PTWK7	Spacesaver 15mm (½") piston valve for PT48W (Pressure range 0 - 850kpa (0 - 120psi))

Teats and Caps

CODE	DESCRIPTION
PCT	Peach Teats
SCITP	Screw Cap with internal thread for Peach Teats
PCT/SC	Peach Calf Teat pulled through Screw Cap
LT	Lamb Teat
LT/BC	Lamb Teat through Bottle Cap
LT/SC	Lamb Teat through Screw Cap
SCL	Screw Caps for Lamb Teats
SCP	Screw Cap for Peach Teat

Drain Caps

CODE	DESCRIPTION
PT04WC	25mm (1") Drain Cap for PT48W Drinkers
DC2	50mm (2") Drain Cap for PT49W & PT50W Drinkers
DCSE	Seals only for 50mm (2") Drain Cap

Milk Transfer Pump Kit

CODE	DESCRIPTION	FLOW (LPM)
MTP110	Milk Transfer Submersible pump kit 12V	40



MTP110

Farm Storage & Equipment

Feed Storage Bin

CODE	DESCRIPTION	DIMENSIONS (L x W x H)
FSB200	Feed Storage Bin 200 ltr - Hinged Lid	520 x 860 x 560



FSB200

Handi Steps

CODE	DESCRIPTION	DIMENSIONS (L x W x H)
HSP	120kg SWL	700 x 520 x 670



HSP

Buckets

CODE	VOLUME
POB20	20 ltr with level measurements



POB20

Feed Scoops

CODE	VOLUME
PSC	2.5kg of pellets



PSC

COLOUR RANGE







KEY FEATURES

- Available in a range of stylish colours
- Large capacity
- Sturdy handles
- Stackable

Farm Storage & Equipment



Shovel

CODE	DESCRIPTION	DIMENSIONS	COLOUR RANGE		
GS40	Grain Shovel	1100 H	 RED	 GREEN	 BLUE
			 WHITE	 YEL	



Grain Hopper

CODE	DESCRIPTION	DIMENSIONS (L x W x H)
GAB2	Grain Hopper (Auger Boot) Fits 4-10 inch-Auger	1100 x 1200 x 650

KEY FEATURES

- Wide support base and low profile
- Suits augers upto 250mm (10")
- Crease resistant - flexes back into shape
- Equipped with strap to hold onto auger



Dog Houses

CODE	DESCRIPTION	DIMENSIONS (L x W x H)	OPENING SIZE
TDD1	Dinkum Doghouse 1	1050 x 780 x 690	390 DIA
TDD3	Log Cabin Doghouse	1060 x 860 x 780	280 x 400

KEY FEATURES

- Cooler in summer, warmer in winter
- Rear venting to create airflow
- Hygenic - easily washed out

COLOUR RANGE

*TDD1 Only

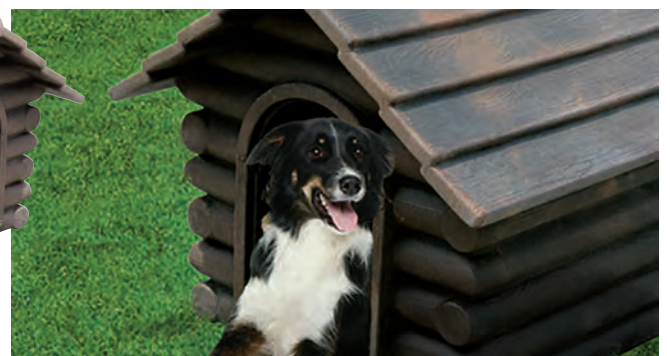
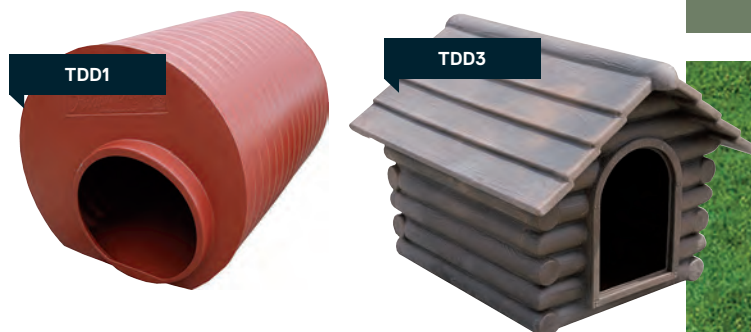
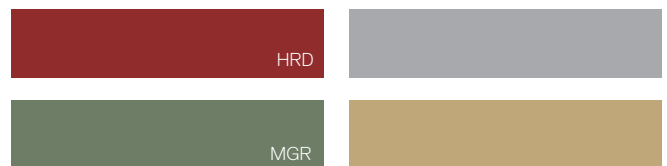

Produce Bins & Liners



CODE	DESCRIPTION	CAPACITY (Litres)	DIMENSIONS (L x W x H)	LID
PPB100	Produce Bin	1,000	1190 x 1190 x 1010	PPBL
PPB100FC	Produce Bin incl fork plates	1,000	1190 x 1190 x 1010	PPBL
PBL85	Liner Only	850	1110 x 1110 x 760	PBLD
PBL100	Liner Only	1,000	1110 x 1110 x 885	PBLD
PBL145	Liner Only	1,450	1110 x 1110 x 1200	PBLD
GBL	Grape Bin Liner	2,850	2170 x 1200 x 1100	GBLLIDN

KEY FEATURES - PPB100

- Stackable when full, nest them empty
- Optimum height for hand picking
- FEA analysis testing completed for strength
- Ideal pallet size for transporting
- Forklift access channels
- Food grade polyethylene

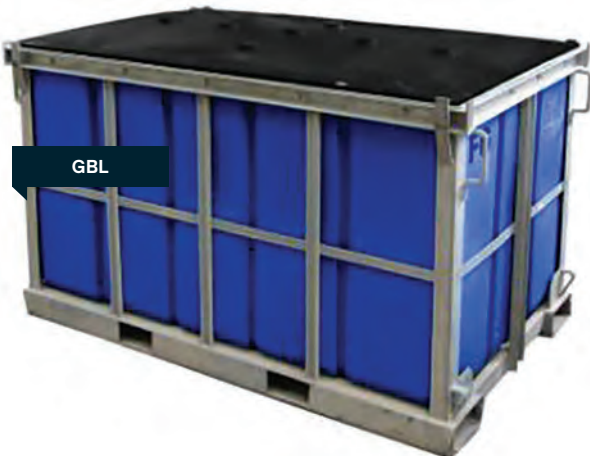

*Steel frames not included, only shown for illustrative purposes

Bulk Storage

Bulka Bins



CODE	DESCRIPTION	CAPACITY (M ³)	DIMENSIONS (L x W x H)	LID
BB12	Galvanised frame	1.2	1200 x 1500 x 1600	BBLID
BB12XL	Galvanised frame - extended legs	1.2	1200 x 1500 x 2300	BBLID
BB16	Galvanised frame	1.6	1200 x 1500 x 1860	BBLID
BB16XL	Galvanised frame - extended legs	1.6	1200 x 1500 x 2560	BBLID

PRODUCT	BB12	BB16
Wheat & Meatmeal	960kg	1200kg
Barley	750kg	1000kg
Oats	600kg	800kg
Urea	876kg	1200kg
Lucerne	300kg	400kg
Calf & Pig Pellets	800kg	1050kg

KEY FEATURES

- All galvanised forklift frame - lifts on/off easily
- Stainless steel chute with rodent and weather resistant outlet
- Extended leg models allow for bag filling
- Suitable for grains, pellets and more



Maxi Bins

DRY OUTLET	LIQUID OUTLET	CAPACITY (M ³)	DIMENSIONS (L x W x H)
MB60P	MB60L	0.6	1165 x 1165 x 1450
MB100P	MB100L	1.0	1165 x 1165 x 1870
MB150P	MB150L	1.5	1165 x 1165 x 2235
MB200P	MB200L	2.0	1165 x 1165 x 2655



Silomaster



DRY OUTLET	LIQUID OUTLET	CAPACITY (Litres)	DIMENSIONS
SM5000D	SM5000L	5,000	2380DIA x 3030H
SM7500D	SM7500L	7,500	2380DIA x 3620H
SM10000D	SM10000L	10,000	2380DIA x 4210H



Silomaster - Heavy Duty

DRY OUTLET	LIQUID OUTLET	CAPACITY (Litres)	DIMENSIONS
SM5000HDD	SM5000HDL	5,000	2380DIA x 3530H
SM7500HDD	SM7500HDL	7,500	2380DIA x 4115H
SM10000HDD	SM10000HDL	10,000	2380DIA x 4705H

*Suitable to hold liquids up to 1.4SG

KEY FEATURES

- Sturdy galvanised steel frame and rust proof poly tank
- Integrated forklift channels
- Rodent and weather proof
- Screw lid

COLOUR RANGE



Dry Feed Frame

CODE	CAPACITY (Litres)	DIMENSIONS
SMDF5000	5,000	2380DIA x 3525H
SMDF7500	7,500	2380DIA x 4115H
SMDF10000	10,000	2380DIA x 4705H



Silomaster Large Capacity



CODE	CAPACITY (Litres)	DIMENSIONS
SM20000L	20,000	3450DIA x 4376H
SM25000L	25,000	3450DIA x 4923H
SM30000L	30,000	3450DIA x 5471H

KEY FEATURES

- Sturdy galvanised steel frame and rust proof poly tank
- Integrated forklift channels
- Rodent and weather proof
- Screw lid
- 100mm 90 deg fitting

COLOUR RANGE



AGRICULTURE

Vehicle Storage

Vehicle Water Tanks



CODE	DESCRIPTION	CAPACITY (Litres)	DIMENSIONS (L x W x H)
HT28	Handi Tank only	28	415 x 240 x 380
HT28P	Handi Tank with mounting plate	28	415 x 240 x 380

KEY FEATURES

- 20mm tap for dispensing
- 20mm cap at top for easy filling

COLOUR RANGE



Tool Boxes

CODE	DESCRIPTION	CAPACITY (Litres)	DIMENSIONS (L x W x H)
BUC14	B'Ute Tool Box - Small	140	970 x 400 x 360
BUC26	B'Ute Tool Box - Large	266	1170 x 570 x 400
TBC20	Tradesman Box	200	980 x 390 x 600
TBC20FH	Tradesman Box Friction Hinge	200	980 x 390 x 600

KEY FEATURES

- Flush mounted zinc hardware
- Raised weather resistant lid seal
- Removable internal tray included

COLOUR RANGE



Diesel Ute Packs

Diesel Essential Ute Packs



CODE	CAPACITY (Litres)	DIMENSIONS (L x W x H)	PUMP*	PUMP FLOW (LPM)	HOSE LENGTH (m)	AUTO TRIGGER NOZZLE
DMP100E	100	770 x 540 x 500	DP50PUMP	50	4	Yes
DMP200E	200	1000 x 750 x 605	DP50PUMP	50	4	Yes
DMP400E	400	1620 x 750 x 665	DP50PUMP	50	4	Yes
DMPQ400E	400	930 x 1200 x 685	DP50PUMP	50	4	Yes
DMP600E	600	1720 x 890 x 755	DP50PUMP	50	4	Yes
DMP800E	800	1720 x 890 x 925	DP50PUMP	50	4	Yes

*Refer to Diesel Pump page for full pump details

KEY FEATURES

- 50LPM Italian Piusi pump
- Lockable lid
- UV protected
- Earth strap
- Isolation switch
- 4m Diesel hose
- Diesel auto trigger nozzle
- Alligator clips
- Vented fill cap

OPTIONAL EXTRAS

- Gas Struts - Only available on cube ute packs
- Fuel Gauge
- Bund available - cube ute packs



Diesel Transfer Tanks

Transfer Tank & 12V Pump (up to 50LPM)

CODE	CAPACITY (Litres)	DIMENSIONS (L x W x H)	VOLTAGE	POWER (kW)	PUMP CODE	FLOW (LPM)
DMP1200	1200	1450 x 1200 x 1000	12	0.3	DP50PUMP12V-ASY	50
DMP2000	2000	1900 x 1450 x 1100	12	0.3	DP50PUMP12V-ASY	50
DMP3000	3000	2100 x 1500 x 1200	12	0.3	DP50PUMP12V-ASY	50

Transfer Tank & Fastflow 12V Pump (up to 85LPM)

CODE	CAPACITY (Litres)	DIMENSIONS (L x W x H)	VOLTAGE	POWER (kW)	PUMP CODE	FLOW (LPM)
DMPF1200	1200	1450 x 1200 x 1000	12	0.5	DP85PUMP12V	85
DMPF2000	2000	1900 x 1450 x 1100	12	0.5	DP85PUMP12V	85
DMPF3000	3000	2100 x 1500 x 1200	12	0.5	DP85PUMP12V	85

Transfer Tank & 24/12V Pump (70/35LPM)

CODE	CAPACITY (Litres)	DIMENSIONS (L x W x H)	VOLTAGE	POWER (kW)	PUMP CODE	FLOW (LPM)
DMPD1200	1200	1450 x 1200 x 1000	12/24	0.42/0.15	DP1224PUMP12V	70/35
DMPD2000	2000	1900 x 1450 x 1100	12/24	0.42/0.15	DP1224PUMP12V	70/35
DMPD3000	3000	2100 x 1500 x 1200	12/24	0.42/0.15	DP1224PUMP12V	70/35

Transfer Tank & 240V Pump (100LPM)

CODE	CAPACITY (Litres)	DIMENSIONS (L x W x H)	VOLTAGE	POWER (kW)	PUMP CODE	FLOW (LPM)
DMP1200-240V	1200	1450 x 1200 x 1000	240	750	DP100-240V	100
DMP2000-240V	2000	1900 x 1450 x 1100	240	750	DP100-240V	100
DMP3000-240V	3000	2100 x 1500 x 1200	240	750	DP100-240V	100

Bare Tank

CODE	CAPACITY (Litres)	DIMENSIONS (L x W x H)	SKIDS
DM1200	1200	1450 x 1200 x 1000	SKD1200
DM2000	2000	1900 x 1450 x 1100	SKD2000
DM3000	3000	2100 x 1500 x 1200	SKD3000



KEY FEATURES

- High quality Piusi Italian pump
- Lockable filling port
- Auto trigger nozzle and swivel
- Stainless steel pin mounting feet to secure to trailer or flat bed
- 4 metre Diesel hose and leads
- *Refer to Diesel Pump page for full pump details

Diesel Trailer Packages



CODE	CAPACITY (Litres)	TANK DIMENSIONS (L x W x H)	TRAILER DIMENSIONS (L x W x H)	PUMP*	PUMP FLOW LPM	HOSE LENGTH (m)	AUTO TRIGGER NOZZLE
DMPFT1200	1200	1450 x 1200 x 1000	3940 x 1770 x 1500	DP85PUMP	85	6	Yes
DMPFT2000	2000	1900 x 1450 x 1200	4460 x 1970 x 1650	DP85PUMP	85	6	Yes

KEY FEATURES - TRAILER

- Hot dip galvanised dual axle trailer
- 5 Stud Wheel Pattern
- Electric brakes - 2000ltr
- Hydraulic brakes - 1200ltr
- Road pack including brakes and LED lights
- Emergency breakaway protection
- Compliance plate - road registrable

KEY FEATURES - TANK AND PUMP

- 85LPM 12V Diesel pump with by-pass valve and integrated on/off switch
- Auto shut off nozzle with 6m hose and reel
- 4m battery leads
- Breather vent
- 400mm 1/4 turn hinged lid
- Trailer mounted toolbox to protect the hose, pump and nozzle
- *Refer to Diesel Pump page for full pump details

DMPFT1200T



Optional 10m retractable Diesel hose reel



Diesel Single Skin Smooth Wall Tanks



CODE	CAPACITY (Litres)	DIMENSIONS
DSW5000LGY	5,000	1800 DIA x 2300 H
DSW7000LGY	7,000	2200 DIA x 2300 H
DSW10000LGY	10,000	2480 DIA x 2450 H

KEY FEATURES

- Clock Type Level Gauge Option to upgrade
- Galvanised Pipe work
- 2" Aluminium Cam Lock
- 2" Brass Outlet and Ball Valve
- Earth Rod
- Breather Vent
- Australian Made
- Fill rate maximum 250LPM
- Overfill protection

* NOTE: Please seek advice of local authorities for positioning on site

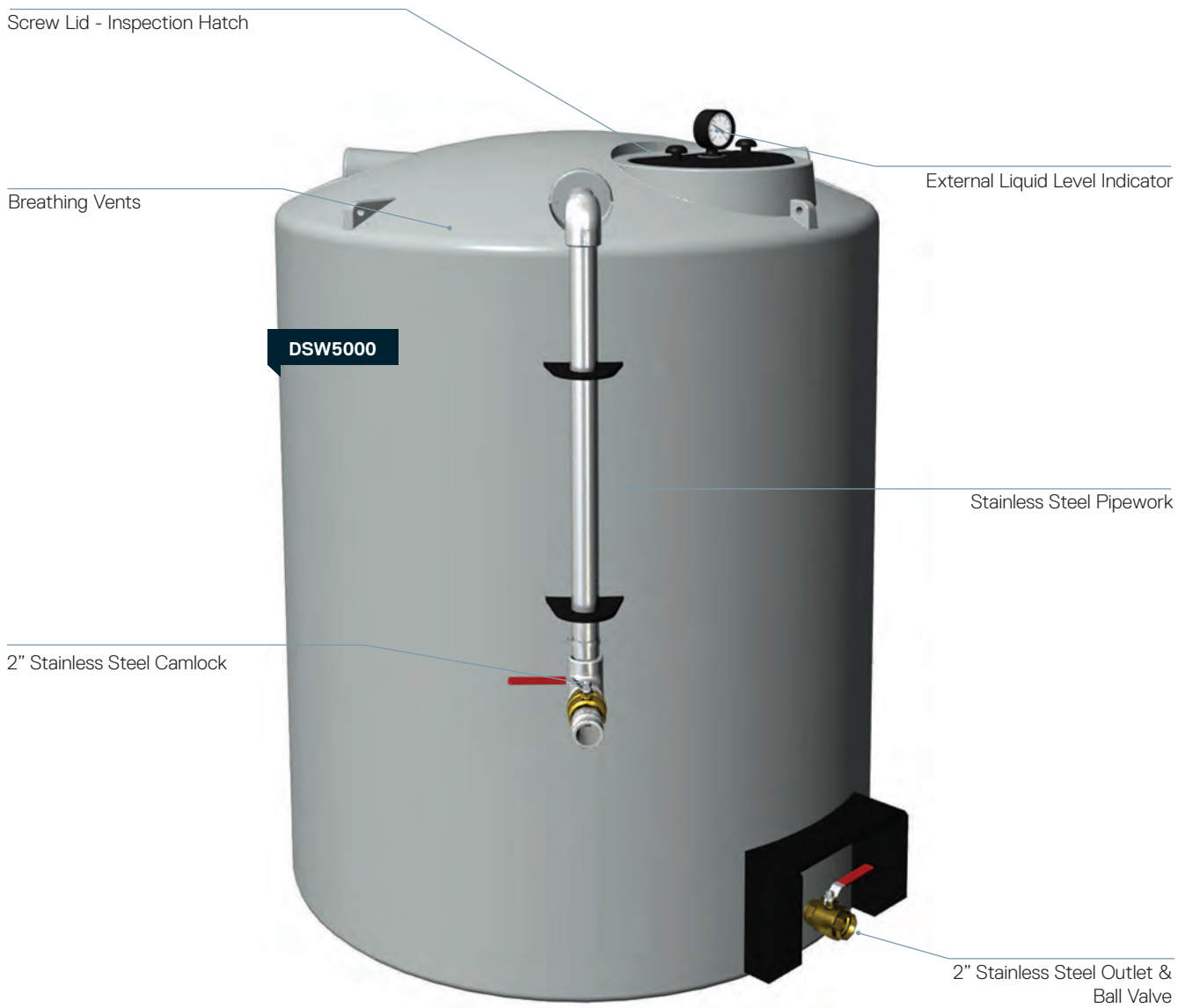

Diesel Self Bunded Tank

Three models available: Essential, Ranger or Quantum

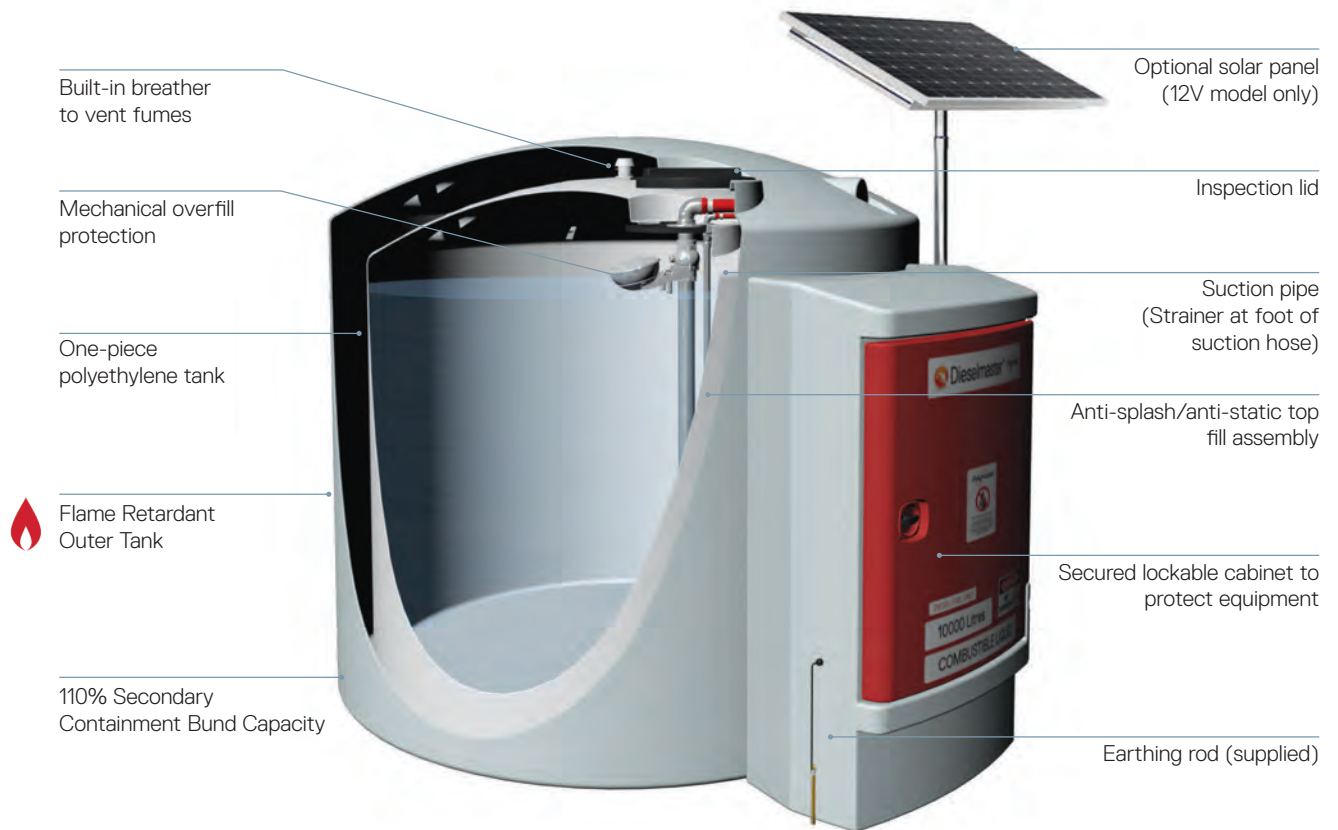

Cabinet Details (Essential Model Shown)

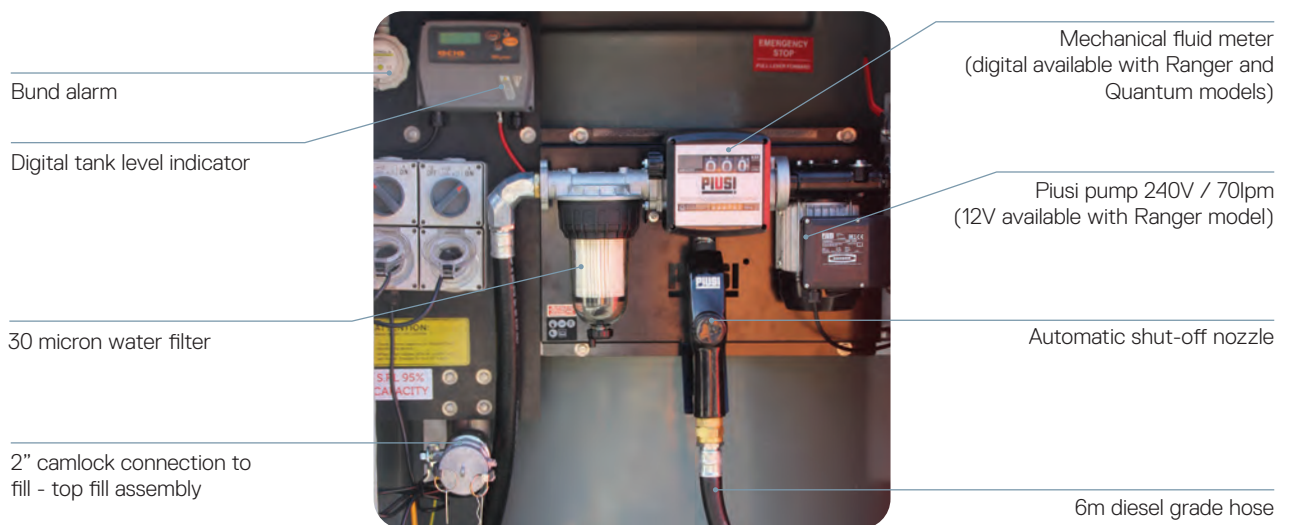

(Image for illustrative purposes only)

FEATURES	ESSENTIAL	RANGER	QUANTUM
Power supply - 240V	✓	✓	✓
Power supply - 12V	-	✓	-
70LPM Piusi pump	✓	✓	✓
6mtr dispensing hose with auto-shut off trigger nozzle	✓	✓	-
10mtr hose reel with auto-shutoff trigger nozzle	-	-	✓
Auto-shutoff nozzle holster	-	✓	✓
30 micron clear water capture filter - to 150LPM	✓	✓	✓
2" camlock connection to fill - top fill assembly	✓	✓	✓
Anti-splash/anti-static top fill assembly	✓	✓	✓
Mechanical overfill protection	✓	✓	✓
High/Low level electronic audible alarm	-	✓	✓
Bund alarm	✓	✓	✓
110% secondary containment bund capacity	✓	✓	✓
Flame retardant outer tank material	✓	✓	✓
Digital level indicator	✓	✓	✓
Secured lockable cabinet to protect equipment	✓	✓	✓
Mechanical fluid meter to measure vehicle usage	✓	-	-
Digital fluid meter to measure vehicle usage	-	✓	✓
Power control box with auto time out (10mins) & emergency stop	-	✓	✓
Fuel management system for up to 120 users	-	-	✓

Specifications

CODE	CAPACITY (Litres)	A	B	C	D
DMDS2300	2,300	1600	2160	2200	2120
DMDS3300	3,300	1800	2130	2200	2300
DMDS5000	5,000	2200	2080	2260	2750
DMDS7000	7,000	2500	2190	2350	3070
DMDS10000	10,000	2500	2520	2710	3062

DIMENSIONS

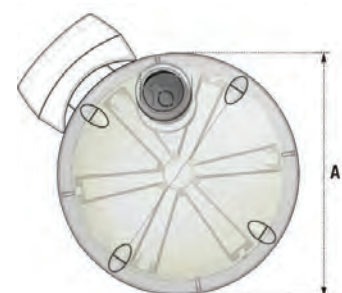
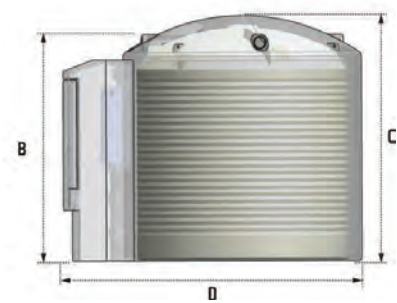

Diesel Dispensing Units

Piisi ST Meter

CODE	FLOW RATE (LPM)	VOLTAGE	METER	NOZZLE	HOSE LENGTH (m)	HOSE DIAMETER	OUTLET (BSP)
STMETER240V	72	240v	K33	A80	4	25	25
STMETER12V	56	12v	K33	A80	4	20	20

KEY FEATURES

- Ready to use
- Easy to install
- Sturdy structure
- High precision meter
- Available with both 12v or 240v pumps



Piisi ST Box

CODE	FLOW RATE (LPM)	VOLTAGE	METER	NOZZLE	HOSE LENGTH (m)	HOSE DIAMETER	OUTLET (BSP)
STBOXMETER12V	80	12v	K33	A80	4	25	25
STBOXBASIC	70	240v	K33	A80	6	25	20
STBOXPRO	70	240v	A80	Auto	6	25	25

- Sturdy structure
- Lockable and safe
- Ready to use
- Filtration guaranteed
- Auto Shut-off Nozzle Holster

STBOXPRO



STBOXBASIC



Piisi Cube

CODE	FLOW RATE (LPM)	VOLTAGE	METER	NOZZLE	HOSE LENGTH (m)	HOSE DIAMETER	OUTLET (BSP)
CUBE56-12V	56	12v	K33	A60	4	25	25
CUBE70-240V	70	240v	K33	A60	6	25	20

KEY FEATURES

- Sturdy structure
- Mechanical meter
- Induction thermal-protected motor
- Overload protection
- Built-in mesh filter



CUBE56-12V

Diesel Pumps & Accessories

Diesel Pumps

CODE	DESCRIPTION	VOLTAGE	POWER (kW)	FLOW (LPM)	INLET	OUTLET	WARRANTY (yrs)	KIT
DP50PUMP12V-ASY	50Lpm Diesel Pump	12v	0.3	50	25mm	25mm	1	DP50K
DP72PUMP	72Lpm Diesel Pump	240v	0.5	72	25mm	25mm	1	DP72K
DP85PUMP	85Lpm Diesel Pump Fast Flow	12v	0.5	85	25mm	25mm	1	DP80K
DP1224PUMP	70/35Lpm Diesel Pump Dual Voltage	12v/24v	0.42/0.15	70/35	25mm	25mm	1	DP3570K

Pump Kits

CODE	CONTENTS
DP50K	Pump, 4m Hose & Automatic Shutoff Nozzle
DP72KA	Pump, Mechanical Meter, Water Capture Filter, 6m Hose, Automatic Shutoff Nozzle
DP85K	Pump, 4m Hose, Automatic Shutoff Nozzle
DP1224K	Pump, 4m Hose, Automatic Shutoff Nozzle



Meters & Gauges

CODE	CONTENTS
CLG-D	Diesel Clock Level Gauge
DMDT	Digital Turbine Meter
DMDT-UTE	Diesel Digital Turbine Meter Kit - Suits all Ute Packs
DMM4	4 Digit Mechanical Meter
DPM	Diesel Pulse Meter
DFG100	Diesel Fuel Gauge - Suits DMP100E
DFG200	Diesel Fuel Gauge - Suits DMP200E
DFG400	Diesel Fuel Gauge - Suits DMP400E
DFG600	Diesel Fuel Gauge - Suits DMP600E + DMPQ400E
DFG800	Diesel Fuel Gauge - Suits DMP800E



Diesel Accessories

Filters

CODE	CONTENTS
DCF25	Water Captor Filter Cartridge Full Head Assembly - 150LPM (Metal Case)
DCF25F	Water Captor Filter Cartridge (1) -150 LPM (Metal)
DCF25CL	Clear Captor Filter Full Assembly - 2 x Cartridges 100LPM
DCF25CLF	Clear Captor Filter Cartridge Only (1) - 100LPM



DCF25

Diesel Cube Ute Pack Accessories

CODE	CONTENTS
BM35TNB-RES	35L AdBlue Reservoir Tank for Cube
DM400QBUND	Diesel 400Ltr Cube Outer Bund
STRUT430MM-200N	Gas Strut 430MM L 200N- Suits Cube Range
FCV	Diesel Vented Filling Cap - Plastic - Suits DMP Range
DMFC	Diesel Filling Cap - Metal

Diesel Accessories

CODE	DESCRIPTION
ATN65	65LPM Diesel Auto Nozzle
ATN90	90LPM Diesel Auto Nozzle
BMCB-D	Diesel MC Box
BSFMS	Piusi MC Box B.Smart
D-CONNECT2KIT	Diesel Connection Hose to Kits
DHR10M25	10m Diesel Retractable Hose Reel
DH2025-4M	4m Diesel hose - 20 x 25 Male connectors
DH2025-6M	6m Diesel hose - 20 x 25 Male connectors
DH2020-4M	4m Diesel hose - 20 x 20 Male connectors
DH2020-6M	6m Diesel hose - 20 x 20 Male connectors
DMLI	Diesel Level Indicator (OCIO)
MCBKEYS-RED	MC Box User Keys - Red Manager
MCBKEYS	MC Box User Keys (Pk 10)
MCBPCIF	MC Box PC Software & USB Convert
MCBSW	MC Box Software
SPK	Solar Panel Kit



CLG-D



BMCB-D



ATN90



DHR10M25

AdBlue® Storage

AdBlue® Portable Ute Packs



CODE	DESCRIPTION	CAPACITY (Litres)	DIMENSIONS (L x W x H)	PUMP	PUMP FLOW (LPM)	HOSE LENGTH (m)	MOUNTING FRAMES
BM100-B	Tank + 12 Volt Pump	100	770 x 540 x 500	B12V-COMET	17	4	DM100MF
BM200B-P12	Tank + 12 Volt Pump	200	1000 x 750 x 605	B12VP-P	35	4	DM200MF
BM400B-P12	Tank + 12 Volt Pump	400	1620 x 750 x 665	B12VP-P	35	4	DM400MF

AdBlue® Single Skin Slimline Tanks

CODE	COLOUR	CAPACITY (Litres)	DIMENSIONS (L x W x H)
BMSL2000RPB	Rapid Blue	2,000	2590 x 750 x 2110
BMSL3000RPB	Rapid Blue	3,000	2870 x 940 x 2150
BMSL5000RPB	Rapid Blue	5,000	3590 x 1170 x 2110



AdBlue® Accessories

CODE	DESCRIPTION
B12KP-P	IBC Kit - 12V
BATN-P	AdBlue® Auto Shutoff Nozzle (Puisi)
BDM-P	AdBlue® Pluse Meter
BDRHP-P	AdBlue® Rotary Hand Pump
BMCB-A	AdBlue® McBox
BMHR8-P	AdBlue® Hose Reel Retractable 20mm x 8m
BMLI	Level Indicator (Ocio) AdBlue®
BMTN-P	Nozzle Manual AdBlue® - Plastic (Puisi)



AdBlue® Single Skin Slimline Tank cabinet

CODE	DESCRIPTION	CAPACITY (Litres)	DIMENSIONS (L x W x H)	PUMP	PUMP FLOW (LPM)	HOSE LENGTH (m)
BMSL5000LGY-C	Slimline AdBlue® Tank - Cabinet	5,000	4140 x 1170 x 2110	B240VP-P	35	5

KEY FEATURES

- Optimised Fleet Solutions for AdBlue® storage and dispensing to SCR/DEF equipped vehicles.
- Simplifies dispensing operation
- Plug 'n' play set up for fast installation



Water Cartage



Water Cartage Tanks - Ute Pack

CODE	CAPACITY (Litres)	DIMENSIONS (L x W x H)	OUTLET
FTR200	200	1050 x 750 x 600	25mm
FTR400	400	1680 x 750 x 600	25mm
FTR600U	600	1720 x 890 x 755	25mm
FTR800U	800	1720 x 890 x 925	25mm



KEY FEATURES

- Moulded internal baffles for vehicle stability
- Brass outlet
- Tough and durable one-piece moulding
- 140mm 1/4 turn hinged lid
- High strength, lightweight polyethylene construction
- Provision for strap or pin mounting
- Wear pads to allow airflow underneath and protect ute tray



Water Cartage Tanks

CODE	CAPACITY (Litres)	DIMENSIONS (L x W x H)	OUTLET
FTR600	600	1150 x 1130 x 740	40mm
FTR800	800	1400 x 1200 x 740	40mm
FTR1200	1200	1450 x 1200 x 1000	40mm
FTR2000	2000	1900 x 1450 x 1100	40mm
FTR3000	3000	2100 x 1500 x 1200	40mm



KEY FEATURES

- Moulded internal baffles for vehicle stability
- Brass outlet
- Forklift galvanised skids available
- Tough and durable one-piece moulding
- 400mm 1/4 turn hinged lid
- Sits directly on any flat surface
- High strength, lightweight polyethylene construction
- Provision for strap or pin mounting



Compact Fire Fighting Packages



CODE	CAPACITY (Litre)	DIMENSIONS (TANK) (L x W x H)	PUMP CODE	ENGINE/PUMP	STARTER	HP
FTRC200-25	200	1050 X 750 X 600	MB25L	Loncin/Onga	Pull Petrol	2.5
FTRC200-55	200	1050 X 750 X 600	B55H	Honda/Onga	Pull Petrol	5.5
FTRC400-25	400	1680 X 750 X 600	MB25L	Loncin/Onga	Pull Petrol	2.5
FTRC400-55	400	1680 X 750 X 600	B55H	Honda/Onga	Pull Petrol	5.5
FTRC400-55-HR*	400	1680 X 750 X 600	B55H	Honda/Onga	Pull Petrol	5.5
FTRC600-55	600	1720 X 890 X 755	B55H	Honda/Onga	Pull Petrol	5.5
FTRC600-55-HR*	600	1720 X 890 X 755	B55H	Honda/Onga	Pull Petrol	5.5
FTRC800-55	800	1720 X 890 X 925	B55H	Honda/Onga	Pull Petrol	5.5
FTRC800-55-HR*	800	1720 x 890 x 925	B55H	Honda/Onga	Pull Petrol	5.5

*HR - Includes 36m Hose Reel

KEY FEATURES

- Tough and durable one-piece moulding
- Sits directly on any flat surface
- High strength, lightweight polyethylene construction
- 12m hose with fire fighting nozzle
- Wear pads to allow airflow underneath and protect ute tray
- 36m Hose Reel & Fire-Fighting Nozzle with all - HR models

*Refer to Water Cartage & Fire Fighting Pumps page 61 for full pump details



FTRC800-55-HR



FTRC600-55

Skid Mounted Fire Fighting Packages



CODE	CAPACITY (Litres)	STARTER	DIMENSIONS (L x W x H)	ENGINE*
FTRS600	600	Pull-Petrol	1800 x 1400 x 850	B65HT
FTRS600ES	600	Electric- Starter	1800 x 1400 x 850	B65HTES
FTRS800	800	Pull-Petrol	1900 x 1400 x 850	B65HT
FTRS800ES	800	Electric- Starter	1900 x 1400 x 850	B65HTES
FTRS1200	1200	Pull-Petrol	1900 x 1400 x 1100	B65HT
FTRS1200ES	1200	Electric- Starter	1900 x 1400 x 1100	B65HTES
FTRS2000	2000	Pull-Petrol	2100 x 1800 x 1200	B65HT
FTRS2000ES	2000	Electric- Starter	2100 x 1800 x 1200	B65HTES

KEY FEATURES

- 6.5HP Honda twin-impeller pump
 - 36m hose reel and fire fighting nozzle included
 - Heavy duty galvanised skid frame
 - Fork on - fork off capability
 - Bottom fill manifold with 6m suction hose
 - Optional dust suppression nozzle kit available (DSN20K)
- *Refer to Water Cartage & Fire Fighting Pump page 61 for full pump details

Skids Only

CODE	COMPATIBILITY	DIMENSIONS L x W x H
FFS600	600Ltr FTR Tanks	1595 x 1120 x 115
FFS800-1200	800 - 1200Ltr FTR Tanks	1745 x 1350 x 115
FFS2000	2000Ltr FTR Tanks	1940 x 1690 x 115



FTRS2000

Trailer Packages

Fire Fighting Trailers



CODE	CAPACITY (Litres)	PUMP*	STARTER	ENGINE/PUMP	TANK DIMENSIONS (L x W x H)	TRAILER DIMENSIONS (L x W x H)
FTRT1200T	1200	B65HT	Pull - Petrol	Honda/Onga	1450 x 1200 x 1000	3940 x 1770 x 1500
FTRT1200TES	1200	B65HTES	Electric - Petrol	Honda/Onga	1450 x 1200 x 1000	3940 x 1770 x 1500
FTRT1200TESD	1200	FFDPTES	Electric - Diesel	Yanmar/Onga	1450 x 1200 x 1000	3940 x 1770 x 1500
FTRT2000	2000	B65HT	Pull - Petrol	Honda/Onga	1900 x 1450 x 1200	4460 x 1970 x 1650
FTRT2000ES	2000	B65HTES	Electric - Petrol	Honda/Onga	1900 x 1450 x 1200	4460 x 1970 x 1650
FTRT2000ESD	2000	FFDPTES	Electric - Diesel	Yanmar/Onga	1900 x 1450 x 1200	4460 x 1970 x 1650

KEY FEATURES - TRAILER

- Hot dip galvanised dual axle trailer
- 14" wheels - 5 stud pattern
- Electric brakes - 2000ltr
- Hydraulic brakes - 1200ltr
- Road pack including brakes and LED lights
- Emergency breakaway protection
- Compliance plate - road registrable

KEY FEATURES - TANK AND PUMP

- 6.5HP Honda powered twin impeller pump
- 400mm 1/4 turn hinged lid
- Trailer mounted toolbox to protect the hose
- Suction return manifold with 6m suction hose
- 36m Hose reel & fire fighting nozzle
- Optional dust suppression nozzle kit available (DSN20K)
- *Refer to Water Cartage & Fire Fighting Pumps page for full pump details

FTRT1200TES



Water Cartage & Fire Fighting Pumps

CODE	DESCRIPTION	ENGINE/ PUMP	STARTER	POWER (HP)	HEAD (m)	FLOW (LPM)	INLET	OUTLET	# OF OUTLETS	WARRANTY (yrs)
MB25L	Mini Blaze 2.5HP	Loncin/Onga	Pull - Petrol	2.5	21	133	25mm BSPM	25mm BSPM	1	1
B55H	Honda 5.5HP Single Impeller	Honda/Onga	Pull - Petrol	5.5	60	585	32mm BSPM	25mm, 25mm, 40mm BSPM	3	2
B65HT	Honda 6.5HP Twin Impeller	Honda/Onga	Pull - Petrol	6.5	100	373	50mm BSPM	25mm, 25mm, 40mm BSPM	3	2
B65HTES	Honda 6.5HP Twin Impeller Electric Start	Honda/Onga	Electric - Petrol	6.5	100	373	50mm BSPM	25mm, 25mm, 40mm BSPM	3	2
FFDPTES	Yanmar 7HP Diesel Electric Start	Yanmar/Onga	Electric - Diesel	7	100	450	50mm BSPM	25mm, 25mm, 40mm BSPM	3	2

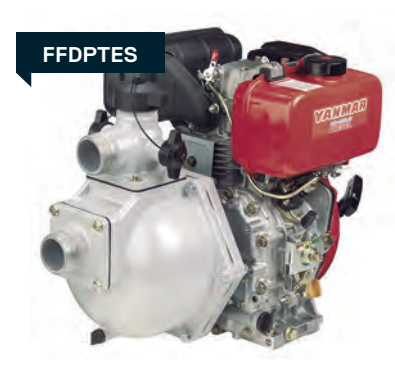

Fire Fighting Accessories

CODE	DESCRIPTION	DIMENSIONS (L x W x H)
BFK	Bottom Fill Kit - Suits FTRC 5.5HP Compact Fire Units	
FFHR1	Hose Reel 20mm x 36mtr	555 DIA x 165W
TFFK	Tank Fire Fighting Kit with 36mtr Hose reel on galvanised stand	900 x 600 x 700
FHR	Manual Hose Reel 20mm x 36mtr	427 x 391 x 380
DSN20K	Dust Suppression Nozzle	



* Includes hose

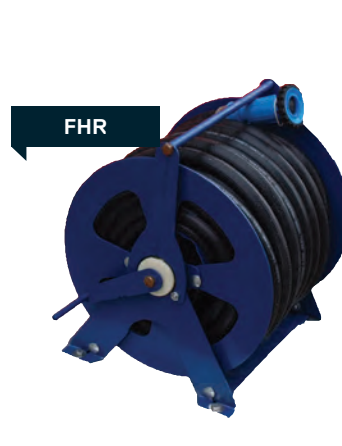

* Includes hose

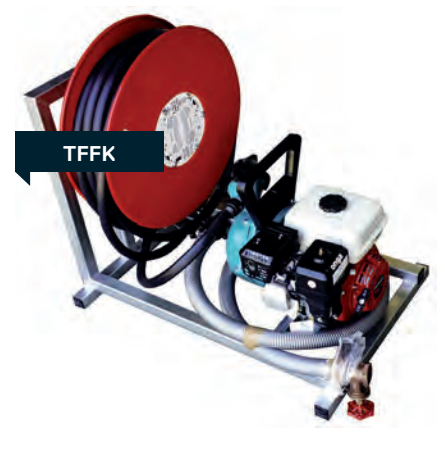

Safety & Spill Containment

CODE	DESCRIPTION	DIMENSIONS (L x W x H)
IBCB1100	IBC Bund 1100L	1680 x 1680 x 700
LSS1	Lead safe stand	500 x 500 x 2100
FHRC36	Fire Hose Reel Cover - suits 36m hose	600 x 205 x 580
FHRC50	Fire Hose Reel Cover - suits 50m hose	575 x 270 x 600
PTC6	Drum top cover to suit 205ltr	600 x 600 x 300
BCL	Bollard Cover - Large	Ø200 x 1780H
BCS	Bollard Cover - Small	Ø120 x 1780H
BT1	Butt Tidy	Ø410 x 1000H
DSBAR	Bund-a-rack	1280 x 1280 x 280
DSDB2	Drumsafe two drum bund	1550 x 75 x 450
DSDP	Drumsafe Drumpak	Ø780 x 1080H
DSEP4	Drumsafe Econopallet 4 Drum	1210 x 1210 x 300
DSP	Drumsafe Bundled Pallet	1280 x 1280 x 335
DSST1	Splash Tray 1 Drum	830 x 830 x 100
DSST2	Splash Tray 2 Drum	1560 x 810 x 145
DSST4	Splash Tray 4 Drum	1210 x 1210 x 100

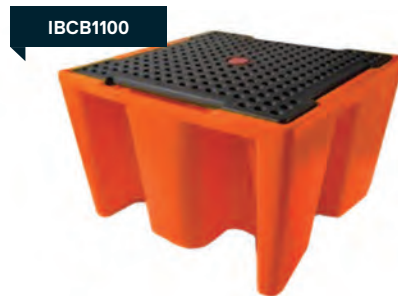

Order Form



T 03 5033 9000 E sales@polymaster.com.au W polymaster.com.au

Date: _____ Site Contact name: _____
 Distributor: _____ Delivery Address (if not to store): _____
 Distributor ID number: _____

 Phone: _____
 Contact name: _____ Email: _____
 Phone: _____ Order no. (required) _____

NO	PRODUCT CODE	DESCRIPTION	COLOUR	QTY	UNIT PRICE (EX.GST)
1					
2					
3					
4					
5					
				FREIGHT	
				TOTAL	

ADDITIONAL OPTIONS	SIZE REQUIRED	QTY	UNIT PRICE	AMOUNT
UPGRADE OUTLET? YES <input type="checkbox"/> NO <input type="checkbox"/>				
ADDITIONAL OUTLET? YES <input type="checkbox"/> NO <input type="checkbox"/>				
MANHOLE COVER INSTEAD OF STRAINER? <input type="checkbox"/>	MANHOLE COVER IN ADDITION TO STRAINER? <input type="checkbox"/>			
ACCESSORIES REQUIRED? YES <input type="checkbox"/> NO <input type="checkbox"/>				

FILL IN ADDITIONAL DETAILS BELOW FOR TANK ORDERS ONLY - SELECT FITTING POSITIONS

Outlet:
Overflow:

Outlet:
Overflow:

Outlet:
Overflow:

* Minimum order \$300
 * Tank specs available at polymaster.com.au

Email to sales@polymaster.com.au to place your order

Disclaimer: Colours and sizes may vary from details printed

Delivery & Installation

It is the owner's responsibility to provide clear access to site, and to secure tank/s left at site.

If the driver cannot reach the location, the tank/s will be left at the closest practical & safe position at the driver's discretion. If a tank can not be left at site, the owner will incur a redelivery charge.

All products can be delivered throughout Australia. Call us for a quote for deliveries outside nominated zones.

Nominated Zones Free Delivery

Polymaster offers free delivery to site throughout most of Victoria, South Australia and parts of Southern New South Wales for tanks exceeding 13,000ltrs (remote areas excluded). Please refer to our free delivery zone map on polymaster.com.au/delivery-installation.

All tanks less than 13,000ltrs are delivered free to store (within the nominated zone). A delivery fee will be incurred to deliver these tanks to site.

Delivery Requirements

Clearance required for truck and trailer is 19m long, 5m high, 3.5m wide. To put this into perspective, our trucks are longer than a semi-trailer.

The good news is that no-one is required to help the driver unload. Please provide a free and easy access to your site and an identified 'marked' area for the tank to be unloaded. Our driver will unload as close as possible your desired location.

If the driver deems the desired location to be too difficult to manoeuvre the truck into, the driver will identify a safe and secure place to unload within your property.

Please note: The driver is unable to physically position the tank onto the 'pad'. Exact positioning of the tank on the pad remains the responsibility of the property owner.

Note:

- It is the Owners responsibility to position the tank on the pad and to connect the tank.
- Please refer to lifting instructions (Polymaster.com.au/delivery-installation) for tanks greater than 25,000ltrs as lifting equipment will be required to position on the pad by the Owner.

Underground and Septic Tanks will require a lifting device (forklift etc) to unload from the truck. This is not supplied by the driver.

Re-Scheduling Fee

Please be advised that if the Owner chooses to change the delivery date a re-scheduling fee will be incurred.

Installation Guide

Entry to tank is not required when installing a Polymaster tank!

The tank site must be firm, level and flat.

A concrete pad (min dia. of tank), or well compacted sand base or other consolidated fill such as crushed dust is recommended. This fill must be free of any rocks, stones or any sharp objects.

The sand base or other consolidated fill base must be 75mm – 100mm deep and at least 600mm larger in diameter than the tank base. The outside of the base must be supported by a retaining wall to prevent erosion.

The overflow must be piped well clear of the tank to avoid any undermining of the tank base.

Ensure that a flexible hose of at least 300 mm (12") is installed after the tank valve to absorb any shocks or movement.

If tank is placed on a stand, support pipework off the stand, never support pipework off the tank.



Note: Failure to properly install tank as per instructions will void warranty. Never enter a tank alone. Have an attendant stand by. Restricted Space - only enter after carrying out a Hazard Identification Risk Assessment (H.I.R.A.).

Index A - F

PRODUCT CODE	PAGE	PRODUCT CODE	PAGE	PRODUCT CODE	PAGE	PRODUCT CODE	PAGE
A		BV1.5A	9	DMP600E	44	FSB200	37
A60	50	BV2A	9	DMP800E	44	FT200	19
A80	50	C		DMP1200	45	FT500B	19
AFV0L	31	CFA1	21	DMP2000	45	FT1000B	19
AFV2	31	CFA2	21	DMP3000	45	FT2000B	19
AFV2L	21	CFAC	21	DMPD1200	45	FT2000B+V	19
AFV2LB	16/21	CFANT	21	DMPD2000	45	FT5000B	19
AFV2SEAL	31	CFS1	21	DMPD3000	45	FT5000B+V	19
AFV3B	31	CFS2	21	DMPF1200	45	FT9000B	19
AFV4B	31	CFT8	29	DMPF2000	45	FT9000B+V	19
AFV5B	31	CFT8E	29	DMPF3000	45	FTL2000	19
AFV6	31	CLG	20/51/52	DMPFT1200	46	FTP9	29
AFV6L	31	CUBE56-12V	50	DMPFT2000	46	FTR200	54
APRS	19	CUBE70-240V	50	DMPQ400E	44	FTR400	54
ATN65	52	D		DP2	27/28/31	FTR600	54
ATN90	52	DC2	31/35/36	DP4B	31	FTR600U	54
B		DC3	24/25/26/31	DP50K	51	FTR800	54
B12KP-P	53	DC3SE	31	DP50PUMP	44	FTR800U	54
B12V-COMET	53	DCF25	52	DP50PUMP12V-ASY	45/51	FTR1200	54
B12VP-P	53	DCF25CL	52	DP72K	51	FTR2000	54
B55H	55/58	DCF25CLF	52	DP72KA	51	FTR3000	54
B65HT	55/56/57/58	DCF25CLF	52	DP72PUMP	51	FTRC200-25	55
B65HTES	56/57/58	DCF25F	52	DP80K	51	FTRC200-55	55
B240VP-P	53	D-CONNECT2KIT	52	DP85K	51	FTRC400-25	55
BATN-P	53	DCSE	31/36	DP85PUMP	46/51	FTRC400-55	55
BB12	40	DFG100	51	DP85PUMP12V	45	FTRC400-55-HR	55
BB12XL	40	DFG200	51	DP1224K	51	FTRC600-55	55
BB16	40	DFG400	51	DP1224PUMP	51	FTRC600-55-HR	55
BB16XL	40	DFG600	51	DP1224PUMP12V	45	FTRC800-55	55
BBLID	40	DFG800	51	DP3570K	51	FTRC800-55-HR	55
BC	33/36	DH2020-4M	52	DPK1	20	FTRS600	56
BCL	59	DH2020-6M	52	DPK1EXT	20	FTRS600ES	56
BCS	59	DH2025-4M	52	DPM	51	FTRS800	56
BDM-P	53	DH2025-6M	52	DPSE	31	FTRS800ES	56
BDRHP-P	53	DHJ600	13/23	DSBAR	59	FTRS1200	56
BFK	58	DHJ800	23	DSDB2	59	FTRS1200ES	56
BM35TNB-RES	52	DHR10M25	52	DSDP	59	FTRS2000	56
BM100-B	53	DM100MF	53	DSEP4	59	FTRS2000ES	56
BM200B-P12	53	DM200MF	53	DSN20K	56/57/58	FTRT1200T	57
BM400B-P12	53	DM400MF	53	DSP	59	FTRT1200TES	57
BMCB-A	53	DM400QBUND	52	DSST1	59	FTRT1200TESD	57
BMCB-D	52	DM1200	45	DSST2	59	FTRT2000	57
BMHR8-P	53	DM2000	45	DSST4	59	FTRT2000ES	57
BMLI	53	DM3000	45	DSW5000LGY	47	FTRT2000ESD	57
BMSL2000RPB	53	DMDS2300	49	DSW7000LGY	47	G	
BMSL3000RPB	53	DMDS3300	49	DSW10000LGY	47	GAB2	38
BMSL5000LGY-C	53	DMDS5000	49	F		GBL	39
BMSL5000RPB	53	DMDS7000	49	FCV	52	GBLLIDN	39
BMTN-P	53	DMDS10000	49	FFDPTES	57/58	GS40	38
BSFMS	52	DMDT	51	FFHR1	58	H	
BSLT2020H4	11	DMDT-UTE	51	FFS600	56	HHR-370PC	22
BSLT2020H5	11	DMFC	52	FFS800-1200	56	HHR-370S-PC	12/22
BSLT2020PC	11	DMLI	52	FFS2000	56	HL4	36
BT1	59	DMM4	51	FHR	58	HSJ1000	23
BUC14	43	DMP100E	44	FHRC36	59	HSP	37
BUC26	43	DMP200E	44	FHRC50	59	HT28	43
		DMP400E	44	FLBF	33		
				FRB	30		

Index F - P

PRODUCT CODE	PAGE
HT28P	43
HTP750VR	19
I	
IBCB1100	59
IRS32	21
IRS40	21
J	
JOS90	20
JWK	36
K	
K33	50
L	
LFT50KL	18
LFT9000	18
LFT13600	18
LFT22500	18
LFT31700	18
LFTK	18
LGSO	20
LHO3SS	18/21
LHO1.5SS	21
LHO1.25SS	21
LHO1SS	21
LHO2SS	18/21
LQ01	18/20
LSS1	59
LT	33/36
LT01	20
LWD	20
M	
MB25L	55/58
MB60L	40
MB60P	40
MB100L	40
MB100P	40
MB150L	40
MB150P	40
MB200L	40
MB200P	40
MBL	33
MBP	32
MCBKEYS	52
MCBKEYS-RED	52
MCBPCIF	52
MCBSW	52
MG2W	36
MG4M	34/36
MG4W	36
MG5M	34/36
MG6M	34/36
MG40P	34
MG50LTAP	34

PRODUCT CODE	PAGE
MG50P	34
MG50TAP	34
MG60P	34
MG400T	34
MG800T	34
MGD1	36
MGD2	36
MHC1	20
MHC3	9/20
MHC4	9/20
MHC5	9/20
MHC6	9/10/20
MHC7	10
MHC8	11/12/13/20
MHC9	12/20
MHCA	9/10/20
MHR20-370	11/22
MHR20-550	11/22
MM1L	33
MM1P	32
MM5BR	32/33/36
MM5L	33
MM5P	32
MM8L	33
MM8P	32
MM12BR	32/33/36
MM12L	33
MM12P	32
MM13L	33
MM13P	32
MMT400	34
MOL50KL	17
MOL13600	17
MOL22500	17
MOL31700	17
MT2	24/31
MT04	24
MT05	24
MT6	24/31
MT12	24/31
MT24	24
MT45	24/31
MTFC	24/31
MTP110	36
O	
OFF9	20
OFF10	20
OFFP	20
OS9	20
P	
PBL85	39
PBL100	39
PBL145	39
PBLD	39
PC01	13/20
PCR2000	10

PRODUCT CODE	PAGE
PCR4000	10
PCR5000	10
PCR7000	10
PCR10000	10
PCR13500	10
PCR22500	10
PCR27000	10
PCST600	12/13
PCST1050	12/13
PCST1050AP	12
PCST1050GPS	13
PCST2000	12
PCST2000AP	12
PCST2000GPS	13
PCST3000	12/13/15
PCST3000AP	12
PCST3000GPS	13
PCST5000	12
PCST5000AP	12
PCST5000GPS	13
PCT	32/36
PCTL12	28
PCTL24	28
PCTR22	28
PCTR66	28
PCTR120	28
PH400	23
PH550	23
PHGPS	23
PLT50KL	16
PLT9000	16
PLT13600	16
PLT22500	16
PLT31700	16
PLTIP25	21
PLTIP40	21
POB20	37
PPB100	39
PPB100FC	39
PPBL	39
PSC	37
PT02	35/36
PT02FS	35/36
PT02STBR	35/36
PT03	35/36
PT03R	35/36
PT04WC	35/36
PT05	29
PT05C	29
PT05R	29
PT10W	24
PT11W	24
PT12W	24
PT13W	24
PT14	35/36
PT14BR	35/36
PT15	35/36
PT48W	35/36
PT48WB	35/36

PRODUCT CODE	PAGE
PT49BR	35/36
PT49BRS	35
PT49W	31/35/36
PT49WB	35/36
PT50W	31/35/36
PT50WB	35/36
PT90BRS	35
PT90W	35
PT2132	21
PT2140	21
PT2150	21
PTB25	33
PTB32	33
PTBL25	33
PTBL32	33
PTC6	59
PTC36F	29
PTC36I	29
PTC37F	29
PTC37I	29
PTF18	35
PTM31F	29
PTM31W	26/31
PTM32F	29
PTM32W	26/31
PTM33F	29
PTM33W	26/31
PTM34F	29
PTM34W	26/31
PTMFC	26/31
PTWK7	36
R	
R10112	20
RFRB	30
RFS	21
RFS2	21
RMT	34/36
RWT50KL	8/9
RWT200	8/9
RWT600	8/9
RWT1000	8/9
RWT1600	8/9
RWT2270LP	8/9
RWT2270T	8/9
RWT3300	8/9
RWT4500LP	8/9
RWT4500T	8/9
RWT5000	8/9
RWT7100	8/9
RWT9000	8/9
RWT13600	8/9
RWT22500	8/9
RWT31700	8/9
S	
S2	9/21
S3	9/10/12/21

Index P - W

PRODUCT CODE	PAGE
S4	9/10/11/12/13/21
S5	9/10/21
SC80-F	18/21
SCIT	32/36
SCITP	36
SCL	36
SCP	36
SKD1200	45
SKD2000	45
SKD3000	45
SL5	36
SM5000D	41
SM5000HDD	41
SM5000HDL	41
SM5000L	41
SM7500D	41
SM7500HDD	41
SM7500HDL	41
SM7500L	41
SM10000D	41
SM10000HDD	41
SM10000HDL	41
SM10000L	41
SM20000L	42
SM25000L	42
SM30000L	42
SMDf5000	41
SMDf7500	41
SMDf10000	41
SPK	52
SPT5	26/31
SPT9	26/31
SPT12	26/31
SPTA	26/31
SPTAL	26/31
SSBV1	21
SSBV2	21
SSBV3	18/21
ST3100	15
ST4550	15
STB250	27
STB450	27
STBOXBASIC	50
STBOXMETER12V	50
STBOXPRO	50
STLIDHGR	15
STMETER12V	50
STMETER240V	50
STRUT430MM-200N	52
SWP250	27/31
SWP250-40	27/31
SWP250FC	27/31
SWP450	27/31
SWP450-40	27/31
SWP450-50	27/31
SWP450FC	27/31
SWT15	25/31
SWT4500	25/31
SWTC	25/31

PRODUCT CODE	PAGE
T	
TBC20	43
TBC20FH	43
TDD1	38
TDD3	38
TFFK	58
TIF3	21
TIF4	21
TS600	20

PRODUCT CODE	PAGE
U	
URRM	14/15/20
URRM-SMALL	15/20
URT3300B	14
URT3300VF	14
URT3300VF/GP	14
URT3300VF/PC	14
URT5000B	14
URT5000VF	14
URT5000VF/GP	14
URT5000VF/PC	14
URTL	14/20
URTL-SMALL	15/20
URVF01	21
URVF15	21
URVF30	21
URVFR	21
URVFWM	21

PRODUCT CODE	PAGE
W	
WCK01	19
WCK02	19
WfV1	21
WfV2	21
WfV3	21



CREATE YOUR PERFECT MATCH

BUILD YOUR OWN TANK

Customise your water tank to suit your style and needs with our easy to use 3D Tank Builder.

Rotate your tank to see it from any angle, position your fittings, change the colours, and add on accessories.

See your selections change in real time.



Imagine taking control and building your own personal water tank!

Well... we're putting you in the driver's seat, so you control the build of your next tank. We have made it easy for you with our innovative and intuitive 3D modelling software. You can now quickly get 'up close & personal' with your tank online. Through our specialised software, you can now see your tank, look at it from every angle,

change its colours, position all your fittings and even add-on critical accessories that will keep your water fresh and clean.

And, when you've created your masterpiece you can download the exact specifications of your tank including a colour image of it and its cost. How cool is that? It's so easy!



It's online, and it's FREE at polymaster.com.au

This page has been left blank intentionally

This page has been left blank intentionally



Together we hold the future.

P: 1800 062 064

W: polymaster.com.au

Swan Hill | Melbourne | Adelaide | Sydney | Brisbane