

# **AG+ Pro Silver Ion Antiviral Air Purifier**

(NSP-PCO)

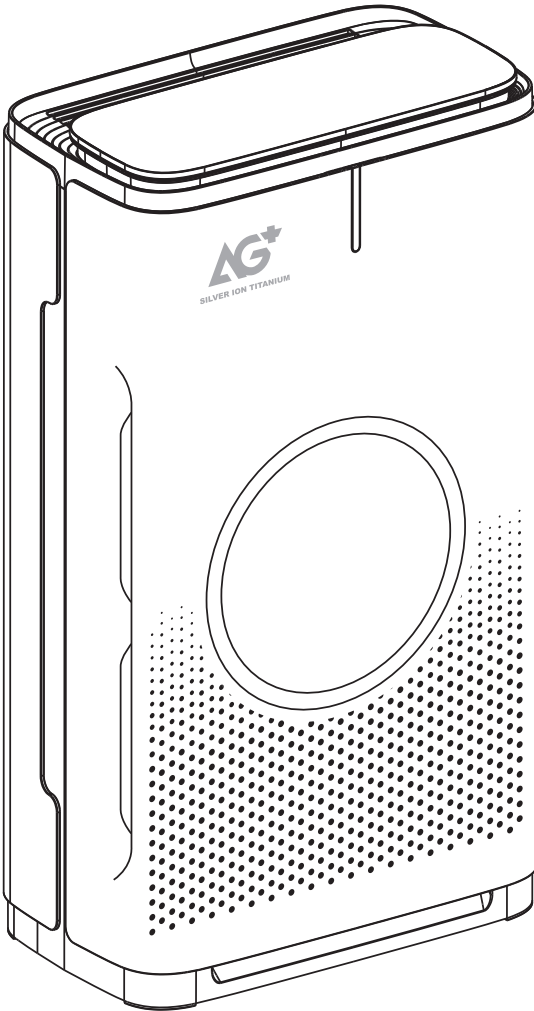

## **User Manual**

1. Please read this instruction manual carefully and keep it safely
2. Please remove all the packaging material from the filters

# CONTENTS

Air Purifier and Accessories	02
Disinfection Principle and Product Structure	03
QuickStart Guide	04
Precautions	05
Operating Instructions	06
Technical Specifications	07
Cleaning and Maintenance	08
Troubleshooting	08
After Sales Service	09
After Sales Warranty	09

# AIR PURIFIER AND ACCESSORIES

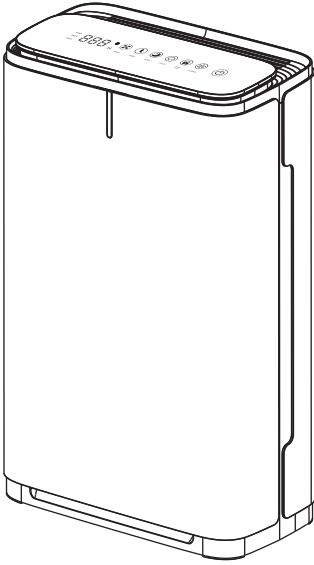

Air Purifier Unit

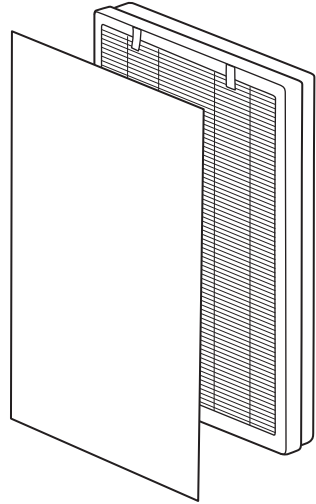

High efficiency filter

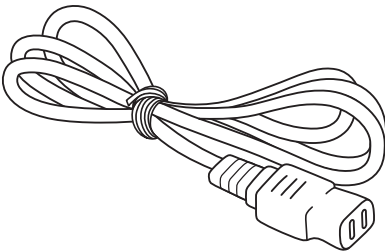

Power Cable with Plug

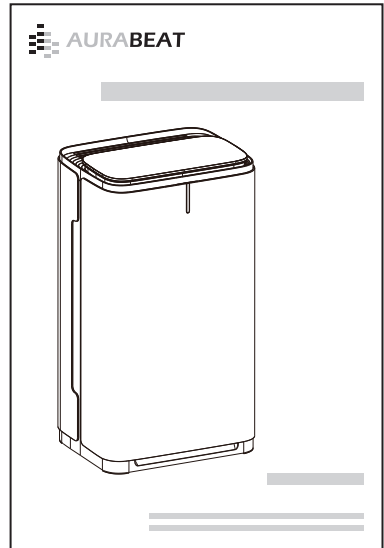

User Manual

# DISINFECTION PRINCIPLE AND PRODUCT STRUCTURE

## Disinfection Principle

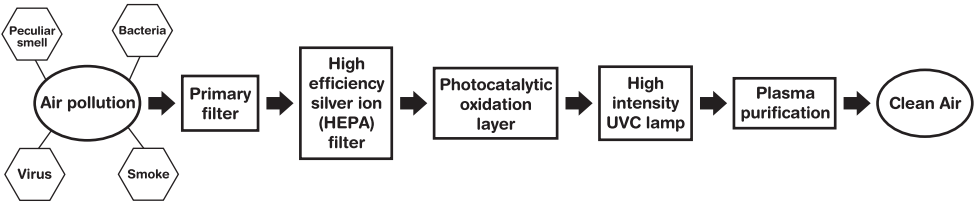

This product circulates air to drive the virus and microorganism in air into the sterilizer, through a series of air disinfection and purification mechanisms, pre-filter and high efficiency silver ion filtration layer, high power UVC ultraviolet light, photocatalytic oxidation, and plasma purification to enable high efficiency air disinfection and purification. Since the ultraviolet lamp is sealed in the disinfection chamber, the air can be disinfected when it passes through the disinfection chamber, so the product has no ultraviolet light leakage. This product is composed of pre-filter, high efficiency silver ion filter, Photocatalytic oxidation layer, high intensity UV sterilization layer, plasma purification, as well as the combination of motor, wind wheel, control module and air duct accessory.

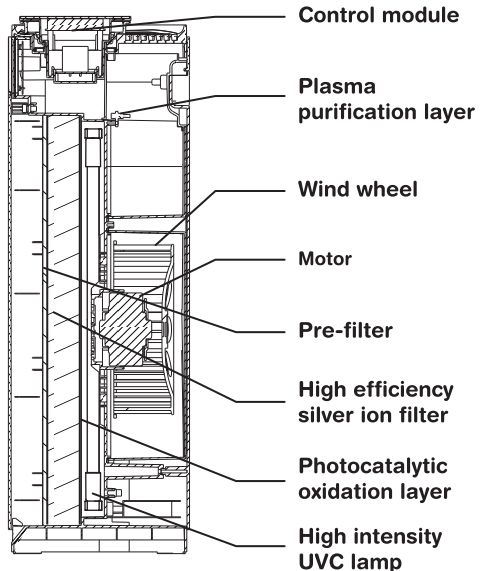
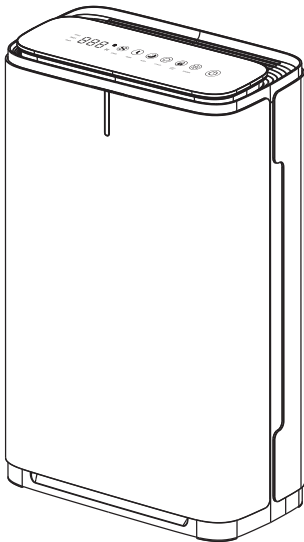

# QUICKSTART GUIDE

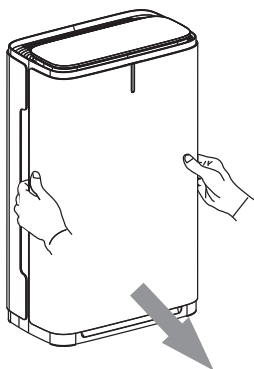

1. Remove front panel.

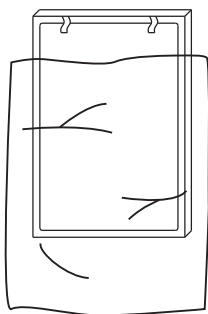

2. Remove filters.

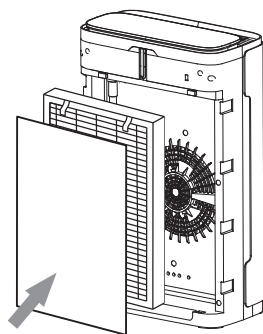

3. Install filters.

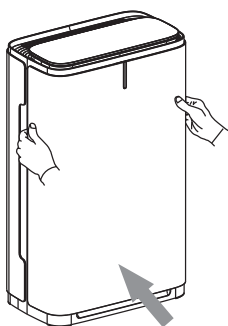

4. Install front panel.

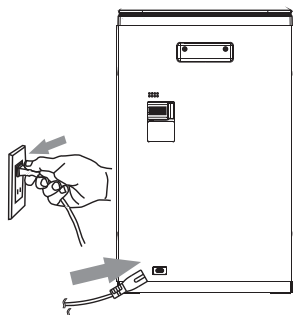

5. Connect power.

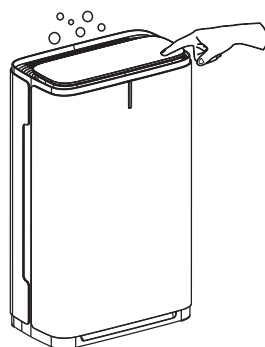

6. Press on/off button to switch on the air purifier.

# PRECAUTIONS

## — WARNING —



Disassembly is prohibited. To avoid danger, do not disassemble and modify the product if you are not a professional mechanic.



Check the power cable and plug regularly. Dust can be accumulated over time on the surface of the plug, which can cause poor insulation due to humidity. Unplug it regularly and clean the plug with a dry cloth. Unplug it from the electrical outlet when not used for a long time.



Do not use on improper AC. Damage or danger could be resulted from using it on improper power sources.



The electrical plug must be plugged in all the way. Otherwise, fire hazards could be resulted from overheating due to exposed plug prongs. Do not use a damaged plug or a loose electrical outlet.



Do not use the appliance in wet or highly humid surroundings such as the bathroom to prevent leakage current, electric shock and fire hazards.



Do not use the appliance when you have used spray-type insecticides. After using insecticides, ventilate the room sufficiently before using the air purifier. Otherwise, chemicals will be accumulated inside the machine and affect your health.



Do not use alcohol or organic solvents to clean any part of the appliance to prevent damage to the product, electric shock, fire hazards, etc.



Make sure there is at least 5cm space at the back of the air purifier so as not to bend the electronic plug connected to the machine to avoid damaging the cable, which may cause short circuit or overheat. Additionally, it is important to avoid placing the machine too close to the wall, as this can affect the operation of the air quality sensor. To prevent damage to the cable, avoid pressing the power cable plug connected to the machine.



To avoid electric shock or damage, keep foreign object away from the air inlet and outlet to avoid contacting the inner parts of the appliance.



Always unplug the air purifier before cleaning the unit to protect against injuries and danger.



To avoid electric shock, do not touch the electrical plug with a wet hand.



To prevent short circuit and electric shock, do not immerse in water or other liquids.



Do not use in places with oily residues, smoke, or fumes, such as the kitchen to prevent damage to the product. The appliance shall not be used as an exhaust fan.



When used in the same space with combustion devices, make sure the room is well-ventilated to prevent carbon monoxide poisoning as the appliance does not remove carbon monoxide.



Unplug the appliance by pulling the plug but not the cable to prevent damage to the cable, short circuit, electric shock, fire hazards, etc.



Close doors and windows for efficient and rapid air cleaning. Do not use the appliance near fire or combustible materials.

## NOTE

**Unplug immediately if any of the following conditions occur:**

- the switch does not work
- short circuit occur
- the electrical cable or plug becomes overheated
- a burnt smell, unusual sound or vibration is produced
- anything unusual or failures occur

Note: If the electrical cable is damaged, to prevent hazards, it must be replaced by professionals from the manufacturer, its maintenance or similar department.

# OPERATING INSTRUCTIONS



## Switch on

Touch the power button to switch on the appliance.

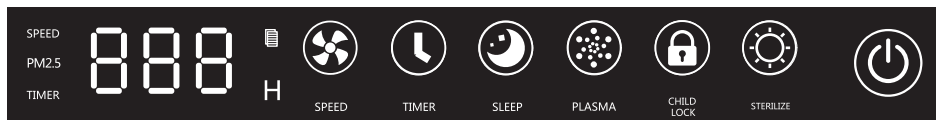

After switching on, the light indicator is always on. When a corresponding function is used, the light indicator under the icon is always turned on. The area displaying “ — — — ” 10s after switching on will show the PM2.5 value.

The appliance operates under the auto mode by default.

The airflow is adjusted according to PM2.5. Auto mode is set as follows:

PM2.5 Value	Air Quality Level	Air Quality Light Color	Airflow Level
010-079	Good	Green	1
080-199	Fair	Blue	2
200-500	Bad	Red	3



## Changing fan speed

Touch the “Fan Speed” button repeatedly to disable auto mode and manually change the speed among three settings (speeds 1-3). You can reselect auto mode by touching the button after speed 3.



## Set the timer

Touch the “Timer Button” repeatedly to choose the number of hours you want the appliance to operate (1-12 hours) and the switch-off time. When the timer is on, the light indicator is on.



## Use sleep mode

1. Touch the "Sleep" button to enter sleep mode. The air quality indicator will be dimmed. All the light indicators will be off except the sleep indicator.
2. The appliance operates under speed 1 in sleep mode. Disable sleep mode and return to previous setting by touching any button.



## Use sterilizer

Touch the "Sterilize" button to turn on/off the UV sterilizer.



## Set the child lock

Touch the "Child Lock" button to activate the lock function and all the other buttons will not be responsive. Press and hold for 3 seconds to close.



## Switch on plasma

Touch the "Plasma" button turn on/off the plasma function.



## Replace the filter

Tips on replacing the filter

When the accumulated usage time of the filter reaches 2000 hours, the filter replacement indicator is on.

Steps to replace the filter

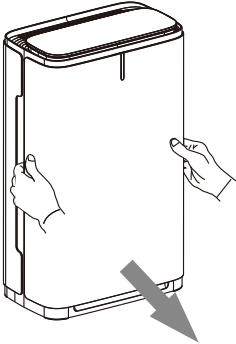

1. Open the front panel and remove the existing filters

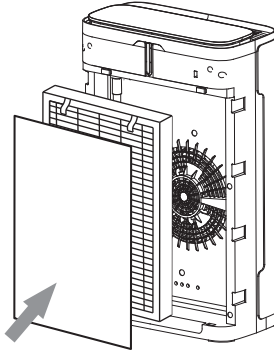

2. Install new filter

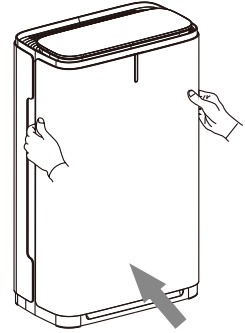

3. Insert the front panel and the filter is successfully replaced

After replacing the filter, turn off the filter indicator.

## TECHNICAL SPECIFICATIONS

Types	Specifications
Product Name	AG+ Pro Silver Ion Antiviral Air Purifier
Voltage	220-240V
Frequency	50/60Hz
Power	120W
UVC lamp power	24W
Max. Area	43m <sup>2</sup>
Casing Material	High Quality ABS
Product Dimension	390 x 211 x 628 mm
Net Weight	7.92kg
Sensor Type	PM2.5 Sensor
Max. Noise	≤58dBA



# CLEANING AND MAINTENANCE

**Unit:** Please regularly wipe the surface of the machine with a soft cloth moistened with clean water and detergent and clean the air inlet and outlet with a brush.

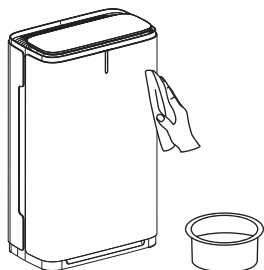

**Sensor Cleaning:** Regularly clean the lens of the sensor and the surface of the sensor with a moist cotton swab, and then use a dry cotton swab to remove any moisture left on the sensor.

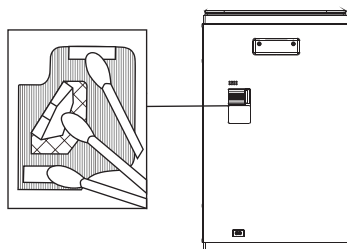

**Filter Replacement:** Filter replacement is reminded by a built-in program. Each layer of the filter can be used for about 6-8 months. If the environment is seriously polluted, the filter needs to be replaced earlier.

Filters can be ordered from our website or designated distributors.

**Filter Cleaning:** The filter needs cleaning regularly to ensure the best performance.

Pre-filter can only be cleaned with a vacuum cleaner.

The nano-crystalline filter can be cleaned by exposure to sunlight for 1 to 3 hours every 2 months.

**UV lamp:** light intensity ultraviolet radiation will affect the height of the air disinfection effect, once per month should be wiped with alcohol cotton ball UV lamp at least. To ensure that the ultraviolet lamp is not affected by dust and the radiation intensity.

**Clean the UV lamp**

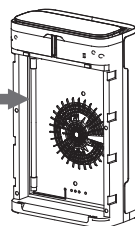

# TROUBLESHOOTING

When the following problems occur, try possible solutions listed below before returning it for repair:

Problem	Solution
The appliance does not work when switched on. The touchscreen controller does not work.	<ol style="list-style-type: none"> <li>1. Check if the electrical cable is plugged into a socket.</li> <li>2. Check if the electrical cable is plugged into the appliance.</li> <li>3. Check if the front panel is inserted properly.</li> </ol>
When in auto mode, the air quality indicator / PM2.5 value is always red or high.	<ol style="list-style-type: none"> <li>1. The appliance may be affected by moisture, oil residues, smoke, fumes, spray, etc. Place the appliance in another environment to test again.</li> <li>2. Take off the lid on the sensor and clean the lens with a soft cloth.</li> </ol>
Unpleasant smell cannot be removed.	<ol style="list-style-type: none"> <li>1. Check if the filter is expired or has adsorbed pollutants with bad smell.</li> <li>2. The nano-crystalline filter can be reused after exposure to sunlight. If the problem persists, change the filter.</li> </ol>
Particulates in the air cannot be removed. The appliance is extra loud when running.	Use a vacuum cleaner to clean the pre-filter. If the problem persists, change the filter.
The air purifier does not respond to air pollutants in the room.	The appliance may be placed in the wrong place that prevents pollutants from being absorbed. Place it in another spot or change to manual mode and increase the fan speed to maximum.

# AFTER SALES SERVICE

## AFTER SALES SERVICE

1. Free one-year warranty.
2. After the free warranty, you can contact the company to provide maintenance services.
3. The following conditions are not covered by the warranty:
  - a) Damage due to man-made factors
  - b) Damage due to unauthorized disassembly or repair
  - c) Normal wear and tear after usage
  - d) Filter (unless the filter is damaged before used)
  - e) Damage due to improper installation and usage

### Note:

In order to protect your rights, please pay attention to the following information.

1. Please register your purchase online with complete, correct and authentic information within 30 days after purchase to get a one-year free warranty.
2. Keep the purchase receipt or record.
3. Terms and details for the warranty are listed on the online registration page.
4. The appliance should not be used by persons with physical, sensory or mental disabilities and those who lack experience or knowledge (including children), unless they are under the supervision of another person in charge of safety or have provided instructions for the use of the appliance.

# AFTER SALES WARRANTY

## Please visit

[www.aurabeat-tech.com](http://www.aurabeat-tech.com) within 30 days after purchase to register your product to get a one-year warranty.

### 1. Warranty Terms

- a) From the date of purchase, the warranty period is 1 year, during which maintenance service is free of charge (except for force majeure events, external factors).
- b) The complimentary gift (if any) is not covered by the warranty.
- c) Certificate: Purchase receipt, shopping records issued by the company, and receipt are all acceptable.

### 2. Spare parts

Spare parts are provided free of charge during the warranty and charged at market prices after the warranty. The filter is not considered as a spare part. Free warranty is not applicable to filter unless it is damaged.