

INTERLOCK STITCH

High speed interlock stitch machine

C007 L - W 12 2 - 3 56 / CQ

系列 Series

- L 高速型
Ultra high speed
- LX 微油型
Semi-Dry
- JP J型進階款
J plus
- K 基本款
Basic type
- KD 基本款配直驅馬達
K type with DD motor

機種別 Model

- C 筒型
Cylinder bed
- F 平台型
Flat bed
- S 小筒型
Small cylinder bed
- U 超小筒
Ultra Small cylinder bed

網線方式 Covering types

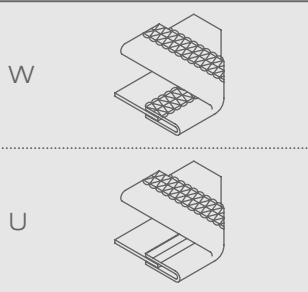

功能 Function

- 12 一般平縫
General plain seaming
- 13 拷下擺
Bottom hemming
- 15 羅紋褲頭鬆緊帶包縫
Tubular rib-fabric elastic waistband attaching
- 16 一般厚布料之平縫
General plain seaming for heavy material
- 22 滾邊車縫
Tape binding
- 32 拷克骨車縫
Overlock-seam covering
- 51 鬆緊帶上帶車縫
Elastic tape attaching
- 52 鬆緊帶附右切刀
Elastic tape attaching with right side fabric trimmer
- 53 環型鬆緊帶車縫
Tubular elastic waistband attaching
- 54 鬆緊帶折縫
Elastic hemming
- 61 褲耳車縫
Belt loop seaming
- 71 雙勾針結構
Double-looper mechanism
- 72 三勾針結構
Triple-looper mechanism
- 81 左切刀修布裝置
Left side fabric trimming
- 82 鬆緊帶上帶邊縫附左切刀
Elastic tape insertion with left side fabric trimmer
- 92 四針六線搭接縫
Four-needle flat seaming

針數

Needle numbers

配件

Device

mm	No.	mm	inch
	32	3.2	1/8
40	4.0	5/32	
48	4.8	3/16	
56	5.6	7/32	
64	6.4	1/4	

針板舌片

Needle plate finger

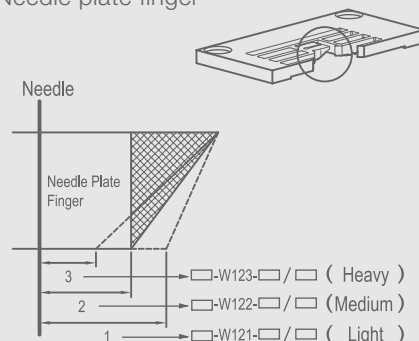

- 1 = 薄布料/細結線(密針)
Light material/Short stitch length
- 2 = 中厚布料/中結線(一般針)
Medium material/Common stitch length
- 3 = 厚布料/粗結線(粗針)
Heavy material/Long stitch length
- 5 = 厚薄通用針板
Heavy to light wide range needle plate

DCL□□ C007L/LX型直驅電控組
Direct-Drive Servo Motor for C007L/LX

DCK□□ C007KD型直驅電控組
Direct-Drive Servo Motor for C007KD

DFK□□ F007KD型直驅電控組
Direct-Drive Servo Motor for F007KD

DSK□□ S007KD, U007, C007JP型直驅電控組
Direct-Drive Servo Motor for S007KD, U007, C007JP

INTERLOCK DD SERVO MOTOR

C007KD-W162-364 / CH / DCK□□

登峰

Ascend to Greatness

造極

C007LX



C007L SERIES

C007L

超高速型繡縫機

Ultra High Speed Cylinder Bed
Interlock Stitch Machine

C007LX

微油超高速型繡縫機

Semi-Dry Ultra High Speed Cylinder
Bed Interlock Stitch Machine

C007L/LX SERIES FEATURES

結合SiRUBA最高端技術的旗艦機種

Flagship model with SiRUBA's state-of-the-art innovation.



內縮式床台

縫製物更靠近針孔，車縫定位精準，車縫時更加順暢就手

The Recessed Machine Bed

With the recessed machine bed, sewing material comes closer to the needle hole, thus provides more precise, easier, and smoother sewing.



短筒座的設計

操作性能優越，可因應廣泛的飾蓋縫紉工程，增加延伸蓋就可以車縫邊或包帶之縫紉工程

Recessed Cylinder Bed

The recessed cylinder bed on the front cover is shortened. The short cylinder has superior operating performance, which can be applied to the extensive covering seam. Hemming or wrapping can be sewed just by increasing the extended cover.



針棒與勾針的新油封結構

新的油封設計強化了機構的油附著力，減少了潤滑油甩出。同時使用高耐磨材料，顯著提高性能及替代

New Oil Sealing Technology

New oil sealing structure used on needle bar and looper mechanism can efficiently avoid oil splash. New wear-resistant material also enhances performance and durability.



新型散熱結構同時降低震動

全新散熱設計提供最佳降溫效率。更穩固的防震結構，提升機械的安定與精度，車縫體驗更為順暢

New Cool Down Technology

Frame structure renewed with better cooling mechanism. Vibration is also reduced to contribute better sewing experience.

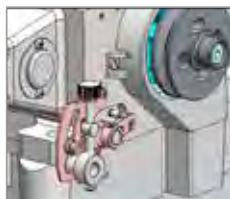

直感式的差動送具調整

差動送具的調整機構設計在縫紉機本體的右後方，於車縫時使用右手直感操作，精準無誤

Easy-to-adjust Differential Feed Dog Design

The differential feed dog adjuster is placed at right side of the operator. Adjust it easily without hesitation.



新設計上夾線裝置

出刀迅速精準·夾線穩定

Brand New Design Upper Thread Gripper

The newly designed upper thread gripper provides fast, precise movement and stable thread gripper.

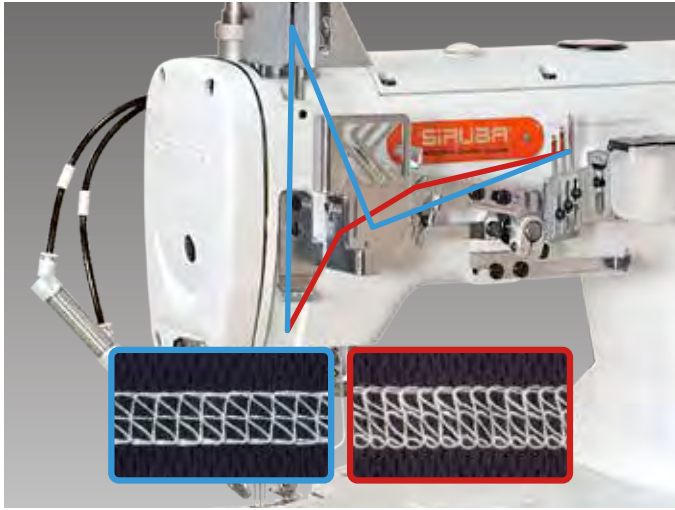

雙天秤挑線控線組

全新雙天秤挑線控線組的設計·縫製厚、薄布料皆適用·車縫適用範圍更廣·適用性更高

Dual Thread Take-up Mechanism

The brand new design of dual thread take-up lever thread tension combination is ideal for both heavy and light fabric. Sewing applicable range is wider and the applicability is higher.

— 中厚布料 (Medium heavy fabric)

— 薄布料 (Light fabric)



C007LX series

無油無慮 Oilless is trouble-free.

SiRUBA 的三針車提供您暢快的縫製體驗

C007LX provides you all new sewing experience.

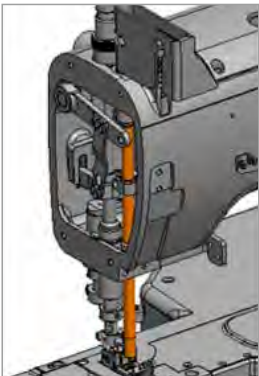

針棒採用特殊的表面處理·縫製時無油污污漬·顯著提高縫製品質·減少重工與縫製品髒污垢·針棒潤滑機構同時再進化·增加零件耐久度

Needle bar mechanism re-designed with new surface treatment, no oil stains and oil splash during operating, greatly increase sewing quality. Needle bar also has better durability due to new lubrication mechanism.

C007L/C007LX										
一般平縫 / 下擺車縫 General Seaming/ Bottom Hemming	C007L-W125-2□□/CH	2	4	3.2/ 4.0/ 4.8	1.4-3.6	0.9~1.4	5/7	UYX128GAS#10	6000	
	C007L-W125-3□□/CH	3	5	4.8/ 5.6/ 6.4	1.4-3.6	0.9~1.4	5/7	UYX128GAS#10	6000	
	C007L-U125-2□□/CH	2	3	3.2/ 4.0/ 4.8	1.4-3.6	0.9~1.4	5/7	UYX128GAS#10	6000	
	C007L-U125-3□□/CH	3	4	4.8/ 5.6/ 6.4	1.4-3.6	0.9~1.4	5/7	UYX128GAS#10	6000	
	C007L-W165-2□□/CH	2	4	4.0/ 4.8	1.4-3.6	0.9~1.4	5/7	UYX128GAS#10	6000	
	C007L-W165-3□□/CH	3	5	4.0/ 4.8	1.4-3.6	0.9~1.4	5/7	UYX128GAS#10	6000	
選購配件 : UTP, UTQ, UTR, UTS, CLA, CMR, CAR/UTP, CAR/UTQ Optional Device: UTP, UTQ, UTR, UTS, CLA, CMR, CAR/UTP, CAR/UTQ										
拷克倒骨蓋縫 Overlock-seam Covering Stitch	C007L-W325-3□□/CC	3	5	5.6/ 6.4	1.4-3.6	0.9~1.4	5/7	UYX128GAS#10	6000	
	C007L-U325-3□□/CC	3	4	5.6/ 6.4	1.4-3.6	0.9~1.4	5/7	UYX128GAS#10	6000	
	C007L-W325-3□□/CE	3	5	5.6/ 6.4	1.4-3.6	0.9~1.4	5/7	UYX128GAS#10	6000	
	C007L-U325-3□□/CE	3	4	5.6/ 6.4	1.4-3.6	0.9~1.4	5/7	UYX128GAS#10	6000	
選購配件 : UTP, UTQ, UTR, UTS, CLA, CMR, CAR/UTP, CAR/UTQ Optional Device: UTP, UTQ, UTR, UTS, CLA, CMR, CAR/UTP, CAR/UTQ										
環型鬆緊帶褲頭接縫 Tubular Jacquard Elastic Waistband Attaching	C007L-W535-232/CR/UTP/CL/RLP/CX	2	4	3.2	1.4-3.6	0.9~1.4	5/7	UYX128GAS#10	5000	
	C007L-W535-3□□/CR/UTP/CL/RLP/CX	3	5	5.6/ 6.4	1.4-3.6	0.9~1.4	5/7	UYX128GAS#10	5000	
	C007L-U535-232/CR/UTP/CL/RLP/CX	2	3	3.2	1.4-3.6	0.9~1.4	5/7	UYX128GAS#10	5000	
	C007L-U535-3□□/CR/UTP/CL/RLP/CX	3	4	5.6/ 6.4	1.4-3.6	0.9~1.4	5/7	UYX128GAS#10	5000	
左切刀修布下擺車縫 Bottom Hemming with Left Side Fabric Trimmer	C007L-W815-2□□/CRL/RL	2	4	4.0/ 4.8	1.4-3.6	0.9~1.4	5/7	UYX128GAS#10	5000	
	C007L-W815-3□□/CRL/RL	3	5	5.6/ 6.4	1.4-3.6	0.9~1.4	5/7	UYX128GAS#10	5000	
	C007L-U815-2□□/CRL/RL	2	3	4.0/ 4.8	1.4-3.6	0.9~1.4	5/7	UYX128GAS#10	5000	
	C007L-U815-3□□/CRL/RL	3	4	5.6/ 6.4	1.4-3.6	0.9~1.4	5/7	UYX128GAS#10	5000	
	C007L-W815A-2□□/CRL/RL	2	4	4.0/ 4.8	1.4-3.6	0.9~1.4	5/7	UYX128GAS#10	5000	
	C007L-W815A-3□□/CRL/RL	3	5	5.6/ 6.4	1.4-3.6	0.9~1.4	5/7	UYX128GAS#10	5000	
	C007L-U815A-2□□/CRL/RL	2	3	4.0/ 4.8	1.4-3.6	0.9~1.4	5/7	UYX128GAS#10	5000	
	C007L-U815A-3□□/CRL/RL	3	4	5.6/ 6.4	1.4-3.6	0.9~1.4	5/7	UYX128GAS#10	5000	
選購配件 : UTP, UTQ, UTR, CMR, CAR/UTP, CAR/UTQ Optional Device: UTP, UTQ, UTR, CMR, CAR/UTP, CAR/UTQ										
鬆緊帶上帶邊縫 附左切刀 Elastic Attaching with Left Fabric Trimmer	C007L-W825-2□□/CRL/CL/RL	2	4	4.0/ 4.8	1.4-3.6	0.9~1.4	5/7	UYX128GAS#10	5000	
	C007L-W825-3□□/CRL/CL/RL	3	5	5.6/ 6.4	1.4-3.6	0.9~1.4	5/7	UYX128GAS#10	5000	
	C007L-U825-2□□/CRL/CL/RL	2	3	4.0/ 4.8	1.4-3.6	0.9~1.4	5/7	UYX128GAS#10	5000	
	C007L-U825-3□□/CRL/CL/RL	3	4	5.6/ 6.4	1.4-3.6	0.9~1.4	5/7	UYX128GAS#10	5000	
	C007L-W825A-2□□/CRL/CL/RL	2	4	4.0/ 4.8	1.4-3.6	0.9~1.4	5/7	UYX128GAS#10	5000	
	C007L-W825A-3□□/CRL/CL/RL	3	5	5.6/ 6.4	1.4-3.6	0.9~1.4	5/7	UYX128GAS#10	5000	
選購配件 : UTP, UTQ, CMR, CAR/UTQ Optional Device: UTP, UTQ, CMR, CAR/UTQ										

CRL用針板類型
Needle Plates for CRL

W8□□ 4排齒 4 rows



W8□□A 5排齒 5 rows



C007K/KD SERIES FEATURES



內縮式床台

縫製物更靠近針孔，車縫定位精準，車縫時更加順暢就手

The Recessed Machine Bed

With the recessed machine bed, sewing material comes closer to the needle hole, thus provides more precise easier, and smoother sewing.



新設計上下切刀組

新設計氣、電動上下切刀組，出刀穩定精確，切線俐落，調整容易

Brand New Top and Under Trimmer

The newly designed pneumatic, electric top & under knife combination have fast, stable and precise. Trims thread neatly. Handy operation, easy to adjust.



針棒與勾針的新油封結構

新的油封設計強化了機構的油附著力，減少了潤滑油甩出。同時使用高耐磨材料，顯著提高性能及替代

New Oil Sealing Technology

New oil sealing structure used on needle bar and looper mechanism can efficiently avoid oil splash. New wear-resistant material also enhances performance and durability.



小型投射LED

小型投射LED照明，穿線或調整機針作業方便（選配）

Small LED Light

Led light, convenient for threading or adjusting the needle. (Optional)



短筒座的設計

操作性能優越，可因應廣泛的飾蓋縫紉工程，增加延伸蓋就可以車縫邊或包帶之縫紉工程

Recessed Cylinder Bed

The recessed cylinder bed on the front cover is shortened. The short cylinder has superior operating performance, which can be applied to the extensive covering seam. Hemming or wrapping can be sewed just by increasing the extended cover.

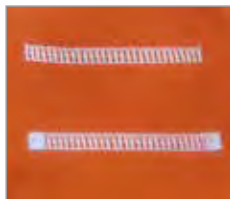

密縫裝置

藉由縮短送具行程，在車縫起始或結束進行密縫的功能，確保縫線不易脫落，提高車縫品質，基本車為腳踏板控制，電動和氣動控制為選配

Condense Stitching Device

By reducing the strokes of feed dog, at the beginning and the end of sewing, condense stitching reinforces the stitches. This enhances the sewing sturdiness and quality. Basic model is controlled by pedal. Electric and pneumatic controls are optional.



新設計上夾線裝置
出刀迅速精準 · 夾線穩定

Brand New Design Upper Thread Gripper

The newly designed upper thread gripper provides fast, precise movement and stable thread gripper.



送具並列式調整鈕設計

[專利] 前送齒及後送齒 · 藉由全新並列式調整鈕設計 · 可獨自調整同步或正逆差動 · 指標刻度方便使用者進行精確調整前後送齒 · 大大提升操作者使用上的便利性

Front and Rear Feed Dog Minute Adjustment

[Patent] Synchronization or forward / reverse differential of front and rear feed dog can be finely adjusted alone by the brand new parallel adjustable feed dog control knobs. Furthermore, the indicator scales is easy for user to adjust the feeding precisely, which improves ease of operation greatly.

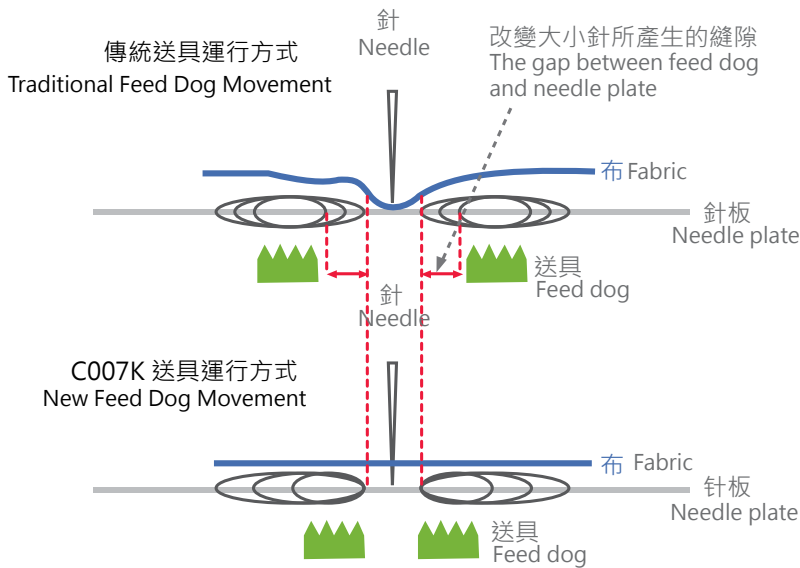

全新移動送齒之傳動設計

[專利] 後、前送齒依據橢圓式運動方式 · 統一由針孔向外運動延伸 · 縫製物可獲得精準穩定送布 · 也不會因為過骨或差動而前、後送具產生間隙 · 影響車縫品質

Brand New Differential Feed Dog Driving Design

[Patent] The front and rear feed dog move elliptically, and centrally, a direct extension from needle hole, thus enable sewing material to get precise and stable feeding. Therefore, the sewing quality will not be affected by the clearance between front and rear feed dog which is resulted from the cross seam or differential action.



雙天秤挑線控線組

全新雙天秤挑線控線組的設計 · 縫製厚、薄布料皆適用 · 車縫適用範圍更廣 · 適用性更高

Dual Thread Take-up Mechanism

The brand new design of dual thread take-up lever thread tension combination is ideal for both heavy and light fabric. Sewing applicable range is wider and the applicability is higher.

- 中厚布料 (Medium heavy fabric)
- 薄布料 (Light fabric)

C1



Model	2	4	3.2/ 4.0/ 4.8	1.4 ~ 3.6	0.3 ~ 2.9	5/7	UYX128GAS#10	6000
C007K-W125-□□□/CH	3	5	4.8/ 5.6/ 6.4	1.4 ~ 3.6	0.3 ~ 2.9	5/7	UYX128GAS#10	6000
C007K-W162-□□□/CH	2	4	4.0/ 4.8	1.4 ~ 3.6	0.3 ~ 2.9	5/7	TVX5#14~#16	6000
	3	5	4.8/ 5.6/ 6.4	1.4 ~ 3.6	0.3 ~ 2.9	5/7	TVX5#14~#16	6000
C007K-W125-□□□/CH-3M	3	5	5.6/ 6.4	1.4 ~ 3.6	0.3 ~ 2.9	5/7	UYX128GAS#10	6000
C007KD-W125-□□□/CH/DC□	2	4	3.2/ 4.0/ 4.8	1.4 ~ 3.6	0.3 ~ 2.9	5/7	UYX128GAS#10	6000
	3	5	4.8/ 5.6/ 6.4	1.4 ~ 3.6	0.3 ~ 2.9	5/7	UYX128GAS#10	6000
C007KD-W162-□□□/CH/DC□	2	4	4.0/ 4.8	1.4 ~ 3.6	0.3 ~ 2.9	5/7	TVX5#14~#16	6000
	3	5	4.8/ 5.6/ 6.4	1.4 ~ 3.6	0.3 ~ 2.9	5/7	TVX5#14~#16	6000
C007KD-W125-□□□/CH-3M/DC□	3	5	5.6/ 6.4	1.4 ~ 3.6	0.3 ~ 2.9	5/7	UYX128GAS#10	6000



C007K-W125-356/CH/UTP

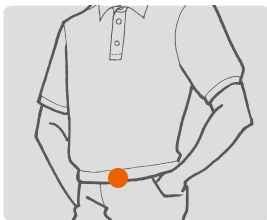

一般平縫 / 下擺車

本機型為雙面飾繃縫筒車之基本機型，可裝配附件進行多種功能車縫
例如：內衣褲、運動衫接縫及下擺車縫(附可調式下擺車縫組)

GENERAL SEAMING / BOTTOM HEMMING

Basic model of interlock stitch machine with double side cover-stitching. It is available for various sewing by optional devices. Such as plain seaming and bottom hemming for underwears, sportswears, etc... (equipped with adjustable hemming set)

W125 : 薄中厚多功能對應針板

W162 : 高行程

W125 : Light / Medium / Heavy Material Multi-function

W162 : High needle bar stroke

選購配件 OPTIONAL DEVICE

UTP, UTQ, UTR, UTS, CLA, CMR, CAR/UTP, CAR/UTQ

C2

C007K-W815(A)-□□□/ CRL	2	4	3.2/ 4.0/ 4.8	1.4 ~ 3.6	0.3 ~ 2.9	5/7	UYX128GAS#10	4500
	3	5	5.6/ 6.4	1.4 ~ 3.6	0.3 ~ 2.9	5	UYX128GAS#10	4500
C007KD-W815(A)-□□□/ CRL/ DC□	2	4	3.2/ 4.0/ 4.8	1.4 ~ 3.6	0.3 ~ 2.9	5/7	UYX128GAS#10	4500
	3	5	5.6/ 6.4	1.4 ~ 3.6	0.3 ~ 2.9	5	UYX128GAS#10	4500



C007K-W815-356/
CRL

適用規格 APPLICABLE SPEC.
W815, U815

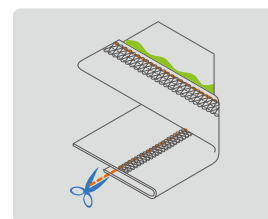
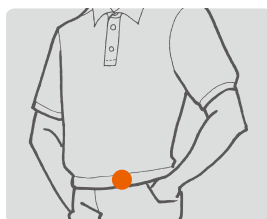

左切刀修布下擺車縫

附左切刀修齊布邊後，再進行下擺車縫工程，適用於車縫T恤、汗衫之下擺等

BOTTOM HEMMING WITH LEFT SIDE FABRIC TRIMMER

Left hand side fabric trimming before hemming. For sleeve opening and bottom of underwears, T-shirt, or sportswears, etc...

W8□□

W8□□A

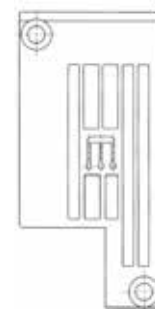
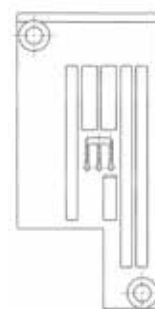

選購配件 OPTIONAL DEVICE
UTP, UTQ, UTR, CL, CMR, CAR/UTP, CAR/UTQ

C3

C007K-U131-256/CHK/UTQ	2	3	5.6	1.4 ~ 3.6	0.3 ~ 2.9	5	UYX128GAS	6000
C007KD-U131-256/CHK/UTQ/ DC□	2	3	5.6	1.4 ~ 3.6	0.3 ~ 2.9	5	UYX128GAS	6000



C007K-U131-256/
CHK/UTQ

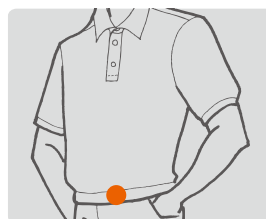

半自動下擺車縫

T恤、內衣及兒童服飾之下擺及袖口之車縫，可隨需要調整下擺飾縫組寬度，操作簡單快捷
CHK-A1 用於一般機型
CHK-UT 用於自動切線機型

SEMI-AUTO HEMMING

Suitable for bottom hemming of T-shirt, underwears, cuff of children's garments, etc... Able to adjust the width of hemming set to fit demands, easy operation.

CHK-A1 is for normal type machine
CHK-UT is for auto trimmer type machine

C4



C007K-W222-□□□/□□	2	4	4.0/ 4.8	1.4 ~ 3.6	0.3 ~ 2.9	5/7	UYX128GAS#10	6000
	3	5	5.6/ 6.4	1.4 ~ 3.6	0.3 ~ 2.9	5/7	UYX128GAS#10	6000
C007KD-W222-□□□/□□/□□	2	4	4.0/ 4.8	1.4 ~ 3.6	0.3 ~ 2.9	5/7	UYX128GAS#10	6000
	3	5	5.6/ 6.4	1.4 ~ 3.6	0.3 ~ 2.9	5/7	UYX128GAS#10	6000
C007K-W222-□□□/□□□	3	5	5.6	1.4 ~ 3.6	0.3 ~ 2.9	5	TVX5#14	5000
C007KD-W222-□□□/□□□/□□	3	5	5.6	1.4 ~ 3.6	0.3 ~ 2.9	5	TVX5#14	5000



C007K-W222-356/CQ



C007K-W222-356/CQA

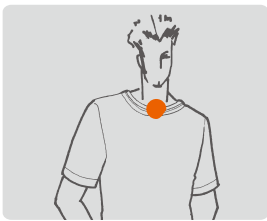

CQ

CQ:上帶滾邊車縫

適用於內衣褲、T恤之領口、褲管口等上帶滾邊之車縫工程

註：滾邊器尺寸為入布端寬1-3/8"，出布時折成三折，出口端成品寬為1/2"

CQ:TAPE BINDING

For tape binding on openings of leg or neck of underwears, T-shirts, etc...

Remark : Binder's opening size is 1-3/8" wide and finished size is 1/2" wide in three folds.

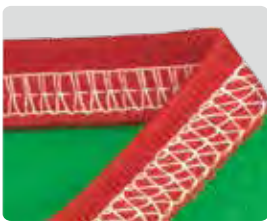

CQA:中厚毯上帶滾邊車縫

適用於中厚毯上帶滾邊之車縫工程

註：滾邊器尺寸為入布端寬72mm，出布時折成二折，出口端成品寬為36mm

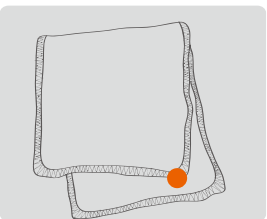

CQA

CQA:BLANKET CARPET TAPE BINDING

For medium and heavy material tape binding.

Remark : Binder's opening size is 72mm wide and finished size is 36mm wide in two folds.

選購配件 OPTIONAL DEVICE
CLA, FA

C5



C007K-W322-3□□/CC	3	5	5.6/ 6.4	1.4 ~ 3.6	0.3 ~ 2.9	5	UYX128GAS#10	6000
C007K-W322A-3□□/CC	3	5	5.6/ 6.4	1.4 ~ 3.6	0.3 ~ 2.9	5	UYX128GAS#10	6000
C007K-W322-3□□/CE	3	5	5.6/ 6.4	1.4 ~ 3.6	0.3 ~ 2.9	5	UYX128GAS#10	6000
C007KD-W322-3□□/CC/DC□	3	5	5.6/ 6.4	1.4 ~ 3.6	0.3 ~ 2.9	5	UYX128GAS#10	6000
C007KD-W322A-3□□/CC/DC□	3	5	5.6/ 6.4	1.4 ~ 3.6	0.3 ~ 2.9	5	UYX128GAS#10	6000
C007KD-W322-3□□/CE/DC□	3	5	5.6/ 6.4	1.4 ~ 3.6	0.3 ~ 2.9	5	UYX128GAS#10	6000



C007K-W322-356/CC



C007K-W322A-356/CC



C007K-W322-356/CE

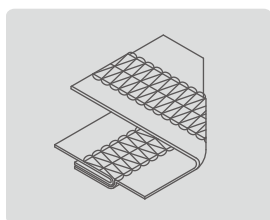

CC

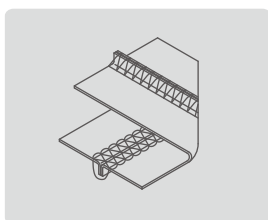

CE



CC

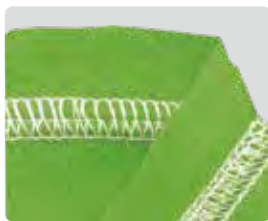

CE

拷克倒骨蓋縫

CC 倒骨型：適用於4線包縫之蓋縫

W322A為兩用型，針板與送具改用W122規格，並附CH組

CE 立骨型：適用於3線包縫之蓋縫

配件盒另附有CC倒骨規格之牛角（導布片）

OVERLOCK-SEAM COVERING STITCH

CC Fold-down type：For 4-thread overlock-seam covering stitch

W322A is dual-purpose specification, which is with W122's needle plate, feed dog and CH set.

CE Flattening type：For 3-thread overlock-seam covering stitch,

and an extra guide of overlock-seam (CC specification, fold-down type) is included in the accessory box.

選購配件 OPTIONAL DEVICE
UTP, UTQ, UTR, UTS, CLA, CMR, CAR/UTP, CAR/UTQ

C6

C007K(D)-W515-□□□/FE/(DC□)	2	4	4.0/ 4.8	1.4 ~ 3.6	0.3 ~ 2.9	5	UYX128GAS#10	4500	
	3	5	5.6/ 6.4	1.4 ~ 3.6	0.3 ~ 2.9	5	UYX128GAS#10	4500	
C007K-W515-□□□/FFC	2	4	4.0/ 4.8	1.4 ~ 3.6	0.3 ~ 2.9	5	UYX128GAS#10	4500	
	3	5	5.6/ 6.4	1.4 ~ 3.6	0.3 ~ 2.9	5	UYX128GAS#10	4500	
C007K-W515-□□□/SMK	2	4	4.0/ 4.8	1.4 ~ 3.6	0.3 ~ 2.9	5	UYX128GAS#10	4500	
	3	5	5.6/ 6.4	1.4 ~ 3.6	0.3 ~ 2.9	5	UYX128GAS#10	4500	
C007K-W515-□□□/STC	2	4	4.0/ 4.8	1.4 ~ 3.6	0.3 ~ 2.9	5	UYX128GAS#10	4500	
	3	5	5.6/ 6.4	1.4 ~ 3.6	0.3 ~ 2.9	5	UYX128GAS#10	4500	



C007K-W515-356/FE



C007K-W515-356/FFC

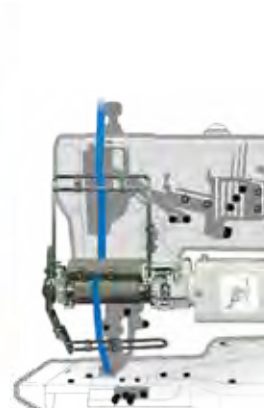

SMK



STC

鬆緊帶 / 蕾絲鬆緊帶上帶車

經由上送帶裝置，控制長度與張力，提高車縫品質，如女用內衣褲之鬆緊帶或蕾絲鬆緊帶車縫

FFC: 機械式送帶

FE: 簡易電子式送帶

SMK: 電子計數式送帶

SMK1-C-01 附定位器，適合簡易伺服或離合器馬達

SMK1-C-02 以中繼線，連接伺服馬達

STC: 張力控制式送帶

STC1-U-01 附定位器，適合簡易伺服或離合器馬達

STC1-U-02 以中繼線，連接伺服馬達

ELASTIC / LACE ATTACHING

Top feeding devices ensure even length and tension controlled by electric digital controller, for elastic or lace attaching smoothly and properly on women's underwears.

FFC: Mechanic type tape feeding.

FE: Simple electric type tape feeding.

SMK: Electric metering type tape feeding

SMK1-C-01 with synchronizer for simple servo motor or clutch motor

SMK1-C-02 Connected to servo motor by encoder cable.

STC: Tension sensor type tape feeding

STC1-U-01 with synchronizer for simple servo motor or clutch motor

STC1-U-02 Connected to servo motor by encoder cable.

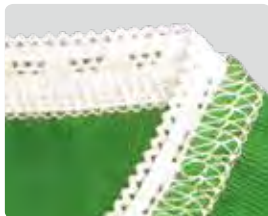
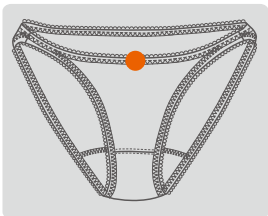

選購配件 OPTIONAL DEVICE

CL, LF-A, LS-A

C7



Model	2	4	3.2/ 4.0/ 4.8	1.4 ~ 3.6	0.3 ~ 2.9	5	UYX128GAS#11	4500
C007K-W525-□□□/CR/FE	2	4	3.2/ 4.0/ 4.8	1.4 ~ 3.6	0.3 ~ 2.9	5	UYX128GAS#11	4500
	3	5	4.8/ 5.6/ 6.4	1.4 ~ 3.6	0.3 ~ 2.9	5	UYX128GAS#11	4500
C007K-W525-□□□/CR/FFC	2	4	3.2/ 4.0/ 4.8	1.4 ~ 3.6	0.3 ~ 2.9	5	UYX128GAS#11	4500
	3	5	4.8/ 5.6/ 6.4	1.4 ~ 3.6	0.3 ~ 2.9	5	UYX128GAS#11	4500
C007K-W525-□□□/CR/SMK	2	4	3.2/ 4.0/ 4.8	1.4 ~ 3.6	0.3 ~ 2.9	5	UYX128GAS#11	4500
	3	5	4.8/ 5.6/ 6.4	1.4 ~ 3.6	0.3 ~ 2.9	5	UYX128GAS#11	4500
C007K-W525-□□□/CR/STC	2	4	3.2/ 4.0/ 4.8	1.4 ~ 3.6	0.3 ~ 2.9	5	UYX128GAS#11	4500
	3	5	4.8/ 5.6/ 6.4	1.4 ~ 3.6	0.3 ~ 2.9	5	UYX128GAS#11	4500



C007K-W525-356/CR/FE



C007K-W525-356/CR/FFC



SMK



STC

鬆緊帶 / 蕾絲鬆緊帶上帶車縫附右切刀

經由上送帶裝置，控制長度與張力，附右切刀修布裝置，能於車縫前將布修齊，更能提高車縫品質，如女用內衣褲之鬆緊帶或蕾絲鬆緊帶車縫

FFC: 機械式送帶

F E : 簡易電子式送帶

SMK: 電子計數式送帶

SMK1-C-01 附定位器，適合簡易伺服或離合器馬達

SMK1-C-02 以中繼線，連接伺服馬達

STC: 张力控制式送帶

STC1-U-01 附定位器，適合簡易伺服或離合器馬達

STC1-U-02 以中繼線，連接伺服馬達

ELASTIC / LACE ATTACHING WITH RIGHT FABRIC TRIMMER

Top feeding devices ensure even length and tension controlled by electric digital controller, with right side fabric trimmer for elastic or lace attaching smoothly and properly on women's underwears.

FFC: Mechanic type tape feeding.

F E : Simple electric type tape feeding.

SMK: Electric metering type tape feeding

SMK1-C-01 with synchronizer for simple servo motor or clutch motor

SMK1-C-02 Connected to servo motor by encoder cable.

STC: Tension sensor type tape feeding

STC1-U-01 with synchronizer for simple servo motor or clutch motor

STC1-U-02 Connected to servo motor by encoder cable.

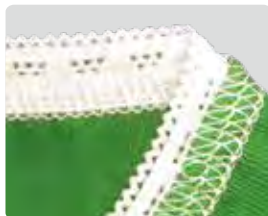
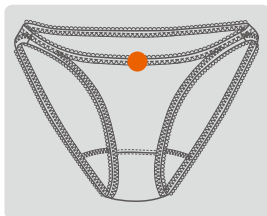
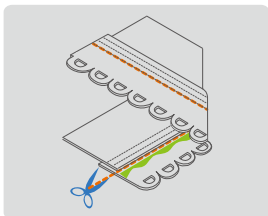

選購配件 OPTIONAL DEVICE

CL, LF-A, LS-A, CSA, CSB



C007K(D)-W535-□□□/CR/CX/UTP/RLP/(DC□) *1	2	4	3.2/ 4.0/ 4.8	1.4 ~ 3.6	0.3 ~ 2.9	5	UYX128GAS#11	4500
	3	5	4.8/ 5.6/ 6.4	1.4 ~ 3.6	0.3 ~ 2.9	5	UYX128GAS#11	4500
C007K(D)-W535-□□□/CR/CX/UTR/RLP/(DC□) *2	2	4	3.2/ 4.0/ 4.8	1.4 ~ 3.6	0.3 ~ 2.9	5	UYX128GAS#11	4500
	3	5	4.8/ 5.6/ 6.4	1.4 ~ 3.6	0.3 ~ 2.9	5	UYX128GAS#11	4500



C007K-W535-356/CR/CX/CL/UTP

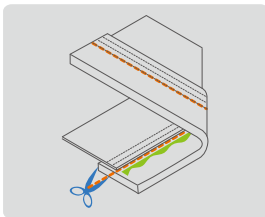
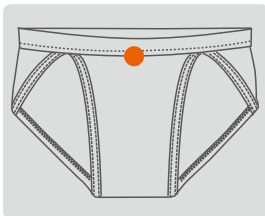

環型鬆緊帶褲頭接縫附右切刀修布邊

將環型平織鬆緊帶與衣物接縫適用於男女內褲褲腰之鬆緊帶縫合，配合右切刀修布裝置，更能提高縫製品質

- *1: 氣動切線，含氣動式吸布屑組
- *2: 電動切線，需另外搭配吸風馬達 (CSA或CSB)

TUBULAR JACQUARD ELASTIC WAISTBAND ATTACHING WITH RIGHT SIDE FABRIC TRIMMER

For tubular elastic or lace waistband attaching on men's or women's brief, with right hand side fabric trimmer to increase sewing quality and efficiency.

- *1: Pneumatic thread trimmer, including fabric waste suction set
- *2: Electric thread trimmer, an optional suction motor (CSA or CSB) is required.

RLP



選購配件 OPTIONAL DEVICE
CL* , CAR/UTQ , CMR , CSA , CSB

- *建議採用CL後拉輪，以提升鬆緊帶車縫效率
- *CL rear puller is recommended for elastic band attaching

C9



C007K-W825-□□□/CRL/CHP(CY)/UTP	2	4	3.2/ 4.0/ 4.8	1.4 ~ 3.6	0.3 ~ 2.9	5	UYX128GAS#10	4500
	3	5	5.6/ 6.4	1.4 ~ 3.6	0.3 ~ 2.9	5	UYX128GAS#10	4500
C007KD-W825-□□□/CRL/CHP(CY)/UTP/DC□	2	4	3.2/ 4.0/ 4.8	1.4 ~ 3.6	0.3 ~ 2.9	5	UYX128GAS#10	4500
	3	5	5.6/ 6.4	1.4 ~ 3.6	0.3 ~ 2.9	5	UYX128GAS#10	4500



C007K-W825-356/CRL/CL/CHP/UTP

**[二合一]氣動式下擺車縫 / 環型鬆緊帶折縫
附左切刀修布邊功能**

氣動式布料導邊器能將布料及鬆緊帶順暢的捲折，此外左切刀切齊後再進行縫紉，可增加包縫工程之品質與效率，適用於男內褲、運動褲等褲頭鬆緊帶包縫

**[2 IN 1]
PNEUMATIC HEMMING / TUBULAR ELASTIC TAPE HEMMING WITH LEFT EDGE TRIMMER**

With pneumatic driving folder to fold fabric and insert elastic smoothly, left hand side fabric trimming before hemming increases sewing quality & efficiency. For hemming sleeve opening and bottom of underwears, T-shirts, or sportswears, etc...

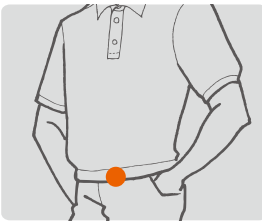

CHP (CRL 163)
氣動式下擺車縫

Pneumatic Hemming



CY (CRL178-A)
氣動式環型鬆緊帶折縫

Pneumatic Tubular Elastic Tape Hemming

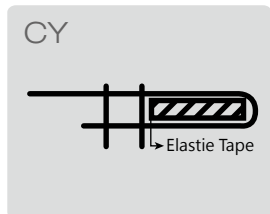
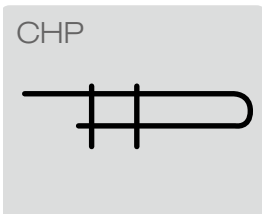

適用規格 APPLICABLE SPEC
W825 , U825
選購配件 OPTIONAL DEVICE
CL* , RL , UTQ , CMR , CAR/UTQ

*建議採用CL後拉輪，以提升鬆緊帶車縫效率

*CL rear puller is recommended for elastic band attaching

C10

								
C007K-W152-356/CZ/RLQ	3	5	5.6	1.4 ~ 3.6	0.3 ~ 2.9	5	UYX128GAS#10	6000
C007K-W152-364/CZ/RLQ	3	5	6.4	1.4 ~ 3.6	0.3 ~ 2.9	5	UYX128GAS#10	6000
C007K-W152-356/CZP/RLQ	3	5	5.6	1.4 ~ 3.6	0.3 ~ 2.9	5	UYX128GAS#10	6000
C007K-W152-364/CZP/RLQ	3	5	6.4	1.4 ~ 3.6	0.3 ~ 2.9	5	UYX128GAS#10	6000
C007KD-W152-356/CZ/RLQ/DC□	3	5	5.6	1.4 ~ 3.6	0.3 ~ 2.9	5	UYX128GAS#10	6000
C007KD-W152-364/CZ/RLQ/DC□	3	5	6.4	1.4 ~ 3.6	0.3 ~ 2.9	5	UYX128GAS#10	6000
C007KD-W152-356/CZP/RLQ/DC□	3	5	5.6	1.4 ~ 3.6	0.3 ~ 2.9	5	UYX128GAS#10	6000
C007KD-W152-364/CZP/RLQ/DC□	3	5	6.4	1.4 ~ 3.6	0.3 ~ 2.9	5	UYX128GAS#10	6000



C007K-W152-356/CZ/UTP

環型羅紋褲頭鬆緊帶包縫

CZ:氣動式 / CZP:膝動式

將環型羅紋鬆緊帶縫入原體，適用於男女內褲、褲腰之羅紋鬆緊帶包縫再配合自動切線裝置及筒型衣物撐開滾輪組，更能提高縫製效率
註：本機型標準配備二折式導布片，可另訂三折式導布片

TUBULAR ELASTIC WAISTBAND ATTACHING

CZ:PNEUMATIC TYPE / CZP: MANUAL TYPE

Attaching tubular elastic tape onto waistband, suitable for briefs. With auto-trimming and tubular extending roller can increase sewing quality and efficiency.

Remark : Two fold fabric guide is standard, three fold fabric guide is optional.

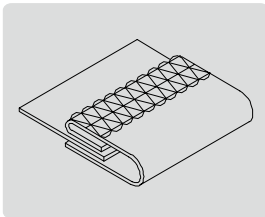
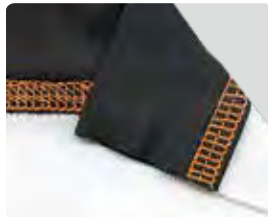
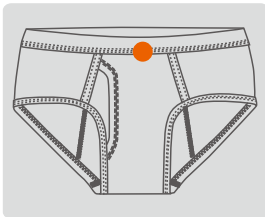

三折 3-Fold
(CZ01K,CZ03K)

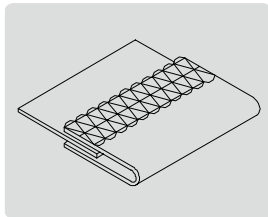

兩折 2-Fold
(CZ21K,CZ22K)

RLQ



機型 MODEL	選購配件 OPTIONAL DEVICE
CZ	CL*, UTP, UTQ, CMR, CAR/UTP, CAR/UTQ
CZP	CL*, UTP, UTQ, UTR, UTS, CMR, CAR/UTP, CAR/UTQ

*建議採用CL後拉輪，以提升鬆緊帶車縫效率

*CL rear puller is recommended for elastic band attaching

C11

								
C007K-W542-□□□/CFC	2	4	4.0/ 4.8	1.4 ~ 3.6	0.3 ~ 2.9	5/7	UYX128GAS#11	6000
	3	5	5.6/ 6.4	1.4 ~ 3.6	0.3 ~ 2.9	5/7	UYX128GAS#11	6000
C007K-W542-□□□/SMK	2	4	4.0/ 4.8	1.4 ~ 3.6	0.3 ~ 2.9	5/7	UYX128GAS#11	6000
	3	5	5.6/ 6.4	1.4 ~ 3.6	0.3 ~ 2.9	5/7	UYX128GAS#11	6000
C007K-W542-□□□/STC	2	4	4.0/ 4.8	1.4 ~ 3.6	0.3 ~ 2.9	5/7	UYX128GAS#11	6000
	3	5	5.6/ 6.4	1.4 ~ 3.6	0.3 ~ 2.9	5/7	UYX128GAS#11	6000



C007K-W542-356/CFC/CL

鬆緊帶折縫

由下送帶配件，能有效控制鬆緊帶之鬆緊度，配合三折或二折折布喇叭及鬆緊帶壓縫，可精確完美的進行短褲、內褲等褲腳及褲頭之鬆緊帶折縫

CFC: 機械式送帶

SMK: 電子計數式送帶

SMK1-D-01 附定位器，適合簡易伺服或離合器馬達

SMK1-D-02 以中繼線，連接伺服馬達

STC: 張力控制式送帶

STC1-B-01 附定位器，適合簡易伺服或離合器馬達

STC1-B-02 以中繼線，連接伺服馬達

ELASTIC HEMMING

Elastic hemming evenly length and elasticity is controlled by tape feeding device. Great for seam covering with two or three plies hemming binder on elastic for waistband or leg opening of briefs and shorts, etc...

CFC: Mechanic type tape feeding

SMK: Electric metering type tape feeding

SMK1-D-01 with synchronizer for simple servo motor or clutch motor

SMK1-D-02 Connected to servo motor by encoder cable

STC: sensor type tape feeding

STC1-B-01 with synchronizer for simple servo motor or clutch motor

STC1-B-02 Connected to servo motor by encoder cable

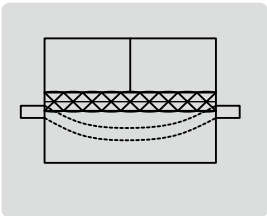
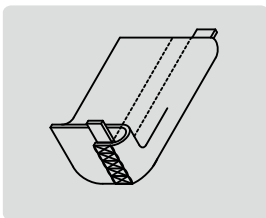
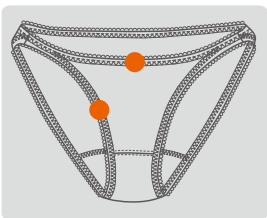

SMK



STC

可選擇之折布喇叭 Optional Binder			
喇叭型式 Binder Type	機型 Model	喇叭代號 Binder No.	成品尺寸 Finished Size
	2	B523	9mm
	2A	B523A	12mm
	3	B524	9mm
	3A	B524A	12mm

選購配件 OPTIONAL DEVICE
FH, CL*

*建議採用CL後拉輪，以提升鬆緊帶車縫效率

*CL rear puller is recommended for elastic band attaching

C12

								
C007K-W925-456/CW	4	6	5.6	1.4 ~ 3.6	0.3 ~ 2.9	5	SMX1014B#10	6000
C007K-W925-460/CW	4	6	6.0	1.4 ~ 3.6	0.3 ~ 2.9	5	SMX1014B#10	6000
C007K-W925-464/CW	4	6	6.4	1.4 ~ 3.6	0.3 ~ 2.9	5	SMX1014B#10	6000
C007KD-W925-456/CW/DC□	4	6	5.6	1.4 ~ 3.6	0.3 ~ 2.9	5	SMX1014B#10	6000
C007KD-W925-460/CW/DC□	4	6	6.0	1.4 ~ 3.6	0.3 ~ 2.9	5	SMX1014B#10	6000
C007KD-W925-464/CW/DC□	4	6	6.4	1.4 ~ 3.6	0.3 ~ 2.9	5	SMX1014B#10	6000



C007K-W925-456/CW

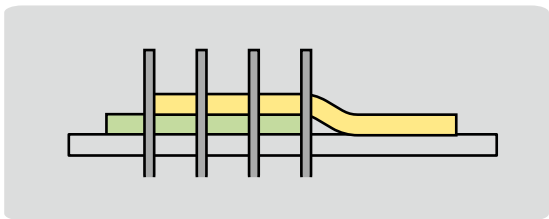
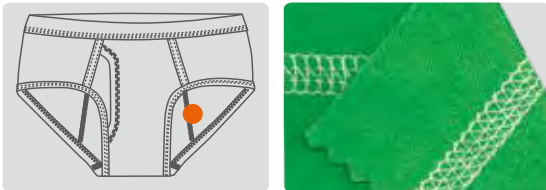

四針六線搭接縫

適用於一般內衣褲二片布接縫處之接縫和補強，附有專屬之導邊器，可使二片布順暢縫合

FOUR-NEEDLE FLAT SEAMING

For flat seaming 2 pieces of fabric. Equipped with fabric guide for easy operation.

CW



選購配件 OPTIONAL DEVICE

UTQ, UTS, CL, CMR, CAR/UTQ

C13



C007KD-W125-□□□/FFT/CH/DC□	2	4	4.0/4.8	1.4 ~ 3.6	0.3 ~ 2.9	1~5.5	5	UYX128GAS#10	4500
	3	5	5.6/6.4	1.4 ~ 3.6	0.3 ~ 2.9	1~5.5	5	UYX128GAS#10	4500
C007KD-W131-□□□/FFT/CH/DC□	2	4	4.0/4.8	1.4 ~ 3.6	0.3 ~ 2.9	1~5.5	5	UYX128GAS#10	4500
	3	5	5.6/6.4	1.4 ~ 3.6	0.3 ~ 2.9	1~5.5	5	UYX128GAS#10	4500
C007KD-W132-□□□/FFT/CH/DC□	2	4	4.0/4.8	1.4 ~ 3.6	0.3 ~ 2.9	1~5.5	5	UYX128GAS#10	4500
	3	5	5.6/6.4	1.4 ~ 3.6	0.3 ~ 2.9	1~5.5	5	UYX128GAS#10	4500
C007KD-W815A-□□□/FFT/CRL/DC□	2	4	4.0/4.8	1.4 ~ 3.6	0.3 ~ 2.9	1~5.5	5	UYX128GAS#10	4500
	3	5	5.6/6.4	1.4 ~ 3.6	0.3 ~ 2.9	1~5.5	5	UYX128GAS#10	4500
C007KD-U815A-□□□/FFT/CRL/DC□	2	4	4.0/4.8	1.4 ~ 3.6	0.3 ~ 2.9	1~5.5	5	UYX128GAS#10	4500
	3	5	5.6/6.4	1.4 ~ 3.6	0.3 ~ 2.9	1~5.5	5	UYX128GAS#10	4500
C007KD-W812A-□□□/FFT/CRL/CW/DC□	4	6	5.6/6.0/6.4	1.4 ~ 3.6	0.3 ~ 2.9	1~5.5	5	UYX128GAS#10	4500



FFT 上送布功能

專利優化前後移動送具之結構設計，有效送布行程大，車縫送布更穩定

FFT TOP FEEDING FUNCTION

Back and forth moving feed dog is designed by patent and improved mechanism. The effective feeding stroke is bigger, and fabric feeding is more stable.

選購配件 OPTIONAL DEVICE
UTP, UTR

CRL用針板類型 Needle Plates for CRL

W8□□

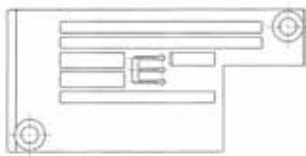

4排齒 4 rows

W8□□A

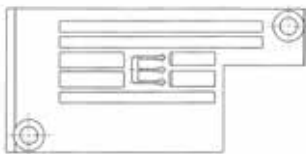

5排齒 5 rows

X Brand

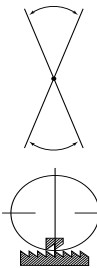

Y Brand

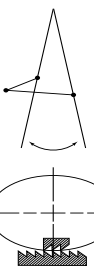

SIRUBA

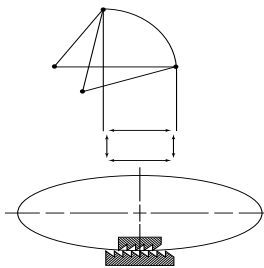

U007 SERIES FEATURES



U007 直驅超小筒型繙縫機 Ultra Small cylinder bed Interlock Stitch Machine



128mm角逐業界最細的小筒設計，過往縫製困難的童裝袖口也可輕易車縫

128mm top-class small cylinder bed design. Conventionally difficult-to-sew small diameter tubular parts of children's clothing can be easily operated.

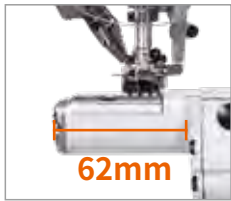

斜面筒嘴設計，縫製衣物著脫容易；筒身長62mm，方便長袖衣物套入車縫

Sharp entrance design allows quick placement/removal of material. 62mm cylinder length makes sewing long sleeve cuffs easily.



圓形粗細針縫目調整鈕的設計，隨心所欲精確調整縫目長短

Circular stitch length adjustment button, easily to adjust stitch length.



自動切線系列新設計氣/電動上下切刀組，出刀迅速穩定精準，切線俐落，輕順低噪音調整容易

Auto trimmer with newly designed pneumatic / electric trimming system, trims precisely and stably, reduce sound and easy to adjust.

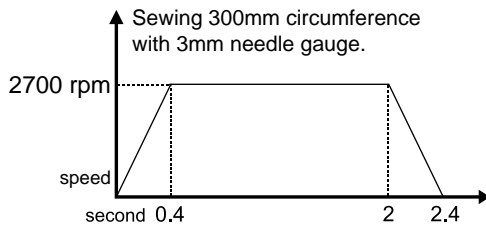

300mm圓周長不需3秒即可完工，2700rpm是對應小筒車縫的完美速度

Just take less than 3 seconds to complete 300mm circumference sewing; 2700rpm is the perfect speed for ultra small cylinder.

規格

SPECIFICATIONS

U007						
				mm	Needle No.	S.P.M. (Max)
U007-W125-2□□/UTT(UTU)	2	4	4.0/4.8	5	UXY128GAS#10	2700
U007-W125-3□□/UTT(UTU)	3	5	5.6/6.4	5	UXY128GAS#10	2700
U007-W125-2□□/UTX(UTY)	2	4	4.0/4.8	5	UXY128GAS#10	2700
U007-W125-3□□/UTX(UTY)	3	5	5.6/6.4	5	UXY128GAS#10	2700

C007JP SERIES FEATURES



應愛好者要求，送具調整回歸過往C007J方式，同時承襲三針車優良進化

C007J comes back due to many customers' request. The feeding mechanism is J type. Also, it is improved with new trimmer and thread take-up lever.



雙天秤挑線控線組

全新雙天秤挑線控線組的設計，縫製厚、薄布料皆適用，車縫適用範圍更廣，適用性更高

Dual Thread Take-up Mechanism

The brand new design of dual thread take-up lever thread tension combination is ideal for both heavy and light fabric. Sewing applicable range is wider and the applicability is higher.

規格

SPECIFICATIONS

C007JP									
一般平縫 / 下擺車縫 General Seaming/ Bottom Hemming	C007JP-W125-2□□/CH	2	4	4.0/ 4.8/ 5.6	1.4-3.6	0.3~2.9	5/7	UYX128GAS#10	6000
	C007JP-W125-3□□/CH	3	5	5.6/ 6.4	1.4-3.6	0.3~2.9	5/7	UYX128GAS#10	6000
左切刀修布下擺車縫 Bottom Hemming with Left Side Fabric	C007JP-W815-2□□/CRL/RL	2	4	4.0/ 4.8	1.4-3.6	0.3~2.9	5/7	UYX128GAS#10	6000
	C007JP-W815-3□□/CRL/RL	3	5	5.6/ 6.4	1.4-3.6	0.3~2.9	5/7	UYX128GAS#10	6000
	C007JP-U815-2□□/CRL/RL	2	3	4.0/ 4.8	1.4-3.6	0.3~2.9	5/7	UYX128GAS#10	6000
	C007JP-U815-3□□/CRL/RL	3	4	5.6/ 6.4	1.4-3.6	0.3~2.9	5/7	UYX128GAS#10	6000
	C007JP-W815A-2□□/CRL/RL	2	4	4.0/ 4.8	1.4-3.6	0.3~2.9	5/7	UYX128GAS#10	6000
	C007JP-W815A-3□□/CRL/RL	3	5	5.6/ 6.4	1.4-3.6	0.3~2.9	5/7	UYX128GAS#10	6000
	C007JP-U815A-2□□/CRL/RL	2	3	4.0/ 4.8	1.4-3.6	0.3~2.9	5/7	UYX128GAS#10	6000
	C007JP-U815A-3□□/CRL/RL	3	4	5.6/ 6.4	1.4-3.6	0.3~2.9	5/7	UYX128GAS#10	6000
鬆緊帶上帶邊縫 附左切刀 Elastic Attaching with Left Fabric Trimmer	C007JP-W825-2□□/CRL/CL/RL	2	4	4.0/ 4.8	1.4-3.6	0.3~2.9	5/7	UYX128GAS#10	6000
	C007JP-W825-3□□/CRL/CL/RL	3	5	5.6/ 6.4	1.4-3.6	0.3~2.9	5/7	UYX128GAS#10	6000
	C007JP-U825-2□□/CRL/CL/RL	2	3	4.0/ 4.8	1.4-3.6	0.3~2.9	5/7	UYX128GAS#10	6000
	C007JP-U825-3□□/CRL/CL/RL	3	4	5.6/ 6.4	1.4-3.6	0.3~2.9	5/7	UYX128GAS#10	6000

S007K/KD SERIES FEATURES



自動切線系列新設計上夾線裝置，出刀迅速精準，夾線穩定

Auto trimmer with newly designed upper thread holder, trims precisely and stably.



三合一壓骨，倒骨，折下擺，更換作業組裝方便，多樣化功能，提供生產廠商高效率低成本

3-in-1 model, including bottom hemming/seam covering/overturnd seam covering, provides high efficiency at less cost.



超小筒徑圓周只有180毫米，車縫小孔徑圓筒針織物，更加方便就手

The small cylinder designed with 180 mm, the extremely small circumference makes sewing operation smoother.



外置式底線分線盤，置於機體前方，調整容易，拆裝方便，可輕易清除絞線

Front exposed looper thread take-up mechanism makes cleaning and adjusting more convenient. After fine tuning the looper thread eyelet holder, sewing can be more accurate.



調整式進布誘導器，活動式壓腳，車縫適用性更廣

Adjustable folder, flexible presser foot, able to accomodate wider range of sewing items.



超短筒的設計，筒邊至中針距離只有31毫米，採密封式之側蓋設計，操作方便順暢

Extremely small tubule design, the distance from cylinder edge to middle needle is only 31 mm. Sealed side cover makes operation more convenient.



密縫裝置

藉由縮短送具行程，在車縫起始或結束進行密縫的功能，確保縫線不易脫落，提高車縫品質，基本車為腳踏板控制，電動和氣動控制為選配

Condense Stitching Device

By reducing the strokes of feed dog, at the beginning and the end of sewing, condense stitching reinforces the stitches. This enhances the sewing sturdiness and quality. Basic model is controlled by pedal. Electric and pneumatic controls are optional.



自動切線系列新設計氣/電動上下切刀組，出刀迅速穩定精準，切線俐落，輕順低噪音調整容易

Auto trimmer with newly designed pneumatic / electric trimming system, trims precisely and stably, reduce sound and easy to adjust.



全新設計之內藏式定位器，定位精準，徹底解決外置式定位器，不易安裝，調整及定位不穩之情形

Newly designed built-in synchronizer, makes position precisely and stably, easy to adjust.



圓形粗細針縫目調整鈕的設計，隨心所欲精確調整縫目長短

Circular stitch length adjustment button, easily to adjust stitch length.



小型投射LED照明，穿線或調整機針作業方便（選配）

LED light, convenient for threading or adjusting the needle (Optional).

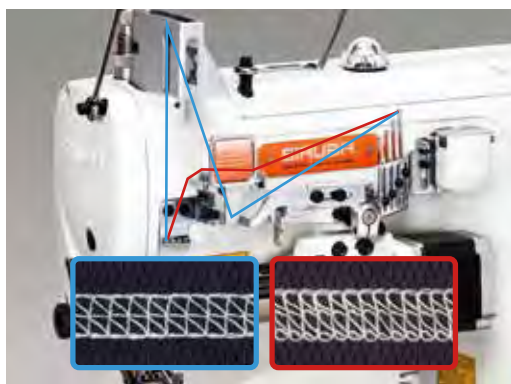

雙天秤挑線控線組





全新雙天秤挑線控線組的設計，縫製厚、薄布料皆適用，車縫適用範圍更廣，適用性更高

Dual Thread Take-up Mechanism

The brand new design of dual thread take-up lever thread tension combination is ideal for both heavy and light fabric. Sewing applicable range is wider and the applicability is higher.

- 中厚布料 (Medium heavy fabric)
- 薄布料 (Light fabric)

S1

								
S007K-W122-240/PCH-3M	2	4	4.0	1.4 ~ 4.2	0.8 ~ 1.4	5/7	UYX128GAS#10	4000
S007K-W122-248/PCH-3M	2	4	4.8	1.4 ~ 4.2	0.8 ~ 1.4	5/7	UYX128GAS#10	4000
S007K-W122-356/PCH-3M	3	5	5.6	1.4 ~ 4.2	0.8 ~ 1.4	5/7	UYX128GAS#10	4000
S007K-W122-364/PCH-3M	3	5	6.4	1.4 ~ 4.2	0.8 ~ 1.4	5/7	UYX128GAS#10	4000
S007KD-W122-240/PCH-3M/DS□	2	4	4.0	1.4 ~ 4.2	0.8 ~ 1.4	5/7	UYX128GAS#10	4000
S007KD-W122-248/PCH-3M/DS□	2	4	4.8	1.4 ~ 4.2	0.8 ~ 1.4	5/7	UYX128GAS#10	4000
S007KD-W122-356/PCH-3M/DS□	3	5	5.6	1.4 ~ 4.2	0.8 ~ 1.4	5/7	UYX128GAS#10	4000
S007KD-W122-364/PCH-3M/DS□	3	5	6.4	1.4 ~ 4.2	0.8 ~ 1.4	5/7	UYX128GAS#10	4000



S007K-W122-356/PCH-3M/UTT

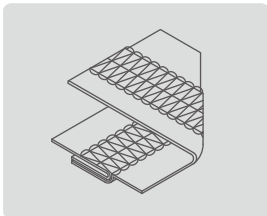

[三合一] 一般平縫 / 下擺車縫 / 拷克倒骨蓋

本機型為雙面飾中厚布用環縫橫式小筒車之基本機型，配附拷克倒骨進行多種功能車縫

例如：內衣褲、運動衫接縫、下擺車縫及倒骨縫

註：可依需求選擇出廠時之校縫

Eg: S007K-W122-356/PCH-3M 以下擺車縫校縫

S007K-W122-356/PCC-3M 以三線拷克倒骨中厚布校縫

S007K-W122-356/PCD-3M 以三線拷克倒骨薄布校縫

[3 IN 1] GENERAL SEAMING / BOTTOM HEMMING / COVERING (Fold-down Type)

This basic model of small cylinder machine. 3-in-1 model, includes bottom hemming/seam covering/overturned seam covering.

Remark : Initial setting can be set according to request :

Eg : S007K-W122-356/PCH-3M Hemming







S007K-W122-356/PCC-3M fold-down seam covering
for medium fabric

S007K-W122-356/PCD-3M fold-down seam covering
for light fabric

選購配件 OPTIONAL DEVICE

UTT , UTU , UTX , UTY , CMR , SAR/UTT , SAR/UTU

S2

								
S007K-W322-240/PCE	2	4	4.0	1.4 ~ 4.2	0.8 ~ 1.4	5/7	UYX128GAS#10	4000
S007K-W322-248/PCE	2	4	4.8	1.4 ~ 4.2	0.8 ~ 1.4	5/7	UYX128GAS#10	4000
S007K-W322-356/PCE	3	5	5.6	1.4 ~ 4.2	0.8 ~ 1.4	5/7	UYX128GAS#10	4000
S007K-W322-364/PCE	3	5	6.4	1.4 ~ 4.2	0.8 ~ 1.4	5/7	UYX128GAS#10	4000
S007KD-W322-240/PCE/DS□	2	4	4.0	1.4 ~ 4.2	0.8 ~ 1.4	5/7	UYX128GAS#10	4000
S007KD-W322-248/PCE/DS□	2	4	4.8	1.4 ~ 4.2	0.8 ~ 1.4	5/7	UYX128GAS#10	4000
S007KD-W322-356/PCE/DS□	3	5	5.6	1.4 ~ 4.2	0.8 ~ 1.4	5/7	UYX128GAS#10	4000
S007KD-W322-364/PCE/DS□	3	5	6.4	1.4 ~ 4.2	0.8 ~ 1.4	5/7	UYX128GAS#10	4000



拷克立骨蓋縫

適宜中厚布料，經三線拷克車縫後再包縫，用於運動服、汗衫等領口、下擺、袖管等之拷邊車縫後加以包縫，可增加服飾之美觀及車縫之牢固，利用導布片及壓具上之壓刀導縫，可避免車縫時彎曲不直

OVERLOCK-SEAM COVERING (Flating Type)

Bulging seam covering for medium fabric after 3 thread plain seaming, suitable for neck openings, sleeve, cuff or bottom of sportswears, T-shirts, etc... With fabric guide and special presser foot, making sewing easy and more efficient.

S007K-W322-356/PCE/UTT

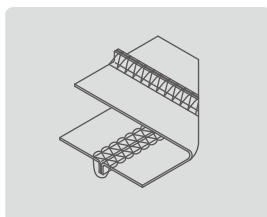
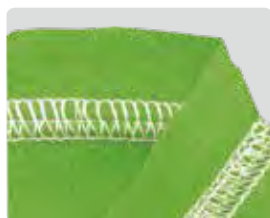

選購配件 OPTIONAL DEVICE
UTT , UTU , UTX , UTY , SAR/UTT , SAR/UTU , CMR



Model	2	4	4.0/4.8	1.4 ~ 4.2	0.8 ~ 1.4	1~5.5	5	Needle No.	S.P.M. (Max)
S007KD-W121-□□□/FFT/DS□	2	4	4.0/4.8	1.4 ~ 4.2	0.8 ~ 1.4	1~5.5	5	UYX128GAS#10	4000
	3	5	5.6/6.4	1.4 ~ 4.2	0.8 ~ 1.4	1~5.5	5	UYX128GAS#10	4000
S007KD-W122-□□□/FFT/DS□	2	4	4.0/4.8	1.4 ~ 4.2	0.8 ~ 1.4	1~5.5	5	UYX128GAS#10	4000
	3	5	5.6/6.4	1.4 ~ 4.2	0.8 ~ 1.4	1~5.5	5	UYX128GAS#10	4000
S007KD-W131-□□□/FFT/DS□	2	4	4.0/4.8	1.4 ~ 4.2	0.8 ~ 1.4	1~5.5	5	UYX128GAS#10	4000
	3	5	5.6/6.4	1.4 ~ 4.2	0.8 ~ 1.4	1~5.5	5	UYX128GAS#10	4000
S007KD-W132-□□□/FFT/DS□	2	4	4.0/4.8	1.4 ~ 4.2	0.8 ~ 1.4	1~5.5	5	UYX128GAS#10	4000
	3	5	5.6/6.4	1.4 ~ 4.2	0.8 ~ 1.4	1~5.5	5	UYX128GAS#10	4000



FFT 上送布功能

專利優化前後移動送具之結構設計，有效送布行程大，車縫送布更穩定

FFT TOP FEEDING FUNCTION

Back and forth moving feed dog is designed by patent and improved mechanism. The effective feeding stroke is bigger, and fabric feeding is more stable.

選購配件	OPTIONAL DEVICE
UTT, UTX	

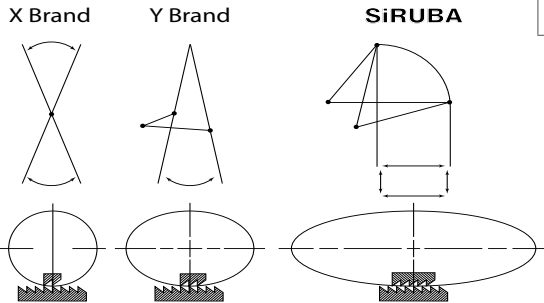

S4

S007KD-U173-100/SAR/RF/UTT/DS□	1	2	-	1.4 ~ 4.2	0.8 ~ 1.4	5/7	UYX128GAS#18	4000
--------------------------------	---	---	---	-----------	-----------	-----	--------------	------



S007KD-U173-100/SAR/RF/UTT/DS□

單針鏈縫牛仔褲轆腳機

針對彈性牛仔布料的車縫所開發的規格，配備專用的氣動式轆腳喇叭，因為具有差動送布功能，可以車縫出美觀平整的效果

- 標配：氣動式自動切線
 氣動抬壓腳
 直驅伺服馬達
 結束密縫

SINGLE NEEDLE CHAINSTITCH JEANS BOTTOM HEMMING MACHINE

Special gauge for elastic denim fabric, and equipped with pneumatic hemming folder. Because of the function of differential feeding, the sewing quality is nice and perfectly flat.

- Standard Equipment: Pneumatic thread trimmer
 Pneumatic presser foot lifter
 Direct-drive servo motor
 Condensed stitching device



S5

S007KD-W815A-356/SRL/UTT/DSK□	3	5	5.6	1.4 ~ 4.2	0.8 ~ 1.4	5/7	UYX128GAS#10	4000
-------------------------------	---	---	-----	-----------	-----------	-----	--------------	------



S007KD-W815A-356/SRL/UTT/DSKH1

左切刀修布下擺車縫

左切刀修布邊/下擺車縫工程適用於小筒型繡縫車

BOTTOM HEMMING WITH LEFT SIDE FABRIC TRIMMER

Left edge trimmer designed for small cylinder machine with auto thread trimmer function.



F007K/KD SERIES FEATURES

全新人體工學，圓弧流線時尚的外型設計，使用方便順手，賞心悅目
Brand new design of fashionable and smooth appearance, easy to sew.



上夾線裝置

出刀迅速精準，夾線穩定

Upper Thread Holder

Newly designed auto trimmer trims precisely and stably.

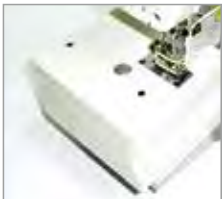

內縮式床台

縫製物更靠近機針，車縫定位精準，車縫時更加順暢就手

The Recessed Machine Bed

The sewing material is closer to the needle and the sewing is precise, which makes sewing operation easier and smoother.



拷克骨車縫附調整式進布誘導器，活動式壓腳，車縫適用性更廣

Cover seaming with adjustable folder, flexible presser foot, accommodate wider range of sewing items.



自動切線系列新設計氣/電動上下切刀組

出刀迅速穩定精準，切線俐落，輕順低噪音調整容易

Auto trimmer with newly designed pneumatic / electric trimming system trims precisely and stably, lower sound and easy to adjust.

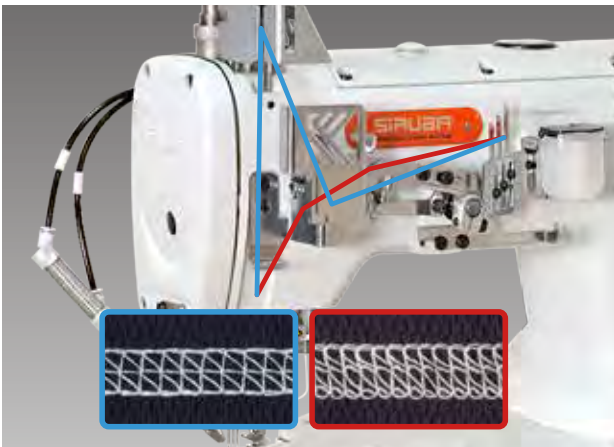

雙天秤挑線控線組

全新雙天秤挑線控線組的設計，縫製厚、薄布料皆適用，車縫適用範圍更廣，適用性更高

Dual Thread Take-up Mechanism

The brand new design of dual thread take-up lever thread tension combination is ideal for both heavy and light fabric. Sewing applicable range is wider and the applicability is higher.

— 中厚布料 (Medium heavy fabric)

— 薄布料 (Light fabric)

F1

								
F007K-W121-□□□/ FHA	2	4	4.0/ 4.8	1.6 ~ 4.2	0.5 ~ 1.3	5	UYX128GAS#10	6000
	3	5	5.6/ 6.4	1.6 ~ 4.2	0.5 ~ 1.3	5	UYX128GAS#10	6000
F007K-W122-□□□/ FHA	2	4	4.0/ 4.8	1.6 ~ 4.2	0.5 ~ 1.3	5	UYX128GAS#10	6000
	3	5	5.6/ 6.4	1.6 ~ 4.2	0.5 ~ 1.3	5	UYX128GAS#10	6000
F007K-W123-□□□/ FHA	2	4	4.0/ 4.8	1.6 ~ 4.2	0.5 ~ 1.3	5/7	UYX128GAS#10	6000
	3	5	5.6/ 6.4	1.6 ~ 4.2	0.5 ~ 1.3	5/7	UYX128GAS#10	6000
F007K-W162-□□□/ FHA	3	5	5.6/ 6.4	1.6 ~ 4.2	0.5 ~ 1.3	5/7	TVX5#14~16	6000
F007K-W162H-□□□/ FHA	3	5	5.6/ 6.4	6	0.5 ~ 1.3	5/7	TVX5#14~16	6000
F007KD-W121-□□□/ FHA/DF□	2	4	4.0/ 4.8	1.6 ~ 4.2	0.5 ~ 1.3	5	UYX128GAS#10	6000
	3	5	5.6/ 6.4	1.6 ~ 4.2	0.5 ~ 1.3	5	UYX128GAS#10	6000
F007KD-W122-□□□/ FHA/DF□	2	4	4.0/ 4.8	1.6 ~ 4.2	0.5 ~ 1.3	5	UYX128GAS#10	6000
	3	5	5.6/ 6.4	1.6 ~ 4.2	0.5 ~ 1.3	5	UYX128GAS#10	6000
F007KD-W123-□□□/ FHA/DF□	2	4	4.0/ 4.8	1.6 ~ 4.2	0.5 ~ 1.3	5/7	UYX128GAS#10	6000
	3	5	5.6/ 6.4	1.6 ~ 4.2	0.5 ~ 1.3	5/7	UYX128GAS#10	6000
F007KD-W162-□□□/ FHA/DF□	3	5	5.6/ 6.4	1.6 ~ 4.2	0.5 ~ 1.3	5/7	TVX5#14~16	6000
F007KD-W162H-□□□/ FHA/DF□	3	5	5.6/ 6.4	6	0.5 ~ 1.3	5/7	TVX5#14~16	6000



F007K-W121-356/FHA

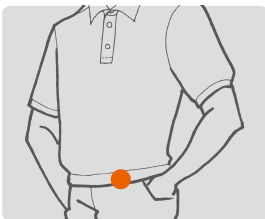

一般平縫 / 下擺車縫

本機型為雙面飾繃縫筒車之基本機型，可裝配附件進行多種功能車縫
例如：內衣褲、運動衫接縫及下擺車縫(附可調式下擺車縫組)

GENERAL SEAMING / BOTTOM HEMMING

Basic model of interlock stitch machine with double side cover-stitching. It is available for various sewing by optional devices. Such as plain seaming and bottom hemming for underwears, sportswears, etc... (equipped with adjustable hemming set)

- W121 : 薄布料 Light material
- W122 : 中厚布料 Medium material
- W123 : 厚布料 Heavy material
- W162 : 高行程 High needle bar stroke
- W162H : 高行程 High needle bar stroke
大針距(6mm) Long stitch length (6mm)

選購配件 OPTIONAL DEVICE

UTG, UTH, UTJ, UTK, FL

F2



F007K(D)-W222-□□□/ FQ(DF□)	2	4	4.0/ 4.8	1.6 ~ 4.2	0.5 ~ 1.3	5	UYX128GAS#10	6000
	3	5	5.6/ 6.4	1.6 ~ 4.2	0.5 ~ 1.3	5	UYX128GAS#10	6000
F007K(D)-W222-□□□/ FFD(DF□)	2	4	4.0/ 4.8	1.6 ~ 4.2	0.5 ~ 1.3	5	UYX128GAS#10	6000
	3	5	5.6/ 6.4	1.6 ~ 4.2	0.5 ~ 1.3	5	UYX128GAS#10	6000
F007K(D)-W222-□□□/ FFP(DF□)	2	4	4.0/ 4.8	1.6 ~ 4.2	0.5 ~ 1.3	5	UYX128GAS#10	6000
	3	5	5.6/ 6.4	1.6 ~ 4.2	0.5 ~ 1.3	5	UYX128GAS#10	6000



F007K-W222-356/FQ/FEC



F007K-W222-356/FFD



F007K-W222-356/FFP



FQ

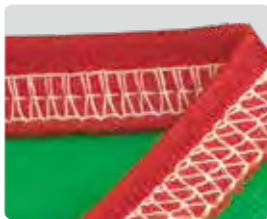

FQ

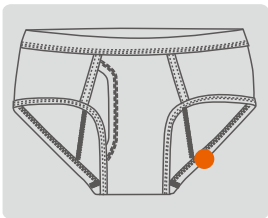

FFD/FFP



FFD/FFP

FQ:上帶滾邊車縫

適用於T恤、內衣褲之領口、褲管口等上帶滾邊之車縫工程。可加附電動(FEC)或氣動式(FAC)長切刀式切布條裝置。能將滾邊布條切斷。節省布條之用料增加車縫效率

FQ:TAPE BINDING

For tape binding on openings of leg or neck of underwears, T-shirts, etc... Also can attach electric(FEC) or pneumatic(FAC) tape cutter to save tape and increase sewing efficiency.

FFD / FFP:上帶滾邊車縫包覆鬆緊帶

上送帶裝置控制鬆緊帶張力。加上膝動控制鬆緊帶之左右移動。能有效讓鬆緊帶前後段與衣身車縫固定。適用於內褲之褲頭、褲腳之滾邊加鬆緊帶之車縫工程

FFD: 齒輪箱型精準張力控制

FFP: 彈簧片型簡易張力控制

FFD / FFP:TAPE BINDING WITH ELASTIC BAND

Top feeding device controls the elastic band's tension. Elastic band right-left position controller (by knee-pushing) sets the materials joining at the beginning and ending of waistband, leg opening of briefs...etc.

FFD: Gearbox type for accurate tension control

FFP: Spring type for simple tension control



◀ 以上機型可加裝
FNC, FSC:
電眼型後切刀附直驅馬達

Optional device for the above models

FNC, FSC:
Sensor type rear cutter with direct-drive servo motor

選購配件 OPTIONAL DEVICE

FA, LF-A, FAC, FEC, LS-A

F3



F007K-W222-240-4/FSM	3	8	4.0	1.6 ~ 4.2	0.5 ~ 1.3	5	UYX128GAS#10	2500
F007K-W222-248-4/FSM	3	8	4.8	1.6 ~ 4.2	0.5 ~ 1.3	5	UYX128GAS#10	2500
F007K-W222-364-4/FSM	4	9	6.4	1.6 ~ 4.2	0.5 ~ 1.3	5	UYX128GAS#10	2500



F007K-W222-356/FSM

花飾滾邊車縫

用於T恤衫、襯衫等領口、下擺、袖口等花飾滾邊車縫。附有四組花飾凸輪可變化成數百種車縫花樣。

ORNAMENTAL TAPE BINDING







Suitable for ornamental tape binding of neck band, bottom or cuff of T-shirts, shirts, etc...

選購配件 OPTIONAL DEVICE
FA



A	E	A	E	A	E	A	E
B	F	B	F	B	F	B	F
C	G	C		C	G	C	
D	H	D		D	H	D	

F4

								
F007K-W322-□□□/FDC	3	5	5.6/ 6.4	1.6 ~ 4.2	0.5 ~ 1.3	5	UYX128GAS#10	6000
F007KD-W322-□□□/FDC/DF□	3	5	5.6/ 6.4	1.6 ~ 4.2	0.5 ~ 1.3	5	UYX128GAS#10	6000
F007K-W322-□□□/FDE	3	5	5.6/ 6.4	1.6 ~ 4.2	0.5 ~ 1.3	5	UYX128GAS#10	6000
F007KD-W322-□□□/FDE/DF□	3	5	5.6/ 6.4	1.6 ~ 4.2	0.5 ~ 1.3	5	UYX128GAS#10	6000



F007K-W222-356/FDC



F007KD-W322-356/FDE/UTJ/DF□

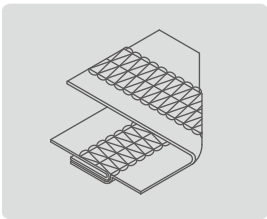

FDC



FDC

拷克倒骨蓋縫

FDC 倒骨型：適用於4線包縫之蓋縫

FDE 立骨型：適用於3線包縫之蓋縫

配件盒另附有FDC倒骨規格之牛角(導布片)

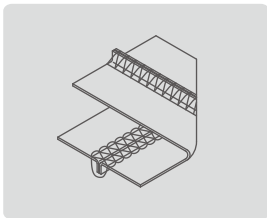

FDE

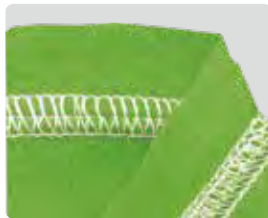

FDE

OVERLOCK-SEAM COVERING STITCH

FDC Fold-down type : For 4-thread overlock-seam covering stitch.

FDE Flattening type : For 3-thread overlock-seam covering stitch, and an extra guide of overlock-seam (FDC specification, fold-down type) is included in the accessory box.

選購配件 OPTIONAL DEVICE
UTG , UTH , UTJ , UTK

F5



F007K-W512-□□□/FE	2	4	4.0/ 4.8	1.6 ~ 4.2	0.5 ~ 1.3	5	UYX128GAS#10	4500
	3	5	5.6/ 6.4	1.6 ~ 4.2	0.5 ~ 1.3	5	UYX128GAS#10	4500
F007K-W512-□□□/FFC	2	4	4.0/ 4.8	1.6 ~ 4.2	0.5 ~ 1.3	5	UYX128GAS#10	4500
	3	5	5.6/ 6.4	1.6 ~ 4.2	0.5 ~ 1.3	5	UYX128GAS#10	4500
F007K-W512-□□□/SMK	2	4	4.0/ 4.8	1.6 ~ 4.2	0.5 ~ 1.3	5	UYX128GAS#10	4500
	3	5	5.6/ 6.4	1.6 ~ 4.2	0.5 ~ 1.3	5	UYX128GAS#10	4500
F007K-W512-□□□/STC	2	4	4.0/ 4.8	1.6 ~ 4.2	0.5 ~ 1.3	5	UYX128GAS#10	4500
	3	5	5.6/ 6.4	1.6 ~ 4.2	0.5 ~ 1.3	5	UYX128GAS#10	4500



F007K-W512-356/FE



F007K-W512-356/FFC

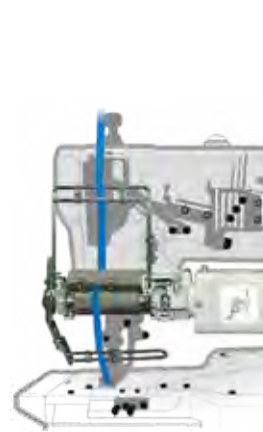

SMK



STC

鬆緊帶 / 蕾絲鬆緊帶上帶車

經由上送帶裝置 · 控制長度與張力,提高車縫品質 · 如女用內衣褲之鬆緊帶或蕾絲鬆緊帶車縫

FFC: 機械式送帶

FE: 簡易電子式送帶

SMK: 電子計數式送帶

SMK1-C-01 附定位器 · 適合簡易伺服或離合器馬達

SMK1-C-02 以中繼線 · 連接伺服馬達

STC: 張力控制式送帶

STC1-U-01 附定位器 · 適合簡易伺服或離合器馬達

STC1-U-02 以中繼線 · 連接伺服馬達

ELASTIC / LACE ATTACHING

Top feeding devices ensure even length and tension controlled by electric digital controller, for elastic or lace attaching smoothly and properly on women's underwears.

FFC: Mechanic type tape feeding.

FE: Simple electric type tape feeding.

SMK: Electric metering type tape feeding

SMK1-C-01 with synchronizer for simple servo motor or clutch motor

SMK1-C-02 Connected to servo motor by encoder cable

STC: Tension sensor type tape feeding

STC1-U-01 with synchronizer for simple servo motor or clutch motor

STC1-U-02 Connected to servo motor by encoder cable

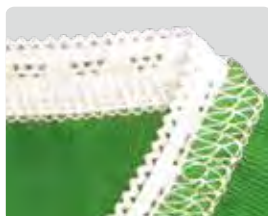
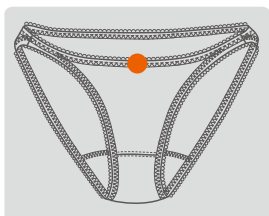

選購配件 OPTIONAL DEVICE

FAC, FEC, LF-A, LS-A

F6



F007K-W522-□□□/FR/FFC	2	4	4.0/ 4.8	1.6 ~ 4.2	0.5 ~ 1.3	5	UYX128GAS#10	4500
	3	5	5.6/ 6.4	1.6 ~ 4.2	0.5 ~ 1.3	5	UYX128GAS#10	4500
F007K-W522-□□□/FR/FE	2	4	4.0/ 4.8	1.6 ~ 4.2	0.5 ~ 1.3	5	UYX128GAS#10	4500
	3	5	5.6/ 6.4	1.6 ~ 4.2	0.5 ~ 1.3	5	UYX128GAS#10	4500
F007K-W522-□□□/FR/SMK	2	4	4.0/ 4.8	1.6 ~ 4.2	0.5 ~ 1.3	5	UYX128GAS#10	4500
	3	5	5.6/ 6.4	1.6 ~ 4.2	0.5 ~ 1.3	5	UYX128GAS#10	4500
F007K-W522-□□□/FR/STC	2	4	4.0/ 4.8	1.6 ~ 4.2	0.5 ~ 1.3	5	UYX128GAS#10	4500
	3	5	5.6/ 6.4	1.6 ~ 4.2	0.5 ~ 1.3	5	UYX128GAS#10	4500



F007K-W522-240/FR/FE/FAC

鬆緊帶 / 蕾絲鬆緊帶上帶車縫附右切刀

由上送帶裝置，控制長度與張力，附右切刀修布裝置，能於車縫前將布修齊，更能提高車縫品質，如女用內衣褲之鬆緊帶或蕾絲鬆緊帶車縫

FFC: 機械式送帶

FE: 簡易電子式送帶

SMK: SMK1-C-01 附定位器，適合簡易伺服或離合器馬達
SMK1-C-02 以中繼線，連接伺服馬達張力控制式送帶

STC: 張力控制式送帶

STC1-U-01 附定位器，適合簡易伺服或離合器馬達

STC1-U-02 以中繼線，連接伺服馬達張力控制式送帶

ELASTIC / LACE ATTACHING WITH RIGHT FABRIC TRIMMER

Top feeding devices ensure even length and tension controlled by electric digital controller, with right side fabric trimmer for elastic or lace attaching smoothly and properly on women's underwears.

FFC: Mechanic type tape feeding.

FE: Simple electric type tape feeding.

SMK: Electric metering type tape feeding

SMK1-C-01 with synchronizer for simple servo motor or clutch motor

SMK1-C-02 Connected to servo motor by encoder cable

STC: Tension sensor type tape feeding

STC1-U-01 with synchronizer for simple servo motor or clutch motor

STC1-U-02 Connected to servo motor by encoder cable

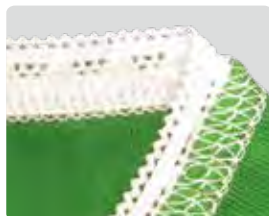
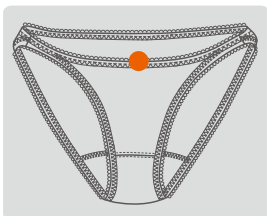

SMK



STC

選購配件 OPTIONAL DEVICE

FAC, FEC, LF-A, LS-A



F007K-W522-2□□/FR/FQS

2

4

3.2/ 4.0

1.6 ~ 4.2

0.5 ~ 1.3

5

UYX128GAS#10

4500



F007K-W522-240/FR/FQS

細滾邊車縫 (右切刀機型附側送小喇)

本機型適用於女性內褲或丁字褲之細滾邊車縫，在滾邊之前先經右切刀修布，避免發生爆縫問題，可搭配以下送帶裝置

SMK: 電子計數式送帶

SMK1-E-01 附定位器 · 適合簡易伺服或離合器馬達

SMK1-E-02 以中繼線 · 連接伺服馬達張力控制式送帶

STC: 張力控制式送帶

STC1-S-01 附定位器 · 適合簡易伺服或離合器馬達

STC1-S-02 以中繼線 · 連接伺服馬達



FINE TAPE BINDING (RIGHT TRIMMER MODEL WITH SMALL BINDER)

This machine is applicable for fine tape binding of women's underwear or T-string. Before tape binding, the fabric edge is trimmed by the right trimmer. This solves the problem of bad binding, which the tape is not sewn on the fabric. The below tape feeding devices are applicable.

SMK: Electric metering type tape feeding

SMK1-E-01 with synchronizer for simple servo motor or clutch motor

SMK1-E-02 Connected to servo motor by encoder cable

STC: Tension sensor type tape feeding

STC1-S-01 with synchronizer for simple servo motor or clutch motor

STC1-S-02 Connected to servo motor by encoder cable

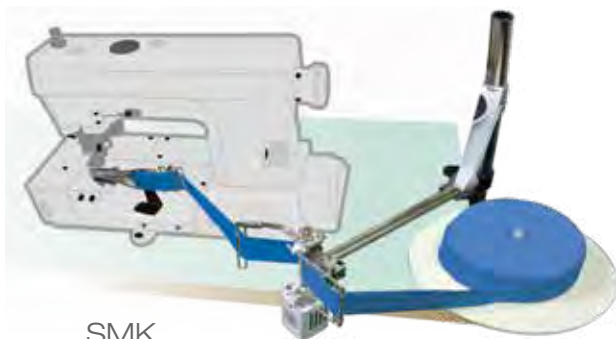

SMK



STC

選購配件 OPTIONAL DEVICE

FAC, FEC, LF-A, LS-A, TUA



F8



F007K-U122-232/FP	2	3	3.2	1.6 ~ 4.2	0.5 ~ 1.3	7	TVX5#14	6000
F007KD-U122-232/FP/DF□	2	3	3.2	1.6~4.2	0.5 ~ 1.3	7	TVX5#14	6000



F007K-U122-232/FP

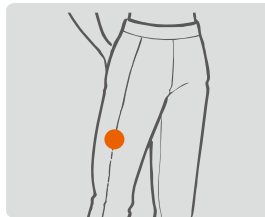

折線條車縫

本機種適用於運動服、牛仔或其他服飾之凸面折線條車縫，車縫時可於折線條內另加縫線繩，以增加凸線條之立體感和裝飾效果

PINTUCK SEAMING

To sew a decorative convex stripe on sportswears, jeans or other clothes, can also add extra stripe inside convex to increase the effects of convexity and decoration.

F9



F007K-U613-256/FBP	2	3	5.6	1.6 ~ 4.2	0.5 ~ 1.3	7	TVX5 #14 ~ #18	6000
F007K-U613-264/FBP	2	3	6.4	1.6 ~ 4.2	0.5 ~ 1.3	7	TVX5 #14 ~ #18	6000
F007KD-U613-256/FBP/DF□	2	3	5.6	1.6 ~ 4.2	0.5 ~ 1.3	7	TVX5 #14 ~ #18	6000
F007KD-U613-264/FBP/DF□	2	3	6.4	1.6 ~ 4.2	0.5 ~ 1.3	7	TVX5 #14 ~ #18	6000



F007K-U613-256/FBP

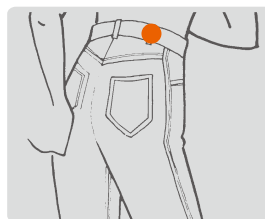

褲耳車縫

利用已裁好之等寬布條連續快速製作褲耳

BELT-LOOP SEAMING

Mass production for belt loop by using stripped tape.

選購配件 OPTIONAL DEVICE

LF-A, LS-A

F10

								
F007K-U712(A)-264/FSP	2	4	6.4	1.6 ~ 4.2	0.5 ~ 1.3	5	DVX43#11 ~ #16	6000
F007KD-U712(A)-264/FSP/DF□	2	4	6.4	1.6 ~ 4.2	0.5 ~ 1.3	5	DVX43 #11 ~ #16	6000
F007K-U712-496/FSS	4	6	3.2	1.6 ~ 4.2	0.5 ~ 1.3	5	UYX128GAS#10	6000
F007K-U712-4111/FSS	4	6	3.7	1.6 ~ 4.2	0.5 ~ 1.3	5	UYX128GAS#10	6000
F007KD-U712-496/FSS/DF□	4	6	3.2	1.6 ~ 4.2	0.5 ~ 1.3	5	UYX128GAS#10	6000
F007KD-U712-4111/FSS/DF□	4	6	3.7	1.6 ~ 4.2	0.5 ~ 1.3	5	UYX128GAS#10	6000



F007K-U712-264/FSP



F007K-U712-496/FSS

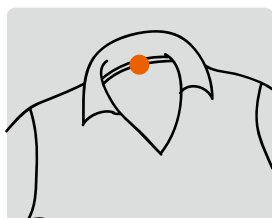

FSP



FSP

布條車縫 (雙針雙勾)

本機系將拷克後之拷克骨縫上布條以補強及增加美觀之用，如男內褲、休閒褲等之車縫

U712: 成品寬度10mm

U712A: 成品寬度12mm

TAPE ATTACHING (TWO NEEDLE , TWO LOOPER)

This machine is specially for tape binding on cross seaming of men's briefs or sportswears to strengthen plain seam and for ornamental purpose.

U712: finished tape width 10mm

U712A: finished tape width 12mm

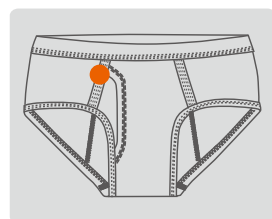

FSP/FSS

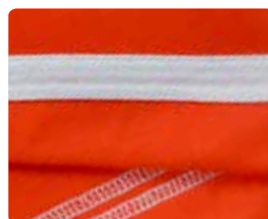

FSS

布條車縫 (四針雙勾)

本機系將拷克後之拷克骨縫上布條以補強及增加美觀之用，如男內褲、休閒褲等之車縫

TAPE ATTACHING (FOUR NEEDLE , TWO LOOPER)

This machine is specially for tape binding on cross seaming of men's briefs or sportswears to strengthen plain seam and for ornamental purpose.

選購配件 OPTIONAL DEVICE

LF-A , LS-A

F11



F007K-U712-264/FSR	2	4	6.4	1.6 ~ 4.2	0.5 ~ 1.3	5	TVX7 #12 ~ #14	6000
F007KD-U712-264/FSR/DF□	2	4	6.4	1.6 ~ 4.2	0.5 ~ 1.3	5	TVX7 #12 ~ #14	6000



F007K-U712-264/FSR

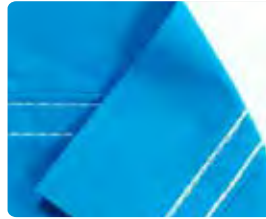
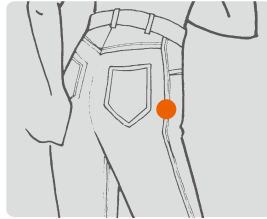

捲疊縫

本機種設計特殊之左右齒差動方式，能使捲疊縫縫紉更順暢車縫後左右二片布均一無長短之虞，適用於西褲、休閒褲、牛仔褲薄至厚布料等之捲邊疊縫

LAP SEAMING

Differential ratio of left and right feed dog can be adjusted separately for lap seaming to ensure symmetrical length to both left and right fabric. Applicable to trousers, casual pants and jeans, etc...

F12



F007K-W722-388/FY	3	7	8.8	1.6 ~ 4.2	0.5 ~ 1.3	5	TVX7 #12	6000
F007KD-W722-388/FY/DF□	3	7	8.8	1.6 ~ 4.2	0.5 ~ 1.3	5	TVX7 #12	6000



F007K-W722-388/FY

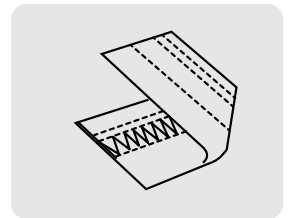
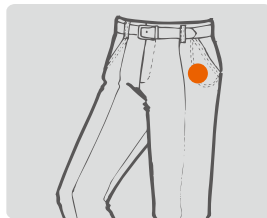

褲袋裡車縫

本機為三針三勾針一上叉，可同時縫合褲袋內裡與表布並強化車縫處之牢固，增加美觀提高效率，適用於西褲、工作褲等

POCKET LINING SEAMING

This is a 3 needles 3 loopers 1 spreader machine, and special for seaming the shell fabric and lining of pocket in trousers or work pants in simple operation to increase sewing quality and efficiency.

F13



F007K-W922-456/FW	4	6	5.6	1.6 ~ 4.2	0.5 ~ 1.3	5	SMX1014B#10	6000
F007K-W922-460/FW	4	6	6.0	1.6 ~ 4.2	0.5 ~ 1.3	5	SMX1014B#10	6000
F007K-W922-464/FW	4	6	6.4	1.6 ~ 4.2	0.5 ~ 1.3	5	SMX1014B#10	6000
F007KD-W922-456/FW/DF□	4	6	5.6	1.6 ~ 4.2	0.5 ~ 1.3	5	SMX1014B#10	6000
F007KD-W922-460/FW/DF□	4	6	6.0	1.6 ~ 4.2	0.5 ~ 1.3	5	SMX1014B#10	6000
F007KD-W922-464/FW/DF□	4	6	6.4	1.6 ~ 4.2	0.5 ~ 1.3	5	SMX1014B#10	6000



F007K-W922-456/FW

四針六線搭接縫車縫

適用於一般內衣褲二片布接縫處之接縫和補強，附有專屬之導邊，可使二片布順暢縫合

FOUR-NEEDLE FLAT SEAMING

For flat seaming 2 pieces of fabric. Equipped with fabric guide for easy operation.

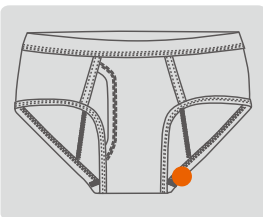
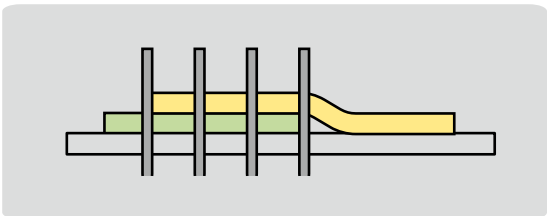

FW-4A

FW- 4	四針，無假針，適用上網線切線刀 4 needles Without retainer, applicable to upper thread trimmer
FW- 4A	配特殊針板 E1838P，適合車縫運動鞋裝飾線 With special needle plate E1838P, applicable to shoe decoration
FW- 5	四針，有假針，不適用上網線切線刀 4 needles with retainer, not applicable to upper thread trimmer

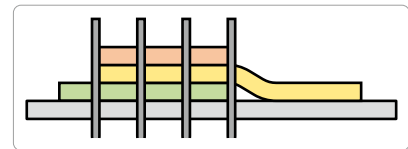

FWP

附喇叭 (B417R) 與導帶架

With folder (B417R) and tape guide.

選購配件 OPTIONAL DEVICE
UTH, UTK

F14



Model	2	4	4.0/ 4.8	1.6 ~ 4.2	0.5 ~ 1.3	1~5.5	5	UYX128GAS#10	4500
F007KD-W121-□□□/FFT/FHA/DF□	3	5	5.6/ 6.4	1.6 ~ 4.2	0.5 ~ 1.3	1~5.5	5	UYX128GAS#10	4500
F007KD-W122-□□□/FFT/FHA/DF□	3	5	5.6/ 6.4	1.6 ~ 4.2	0.5 ~ 1.3	1~5.5	5	UYX128GAS#10	4500
F007KD-W131-□□□/FFT/FHA/DF□	3	5	5.6/ 6.4	1.6 ~ 4.2	0.5 ~ 1.3	1~5.5	5	UYX128GAS#10	4500
F007KD-W132-□□□/FFT/FHA/DF□	3	5	5.6/ 6.4	1.6 ~ 4.2	0.5 ~ 1.3	1~5.5	5	UYX128GAS#10	4500



FFT 上送布功能

專利優化前後移動送具之結構設計，有效送布行程大，車縫送布更穩定

FFT TOP FEEDING FUNCTION

Back and forth moving feed dog is designed by patent and improved mechanism. The effective feeding stroke is bigger, and fabric feeding is more stable.

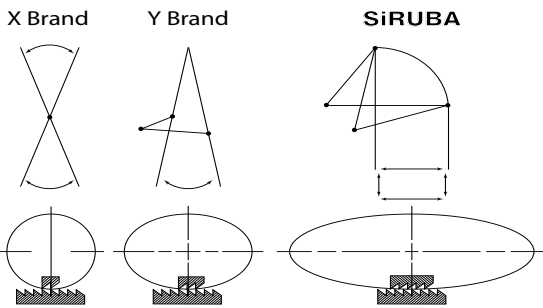

選購配件 OPTIONAL DEVICE
UTG , UTJ



F15

									
F007KD-U131-248/FFT/FHK/DF□	2	3	4.8	1.6 ~ 4.2	0.5 ~ 1.3	1~5.5	5	UYX128GAS#10	4500
F007KD-U131-256/FFT/FHK/DF□	2	3	5.6	1.6 ~ 4.2	0.5 ~ 1.3	1~5.5	5	UYX128GAS#10	4500
F007KD-U131-264/FFT/FHK/DF□	2	3	6.4	1.6 ~ 4.2	0.5 ~ 1.3	1~5.5	5	UYX128GAS#10	4500
F007KD-U132-248/FFT/FHK/DF□	2	3	4.8	1.6 ~ 4.2	0.5 ~ 1.3	1~5.5	5	UYX128GAS#10	4500
F007KD-U132-256/FFT/FHK/DF□	2	3	5.6	1.6 ~ 4.2	0.5 ~ 1.3	1~5.5	5	UYX128GAS#10	4500
F007KD-U132-264/FFT/FHK/DF□	2	3	6.4	1.6 ~ 4.2	0.5 ~ 1.3	1~5.5	5	UYX128GAS#10	4500



F007KD-U131-356/FFT/FHK/DF□

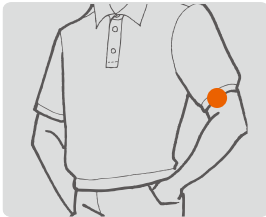

二針三線，袖口自動車縫裝置

1. T恤袖口、下擺氣動式自動送布、折布裝置，大幅節省人力及提升技術力
2. 可依客戶車縫需求自行調整下擺折邊寬度（附刻畫尺），及下折布料距左針之左右寬度調整，免裁切布料，節省材料成本
3. 電眼自動檢測送布、折邊、抬壓腳裝置，作業完成後自動停機
4. 最大產能約：6000件~7000件（袖口）/8小時

2 NEEDLE 3 THREAD AUTOMATIC SLEEVE HEMMING DEVICE

1. The pneumatic automatic feeding and folding device is for T-shirt sleeve hemming, which can save manpower and upgrade technique.
2. Customers can adjust the width of hemming folding edge and the horizontal width between folding fabric and left needle as required. Since there is no need to cut the fabric in advance material cost can be saved.
3. The electric eye can detect feeding, edging and presser foot lifter automatically. After finishing the action, the operation will stop automatically.
4. The maximum productivity: 6000 – 7000 pc (cuff)/ 8 hours.

DEVICE



CAR

氣動式密縫裝置 Pneumatic Condense Stitching Device (CAR/SAR)

膝動式密縫裝置 Manual Condense Stitching Device (CMR)

藉由縮短送具行程，在車縫起始或結束時進行密縫的功能，確保縫線不易脫落，提高車縫品質，基本車為腳踏板控制，電動和氣動控制為選配，本配件需更換專用規格組

By reducing the strokes of feed dog, at the beginning and the end of sewing, condense stitching reinforces the stitches. This enhances the sewing sturdiness and quality. Basic model is controlled by pedal. Electric and pneumatic controls are optional. Exclusive gauge sets is required.



SAR



CMR

Applicable Model	CAR (Pneumatic)	SAR (Pneumatic)	CMR (Manual)
C007K C007KD/DC□	√	X	√
S007K S007K/DS□	X	√	√

可自行組裝 self-installation : YES



CC

拷克倒骨蓋縫裝置 Overlock- Seam Covering (Fold-down Type)

- 適中厚至厚布料經四線拷克車包縫後之飾縫
 - 對於運動服，領子，衣襟，袖管之拷邊車縫後加以單面或雙面裝飾環縫，可增加服飾之美觀及車縫之牢固。利用導布片及壓具上之壓刀導縫，可避免車縫時彎曲不直
1. Overturned seam covering for medium to heavy fabric after 4 thread plain seaming.
2. Suitable for neck openings, sleeve, cuff or bottom of sportswears, T-shirts, etc... With fabric guide and special presser foot making sewing easy and more efficient.

可自行組裝 self-installation : YES

適用機型 applicable model : C007K/KD-W322, C007L-W325



CE

拷克倒 / 立骨蓋縫裝置 Overlock-Seam Covering (Fold-down / Flattening Type)

- 適中厚布料經三線拷克車包縫後之飾縫
- 對於運動服，領子，衣襟，袖管之拷邊車縫後加以單面或雙面裝飾環縫，可增加服飾之美觀及車縫之牢固。利用導布片及壓具上之壓刀導縫，可避免車縫彎曲不直

1. Bulging seam covering for medium fabric after 3 thread plain seaming.

2. Suitable for neck openings, sleeve, cuff or bottom of sportswears, T-shirts, etc... With fabric guide and special presser foot making sewing easy and more efficient.

可自行組裝 self-installation : YES

適用機型 applicable model : C007K/KD-W322, C007L-W325, C007L-U325



CFC

鬆緊帶折縫 Elastic Hemming

經由齒輪控制箱之控制，能有效控制鬆緊帶之鬆緊度，配合三折或二折折布喇叭及鬆緊帶壓縫，可精確完美的進行短褲、內褲等褲腳及褲頭之鬆緊帶折縫

Elastic hemming evenly length and elasticity is controlled by gear box. Great for seam covering with two or three plies hemming binder on elastic for waistband or leg opening of briefs and shorts's, etc...

可自行組裝 self-installation : NO

適用機型 applicable model : C007K-W542



CH

下擺車縫 Hemming

T恤、內衣及兒童服飾之下擺及袖口之車縫，可隨需要調整下擺飾縫組寬度，操作簡單快捷

Suitable for the bottom hemming of T-shirts, underwears, cuff of children's garments, etc... Able to adjust the width of hemming set to fit demands, easy operation.

可自行組裝 self-installation : YES

適用機型 applicable model : C007K/KD-W121, C007K/KD-W122, C007K/KD-W123, C007K/KD-W162, C007L-W125, C007L-W165, C007L-U125, C007JP-W125



CHK

下擺車縫 Hemming

T恤、內衣及兒童服飾之下擺及袖口之車縫，可隨需要調整下擺飾縫組寬度，操作簡單快捷

CHK-A1 用於一般機型

CHK-UT 用於自動切線機型

Suitable for bottom hemming of T-shirts, underwears, cuff of children's garments, etc...

Able to adjust the width of hemming set to fit demands, easy operation.

CHK-A1 is for normal type machine

CHK-UT is for auto trimmer type machine

可自行組裝 self-installation : YES

適用機型 applicable model : C007KD-U131



CHP

[二合一]氣動式下擺車縫 / 環型鬆緊帶折縫附左切刀修布邊功能

[2 IN 1]Pneumatic Hemming / Tubular Elastic Tape hemming With Left Edge Trimmer

氣動式布料導邊器能將布料及鬆緊帶順暢的捲折，此外左切刀切齊後再進行縫紉，可增加包縫工程之品質與效率，適用於男內褲、運動褲等褲頭鬆緊帶包縫

With pneumatic driving folder to fold fabric and insert elastic smoothly, left hand side fabric trimming before hemming increases sewing quality & efficiency. For hemming sleeve opening and bottom of underwears, T-shirts, or sportswears, etc...



CY

可自行組裝 self-installation : NO

適用機型 applicable model : C007K/KD-W822



CL

後拉引滾輪 Rear Puller

1. 可拉車縫過後之布及鬆緊帶，使其不會產生車縫過後擠壓之毛病，以達車縫平順快速之效果
2. 本輔助件同時內附齒狀滾輪CL (CL19+ CL53) 與平面滾輪CLA (CL20+CL52)，供客戶依車縫布料之不同來選擇使用。一般布料用平面滾輪，但另車縫鬆緊帶或蕾絲鬆緊帶時，請用齒狀滾輪
3. 為能正確之校縫，機器裝配時會按實際需要裝齒狀滾輪與平面滾輪，但於配件盒附上另一組齒輪



CLA

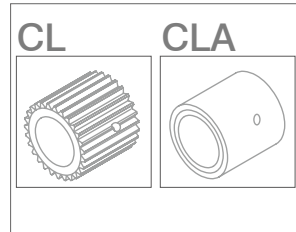

1. Pulls the fabric and elastic after sewing and makes sewing fast, flat and smooth without wrinkles.
2. The attachment includes both CL(CL19+CL53) and CLA(CL20+CL52). CLA is flat type for normal material, and CL is serrated type for elastic or lace, etc...
3. For fine-tuning purpose, the machine will be equipped with one rear puller depending on actual demand, the other one will be placed in the accessory box.

可自行組裝 self-installation : NO

適用機型 applicable model : C007K/KD



CQ

上帶滾邊車縫 Tape Binding

1. T 恤、內衣褲、兒童服飾等之領口、袖口和褲管口之包邊
2. 訂購內附CQ之機器內附FG組，但個別購買CQ裝置時則不另附FG組
3. 包邊喇叭之標準規格為入布寬度1-3/8"，出布時成三折，寬度為1/2"。若需訂購標準品以外之尺寸，請於訂購時特別註明，但交期及費用另計
4. 本輔助件有三種訂購方式：



CQA

1. For tape binding on openings of leg or neck of underwears, T-shirts, etc...
2. If purchased machine with CQ device, FG device will also be included. If only CQ device were purchased, no FG included.
3. Binder's standard tape size is 1-3/8" wide and finished size is 1/2" wide in 3 folds. Please remark if need another size when ordering, delivery and cost will be recalculated.
4. Ways to order the device:

機型 Model	CQ	FG	CQ 規格組 CQ Gauge Set	喇叭 Binder
C007KD-W222-240/CQ	√	√	√	√
C007KD-W222-240	X	X	√	X
C007KD-W222-240/CQ-P	√	√	√	X

可自行組裝 self-installation : YES

適用機型 applicable model : C007K/KD-W222



CR

右切刀修布及切布裝置 Right Hand Side Trimmer

修齊右邊或右下方多餘之布料，使衣物車縫後更加整齊美觀；附加吸布屑裝置更能保持工作環境乾淨

Right hand side waste fabric trimming with waste suction device makes fabric edge aligned to seam and keeps the working area clean.

可自行組裝 self-installation : NO

適用機型 applicable model : C007K-W522, C007K/KD-W532, C007L-W535, C007L-U535



CRL

左切刀修布裝置 Left Hand Side Trimmer

修齊二片布接縫之左下方多餘之布料，使衣物車縫後更加整齊美觀
Left hand side fabric trimming makes fabric edge aligned to seam.

可自行組裝 self-installation : NO

適用機型 applicable model : C007K/KD-W812(A), C007K/KD-W822, C007L-W815,
C007L-U815, C007L-W825, C007L-U815, C007JP-W815,
C007JP-U815, C007JP-W825, C007JP-U825



CSA

鐵桶式吸風馬達 Iron Case Suction

1. 雙吸馬力足 (前後吸) · 裝在車頭上比同類馬達大1 / 4的馬力
(後吸為切刀 · 前為漏斗式吹氣)
2. 噪音低 · 可比同類馬達降低5分貝
3. 溫度低 · 可比同類馬達降溫18%
4. 節省空間 · 裝在車板下比同類馬達節省10%的體積
5. 容易安裝 · 可比同類馬達少1 / 2安裝時間
6. 清理順暢 · 拆裝容易 · 集塵無漏洞
7. 風壓可視需求調整大小

1. Two-way suction (rear and front suction). 1/4 horsepower more than normal standard. (rear suction is for thread trimmer, front suction is for fabric waste)
2. Quiet. 5dB lower than normal standard.
3. Low temperature. 18% in celsius lower than normal standard.
4. Space efficiency. 10% space saved than normal standard.
5. Easy assembly. 50% time saved for assembly.
6. Easy to clean, easy to assemble/disassemble, completed dust collection.
7. Air pressure can be adjusted as needed.

可自行組裝 self-installation : YES

適用機型 applicable model : F007K/FR, C007K/CR, C007K/CRL



CSB

塑膠筒式吸風器 Plastic Tank Suction

1. 單吸馬力足 · 裝在車頭上比同類馬達大1 / 4的馬力 (適用後吸切刀)
2. 噪音低 · 可比同類馬達降低5分貝
3. 溫度低 · 可比同類馬達降溫10%
4. 節省空間 · 裝在車板下比同類馬達節省25%的體積
5. 容易安裝 · 可比同類馬達少1 / 4安裝時間
6. 清理順暢 · 拆裝容易 · 集塵無漏洞
7. 風壓可視需求調整大小

1. One-way suction, 1/4 horsepower more than other brands.
(for rear suction thread trimmer)
2. Quiet, 5dB lower than normal standard.
3. Low temperature. 10% lower than normal standard.
4. Space efficiency. 25% space saved than normal standard.
5. Easy assembly. 25% time saved for assembly.
6. Easy to clean, easy to assemble /disassemble, completed dust collection.
7. Air pressure can be adjusted as needed.

可自行組裝 self-installation : YES

適用機型 applicable model : F007K/FR, C007K/CR, C007K/CRL

**CW****四針六線環縫車縫裝置 Four-needle Flat Seaming**

適用於一般內衣褲二片布接縫處之接縫和補強，附有專屬之導邊器，可使二片布順暢縫合
For flat seaming 2 pieces of fabrics on men's briefs, fabric guide included.

可自行組裝 self-installation : YES
適用機型 applicable model : C007K/KD-W922

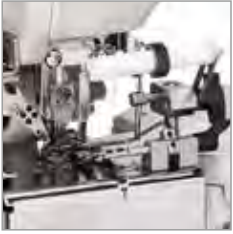
**CX****環型平織鬆緊帶包縫裝置 Pneumatic Elastic Inserting**

環型平織鬆緊帶或蕾絲鬆緊帶與衣物接縫，適用於男女內褲褲腰之鬆緊帶縫合，配合右切刀修布裝置更能提高縫製品質

For tubular elastic or lace waistband attaching on men's or women's briefs, with right hand side fabric trimming to increase sewing quality and efficiency.

可自行組裝 self-installation : YES
適用機型 applicable model : C007K/KD-W532,C007L-W535,C007L-U535

**CZ****氣動式環型羅紋鬆緊帶包縫裝置 Pneumatic Elastic Inserting**

男女用內褲之褲頭環型棉織鬆緊帶之包縫，本裝置需搭配CL及RLQ使用

Attaching tubular elastic tape onto waistband, suitable for briefs. For using this device, CL and RLQ must be equipped together.

可自行組裝 self-installation : YES
適用機型 applicable model : C007K/KD-W152

**CZP****膝動式環型羅紋鬆緊帶包縫裝置 Manual Elastic Inserting**

男女用內褲之褲頭環型棉織鬆緊帶之包縫，本裝置需搭配CL及RLQ使用

Attaching tubular elastic tape onto waistband, suitable for briefs. For using this device, CL and RLQ must be equipped together.

可自行組裝 self-installation : YES
適用機型 applicable model : C007K/KD-W152

**DCL 1 2****下軸型直驅伺服馬達 Lower main shaft type Direct-drive servo motor****DCK 1 2**

繡縫機模組化搭配直驅伺服馬達，多樣化的選擇，更有彈性

DFK 1 2

1 = 廠商代碼 + 版本代碼 2 = 版本代碼 + 功能代碼

DSK 1 2

Interlock machine equipped with the modularized direct-drive servo motors to be more flexible for diversification.

1 = Manufacturer code + version code 2 = Version code + Function code

可自行組裝 self-installation : YES
適用機型 applicable model : 全系列繡縫機 All Interlock Series



FA

側向電動送帶裝置 Side Electric Tape Feeding

1. 利用電子微動開關控制布條·鬆緊帶或蕾絲之輸送長度·使上帶車縫更加平順
 2. 送帶在控制箱右邊
1. With electronic switch to control the feeding length of tape, elastic, or lace to create smoother sewing.
 2. Tape feeding will be on the right hand side of the control box.

可自行組裝 self-installation : YES

適用機型 applicable model : C007K/CQ, C007K/CQA, C007KD/CQ, C007KD/CQA, F007K/FQ, F007K/FFD, F007K/FFP, F007K/FSM, F007KD/FQ, F007KD/FFP

F□C 後切刀系列 Rear Cutter Series



FAC



FEC



FNC/FSC



FNC



FSC

	操作模式 Operation Mode	切刀驅動 Cutter Driven by	電眼 Sensor	抬壓腳 Presser foot lifter	控制器 Controller	功能 Function
FAC	膝動 Knee	氣缸 + 機械閥 (氣動) Air cylinder + mechanical Valve (Pneumatic)	/	/	/	手動切刀 Manual Cutting
FEC	膝動 Knee	電磁鐵 (電動) Solenoid (Electric)	/	/	FE202-A 專用電控箱 Specific control box	手動切刀 Manual Cutting
FNC	自動/膝動 Auto/ Knee	氣缸 + 電磁閥 (氣動) Air cylinder + Solenoid (Pneumatic)	√	√	GD60-4-FK-220 伺服馬達驅動 Driven by servo motor	電眼偵測布邊 (類似700QD/ECA) The sensor checks the cloth edge. (Similar to 700QD/ECA)
FSC	自動/膝動 Auto/ Knee	氣缸 + 電磁閥 (氣動) Air cylinder + Solenoid (Pneumatic)	√	√	i70L-4-ME-220 伺服馬達驅動 附觸控面板 Driven by servo motor, with Control Panel	電眼偵測布邊·並且控制器以計數方式, 控制布帶的鬆緊度與餘留長度·適用比基尼車縫 Checking the cloth edge by sensor, and also the metering device controls the tape tension and the remained length. Applicable to bikini sewing.

可自行組裝 self-installation : NO

適用機型 applicable model : F007K/FQ, F007K/FE, F007K/SMK, F007K/STC, F007K/FR, F007K/FR/FQS,





FBP

褲耳車縫 Belt Loop Seaming

利用已裁好等寬之布條連續快速車縫褲耳

1. 一般W122機型可變換成FBP機型，只需訂購組件FBP- 256或FBP- 264，便可換成車褲耳之功能

2. 因所車縫布料不同而其所搭配之喇叭與針也會不同，訂購時請註明

Mass production for belt loop by using stripped tape.

1. Normal W122 type can be changed to FBP type with FBP-256 or FBP-264 for belt loop seaming.

2. Different size folders and needles may be required depends on different fabric. Please refer to the below table and remark when ordering.

針距 Needle Gauge	成品尺寸 Finished Good	喇叭代號 Folder No.	布料 Fabric
5.6mm	9 mm	FBP01A	男女西服 Suits for Men & Women
5.6mm	10mm	FBP01B	
6.4mm	12mm	FBP01C	牛仔 Jeans

可自行組裝 self-installation : YES

適用機型 applicable model : F007K-U613, F007KD-U613



FDC

拷克倒骨包縫裝置 Covering Seaming

1. 適中厚至厚布料經四線拷克車包縫後之飾縫

2. 對於運動服等衣物之領子、衣襟、袖管之拷邊包縫後加以單面或雙面裝飾環縫，可增加服飾之美觀及車縫之牢固。利用導布片及壓具壓刀之導縫，可避免車縫彎曲不直

1. Overturned seam covering for medium to heavy fabric after 4 thread plain seaming.

2. Suitable for neck openings, sleeve, cuff or bottom of sportswears, T-shirts, etc... With fabric guide and special presser foot making sewing easy and more efficient.

可自行組裝 self-installation : YES

適用機型 applicable model : F007K-W322, F007KD-W322



FDE

拷克立骨包縫裝置 Covering Seaming

1. 適中厚至厚布料經三線拷克車包縫後之飾縫

2. 對於運動服等衣物之領子、衣襟、袖管之拷邊包縫後加以單面或雙面裝飾環縫，可增加服飾之美觀及車縫之牢固。利用導布片及壓具壓刀之導縫，可避免車縫彎曲不直

1. Bulging seam covering for medium to heavy fabric after 3 thread plain seaming.

2. Suitable for neck openings, sleeve, cuff or bottom of sportswears, T-shirts, etc... With fabric guide and special presser foot making sewing easy and more efficient.

可自行組裝 self-installation : YES

適用機型 applicable model : F007K-W322, F007KD-W322



FE

電子式鬆緊帶控制裝置 Electric Type Elastic Feeding

1. 經由電子控制箱之數位設定，能有效控制鬆緊帶在設定好之鬆緊度輸送，以供車縫

2. 本裝置可接受鬆緊帶最大輸送寬度為2-1/2"

1. Elastic feeding ensures even length and elasticity, controlled by electronic digital control box.

2. Maximum feeding width of elastic is 2-1/2".

可自行組裝 self-installation : YES

適用機型 applicable model : F007K-W512, F007K-W522, C007K-W512, C007K-W522



FFC

機械式鬆緊帶控制裝置 Mechanic Type Elastic Feeding

1. 經由機體內機械帶動可自動輸送鬆緊帶，並經由齒輪箱控制器旋轉鈕，可依照衣服尺寸，微調設定車縫鬆緊帶之鬆緊程度
 2. 本裝置可接受鬆緊帶最大輸送寬度為2-1/2"
1. Elastic feeding ensures even length and elasticity controlled by gear set.
2. Maximum feeding width of elastic is 2-1/2".

可自行組裝 self-installation : No

適用機型 applicable model : F007K-W512, F007K-W522, C007K-W512, C007K-W522



FFD

腰間或褲腳包縫控制鬆緊帶前後車縫裝置(機械式) Mechanic Type Elastic Feeding & Binding

1. 短褲及男女用內褲褲頭或褲腳之鬆緊帶包縫，利用無段變速控制器，可精確調整鬆緊帶的鬆緊程度；運用操作簡便之膝動控制系統，控制鬆緊帶前後車縫，使車縫更完美
 2. 本裝置可接受鬆緊帶最大之尺寸為1 / 8" 到1 / 4" 之寬度
1. Elastic feeding ensures even length and elasticity controlled by gear set with elastic tape side-motion controller for sewing the beginning and ending of elastic tape onto waistband, leg opening of briefs, etc...
2. Maximum width of elastic is 1/8" to 1/4".

可自行組裝 self-installation : YES

適用機型 applicable model : F007K-W222



FFP

腰間或褲腳包縫控制鬆緊帶前後車縫裝置(彈簧式) Mechanic Type Elastic Feeding & Binding (Leaf Spring)

1. 短褲及男女用內褲褲頭或褲腳之鬆緊帶包縫，利用無段變速控制器，可精確調整鬆緊帶的鬆緊程度；運用操作簡便之膝動控制系統，控制鬆緊帶前後車縫，使車縫更完美
 2. 本裝置可接受鬆緊帶最大之尺寸為1 / 8" 到1 / 4" 之寬度
1. Elastic feeding ensures even length and elasticity controlled by leaf spring with elastic tape side-motion controller for sewing the beginning and ending of elastic tape onto waistband, leg opening of briefs, etc...
2. Maximum width of elastic is 1/8" to 1/4".

可自行組裝 self-installation : YES

適用機型 applicable model : F007K-W222, F007KD-W222



FHA

下擺車縫 Hemming

T恤、內衣、兒童服飾之下擺車縫；可隨需要調整下擺寬度，操作簡單
Suitable for bottom hemming of T-shirts, underwears, cuff of children's garments, etc... Able to adjust the width of hemming set to meet different demands, easy operation.

可自行組裝 self-installation : YES

適用機型 applicable model : F007K-W121, F007K-W122, F007K-W123, F007K-W162
F007KD-W121, F007KD-W122, F007KD-W123, F007KD-W162



FHK

二針三線·袖口自動車縫裝置 2 Needle 3 Thread Automatic Sleeve Hemming Device

1. T恤袖口、下擺氣動式自動送布、折布裝置·大幅節省人力及提升技術力
 2. 可依客戶車縫需求自行調整下擺折邊寬度 (附刻畫尺) · 下折布料距左針之左右寬度調整免裁切布料·節省材料成本
 3. 電眼自動檢測送布、折邊、抬壓腳裝置·作業完成後自動停機
 4. 最大產能約：6000件~7000件 (袖口) / 8小時
- 1.The pneumatic automatic feeding and folding device is for T-shirts sleeve hemming, which can save manpower and upgrade technique.
- 2.Customers can adjust the width of hemming folding edge and the horizontal width between folding fabric and left needle as required. Since there is no need to cut the fabric in advance material cost can be saved.
- 3.The electric eye can detect feeding, edging and presser foot lifter automatically. After finishing the action, the operation will stop automatically.
- 4.The maximum productivity: 6000 – 7000 pc (cuff)/ 8 hours.

可自行組裝 self-installation : NO

適用機型 applicable model : F007KD-U131, F007KD-U132



FL

後拉滾輪裝置 Rear Puller

適用於薄到中厚布車縫如：床單、被套、毛巾等 (較厚的硬滑布類不可適用) · 另附一組可調式下擺車縫組FHA (K)

Suitable for light to medium fabric, such as bedsheets, quilts, towels etc. With one set of adjustable bottom hemming device, FHA(K). (not suitable for the hard and slip fabric which is much heavy)

可自行組裝 self-installation : NO

適用機型 applicable model : F007K-W121/FHA, F007K-W122/FHA, F007K-W123/FHA,
F007K-W162/FHA, F007K-W222/FQ
F007KD-W121/FHA, F007KD-W122/FHA, F007KD-W123/FHA,
F007KD-W162/FHA, F007KD-W222/FQ



FP

折線條裝置 Crinkle Seaming

運動服裝·牛仔服飾或其他服飾之凸面折線條車縫·車縫時可於折線條內另加縫線繩·以增加凸線條之立體感和裝飾效果

To sew a decorative convex stripe on sportswears, jeans or other clothes, can also add extra stripe inside convex to increase the effects of convexity and decoration.

可自行組裝 self-installation : YES

適用機型 applicable model : F007K-U122-232, F007KD-U122-232



FQ

上帶滾邊車縫 Tape Binding

1. T恤、內衣褲、兒童服飾等之襯帶或包邊車縫
2. 本裝置與機器一起訂購時會加附FG組·但個別購買FQ元件時則不另附FG組
3. 喇叭標準規格為入布寬度1-3/8" · 出布寬度為1 / 2" · 捲成三折·若需要標準品以外之尺寸·請訂購時特別註明·但交期和費用另計
4. 本裝置有三種訂購方式：

1. For tape binding on openings of leg or underwear, T-shirt, etc...
2. If purchased machine with FQ, we will also attach FG. If purchase FQ device only, no FG attached.
3. Binder's standard opening size is 1-3/8" wide and finished size is 1/2" wide in 3 folds. Please remark if need another size when ordering, delivery date and cost will be re-calculated.
4. Ways to order the device:

機型 Model	FQ	FG	FQ 規格組 FQ Gauge Set	喇叭 Binder
F007K-W222-240/FQ	√	√	√	√
F007K-W222-240	X	X	√	X
F007K-W222-240/FQP	√	√	√	X

可自行組裝 self-installation : YES

適用機型 applicable model : F007K-W222, F007KD-W222

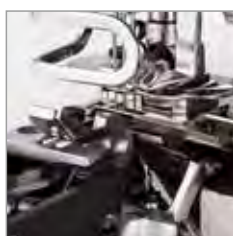

FR

右切刀修布裝置 Right Hand Side Trimmer

修齊兩片布接縫之下方多餘之布料，使車縫品質更加美觀

Right hand side waste fabric trimming, ensures better sewing quality.

可自行組裝 self-installation : NO

適用機型 applicable model : F007K-W522



FSM 花飾滾邊車縫 Ornamental Tape Binding

適用於T恤衫、襯衫等領口及下擺、袖口等花飾滾邊車縫，附有四組花飾凸輪可變化成數百種車縫花樣

Suitable for ornamental tape binding of neck band, bottom or cuff of T-shirts, shirts, etc... Four sets of cam create hundreds of patterns.

可自行組裝 self-installation : NO

適用機型 applicable model : F007K-W222, F007KD-W222



FSP

雙勾針上布條裝置 Double Looper Tape Binding

雙針雙勾針布條貼縫裝置，例如男內褲門襟

This device is specially designed for tape binding on cross seaming of men's briefs or sportswears.

壓具代碼 Presser Foot Code	入布寬度 Tape Width	出布寬度 Finish Width	適用機型 Applicable Model
P5118 (含喇叭) P5118 (binder included)	25mm	12mm	F007K(D)-U712A
P5117 (含喇叭) P5117 (binder included)	21mm	10mm	F007K(D)-U712

可自行組裝 self-installation : NO

適用機型 applicable model : F007K-U712, F007KD-U712

**FSR****捲疊縫 Lap Seaming**

本機種設計特殊之左右齒差動方式，能使捲疊縫縫紉更順暢，車縫後左右兩片均一無長短之虞；適用於西褲、休閒褲、牛仔褲薄至厚布料等之捲邊疊縫

Differential ratio of left and right feed dog can be adjusted separately for lap seaming to ensure symmetrical length to both left and right fabric. Applicable to trousers, casual pants and jeans, etc...

可自行組裝 self-installation : NO

適用機型 applicable model : F007K-U712, F007KD-U712

**FW****FWP****四針六線環縫車縫裝置 Four-needle Flat Seaming**

用於一般內衣褲二片布接縫處之接縫和補強，無需先經由拷克車拷邊再飾縫，牢固美觀，可附加喇叭 (B417R) 做貼帶補強用組件代號FWP

For flat seaming 2 pieces of fabric, equipped with fabric guide for easy operation.

FWP: Folder(B417R) is optional, for tape attaching.

可自行組裝 self-installation : NO

適用機型 applicable model : F007K-W922, F007KD-W922

**FY****褲袋裡布車縫 Pocket Lining Seaming**

用於褲袋之縫製，三針三勾一上叉針可強化縫合，增加產品之牢固。西服、工作服等衣袋和褲袋內裡之縫紉工程

This is a 3 needles 3 loopers 1 spreader machine, and special for seaming the shell fabric and lining of pocket in trousers or working pants in simple operation to increase sewing quality and efficiency.

可自行組裝 self-installation : NO

適用機型 applicable model : F007K-W722, F007KD-W722

**LFA-A□****直向電動送帶裝置 Electric Tape Feeding Device**

利用電子馬達帶動鬆緊帶，使其放鬆到零鬆緊狀況，並可控制所需鬆緊帶之長短，使車縫時鬆緊度能一致

□代表電壓，1: 110V, 2: 220V

Elastic type is fed by electric motor to achieve zero tension. Elastic tape length can be easily adjusted to expect length to ensure elasticity consistency.

□=voltage, 1: 110V, 2: 220V

可自行組裝 self-installation : YES

適用機型 applicable model :

C007K/FE, C007K/FFC, C007K/CR/FE, C007K/CR/FFC, C007K/CR/FFC, C007KD/FE, C007KD/CR/FE, F007K/FE, F007K/FFC, F007K/FFD, C007KP/CR/FFC, F007K/FFP, F007K/FSP, F007K/FBP, F007K/FWP, F007K/FR/FE, F007K/FR/FFC, F007KD/FE, F007KD/FFP, F007KD/FSP, F007KD/FBP, F007KD/FWP



LF290 抖帶輪 Untangle Wheel

-A □

可選配安裝於LFA (送帶裝置) · 以逆轉的方式 · 抖動鬆緊帶 · 做為送帶前的處理
□代表電壓 · 1: 110V · 2: 220V

An optional device to be equipped with LFA (tape feeding device). Untangling the elastic tape by reverse rotation wheel is a pre-feeding process.

□=voltage, 1: 110V, 2: 220V

可自行組裝 self-installation : YES

適用機型 applicable model : MODEL w/LFA



LS-A 上方帶盤 Upper Tape Holder

置於上前方放布條或鬆緊帶

For top feeding tape or elastic.

可自行組裝 self-installation : YES

適用機型 applicable model :

C007K/FE, C007K/FFC, C007K/GR/FE, C007K/CR/FFC, C007KD/FE, C007KD/GR/FE, F007K/FE, F007K/FFC, F007K/FFD, F007K/FFP, F007K/FSP, F007K/FBP, F007K/FWP, F007K/FR/FE, F007K/FR/FFC, F007KD/FE, F007KD/FFP, F007KD/FSP, F007KD/FBP, F007KD/FWP



PCC 拷克倒骨蓋縫裝置 Overlock-Seam Covering (Fold-down Type)

1. 適中厚至厚布料經四線拷克車包縫後之飾縫

2. 對於運動服、領子、衣襟、袖管之拷邊車縫後加以單面或雙面裝飾環縫 · 可增加服飾之美觀及車縫之牢固。利用導布片及壓具上之壓刀導縫 · 可避免車縫時彎曲不直

1.Overturned seam covering for medium to heavy fabric after 4 thread plain seaming.

2.Suitable for neck openings, sleeve, cuff or bottom of sportswears, T-shirts, etc...

With fabric guide and special presser foot, making sewing easy and more efficient.

可自行組裝 self-installation : YES

適用機型 applicable model : S007K all models, S007KD all models



PCD 拷克倒骨蓋縫裝置 Overlock-Seam Covering (Fold-down Type)

1. 適中厚布料經四線拷克車包縫後之飾縫

2. 對於運動服、領子、衣襟、袖管之拷邊車縫後加以單面或雙面裝飾環縫 · 可增加服飾之美觀及車縫之牢固。利用導布片及壓具上之壓刀導縫 · 可避免車縫時彎曲不直

1.Overturned seam covering for medium fabric after 4 thread plain seaming.

2.Suitable for neck openings, sleeve, cuff or bottom of sportswears, T-shirts, etc...

With fabric guide and special presser foot, making sewing easy and more efficient.

可自行組裝 self-installation : YES

適用機型 applicable model : S007K all models, S007KD all models



PCE 拷克立骨蓋縫裝置 Overlock-seam Covering (Flattening Type)

1. 適中厚布料經三線拷克車包縫後之飾縫

2. 對於運動服、領子、衣襟、袖管之拷邊車縫後加以單面或雙面裝飾環縫 · 可增加服飾之美觀及車縫之牢固。利用導布片及壓具上之壓刀導縫 · 可避免車縫彎曲不直

1. Bulging seam covering for medium fabric after 3 thread plain seaming.

2. Suitable for neck openings, sleeve, cuff or bottom of sportswears, T-shirts, etc...

With fabric guide and special presser foot making sewing easy and more efficient.

可自行組裝 self-installation : YES

適用機型 applicable model : S007K all models, S007KD all models



PCH

下擺車縫 Bottom Hemming

T 恤、內衣及兒童服飾之下擺及袖口之車縫。可隨需要調整下擺飾縫組寬度。操作簡單快捷
Suitable for the bottom hemming of T-shirts, underwears, cuff of children's garments, etc...
Able to adjust the width of hemming set to fit demands, easy operation.

可自行組裝 self-installation : YES

適用機型 applicable model : S007K all models, S007KD all models



RL

筒型衣物撐開滾輪組(長輪) Tubular Extending Roller (Long Type)

專用於輔助筒型衣物之車縫
Especially used to assist with tubular cloth sewing.

可自行組裝 self-installation : YES

適用機型 applicable model : C007K/CY, C007KD/CY, C007L, C007JP



RLP

筒型衣物撐開滾輪組(短輪 + 斜輪) Tubular Extending Roller (Short+ Cone Type)

專用於輔助筒型衣物之車縫
Especially used to assist with tubular cloth sewing.

可自行組裝 self-installation : YES

適用機型 applicable model : C007K/CX, C007KD/CX



RLQ

筒型衣物撐開滾輪組 Tubular Extending Roller

專用於輔助筒型衣物之車縫
Especially used to assist with tubular cloth sewing.

可自行組裝 self-installation : YES

適用機型 applicable model : C007K/CZ, C007KD/CZ



SMK

電子計數式送帶 Electric Metering type tape feeding

SMK1 - □ - □

A: 包縫機 · 上送帶
Overlock, Top Feed
C: 繃縫機 · 上送帶
Interlock, Top Feed
D: 繃縫機 · 下送帶
Interlock, Bottom Feed
E: 繃縫機 · 側送帶
Interlock, Side Feed

O1 附定位器 · 適合簡易伺服或離合器馬達
With synchronizer for simple servo motor or clutch motor
O2 以中繼線 · 連接伺服馬達
Connected to servo motor by encoder cable

可自行組裝 self-installation : YES

適用機型 applicable model : C007K-W512, C007K/CR, F007W512, F007/CR



SRL 左切刀修布裝置(小筒用) Left Hand Side Trimmer (For Small Cylinder Bed)

修齊兩片布接縫左下方多餘之布料·使車縫後更加整齊美觀
Left edge trimmer makes fabric edge aligned to seam.

可自行組裝 self-installation : NO
適用機型 applicable model : S007KD-815



STC 張力控制式送帶 Tension sensor type tape feeding

STC1 - □ - □

U: 上送帶
Top Feed
B: 下送帶
Bottom Feed
S: 側送帶
Side Feed

01 附定位器·適合簡易伺服或離合器馬達 With synchronizer for simple servo motor or clutch motor
02 以中繼線·連接伺服馬達
Connected to servo motor by encoder cable

可自行組裝 self-installation : YES
適用機型 applicable model : C007K-W512, C007K/CR, F007-W512, F007/CR

UT□ 自動切線組 Automatic Thread Trimmer Set



上切
Top Trimmer



下切
Bottom Trimmer

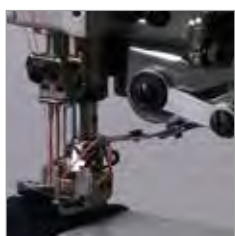

夾線
Thread Gripping







吹風
Thread Blowing

機型 Model	代號 Code	功能 Function				驅動 Drive	
		上切 Top Trimmer	下切 Bottom Trimmer	夾線 Thread Gripping	吹風 Thread Blowing	氣動 Pneumatic	電動 Electrical
F007K F007KD	UTG	√	√		*	√	
	UTH		√	選配 Optional	√		
	UTJ	√	√				√
	UTK		√	√			
C007K C007KD C007L	UTP	√	√		*	√	
	UTQ		√	選配 Optional	√		
	UTR	√	√				√
	UTS		√	√			
S007K F007KD	UTT	√	√		*	√	
	UTU		√	選配 Optional	√		
	UTX	√	√				√
	UTY		√	√			



*配件盒附吹風管·客戶若不需上網線時·可自行將上切刀改為吹風
Thread blowing device is included in the accessory box. If the coverstich thread is not required, users may install blowing device instead of upper thread trimmer.

TABLE

桌板代號 Item No.	尺寸 / Size (mm)			說明 Description	適用機型 Applicable Model	備註 Remark
	長 Length	寬 Width	厚 Thickness			
C007L-T23	1200	540	45	半沉式 Semi-submerged	C007L, C007LX	
C007L-T25	1200	540	45	上乘式 Non-submerged	C007L, C007LX	
C007K-T23	1200	540	45	半沉式 Semi-submerged	C007K, C007KD, C007JP, S007K, S007KD	
C007K-T25	1200	540	45	上乘式 Non-submerged	C007K, C007KD, C007JP, S007K, S007KD	
C007K-T26	1200	540	45	半沉式 Semi-submerged	C007K/CFC	
F007K-T	1200	540	45	半沉式 Semi-submerged	F007K, F007KD	
F007K-T3	1200	540	45	全沉式 Fully-submerged	F007K, F007KD	
F007K-T1	1200	540	45	半沉式 Semi-submerged	F007K/FR, F007KD/FR	
F007K-T2	1200	540	45	上乘式 Semi-submerged	F007K/FFT/FHK	