

2

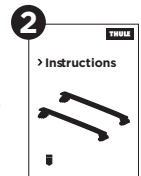

# > Instructions

Thule Evo Flush Rail  
710601

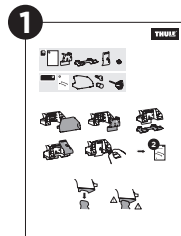
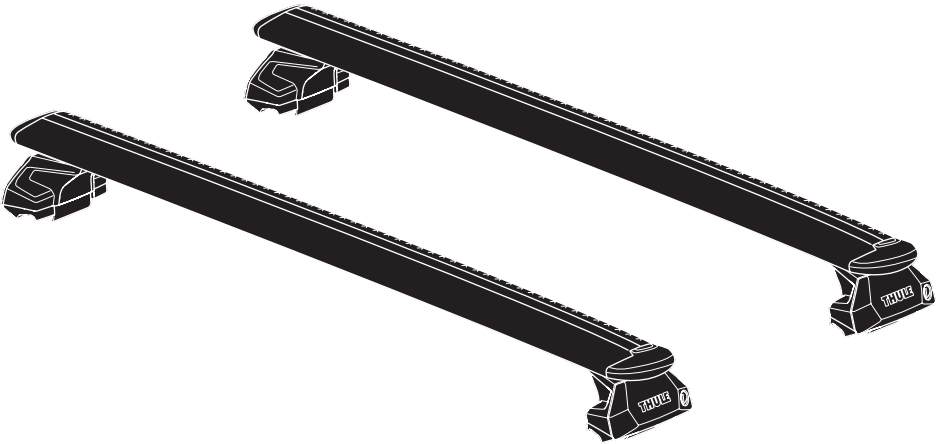

THULE.COM

**EN** Roof mounted load carrier  
**DE** Lastenträger zur Dachmontage  
**FR** Barre de toit  
**NL** Dakdrager  
**IT** Barra portatutto da installare sul tetto  
**ES** Portaequipajes de techo  
**PT** Barra para montagem no tejadilho  
**SV** Takmonterad lasthållare  
**DK** Tagmonteret lastholder  
**NO** Takmontert lasteholder  
**FI** Katolle asennettava teline  
**ET** Katusele paigaldatav katuseraam  
**LV** Uz jumta uzstādāms kravas turētājs  
**LT** Ant stogo tvirtinamas krovinijų laikiklis  
**PL** Uchwyty na bagażnik bazowy montowany na dachu  
**RU** Багажник на крышу  
**UK** Багажник для даху  
**BG** Багажник, монтиран върху покрива  
**CS** Nosič pro montáž na střeche  
**SK** Strešný nosič  
**SL** Nosilec za strešni prtljajnik  
**HR/BIH** Krovni nosač tereta

**RO** Suport încărcătură montat pe acoperiș  
**HU** Tetőre szerelhető csomagszállító  
**EL** Σχάρα οροφής για μεταφορά φορτίου  
**TR** Araç üstüne bağlanan yük taşıyıcı

**ZH** 顶行李架  
**JA** ルーフマウント型ロードキャリア  
**KO** 루프 장착 화물 캐리어  
**TH** โครงยึดของบรรทุกแบบติดตั้งบนหลังคา

**HE** מנשא מטען לגג הרכב  
**AR** حامل نقل مثبت على السقف

**CITY CRASH**  
 Complies with ISO norm

ISO 11154-E

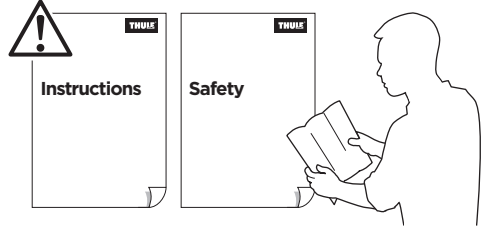

**i**



**i**

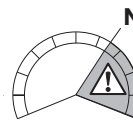

Max 130 km/h  
80 Mph

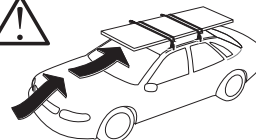
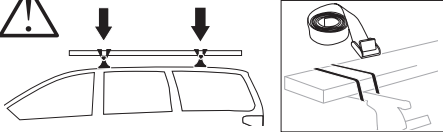

80 km/h  
50 Mph

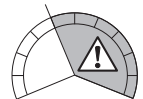

## ► Mounting Tutorial

Thule Evo Flush Rail



**1**  
KIT

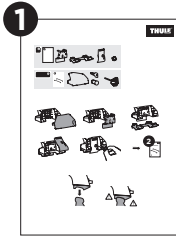

+

**2**  
FOOT PACK

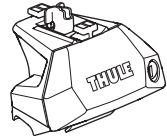
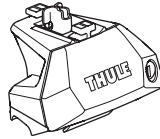
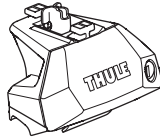
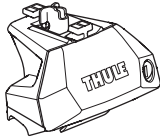
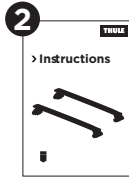

**3**  
BAR

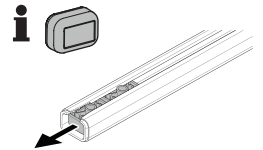
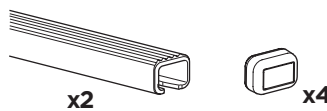
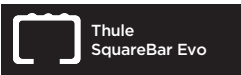
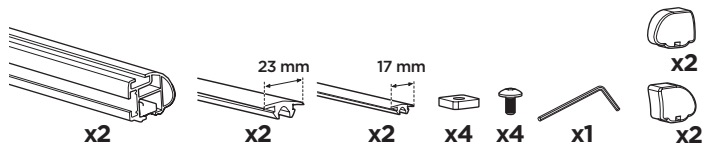
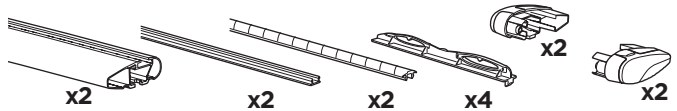
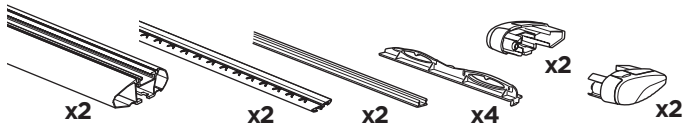

1

BAR

3



Thule  
WingBar Evo

A

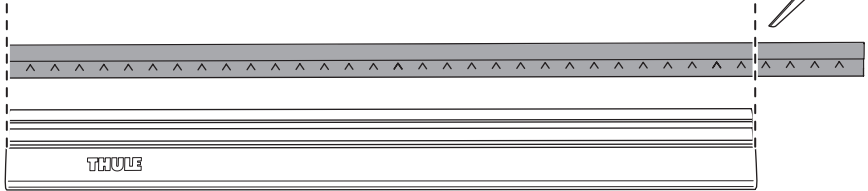

B

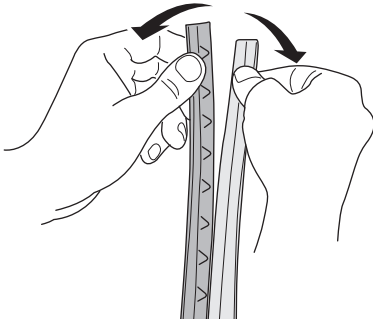

C

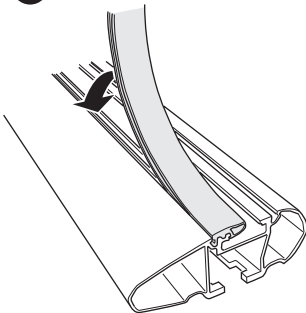

D

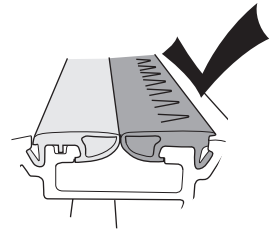
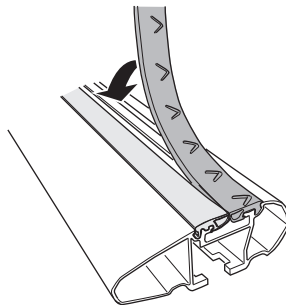

 Thule  
AeroBlade

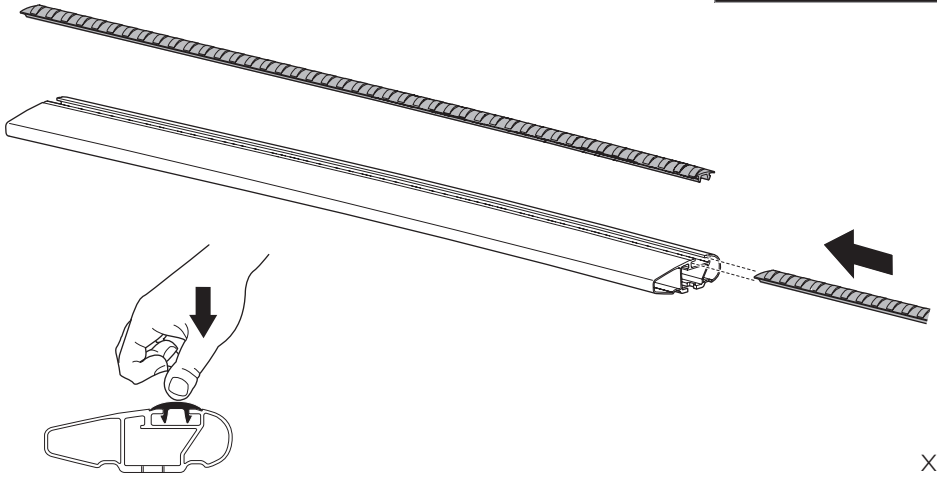

2

BAR

3

A

 Thule  
WingBar Evo

B

 Thule  
AeroBlade

C

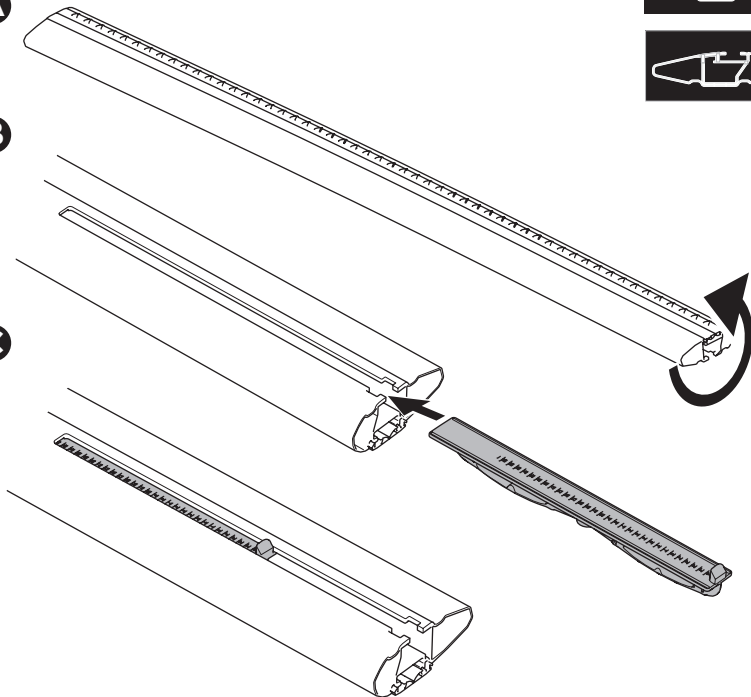

3

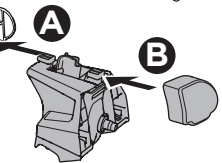
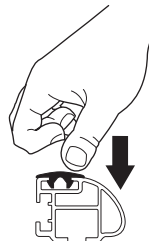
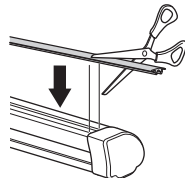
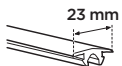
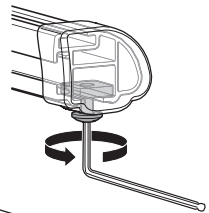
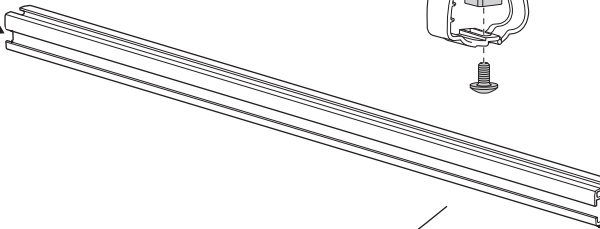
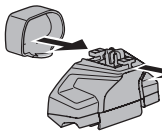
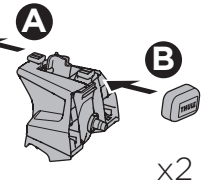
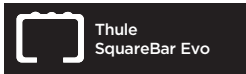
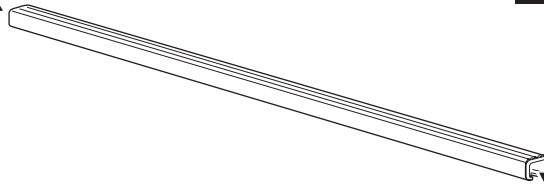
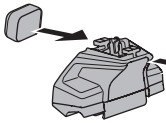
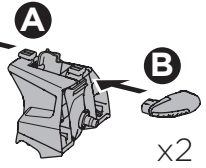
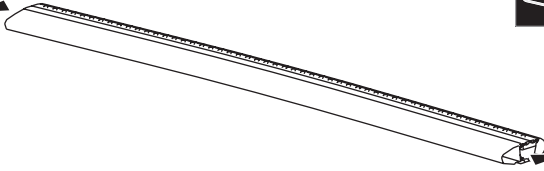
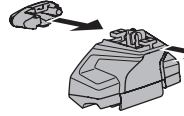

4

A

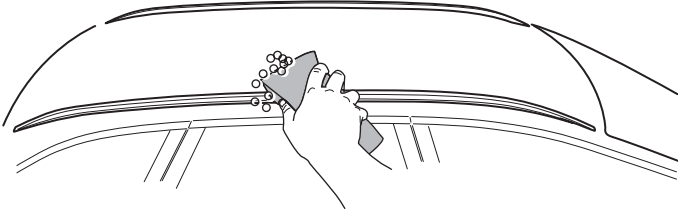

B

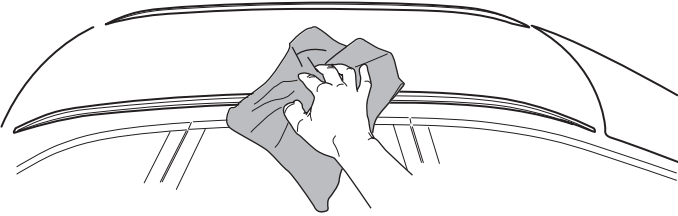

5

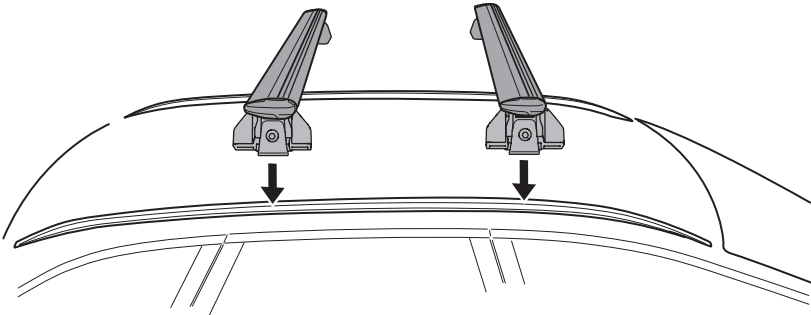
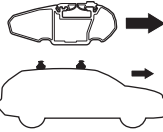

6

~ 700 mm

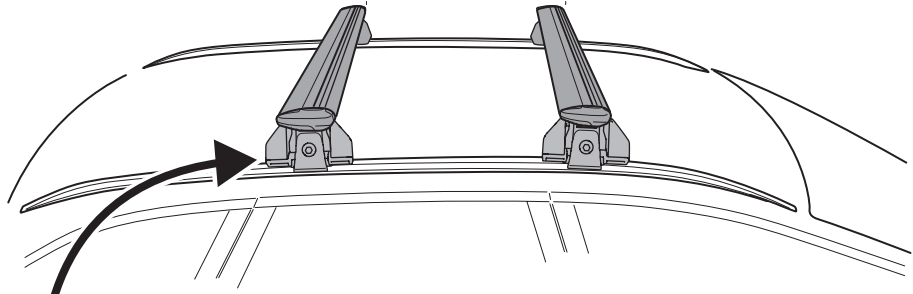

1

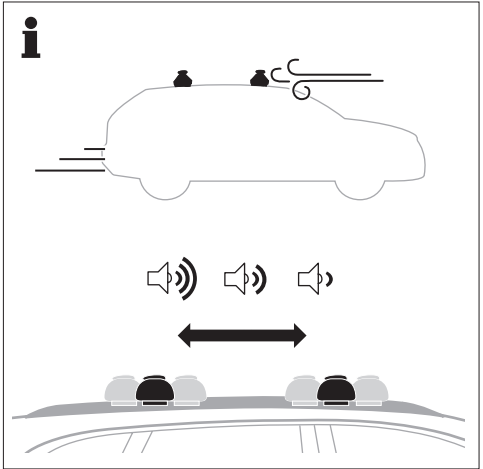
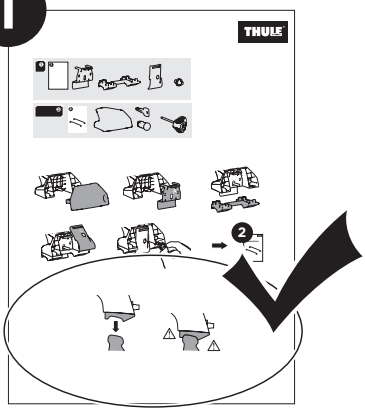

7

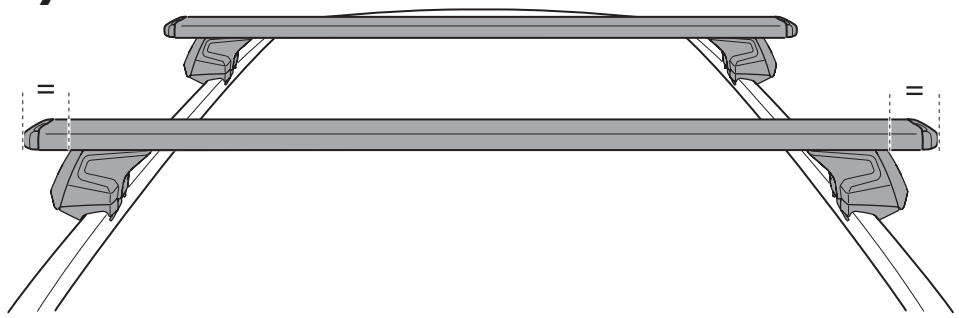



8

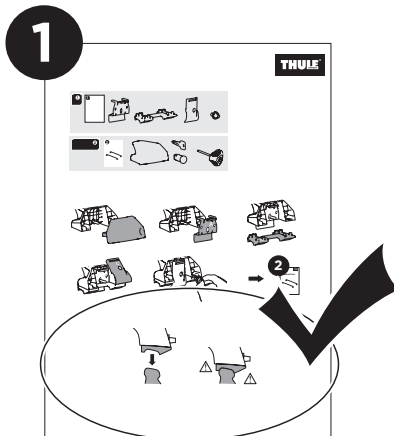
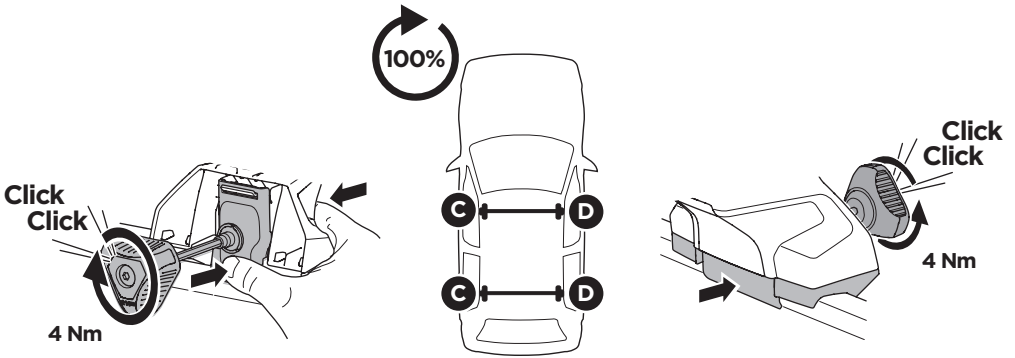
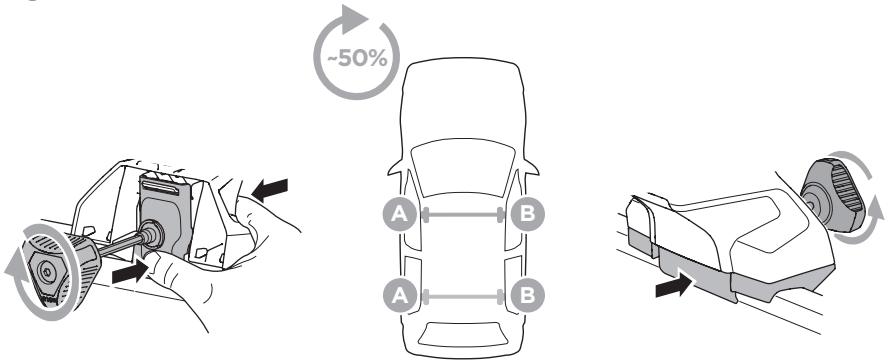

9

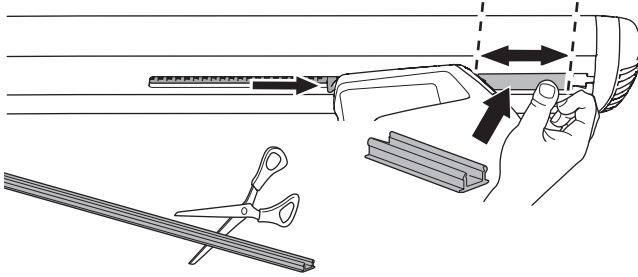

x4

17 mm

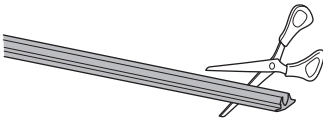
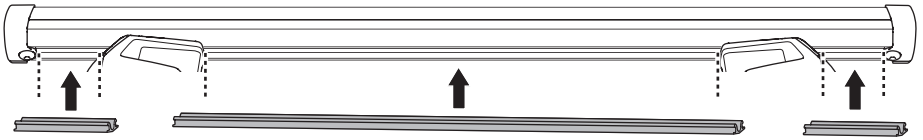
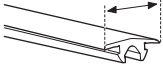

x2

10

A

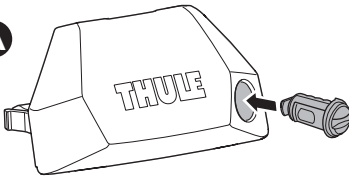

B

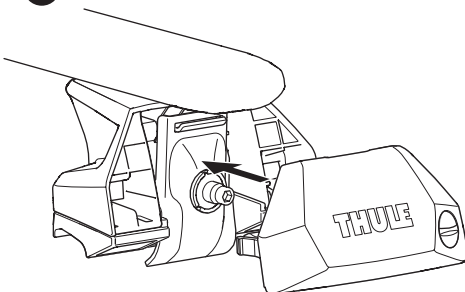

C

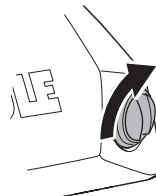

x4

**i** Accessory

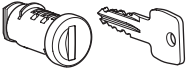

**A**

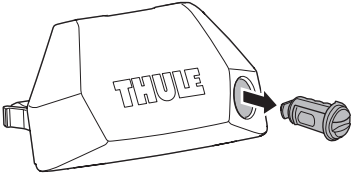

**B**

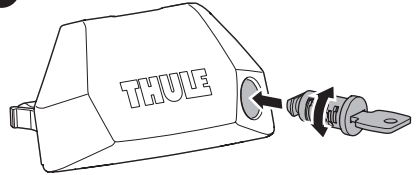

**C**

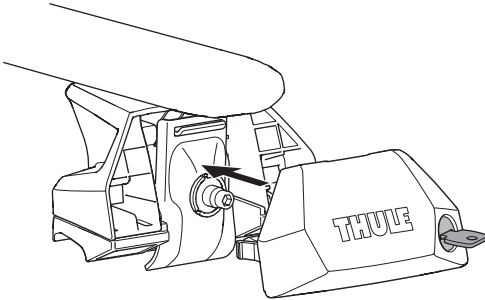

**D**

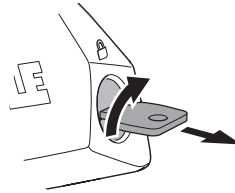

x4

**11**

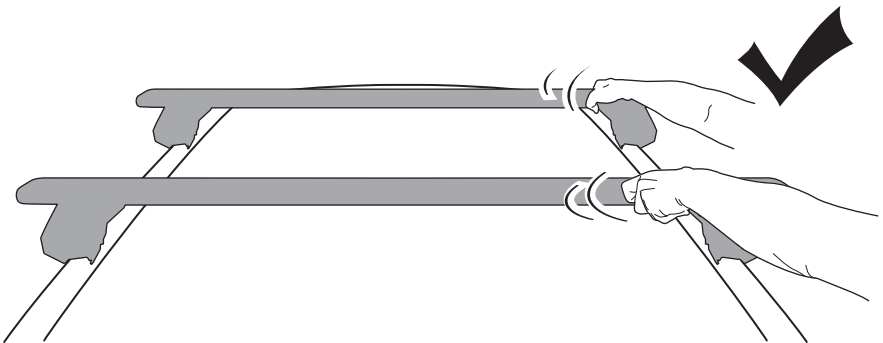

**i**

