

Use and Care Guide

# GEN1<sub>Series</sub>



GEN-1 LPG



Thank you for equipping your RV, coach, or caravan with an Aqua-Hot heating system! We deeply value your business and we are grateful for the trust you have placed with Aqua-Hot Heating Systems, LLC. Our customers are our top priority and we are committed to providing best-in-class products, service, and support.

We understand how important comfort is to you as a recreational vehicle or manufactured home owner; therefore, we have designed a heating system to significantly improve all of your comfort levels. Additionally, the Aqua-Hot heating system is a low-emissions, fuel efficient system that adds thousands of dollars in value to your RV or home.

We know that you must be eager to get underway, but take time to read and understand this Use and Care Guide to understand the basic functionality of the Aqua-Hot. This guide should be maintained in legible condition and kept in a safe, accessible location for future reference.

Should you have any suggestions on how we can better serve you, please do not hesitate to contact us.

Technical Support can be contacted at 574-AIR-XCEL (574-247-9235). Hours of operation are 7:00am to 4:00pm (MST) Monday through Friday.

The Aqua-Hot heating system is protected by the finest warranty in the industry (read about it at the back of this manual).

**Important Notes:**

- A qualified installer or service technician must perform equipment installation or service. Contact Aqua-Hot for more information at [www.aquahot.com/service-help](http://www.aquahot.com/service-help), or call us at 574-AIR-XCEL (574-247-9235).
- Warranty work must be performed by an Aqua-Hot Factory Authorized Service Center.
- Your on-product identity label contains the specifications of your unit. Factory settings may be adjusted by the vehicle manufacturer, confirm final setting with your dealer.



- Follow this guide exactly. Failure to do so may result in a fire or explosion resulting in property damage and/or personal injury.

**Contents**

Caution Notes..... 2  
 Safety Features ..... 3  
 Component Call-outs ..... 5  
 System Features ..... 6  
 Operational Overview..... 7  
 Operating the LCD..... 8  
 Aqua-Hot Layout ..... 14  
 Maintenance & Storage..... 15  
 Winterizing the Aqua-Hot ..... 16  
 General Troubleshooting..... 17  
 Owner’s Service Log ..... 18  
 Warranty ..... 20

**Caution Notes**

As you read this information, take particular note of the NOTICE, CAUTION, WARNING, and DANGER symbols when they appear. This information is important for safe and efficient use of the Aqua-Hot system.

**NOTICE** signals a situation where potential damage to the Aqua-Hot could occur.



**CAUTION** signals a situation where potential harm or risk of minor or moderate injury could occur if you do not follow instructions.



**WARNING** signals a hazardous situation where potential harm, risk of serious injury, or death could result if instructions are not followed.



**DANGER** signals a situation where immediate risk of serious injury or death will result if instructions are not followed.



**NOTE:** This manual will also use notes sections similar to this one to draw attention to features and practices which must be observed.

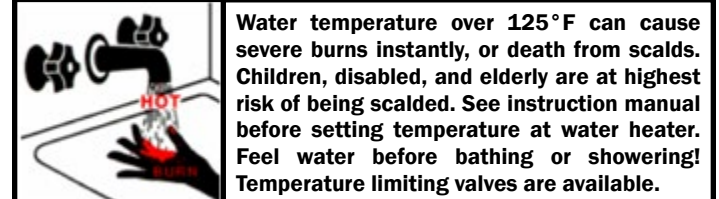

WARNING

**WHAT TO DO IF YOU SMELL GAS**

- Evacuate all persons from the vehicle.
- Shut off the gas supply at the gas container or source.
- Do not touch any electrical switch or use any phone or radio in the vehicle.
- Do not start the vehicle’s engine or electric generator.
- Contact the nearest gas supplier or qualified service technician for repairs.
- If you cannot reach a gas supplier or qualified service technician, contact the nearest fire department.
- Do NOT run the first operation until it has been confirmed there are no gas leaks.
- Do not turn on the gas supply until the gas leak(s) have been repaired.

**THE AQUA-HOT’S EXHAUST IS HOT!**

- Do NOT operate the burner inside an enclosed building.
- The heater must be switched OFF when refueling.
- The heater is not to be operated while the vehicle is being refueled, if the towing vehicle is being refueled, if the vehicle is in motion, or if the vehicle is in an enclosed space.
- The heater is not to be used while the any appliances are being refueled or serviced.
- Aqua-Hot will not be liable for problems and/or damage caused by the system installed by untrained technicians.

Read and understand all instructions **before** using the Aqua-Hot system. Aqua-Hot Heating Systems is not liable for damage resulting from failing to follow instructions contained in this, and any other Aqua-Hot documentation relevant to this unit.

- Read this manual **before** using the Aqua-Hot System to reduce the risk of injury to persons or damage to the equipment.
- The product identity label contains specifications of the unit, to what standards it has been tested, and important safety notices.



- Disconnect electric wiring to the Aqua-Hot System before welding or plasma cutting the RV to avoid damage to the electrical components.
- The GEN-1 tank **must** have a cold water inlet pressure regulator set to 45PSI or below to avoid damage to the tank.
- Use caution when working on or near any propane system.
- DO NOT connect the 12-volt DC power to the Aqua-Hot if the vehicle requires welding.
- Use special caution when children are present. Children must not be allowed to play with the heater or perform cleaning and maintenance.
- At maximum operating temperature, the hot air outlet could be very hot that may result in serious burns or injury. Be aware of hot surfaces.
- The burner produces very hot temperatures that can ignite surrounding flammable materials. The burner should be turned off when loading or unloading flammable materials.

## System Overview

The Aqua-Hot Gen-1 Heater is a Heating System that can provide interior heat and hot water using a built-in electric heating element and a propane burner. The heater can be used while driving.

There are three options for heating:

- **LPG Mode:** the heater automatically adjusts power according to temperatures.
- **Electric Mode:** manually select either the 900W or 1800W heating mode according to the power supply capacity of the shore power.
- **Hybrid Mode:** the system will control the use of electric and LPG heating based on the power demand on the system.

## Important Notes:

- Service and repairs may only be carried out by a qualified technician.
- Aqua-Hot will not be liable for problems or damage caused by the system being repaired/serviced by unqualified technicians.
- Your on-product identity label contains the specifications of your unit. Factory settings may be adjusted by the vehicle manufacturer, confirm final setting with your dealer.
- The Aqua-Hot heating system operates independently of the vehicle engine and is connected directly to the electrical system of the vehicle or towable.
- Please read this manual and follow instructions to avoid injuries during installation and/or operation.



**If the information in this manual is not followed exactly, a fire or explosion may result, causing property damage, personal injury or death.**



**In order to avoid overheating, do NOT cover the heater.**

## Safe Operation

The Aqua-Hot Heating system consists of an electric heating element and a propane burner. The heater with supplementary indirect water heating is for use in RVs only to heat the space and domestic water.

The room heater works by pulling air into the heater by a fan, heated up, and dispensed into the RV's interior by ductwork.

The water heating is installed between the fresh water supply line and the hot water system.

Locate the LCD screen (shown below) inside the RV (contact the vehicle manufacturer if unable to find), press and hold the turn knob to wake, use the rotary button to select the desired heat mode. Click the rotary button to confirm. It will take approximately 20 minutes for the heater to get to operating temperature. After the GEN1 is to temperature, you can activate interior heat in your coach via the thermostat/LCD or run hot water.

## Intended Use

This manual explains the operation and care of the Aqua-Hot heating system.

- Service and repairs may only be carried out by a qualified technician.
- The vehicle owner is responsible for correct operation of the appliance.
- All vehicle installations must comply with the requirements listed in the Recreational Vehicle Industry Association's (RVIA) ANSI/NFPA 1192 Handbook for Recreational Vehicle Standards.
- Make sure to properly drain winterize the Aqua-Hot's water tank when not in use and/or any time the heater is stored where freezing temperatures may be experienced. The Aqua-Hot warranty will not cover claims for freeze damage. Please refer to page 10 for proper winterization of the Aqua-Hot.



**Figure 1**

Aqua-Hot GEN-1 Heater	
1.	Heater
2.	Air Intake Inlet
3.	Exhaust Outlet
4.	Controller Cover
5.	Plastic Frame Feet
6.	Aluminum Frame Feet
7.	Circulated Air Intake
8.	Cold Water Connection (Inlet)
9.	LPG Fuel Connection
10.	Hot Water Connection (Outlet)
11.	Fan for Intake Air
12.	Water Tank
13.	Warm Air Outlets (Upper)
14.	Warm Air Outlets (Lower)
15.	Recessed Grips
16.	Electronic Control Unit
17.	LCD Control Screen

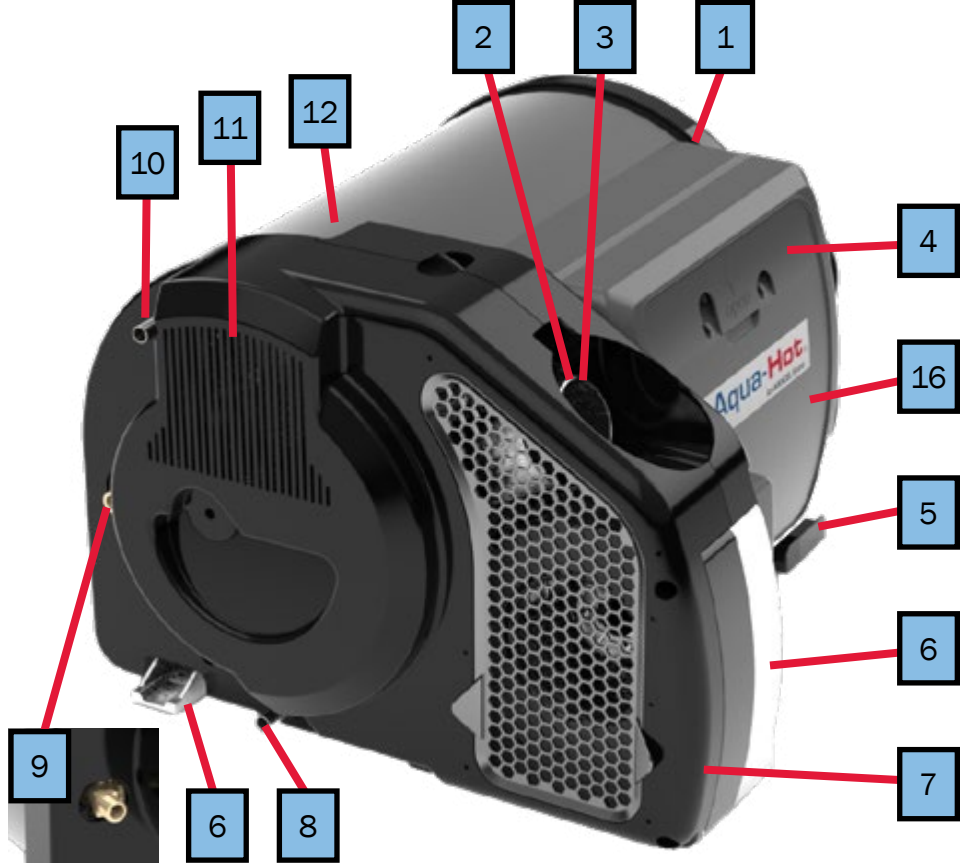

Figure 2

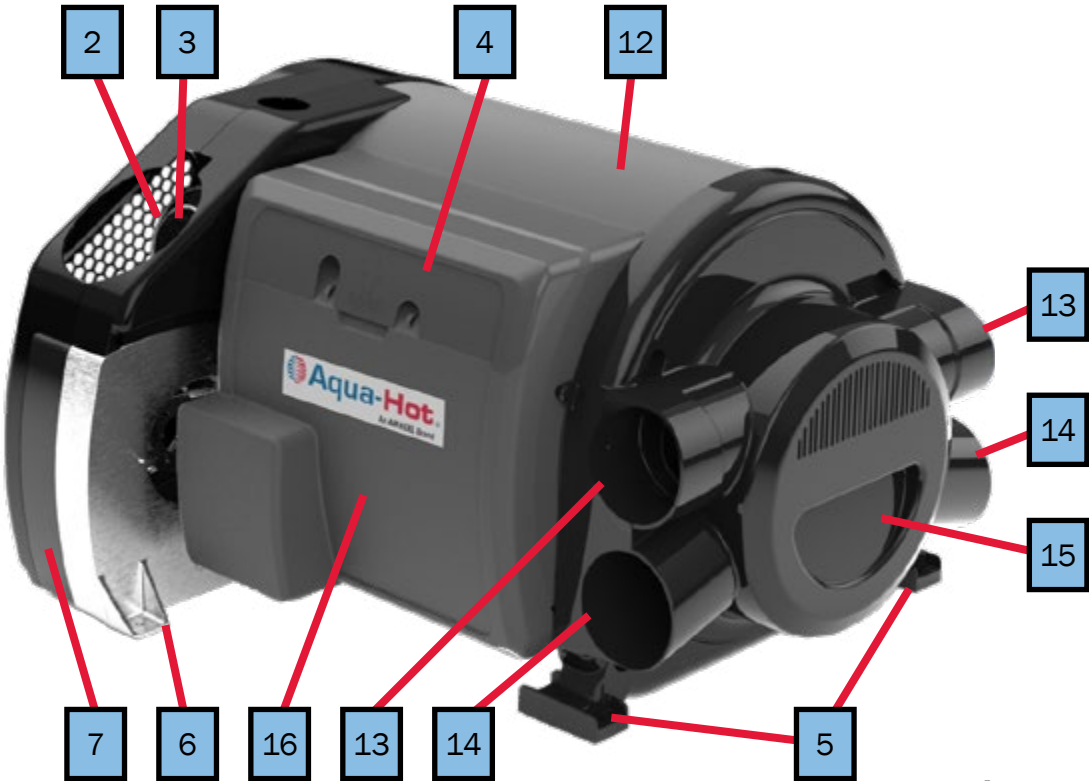

Figure 3



Figure 4



## System Features

The Aqua-Hot Gen-1 Heater is a Heating System that can provide interior heat and hot water using a built-in electric heating element and a propane burner. The heater can be used while driving.

### The Aqua-Hot Heating System is a 2-in-1 system

There are three options for heating:

- **LPG Mode:** the heater automatically adjusts power according to temperatures.
- **Electric Mode:** manually select either the 900W or 1800W heating mode according to the power supply capacity of the shore power.
- **Hybrid Mode:** the system will control the use of electric and LPG heating based on the power demand on the system.

When plugged into shore power, or powered by a generator, the electric element lets you use the power you are already paying for to provide heat in mild conditions and meet your light duty hot water needs.

The propane burner can be utilized with the electric element to heat and supplementary produce hot water.



**For full details and installation requirements, please see installation and owners manuals.**

**Minimum Service Clearances:**  
**Front: 4 inches**  
**Back: 1 inch**  
**Sides: 0.5 inches**  
**Top: 2 inches**  
**Bottom: No Clearance Necessary**

This appliance must be installed in accordance with local codes, or in absence of local codes, the Standard for Recreational Vehicles, ANSI A119.2/NFPA 1192 or CAN/CSA-Z240 RV.



**Meets or Exceeds: ANSI Z21.47 CAN/CSA 2.3**

**Listing 20L01**

Max Tank Pressure	65 PSI
Tank Capacity	2.6gal (10L)
Power (DC)	12VDC, 10A, 120W Max
Power (AC)	120VAC, 15.6A, 1800W Max
Fuel Pressure	12 ±1 inches of water
Burner	Propane, 20470 BTU/hr

**Model: Gen 1**  
**Serial Number:**

**NOTE:** This product label is attached to the side of the Aqua-Hot, and provides a ready reference to specifications, test standards, and important safety notices.

All vehicle installations must comply with the requirements listed in the Recreational Vehicle Industry Association's (RVIA) ANSI/NFPA 1192 Handbook for Recreational Vehicle Standards.

## Operational Overview

The heating features are powered by the DC propane burner and/or the AC electric element. These maintain the temperature of the GEN1's tank to provide supplementary hot water and interior heat.

### Propane Burner & Electric:

The propane burner is the Aqua-Hot's primary and most powerful heat source.

The electric element is the Aqua-Hot's secondary heat source and can be used when plugged into shore power.

These heat modes can be activated by turning them on by selecting the fuel source (GAS/EL/MIX) on the LCD screen shown to the right.

There are 4 modes: OFF, ECO, HOT, and BOOST. In ECO mode, the heat mode will get the tank temperature to 104°F. In HOT mode, the heat mode will get the tank to 140°F. In BOOST mode, the heater prioritizes water heating for 40 minutes or until the water temperature reaches 60°C (140°F).

The system uses temperature readings from the RV interior thermistor. In OFF mode, the burner is off and will not provide any heat to the interior or water.



Figure 5



Figure 6

### Controlling Heat Levels with Room Thermostat:

When the GEN1 is on and up to operating temperature, adjust the room thermostat to the desired temperature and it will automatically activate the GEN1's heating functions to maintain the desired interior temperature.

Different manufacturers may use different types of thermostats. Please contact the dealer or manufacturer for the exact type, location, and thermostat operation.

Working Mode	Energy Mode
OFF	Water heating is off - icon will not show
ECO	Water Temperature target of 104 °F
HOT	Water Temperature target of 140 °F
BOOST	Prioritizes water heating for 40 minutes or until the water temperature reaches 60 °C (140 °F)



## Operating the LCD

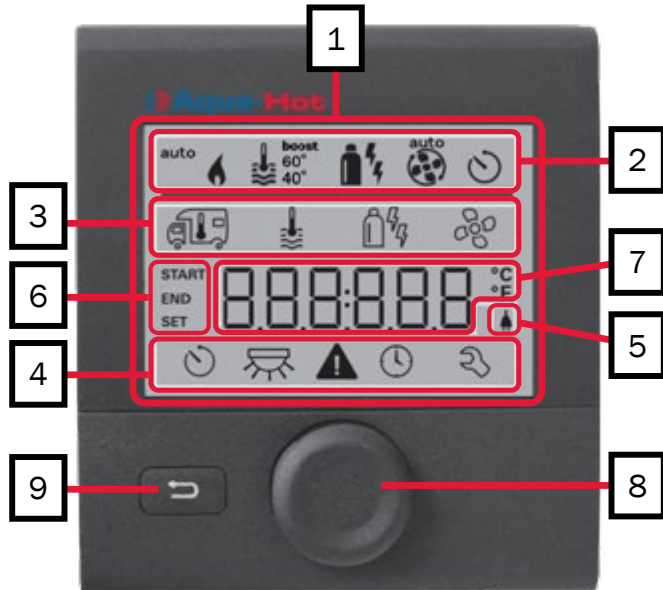

<b>1</b> Display Area	<b>6</b> Timing Display
<b>2</b> Status Display	<b>7</b> Parameter Setup Display
<b>3</b> Menu Bar (top)	<b>8</b> Rotary Button/Knob
<b>4</b> Menu Bar (bottom)	<b>9</b> Return Button
<b>5</b> 110/220V Electrical Display	

### Display and Control Section:

- The information is displayed on the screen with a back-light
- In the menu bar (#3, 4), the function of the LCD can be selected. The operating parameters are shown on the status bar (2) and display bar (5, 6).
- After the 110V is supplied to the system, the 110V power supply indication column (5) displays the power supply sign
- During heater operation, set the parameter bar (7) to display start/end times, and room temperature.
- Press the return button (9) to return to previous interface.

### Rotary button (8)

- Select, modify, and save icons for menu bars 3 & 4 by rotating the knob.
- Tap the button to confirm saving and return to main menu.
- Press and hold the button (+3seconds) to turn on/off LCD.

### Power ON:

Hold the rotary button for 3seconds to turn on LCD. After a few seconds, the time is displayed as 00:00.



Click the rotary button to display the initial options in the display.



### Clock setting (current time setting)

- Click the rotary button to display the icon in the menu bar (3).



- Use the rotary button to select "Set Clock" icon in the menu bar (4).
- Click the rotary button to enter the clock settings.



- Use the rotary button to set the time. "A-" is displayed in the morning and "P-" is displayed in the afternoon
- Click the rotary button again to determine the time, then the minute display flashes.
- Set the minute with the rotary button.
- Click the rotary button to confirm the value and exit the clock setting.
- Rotate button to start
- Press the rotary button for 3 seconds, the LCD will start.

### Shutdown

Press the rotary button for more than 3s at the initial interface to shut down. When the LCD switch is turned off, the heating process and any connected equipment are also automatically turned off. The parameters before shutdown are retained.

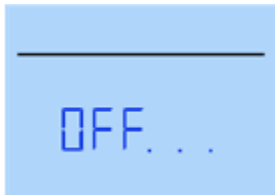

### Post-Purge Process (Cool-Down Cycle)

Since the heater has a higher residual heat after heating and a post-cleaning need, the fan typically runs for a few minutes for cooling.

### Heating Function Settings

The heating function setting should first set the fuel, and then select water heating or room heating or simultaneous heating, and finally set the fan speed. The default heating function settings is the fuel setting and the fan speed setting ECO.

#### Fuel Setting

- Rotate the button to select the fuel icon in the menu bar (3).
- Click on the selected icon.

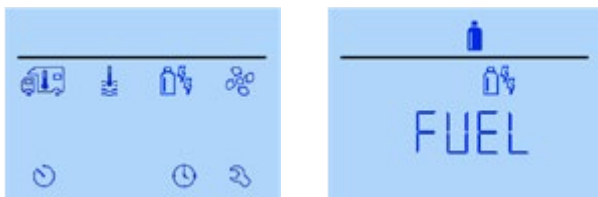

- Use the rotary button to select the desired fuel mode.
- Click the rotary button to confirm.

If the fuel type is not selected, once the heater starts to operate (room temperature, hot water icon is activated), the status bar shows the type of fuel selected during the previous heating process or the fuel type set at the factory.

Working Mode	Fuel Mode
GAS	LPG/Diesel/Gasoline
MIX 1	Electric 900W + GAS
MIX 2	Electric 1800W + GAS
EL 1	Electric 900W
EL 2	Electric 1800W

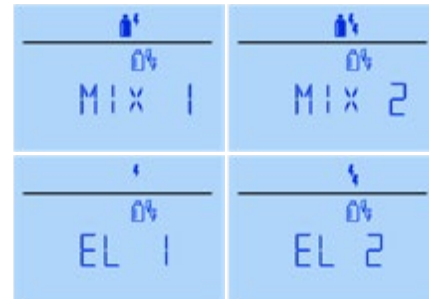

### Adjustment of Interior Temperature

- Click the rotary button to display the icon in the menu bar (3). Select the room temperature heating system with the rotary button according to the connected device.
- Confirm the selection by clicking the rotary button on the selected room temperature icon.
- Use the rotary button to select the desired temperature.
- Click the rotary button to confirm its value.

Temperature Display	°C / °F
Temperature Range	5-30°C / 41-86°F
Increments	1° C/F

This flame icon will be on when room temperature heating start, this icon will flash until the predetermined room temperature is reached.



### Adjustment of Water Heating

- Click the rotary button to display the icon in the menu bar.
- Use the rotary button to select the desired water temperature setting level.
- Click the rotary button to confirm

Working Mode	Energy Mode
OFF	Water heating is off - icon will not show
ECO	Water Temperature target of 40°C
HOT	Water Temperature target of 60°C
BOOST	Prioritizes water heating for 40 minutes or until the water temperature reaches 60°C



## Operating the LCD

 This icon will flash until the predetermined water temperature is reached.

In the "heating and hot water mode", the water temperature of 40°C can only be stored for a limited time (room heating priority).

### Adjustment of Fan Speed (when air heating is enabled)

- Click the rotary button to display the icon in the menu bar.
- Use the rotary button to select the desired fan speed setting level.
- Click the rotary button to confirm.

Working Mode	Energy Mode
OFF	Fan is off - icon will not show
VENT	Circulation ventilation. Can choose 10 levels of fan speed.
ECO	Low fan speed
LOW	Mid-speed
HIGH	High fan speed
BOOST	Fastest fan speed



### Adjustment of Vent Fan Speed

**NOTE:** Vent Fan is for air circulation without heating.

- Only available when air heating is not enabled
- Select OFF or VENT



- If VENT is selected, set the fan speed between 1-10.

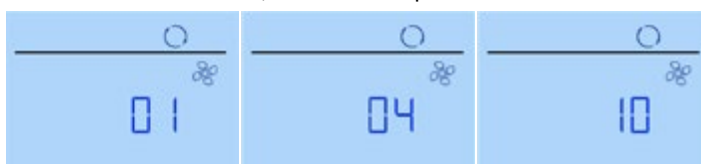

### Heating Start

After the setting is finished, press the return key or wait for 10s to enter the clock interface, and the heating starts. The clock and set temperature are displayed alternately.

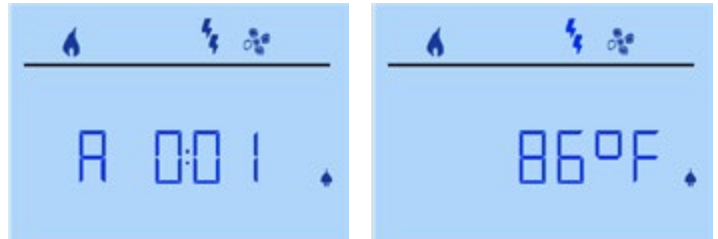

### Heating End

Press and hold the rotary button for 3 seconds to shut down.

### Timing Heating Settings

- Click the rotary button to display the icon in the menu bar (3).
- Click the rotary button to enter the timing settings.

 **WARNING**

**DANGER OF TOXIC EXHAUST FUMES**

Even if the vehicle is stopped, unmanned, the activated time switch will turn on the heater. Exhaust gases from heaters may be toxic in confined spaces such as garages, workshops, and repair shops.

If the vehicle is parked in a closed room:

- Turn off the fuel supply to the heater.
- Turn off the timer switch of the LCD switch.
- Turn off the heater on the LCD switch. Press and hold the rotary button for 3 seconds to turn off.

### Enter the Start-up Time

- Use the rotary button to set the start time.
- Click the rotary button to confirm and proceed to the next setting.

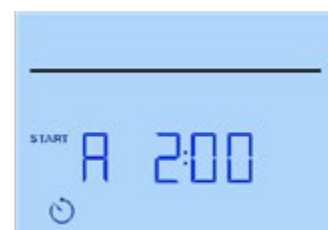

## Enter the End Time

- Use the rotary button to set the end time.
- Click the rotary button to confirm and proceed to the next setting.

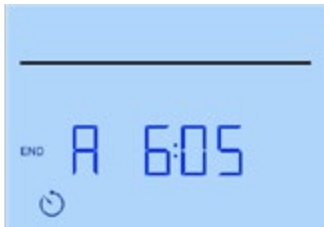

## Select Fan Speed Level

- Use the rotary button to set the desired fan speed
- Click the rotary button to confirm and proceed to the next setting.



## Set Room Temperature

- Use the rotary button to set the desired temperature
- Click the rotary button to confirm and proceed to the next setting.

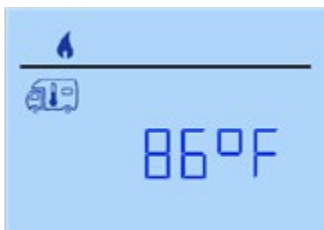

## Enable Timer

- Use the rotary button to select Enable Timing (ON). If OFF is selected, the timer is canceled, but the settings are saved.
- Click the rotary button to confirm and proceed to the next setting.



## Set Water Temperature

- Use the rotary button to set the desired temperature
- Click the rotary button to confirm and proceed to the next setting.

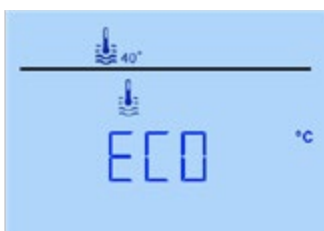

The time switch is only enabled once until it is disabled (turned off) or powered down. If the timer switch is programmed and enabled, the time switch icon is displayed in the status line (2). The timing icon flashes if the time switch is enabled and activated.

## Cancel Timer

- With the timing set, use the rotary button to select the timing setting. Click the rotary button to enter the settings.
- Use the rotary button to select the cancel timing (OFF). If you select ON, continue to use timing. Click the rotary button to confirm that the cancellation timing is valid. But the previous settings are still saved

## Fuel Mode Selection

- Use the rotary button to set the desired fuel mode
- Click the rotary button to confirm and proceed to the next setting.



## Parameter Settings

The content after the parameter setting is maintained after the power is turned off. Use the rotary button to select the "Settings" icon in the menu bar (4). Click the button to enter the settings.

## Voltage Inquiry

- Click the rotation button to display the voltage: 12.0V.

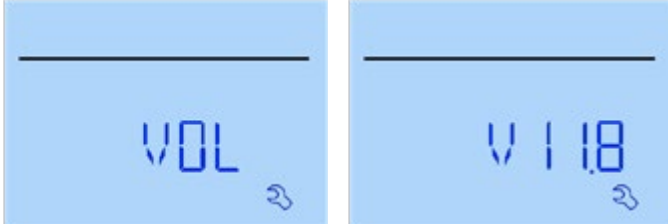

## Air Pressure and Temperature Inquiry

- Click the rotation button to select the ATMOS icon.
- Click the rotary button to enter the selection



- Use the rotary button to switch between atmospheric pressure and ambient temperature.

Atmospheric pressure: 99KPa Ambient temperature: 89°F

## Offset Setting

The external temperature sensor of the heater can be adjusted separately depending on the installation of the sensor. The offset setting can be in the range of -5°C to 5°C. The deviation is 1°C.

- Click the rotation button to select the OFFSET icon.
- Click the rotary button to enter the selection

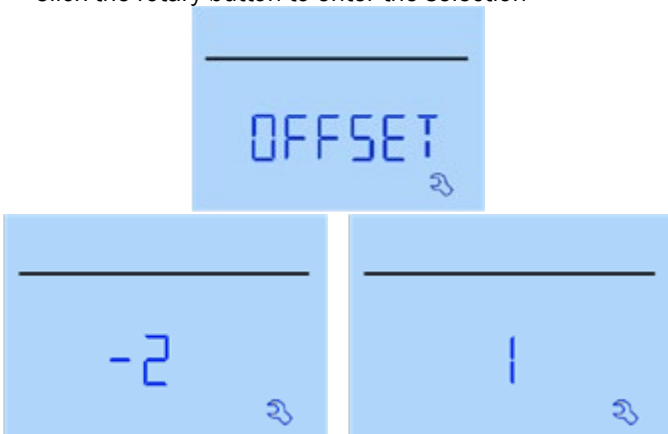

## Switching Temperature Units

Use the knob to switch between Celsius and Fahrenheit, then click to confirm

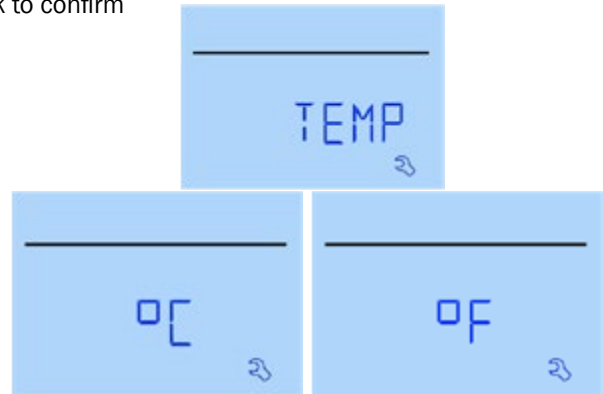

## LCD Backlight Adjustment

The LCD backlight has 10 levels of incremental adjustment.

Use the rotary button to select the BRIGHT icon and click the rotate button to enter the settings.

The brightness of the LCD changes as the rotary button rotates. After confirming by clicking the rotary button, return to the previous operation. The backlight brightness is set to 6 by default.

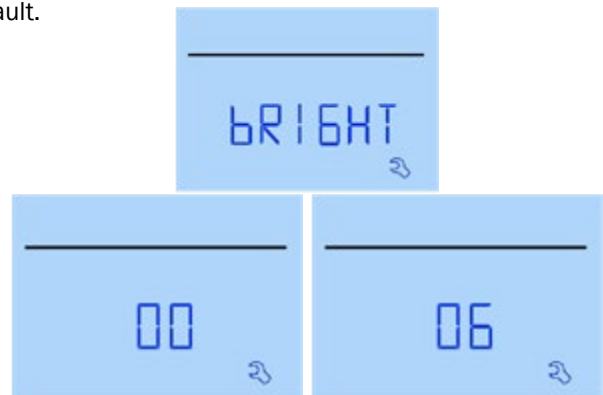

## Time Settings

Use the rotary button to select the time format setting icon and click the rotary button to enter the settings. Use the rotary button to select the 12h or 24h icon and click the rotary button to confirm. The default setting is 24h.

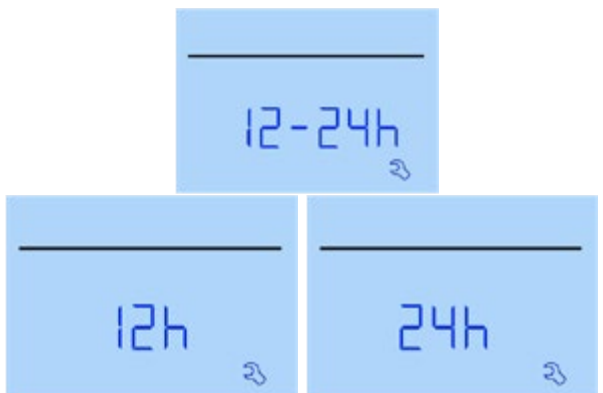

### Fast Pump Settings

Select pump oil icon GoOil with rotary button.

- Click on the rotary button to enter the fast pump oil. The default fast pump time is 90 seconds. The remaining time can be adjusted with a knob.
- Press the return key or stop the fast pump if the pump oil time exceeds the set value.

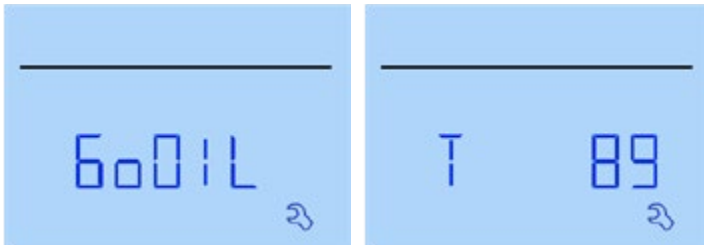

### Software Version Number

- Use the rotary button to select the INDEX icon and click the rotary button to enter the query item.
- Use the rotary button to view the information of the LCD switch or the information of the main controller.
- Click the rotary button or want to go back to return to the previous operation.

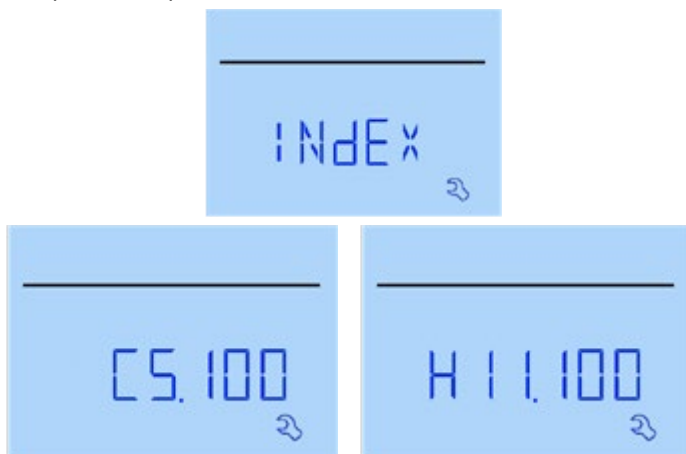

**C5.100** - LCD Version    **H11.10** - Master Controller Version

### Factory Settings

- The reset function resets the LCD switch to factory settings. All previous settings will be deleted. All devices used before RESET is installed and powered.
- Use the rotary button to select the RESET icon and click the rotary button to display the factory setting PR SET.
- After confirming, the initialization "INIT....." is displayed.

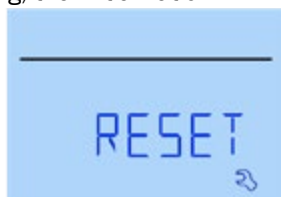

### Fault Display

- Use the rotary button to select the icon and click the rotary button to display the current warning code (for troubleshooting, please refer to the relevant heater instruction manual).
- There are faults in the fault that are automatically recovered and manually recovered after repair.
- An automatic recovery fault is a warning fault in which an operating parameter has exceeded a defined normal working range and reached an undefined state. In this case, the device will continue to run and the warning symbol (□) will be displayed in the menu bar (4) without warning code. After the fault is repaired, the warning symbol disappears automatically (it can also be manually restored), and the device continues to work according to the original settings. For example: warning fault code W 120 H.
- A manually recovered fault means that the fault code is displayed in the parameter setting 8 field (7) when the fault occurs. The cause of the fault can be determined and remedied by the help of the troubleshooting guide. The fault code disappears after a few seconds, and the warning disappears, and the warning symbol is displayed in the menu bar (4).
- Select Reheat after the fault is identified and resolved, first remove the fault code. Press the rotary button to display the fault code, then press the rotary button, the displayed fault code disappears and return to the initial time interface. Re-enter the heating parameters to initiate heating. If the fault is removed, the heating will be normal or the fault will occur again. The LCD switch will jump to the "Fault" menu again, the warning symbol will be displayed again, and the affected device will still be in the warning state. Since the fault has not been eliminated, if you want to return to the set level, press the back button (9). For example: fault code E 31 H. Shutdown and power off can also eliminate faults.

The fault code table and troubleshooting methods can be found in the tenth fault code table at the end of the manual.

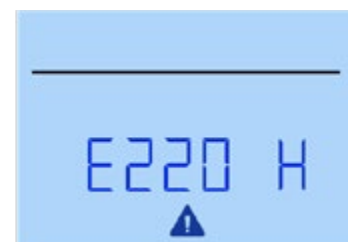



**NOTE:** The illustrations below are just samples for the layout of the Aqua-Hot heating system. Actual placement may vary on the individual design of the RV. For questions or assistance, contact us at 574-AIR-XCEL (574-247-9235).

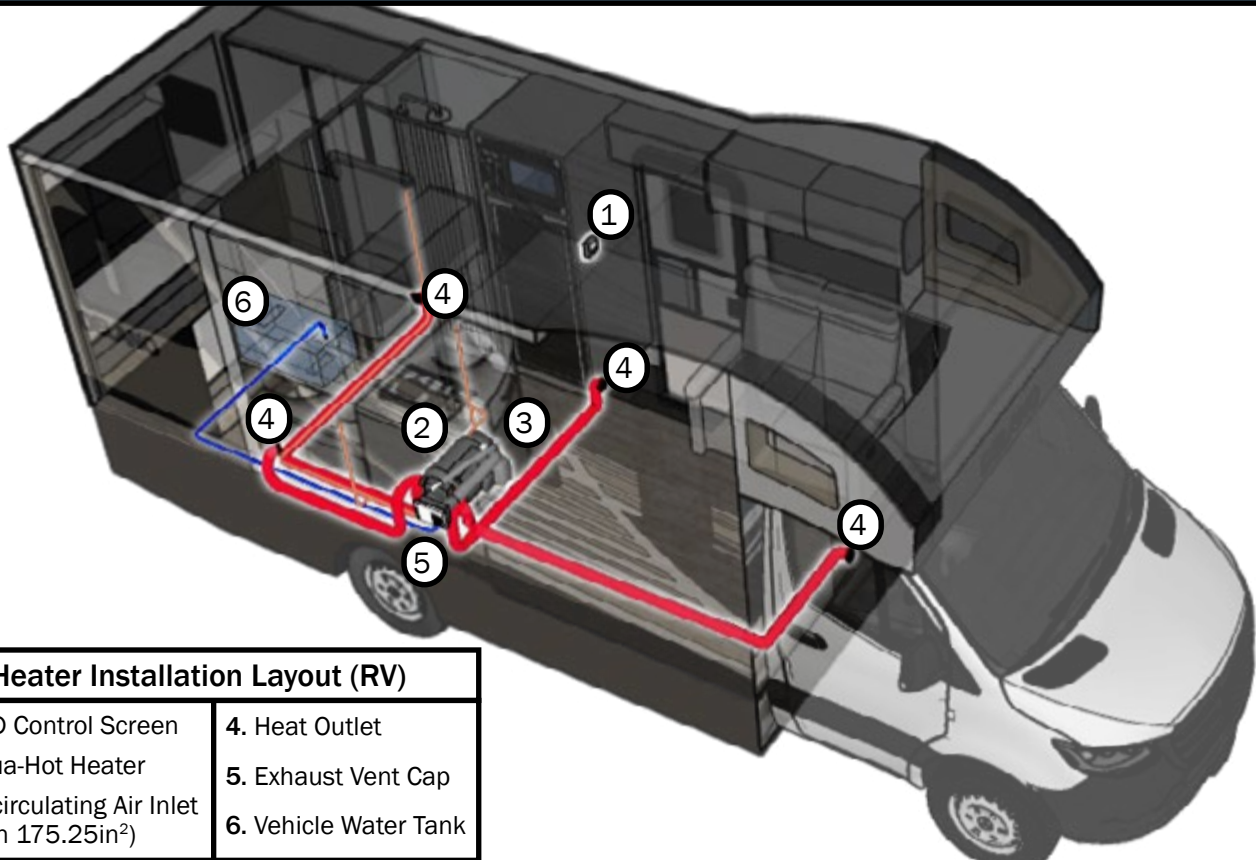

### Heater Installation Layout (RV)

- |  |                       |
|--|-----------------------|
| 1. LCD Control Screen                                      | 4. Heat Outlet        |
| 2. Aqua-Hot Heater   | 5. Exhaust Vent Cap   |
| 3. Recirculating Air Inlet<br>(min 175.25in <sup>2</sup> ) | 6. Vehicle Water Tank |

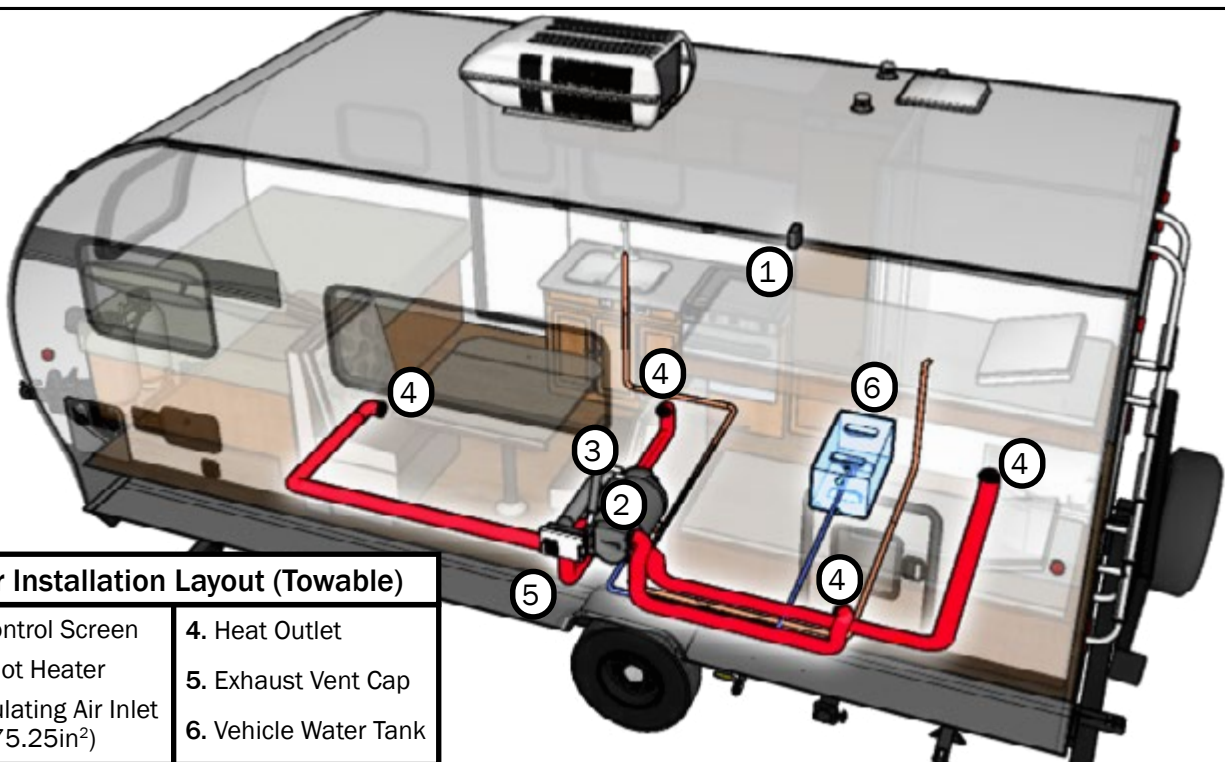

### Heater Installation Layout (Towable)

- |  |                       |
|--|-----------------------|
| 1. LCD Control Screen                                      | 4. Heat Outlet        |
| 2. Aqua-Hot Heater   | 5. Exhaust Vent Cap   |
| 3. Recirculating Air Inlet<br>(min 175.25in <sup>2</sup> ) | 6. Vehicle Water Tank |

Figure 7

## Maintenance & Storage

It is recommended to have the following service done once a year:

- Replace the fuel filter
- Check the air ducting, air intake and exhaust outlet for blockages or damage
- Check for damage or breaks in the fuel lines and wiring.

If the system has not been used for 2 months+, thoroughly flush all hot/cold water lines before use. It is recommended to run the heater at least once a month for 10-20 minutes to ensure optimum heater condition.

The water tanks must be cleaned regularly, minimum of twice a year. When the RV is driving or in storage, the temperature range should not fall below -40°F or rise above +185°F to prevent damage to the electronic components.

It is necessary to take precautions during any user maintenance

If the vehicle is parked in a closed room:

- Turn off the fuel supply to the heater.
- Turn off the timer switch of the LCD switch.
- Turn off the heater on the LCD switch. Press and hold the rotary button for 3 seconds to turn off (see below).



Figure 8

Rotary Button /  
Turn Knob  
Press and hold for 3  
seconds to turn off



# WARNING

**If the information in this manual is not followed exactly, a fire or explosion may result, causing property damage, personal injury or death.**

### WHAT TO DO IF YOU SMELL GAS

- Evacuate all persons from the vehicle.
- Shut off the gas supply at the gas container or source.
- Do not touch any electrical switch or use any phone or radio in the vehicle.
- Do not start the vehicle's engine or electric generator.
- Contact the nearest gas supplier or qualified service technician for repairs.
- If you cannot reach a gas supplier or qualified service technician, contact the nearest fire department.
- Do NOT run the first operation until it has been confirmed there are no gas leaks.
- Do not turn on the gas supply until the gas leak(s) have been repaired.
- Installation and service must be performed by a qualified installer, service agency, or gas supplier.



# WARNING

**If the information in this manual is not followed exactly, a fire or explosion may result, causing property damage, personal injury or death.**



# WARNING

**The heating system can produce dangerous CO gas when the propane system is operating if not properly installed or operated. Read all safety instructions before install or use.**

## Winterization

To avoid freeze damage to the system, the heater must be drained through the drain valve completely. If water is left in the system in below freezing temperatures, it can cause severe damage to the system that is not covered under warranty.

- Turn off power supply and open hot water faucets in the RV.
- Place a container under the drain valve to catch the water.
- Open the drain valve and allow the water to drain out completely.

It is recommended to winterize if the RV will be stored for a long time or the system will not be used, and it is below freezing.



# WARNING

**Not winterizing the Aqua-Hot when freezing temperatures are present will result in serious damage to the Aqua-Hot domestic water heating system. The warranty does not cover freeze damage.**

## Disinfecting the Domestic Water System

# NOTICE

The Aqua-Hot Heating components are not compatible to prolonged exposure to sodium hypochlorite (bleach or liquid bleach). Using products containing bleach, including water refreshers, may cause corrosion of the domestic water lines, resulting in a catastrophic failure of the Aqua-Hot system by creating leaks that cannot be repaired. This damage is not covered by the Aqua-Hot warranty.

If disinfecting the hot water system, be sure to follow any current national regulations or any other applicable local standards for Water Systems.



# DANGER

**Water temperature over 125° F can cause severe burns instantly, or death from scalds. Water temperature coming from the heater will be at 160° F. Feel water before bathing or showering! Temperature limiting valves are available.**

Domestic Hot Water Installation Layout	
<ol style="list-style-type: none"> <li>1. Pressure Relief Valve</li> <li>2. Cold Water Inlet</li> <li>3. Hot Water Outlet</li> <li>4. Drain Valve</li> <li>5. Tempering Valve</li> <li>6. Non-Return Check Valve</li> </ol>	<ol style="list-style-type: none"> <li>7. Domestic Water Lines</li> <li>8. Pressure Regulator</li> <li>9. City Water Hook-Up</li> <li>10. Water Tank Connection</li> <li>11. Water Pump</li> <li>12. Fresh Water Tank</li> </ol>

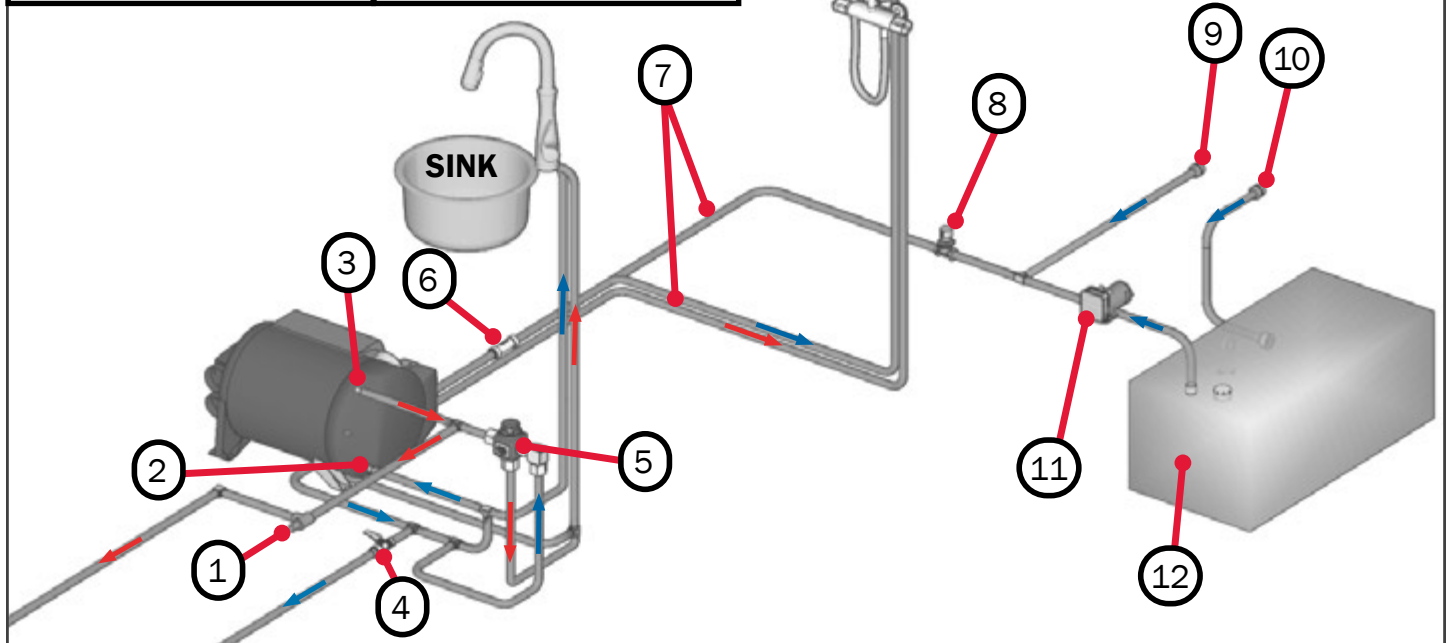

**NOTE:** This diagram is just a sample for the layout of the hot water system. Actual placement may vary on the individual design of the RV.

Figure 9

## Troubleshooting

- Ensure that the system is supplied with electrical power and there are no blown fuses.
- Ensure that there is at least ¼ tank of propane in the gas supply.
- Make sure all the electrical and plumbing connections are connected and secure.
- Ensure there are no faults on the LCD. If there are, determine the fault and remedy. Refer to the table below for the fault code.

Fault Codes		
Error Code	Fault Name	Remedy
10	Over-voltage	Check vehicle power supply
11	Low Voltage	Check vehicle power supply
21	Warm air outlet temperature sensor disconnect	Check temperature sensor connections
22	Warm air outlet temperature sensor short circuit	Check temperature sensor wiring
23	Water temperature sensor disconnect	Check temperature sensor connections
24	Water Temperature sensor short circuit	Check temperature sensor wiring
25	External temperature sensor disconnect	Check temperature sensor connections
26	External Temperature sensor short circuit	Check temperature sensor wiring
27	Combustion support temperature sensor disconnect	Check temperature sensor connections
28	Combustion support temperature sensor disconnect	Check temperature sensor wiring
31	Combustion Failure	<ul style="list-style-type: none"> <li>• Check gas supply system</li> <li>• Check combustion inlet and outlet are blocked</li> <li>• Check ignition coil, electrode</li> <li>• Flame sensor</li> </ul>
32	Combustion failure	<ul style="list-style-type: none"> <li>• Check gas supply system</li> <li>• Check combustion inlet and outlet are blocked</li> <li>• Check Flame sensor</li> </ul>
33	Flame sensor fault	<ul style="list-style-type: none"> <li>• Check flame sensor lead wire</li> <li>• Check flame sensor</li> </ul>
41	Warm air outlet overheats	Check air outlet for blockages
42	Warm air overheat switch protection	<ul style="list-style-type: none"> <li>• Check whether air outlet is blocked</li> <li>• Check warm air overheat switch</li> </ul>

Error Code	Fault Name	Remedy
43	Water overheat	<ul style="list-style-type: none"> <li>• Check water tank levels</li> <li>• Check sensor wiring/connections</li> <li>• Check air outlet for blockages</li> </ul>
44	Warm air overheat switch protection	<ul style="list-style-type: none"> <li>• Check air outlet for blockages</li> <li>• Check warm air overheat switch</li> </ul>
45	Overheat fault	<ul style="list-style-type: none"> <li>• Check air outlet for blockages</li> <li>• Check water temperature sensor</li> <li>• Check warm air sensor</li> </ul>
51	Communication fault	Check interconnecting cable
61	Fuel Pump Break	<ul style="list-style-type: none"> <li>• Check fuel pump lead for damage</li> <li>• Check fuel pump wire connections</li> <li>• Replace fuel pump</li> <li>• Replace controller</li> </ul>
62	Fuel pump short circuit	<ul style="list-style-type: none"> <li>• Check fuel pump lead for damage</li> <li>• Check fuel pump wire connections</li> <li>• Replace fuel pump</li> <li>• Replace controller</li> </ul>
63	Electric element circuit broken	<ul style="list-style-type: none"> <li>• Check power supply voltage</li> <li>• Check resistance at room temp (0.2/12V)</li> <li>• Clean any carbon build-up</li> <li>• Replace controller</li> </ul>
65	No power to electric element	Replace controller
81	Combustion fan disconnect	Check combustion air blower
82	Combustion blower boot failure	<ul style="list-style-type: none"> <li>• Check blower motor lead wire</li> <li>• Check combustion air blower</li> </ul>
83	Combustion blower speed too low	Check combustion air blower motor
84	Warm air blower motor disconnect	Check warm air blower motor
85	Warm air blower motor boot failure	<ul style="list-style-type: none"> <li>• Check blower motor lead wire</li> <li>• Check warm air blower motor</li> </ul>
86	Warm air blower speed too low	Check warm air blower motor
110	Window alarm	Check window switch cable
120	Low Voltage Fault	Check power supply and connections
220	220V Disconnect	Check AC 220V/110V power supply

### Heater Lock-out Reset Procedure

To reset the heater from a lock-out, simply turn off the heater and disconnect power supply to the heater, wait for 20 seconds, then reconnect power supply and restart the system.

<b>DATE</b>	<b>SERVICE PERFORMED</b>	<b>SERVICE CENTER</b>

<b>DATE</b>	<b>SERVICE PERFORMED</b>	<b>SERVICE CENTER</b>





## **2-YEAR LIMITED WARRANTY AQUA-HOT® HYDRONIC HEATING SYSTEM**

Aqua-Hot Heating Systems Inc. warrants the Aqua-Hot Heater to be free from defects in material and workmanship under normal use and service for a period of two years on both parts and labor commencing upon the original date of registration of the vehicle. Replacement parts are warranted for the remainder of the Heater's standard warranty coverage or for six months, whichever is greater. The intent of this warranty is to protect the heater's end-user from such defects, which would occur in the manufacturing of the product. Thus, problems due to improper specifications, improper installations, improper use, the use of accessory parts or parts not authorized by Aqua-Hot Heating Systems Inc., repair by unauthorized persons, and damage or abuse of the heater are specially excluded from warranty coverage.

For additional information, or to obtain a warranty repair authorization, please contact the Aqua-Hot Heating Systems Warranty Administrator at 574-AIR-XCEL (574-247-9235) (7:00 AM to 4:00 PM Mountain Standard Time) or visit [www.aquahot.com](http://www.aquahot.com).

### **My Comfort Zones are On-Board**

Vehicle:

### **Purchased From:**

Dealer Information:

Name:

Location:

Phone Number:

### **Heating System:**

Serial Number:



Scan the QR code on the right with your mobile device to take you to the website to register your Aqua-Hot product.

Operation Manual

# GEN1<sub>SERIES</sub>



GEN-1 LPG



Aqua-Hot Heating Systems, LLC  
7501 Miller Drive, Frederick, CO 80504

Visit us online at [www.aquahot.com](http://www.aquahot.com)  
Call us at 574-AIR-XCEL (574-247-9235)

©2023 Aqua-Hot Heating Systems, LLC. Printed in the USA