



TECEdrainprofile shower profile

Article number: 670900

Length: 900 mm

Width: 55 mm

Surface: brushed

DU 1: 1 pc.

Description:

Shower profile for shower drainage, for installation in tile adhesive above the screed and seal.

Consisting of:

- Shower profile that can be cut to length made of stainless steel, with internal incline for improved water drainage and self-cleaning effect, material 1.4301 (304)
- Shower profile can be shortened to ≥ 500 mm
- Profile lid made of stainless steel, with "Push Function" for removal by hand, material 1.4301 (304), durable to load class K3 - maximum test load 300 kg
- Connection piece for connection with a TECEdrainprofile drain
- Grip elements for easy installation and solid connection with the tile adhesive
- For floors from 8-25 mm (incl. adhesive bed)
- For flush to the wall installation for wall coverings from 10 mm (incl. adhesive bed)
- For installation at the wall (flush to the wall) or at any specific distance from the wall

Sales data:

Product name: TECEdrainprofile shower profile, 900 mm, brushed stainless steel
 Commodity group: 608
 Product group: 3006080010

Dimensional drawings:

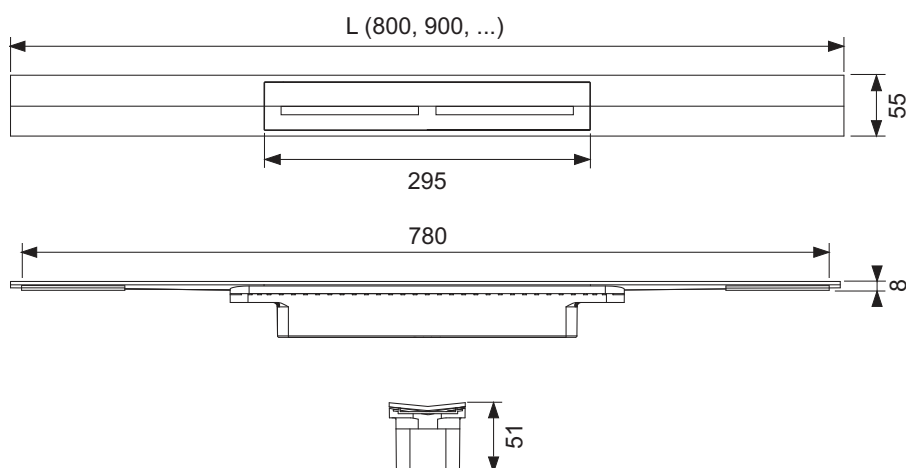

Spare parts:

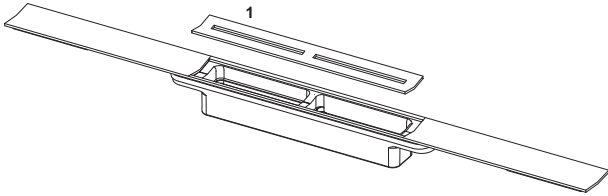

- 1 675000 Profiled cover in stainless steel, brushed