

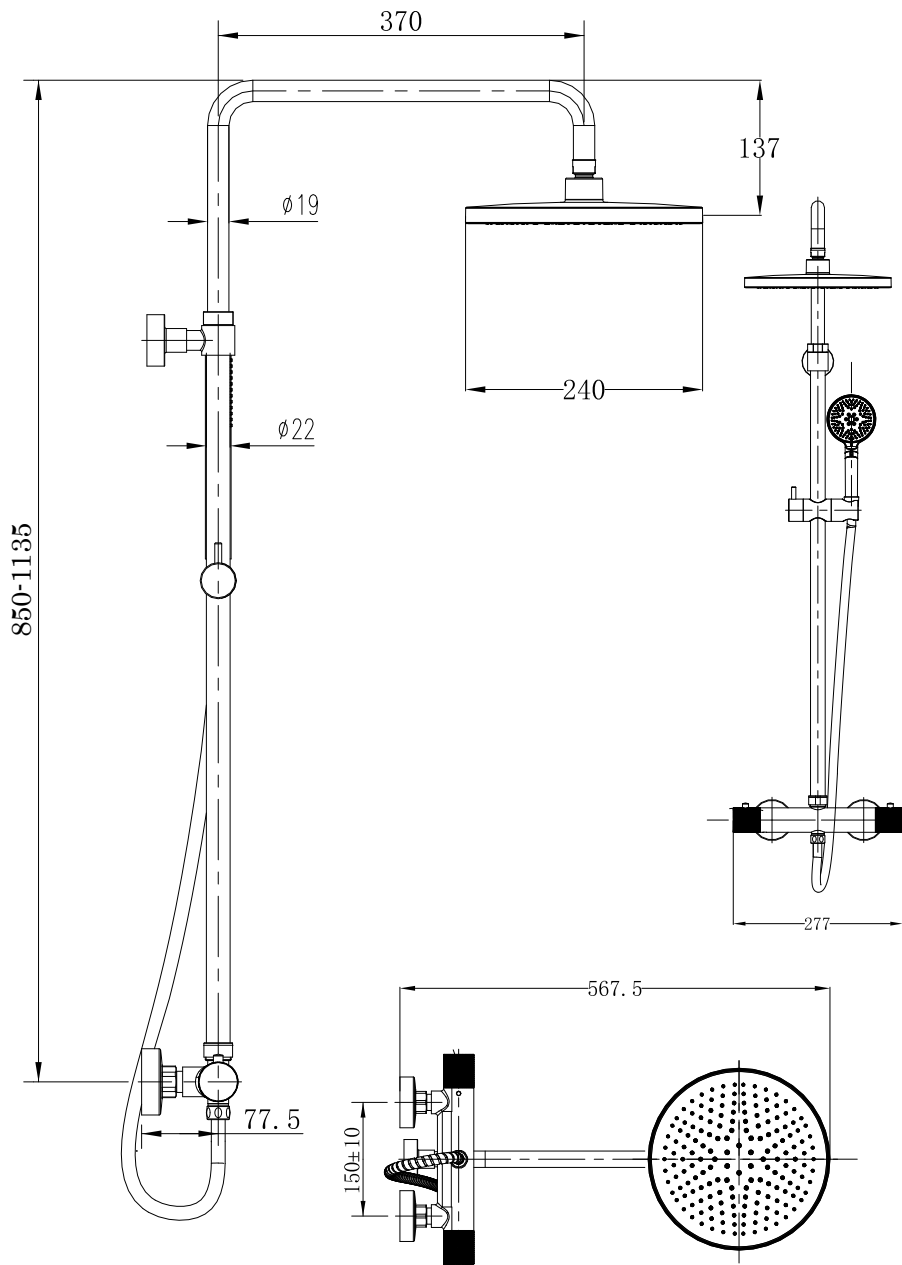

SATSSTK
SATSSTKC
SATSSTKE



SATSSTK



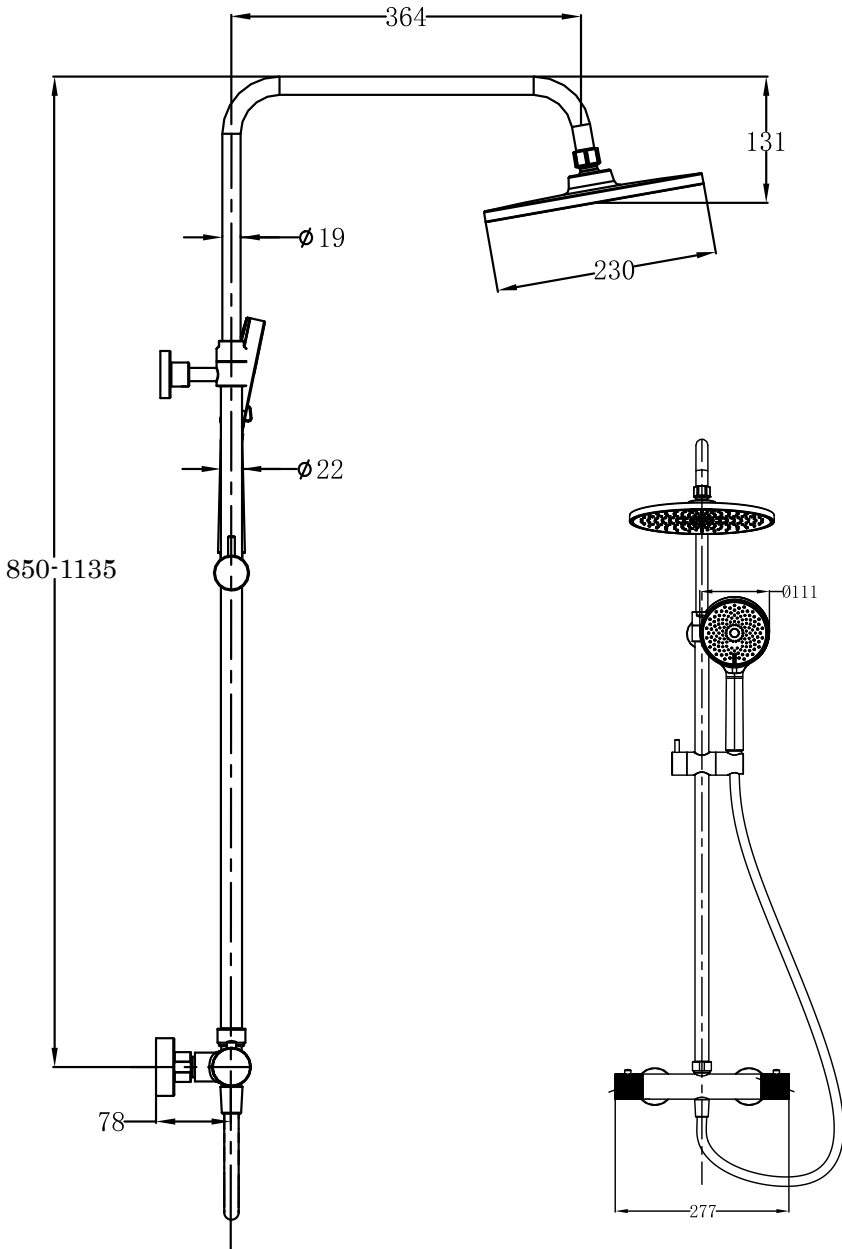

SATSSTKE

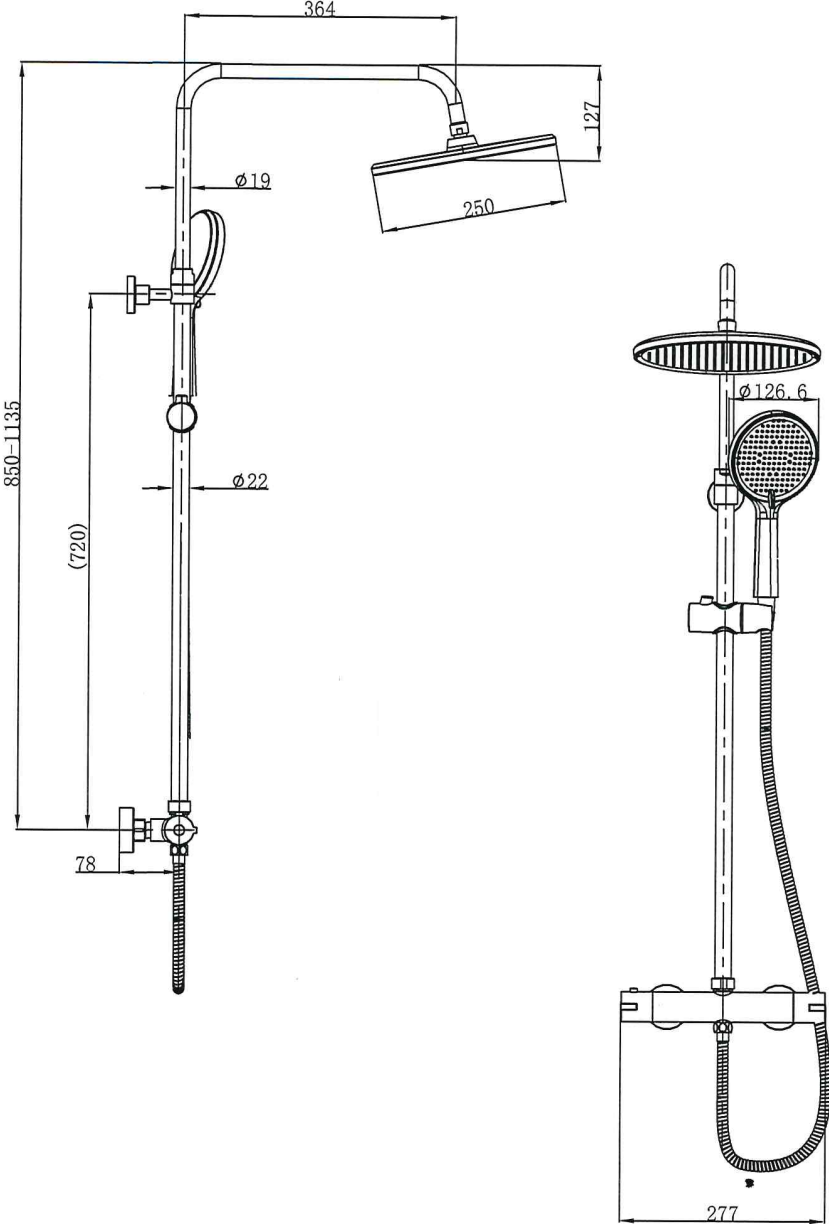

SATSSTK SATSSTKC SATSSTKE

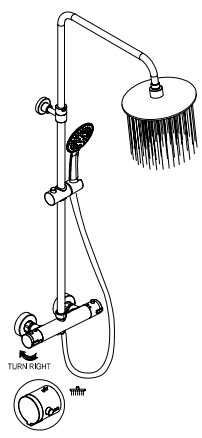
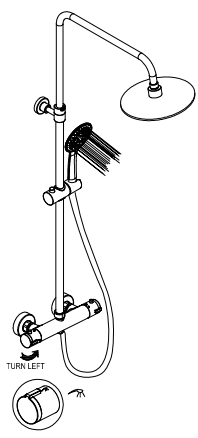
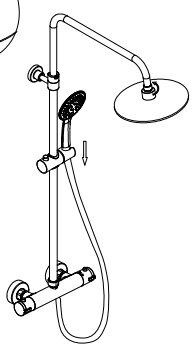
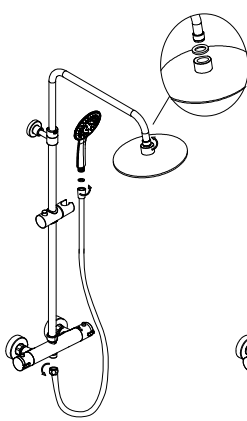
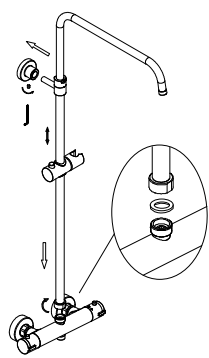
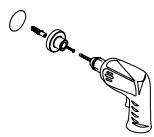
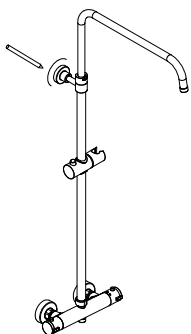
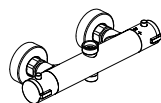
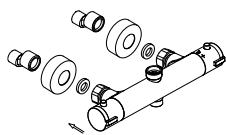
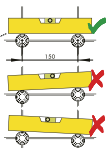
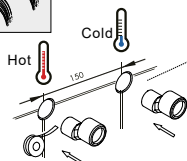

SATSSTK SATSSTKC

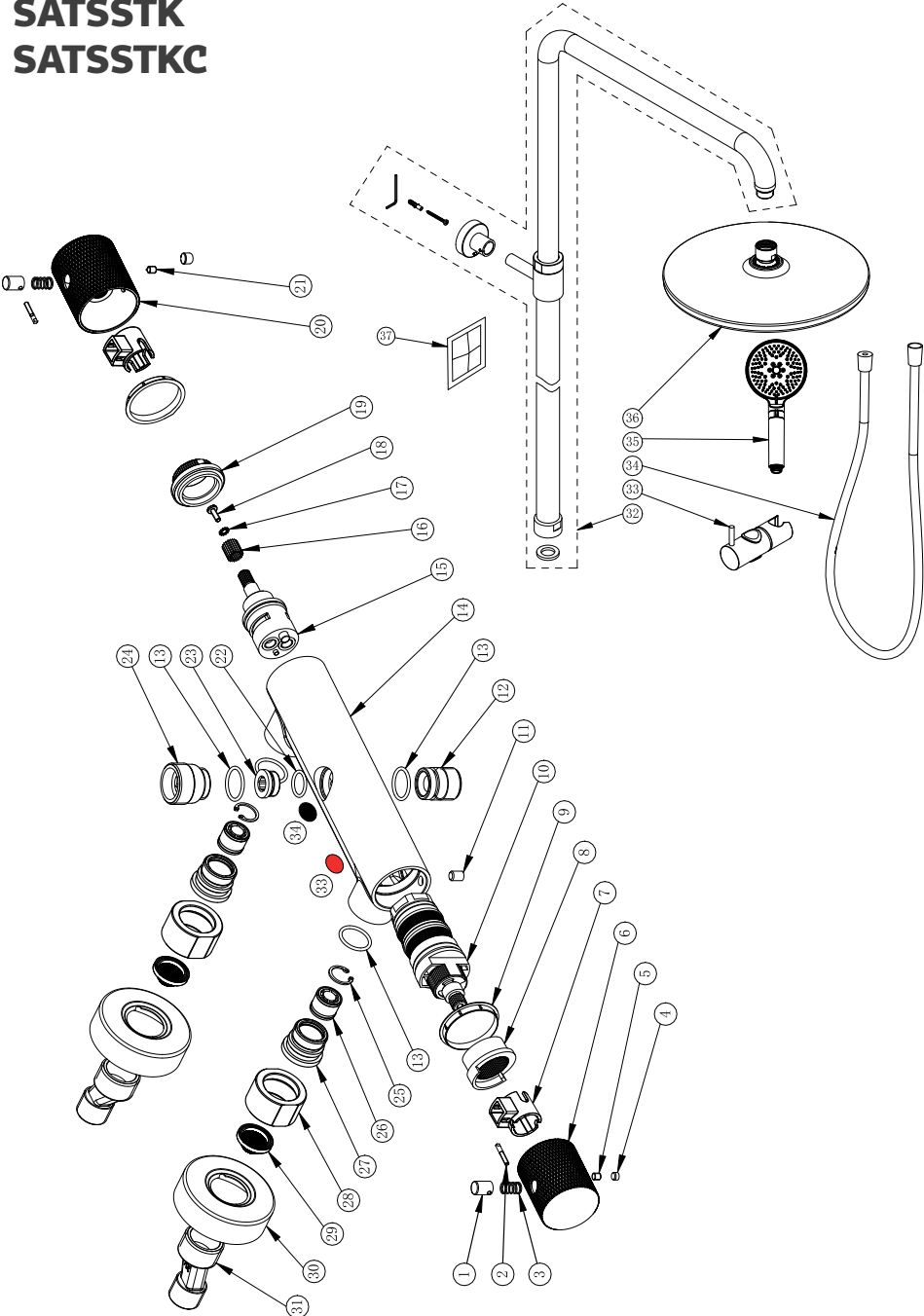

SATSSTKE

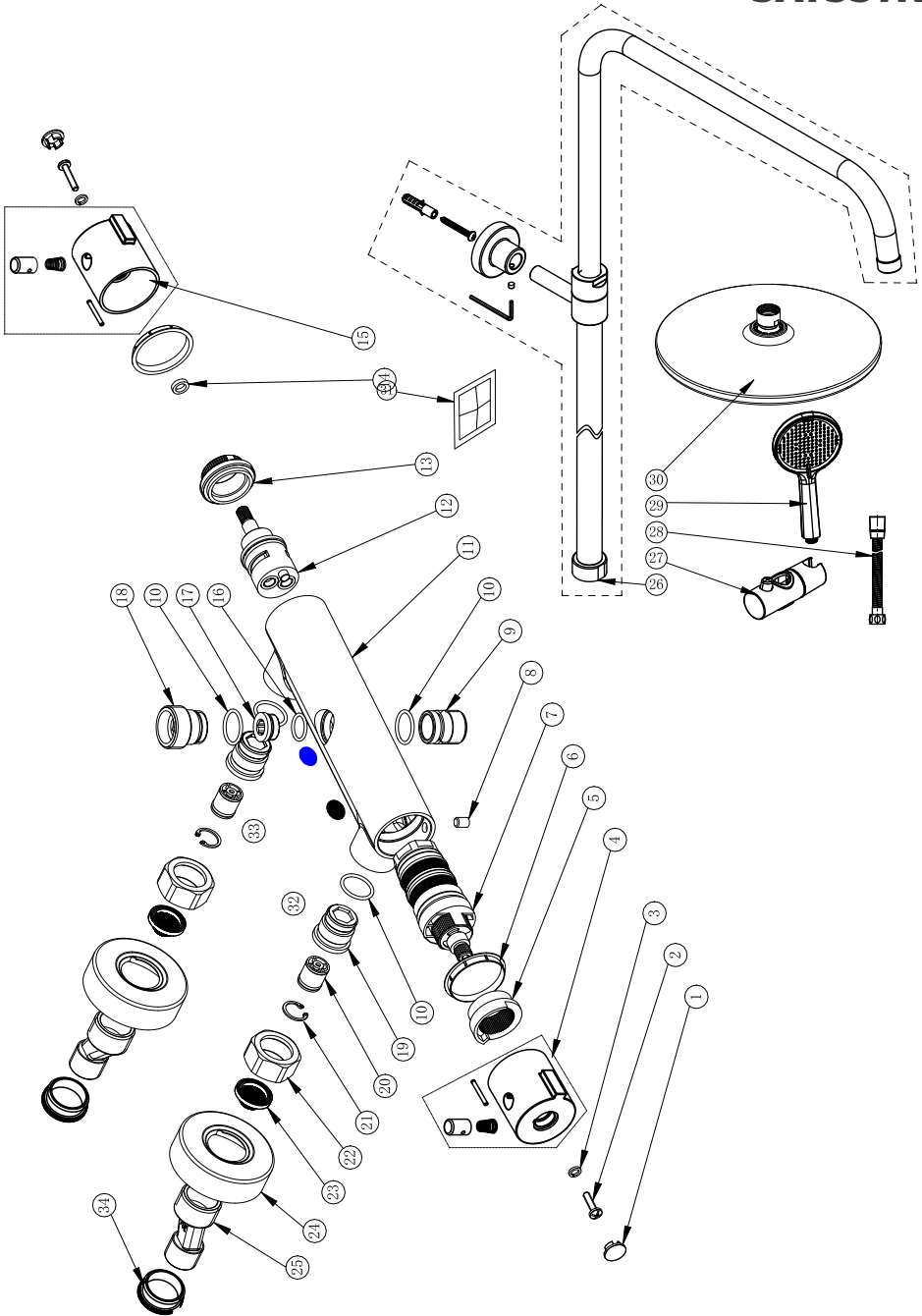

SATSSTK

1-11	NDSSTKTERMSET
12-13	NDSSTK12
15	NDSSTKPREP
16-21	NDSSTK20
13, 22-24	NDSSTK24
28	NDSIKOBSTPREVLMAT
30-31	NDSIKOBSTROZETASET
33	NDSSTKJEZDEC
34	SATHADICE
35	SATBSRS36
36	SATBSHS36

SATSSTKC

1-11	NDSSTKTERMSETC
12-13	NDSSTK12C
15	NDSSTKPREP
16-21	NDSSTK20C
13, 22-24	NDSSTK24C
28	NDSIKOBSTPREVLMATC
30-31	NDSIKOBSTROZETASETC
33	NDSSTKCJEZDEC
34	SATBSHPBW
35	SATBSRS37C
36	SATBSHS37C

SATSSTKE

1-7	NDSSTKETERMSET
12	NDSSTKEPREP
14-15	NDSSTKERUK1
22	NDSIKOBSTPREVLMAT
24-25	NDSIKOBSTROZETASET
26	NDSSTKETYC
27	NDSIKOBSSTJEZDEC
28	SIKOBESHK150
29	SATBSRS40
30	SATBSHS40

SATSSTK SATSSTKC SATSSTKE

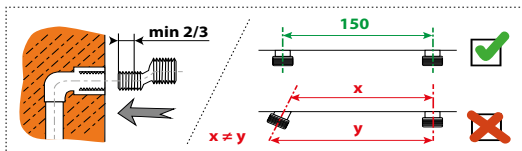
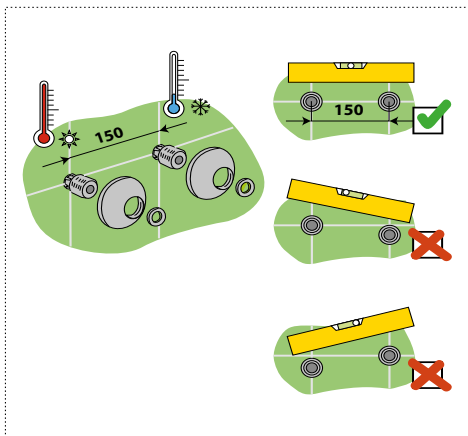
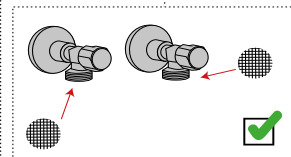
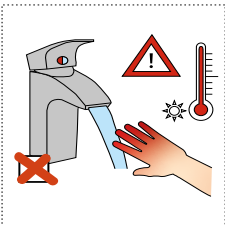
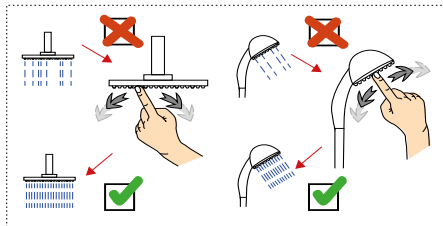
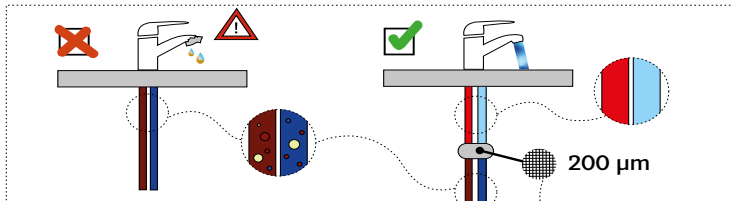
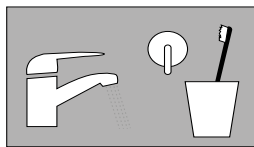
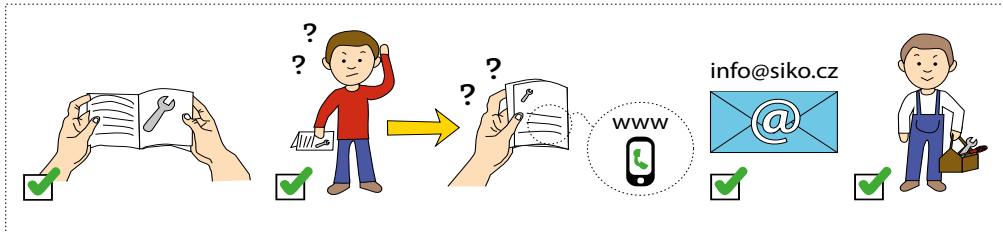

	P	P bar	min 1,0	max 10,0	5
	T	°C	max 80°	65°	40°

SATSSTK SATSSTKC SATSSTKE

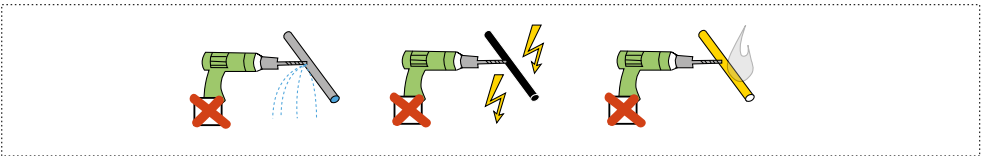
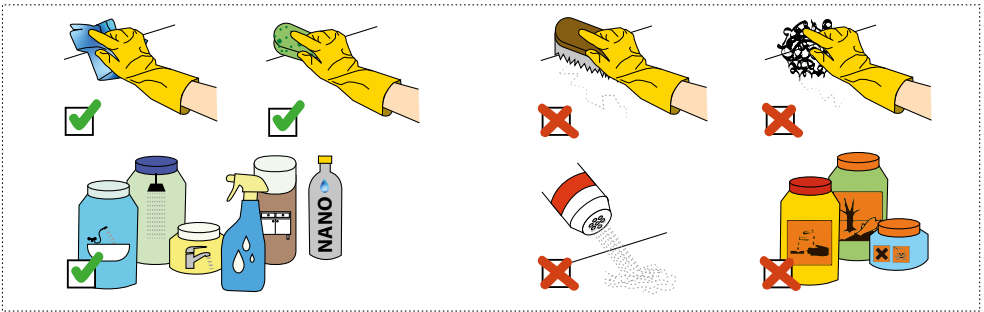
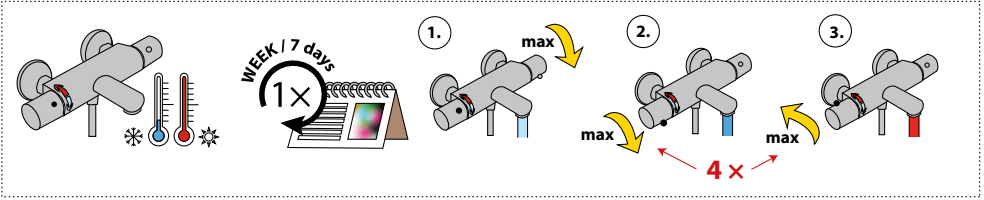

SAT® is registered trademark of



**Swiss
Aqua
Technologies**

Swiss Aqua Technologies AG
Gewerbstrasse 9, 6330 Cham, Switzerland
www.swatec.ch
Imported by SIKO KOUPELNY a.s.
Made in P.R.C.