

INSTALLATION AND OPERATION INSTRUCTION MANUAL FOR WINDOW-TYPE AIR CONDITIONER



■ MODEL

CLYW-35C1A-L09AC
CLYW-41C1A-L09AC

Introduction

Please read the entire manual and operation instructions before installation. If you are unsure how to properly install the unit, please contact a certified professional. This instruction manual is a general-purpose version for varied models of the window air conditioner. The appearance of the unit that you purchase might be slightly different from the ones described in the manual, but it _does not affect the proper operation and usage. Please carefully read the sections that correspond to the specific model you purchased. Keep the manual in a safe place for you to reference at a later time.

Addition to the user manual:

This appliance is not intended for use by young children or invalids without supervision.

Table of Contents

Safety Information	1
Specifications and Operating Instructions	3
Remote Control	5
Maintenance	7
Troubleshooting	8
Installation	10
Warranty	15

SAFETY INSTRUCTIONS

Read this Manual carefully before using the air conditioner to ensure proper operation of the units.

INSTALLATION SAFETY

- If you are unsure how to properly install this unit, please contact a certified professional.

Do not install the unit at a place where there might be leakage of flammable gases.



In the case that flammable gases are present around the unit, it might result in overheating, malfunction, fire hazards, property damage, and/or other accidents.

Connect to a properly grounded 3-prong outlet **ONLY**.

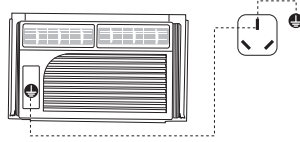

Do not connect to extension cords, surge protectors, or timers. Improper grounding will lead to possible electric shock or other hazards.

OPERATION SAFETY

Do not turn off the air conditioner by pulling the power cord directly from the outlet.



It might result in electric shock, fire hazard or other accidents.

Do not use extension cords or power strips, with this unit.



Do not press, stretch, damage, heat or modify the power cord.



In the case that the power cable is damaged or that a replacement for the power cable is needed due to some other reasons, please contact Lifesmart Technical Support.

Do not operate the air conditioner with wet hands.



This might lead to electric shock or other hazards.

Make sure that there is no dust on the plug before you plug the power cord in, and make sure the plug is well into the socket.

If there is dust on the plug or the item is not plugged in properly, it might lead to electric shock, fire hazards, or other accidents.



Do not use the fuse with improper capacity or other metal wires.

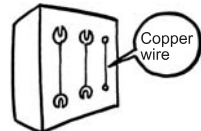

Improper use of the metal wires or copper wires for fuse may result in faulty performance by the machine or a fire hazard.

SAFETY INSTRUCTIONS

Avoid direct sunlight to the AC unit. During the cooling operation: Window curtains or louver blinds can be used to shade off the sunlight.



Try to reduce the generation of heat in the room during cooling operations. Place the heating source outside of the room. If possible, do not use burning appliances in the air-conditioned room.



It might lead to the unnecessary burning of these appliances

If the air conditioner and other burning appliances must be used in the same room, allow for proper ventilation.



Insufficient ventilation can be hazardous to the air conditioner.

Do not place or spray items such as insecticides, paints, or other flammable spraying agents near or against the air conditioner.



It might result in fire hazards.

Do not insert sticks or other hard objects into the air intake or outlet vents



The high-speed rotation of the fan blades may cause accidents.

Do not wash the air conditioner with water.



It may cause electric shock or other accidents.

Do not use the following articles:

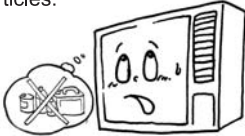

Warm water (above 40 °C or 104°F) Warm water might cause deformation or fading of colors of the air conditioner. Gasoline, paint diluting agents, benzene, abrasives, etc. may cause deformation or scratches to the air conditioner.

Do not allow cold air to directly blow on your body for extended periods of time.



This may lead to body discomfort or harm your health

If the air conditioner is not in use for a long period of time, please power off and unplug the unit.



INSTRUCTIONS FOR REMOVAL AND REPAIRS

- For questions, please contact Technical Support at 1-800-752-5242.
- In the occurrence of any abnormality such as a burning smell, please stop the operation of the unit, disconnect the power and contact lifesmart technical support.

SPECIFICATIONS AND OPERATION INSTRUCTIONS

FEATURES

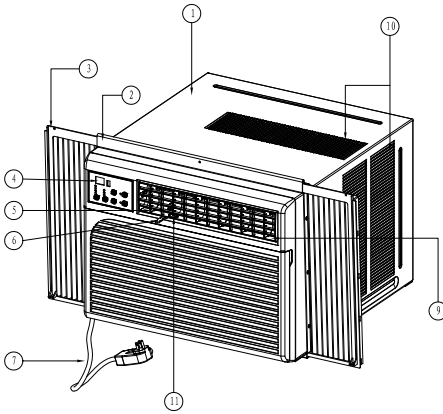

- 1 Cabinet
- 2 Upper guide
- 3 Curtain(window filler)
- 4 Operation panel
- 5 Left/right air direction fin
- 6 Fresh air switch(optional,some models are not supplied with this)
- 7 Power cord
- 8 Front grille
- 9 Up/down air direction flap
- 10 Air inlet
- 11 Left/right air direction control tab

Features and appearance will vary,all the figures provide a demonstration to introduce the funtion. The followings are two types of operation panels, Please check to refer the instructions for the identical operation panel of your air-conditioner.

OPERATION PANEL 1

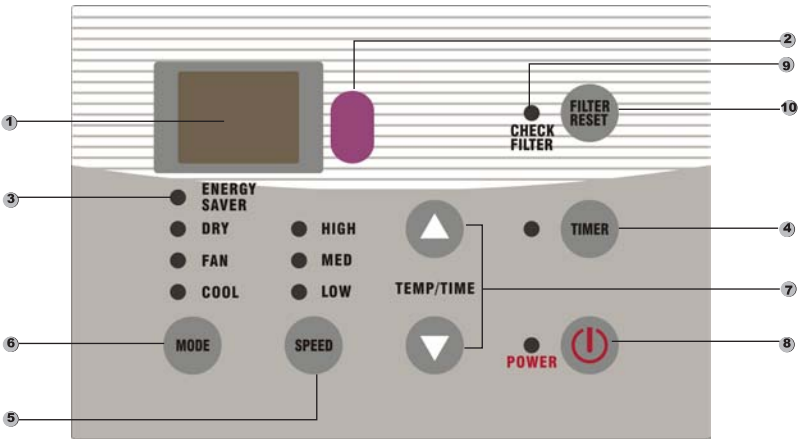

SPECIFICATIONS AND OPERATION INSTRUCTIONS

1 DIGITAL DISPLAYER

In usual operation, In FAN mode, It indicates room temperature; In COOL or DRY mode, It indicates setting temperature; In timer operation, when pressing the timer button, it indicates timer time, if the time has not been adjusted after 5 seconds, it indicates temperature again; If ROOM TEMP SENSOR failure, It indicates temperature at 25°C(77°F).

2 REMOTE CONTROLLER SIGNAL RECEIVER

3 ENERGY SAVER

Fan operation shall occur in conjunction with compressor operation, the closing of Fan delay 1 min after compressor off, when compressor is off, fan stops for 10 minutes to open 20 seconds period run until compressor is on; other function same with the cooling function

4 TIMER button

If unit is running, Press this button will enter Switch-OFF mode; If unit is off (in standby mode), Press this button will enter Switch-ON mode. Press this button again will cancel the timer operation. Used together with ▲ or ▼ button to set the timer time.

5 SPEED button

Press this button to set air rate you want: HIGH, MED, LOW.

6 MODE button

Press this button, it advances the operation mode as follows: ENERGY SAVER-DRY-FAN (heating for cooling and heating model)-COOL.

7 TEMP/TIME button

In usual, press this button to adjust setting temperature within a range of 16°C(61°F) to 32°C(90°F). In timer time setting state (press timer button to enter and "hr" indicator on right bottom of the digital displayer will be flashing), press ▲ or ▼ button to set the timer time within 1-24 hours. Regard less of the display status, press the "▲" and "▼" button at the same time, to switch celsius/Fahrenheit display.

8 ON/OFF button

To turn the air conditioner ON, press the button and the power indicator will light. To turn the air conditioner OFF, press the button again.

9 CHECK FILTER

Filter cleaning machine works for 250 hours, "CHECK FILTER" LED light, reminds needing cleaning the filter.

10 FILTER RESET button

Press "FILTER RESET" button, and retiming, "CHECK FILTER" LED lights will go out.

REMOTE CONTROL

REMOTE CONTROL

Note: Only some model air conditioners are supplied with a remote control. There are two types of remote controls, Please check to refer the instructions for the identical remote control of your air-conditioner.

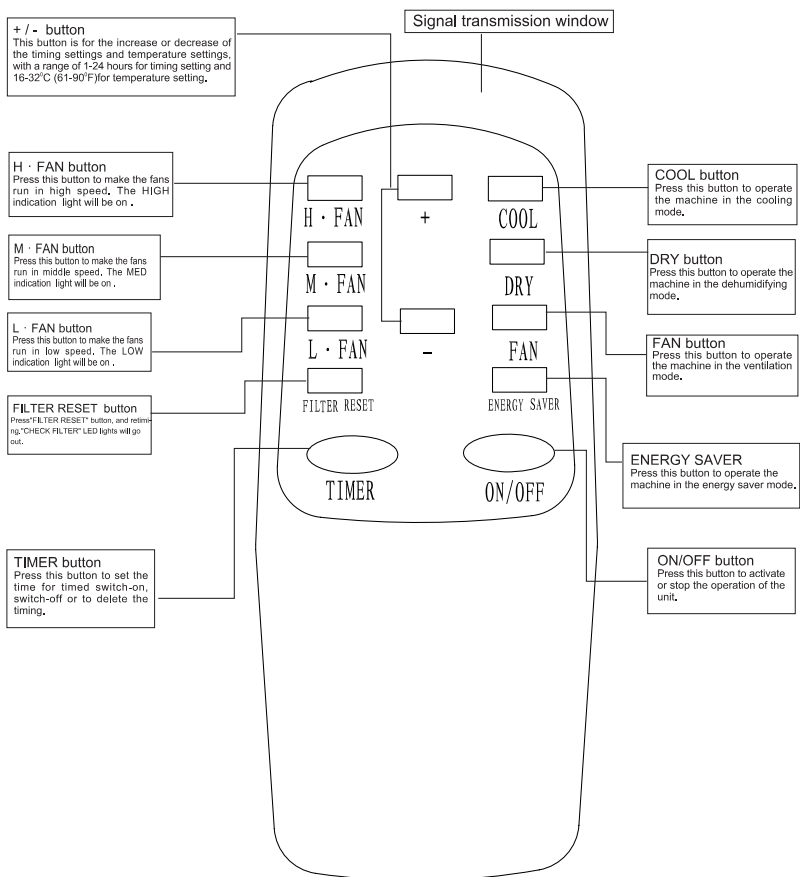

REMOTE CONTROL OPERATION

METHOD OF TRANSMISSION

- Point the remote controller at the air conditioner as shown in the figure and press the button on the controller. The instruction signal will be transmitted to the air conditioner.
- Upon receiving the signal from the remote controller, the air conditioner unit will utter a "dee-" sound for acknowledgment.

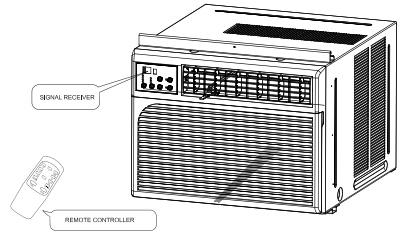

REMOTE SAFETY

- Do not expose the remote to high temperatures or exposure to direct sunlight.
- Do not drop the remote control, this might cause damage.
- Do not obstruct the signal receiving window on the air conditioner. This can lead to the remote not working.
- Do not splash water or other liquids on the remote.
- Do not put heavy objects on the remote.
- If the air conditioner unit does not make sounds acknowledging sound after proper signals are transmitted, the batteries in the controller might need to be replaced.
- If the remote control is not functioning, replace the batteries and try once again.

REPLACEMENT OF BATTERIES

When the signal is transmitted but the air conditioner does not give an acknowledgment sound. It means the batteries might need to be replaced.

1. Remove the battery case cover and take the used batteries out by sliding the cover open in the arrow direction.
2. Replace with new batteries and pay attention to the "+" and "-" marks of pole indications.
3. Close the back cover.

ADJUSTMENT OF AIR DIRECTION

Up/down adjustment:

Hold the up/down air flap at proper position by hand and move it upward or downward for adjustment.

Left/right adjustment:

Push left/right air direction control tab to adjust the left/right air direction.

ADJUSTMENT OF AIR EXCHANGE

Note: This air exchange adjustment is suitable for those models with the fresh air function. When you want to get fresh air, push the fresh air lever backward by hand. To close the fresh air function, pull the lever forward.

MAINTENANCE

★ Before doing the maintenance, make sure that the air conditioner is turned off and the plug is pulled out from the socket.

Before the operational seasons

- 1 Check to see if there are any objects blocking the in/out airflow of the unit.
- 2 Check to see if the installation base is corroded or rusty.
- 3 Check if the grounding is properly made.

ground wire
- 4 Check if the air filter screen is clean.
- 5 Connect to the proper power source.
- 6 Load batteries in the remote control. (remote control model)

After the operational seasons



- 1 Set the temperature at 30°C(86°F) and let the machine run in cooling mode for half a day. Make the interior of the unit is dry.

- 2 Stop the operation of the machine and turn off the power switch. Always unplug the unit from the power socket when not in use after operating season.

- 3 Clean the air filter screen and install it back into place.
- 4 Clean the indoor and outdoor unit

- 5 Take the batteries out from the remote controller (remote control mode)

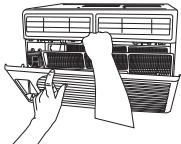
During the operational seasons

Clean the air filter screen (at a standard interval of once every two weeks).

- 1 Remove the air filter screen
 - 1) Gently hold and press the two lower ends of the front grille and open the grille.
 - 2) Gently grab the air filter screen and lift it up, and then take it out in the direction toward you.
- 2 Clean the air filter screen
If the air filter screen is dirty, you may use lukewarm water (about 30°C(86°F)) to clean it, and then air dry.
N.B.:
 - Do not use abrasives, solvents, or boiling water to clean the screen.
 - Remove carefully without too much force as this could break the screen.
- 3 Install the air filter screen
Install the air filter screen: If the air conditioner is operated without an air filter screen, the interior of the unit will be contaminated by dirt, which could cause performance failure or even damage of parts
- 4 Clean the air conditioner
 - Use a soft dry cloth to wipe the air conditioner or use the hose attachment of a vacuum cleaner to do the cleaning.
 - If the air conditioner is very dirty, you may use a piece of cloth soaked with a mild household detergent to remove excess dirt.

N.B.:

If the air filter screen is blocked by dust, the performance of cooling and heating operations will be affected, the operation noise will be larger, and the power consumption will be increased. Therefore, periodic cleaning of the air filter screen is necessary.

TROUBLESHOOTING

Inspection and treatment prior to maintenance

Please check the following items before calling Technical Support.

The air conditioner does not work at all.

Is the power plug inserted into the socket properly?

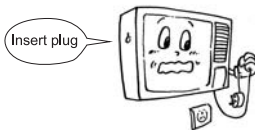

Is there a power failure or is the fuse blown?

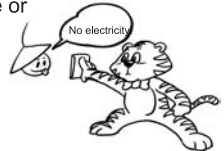

Is the timer set for the "TIMER-ON" mode?

If the air conditioner is set for timed switch-on operation mode, it will not start operating before the set time is reached.

Is the ambient temperature lower than 16°C or 61°F?

If so, the auto protection function of the air conditioner will prevent the unit from cooling operation.

There is no sufficient cooling or heating.

Is the room temperature set properly?

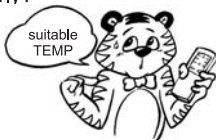

Is the air filter screen dirty?

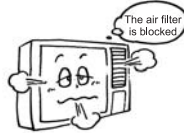

Are the doors or windows opened?



Is the room directly exposed to sunlight?



Are there any heating sources inside the room?



Are there many people inside the room?



Note: If the air conditioner remains abnormal in operation after the above checks and inspection, please disconnect the power and contact customer service. In any of the following cases, please turn off the power of the air conditioner and immediately contact the dealer or the authorized maintenance shop:

The fuse is frequently blown or the breaker is often off.

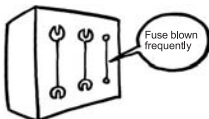

The electric wire turns abnormally hot.



The insulation sheath of the power cable is torn.

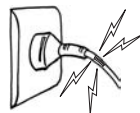



The switches do not work.

There are abnormal noises when the machine is operating.

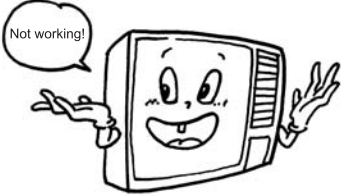
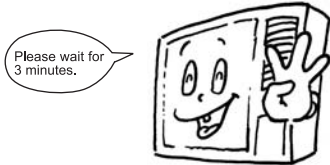

TROUBLESHOOTING

The following phenomena occurring during the operation do not mean faults of the machine. You may use the air conditioner with peace of mind.

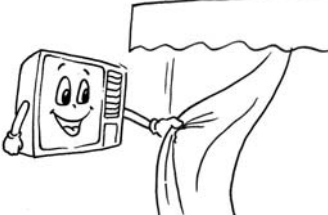
Problem	Solution
<p>The air conditioner cannot be started for operation after it is turned off.</p> 	<p>Start the operation after 3 minutes. This is to protect the air conditioner.</p>  <p>The microchip protection device for 3 minutes' delay performs its function. When the machine is powered for the first time, this function does not work.</p>
<p>Fog is blown out during the cooling operation.</p>	<p>When the indoor temperature and humidity is high, such phenomena might occur. When the indoor temperature and humidity drops, the fog will disappear.</p>
<p>There is a sound from inside the A/C unit.</p>	<p>The cycling of the coolant inside the air conditioner might cause it. Heat expansion and contraction of the plastic parts.</p>
<p>The operation cannot be resumed even the power is turned on after the power switch is turned off or after the power supply is off. (remote control model)</p>	<p>The memory of the microchip computer is deleted. Operate the remote controller to re-start the operation. (remote control model)</p>
<p>No remote control signal is received.</p> 	<p>When the signal receiver on the air conditioner is exposed to sunlight or strong lights, it might fail to receive the remote control signal.</p>  <p>Shade off the sunlight or fade the lighting in this case.</p>
<p>There is moisture at the air outlet grids. Shade off the sunlight or fade the lighting in this case.</p>	<p>If the air conditioner operates in high humidity for long time, moisture may be condensed at the grids and become water drops.</p>

INSTALLATION

INSTALLATION REQUIREMENTS

This room air conditioner is designed for installation in standard double-hung windows with actual opening widths from 31" to 43" (FIG. 1).

Lower sash must open sufficiently to allow a clear vertical opening of 18-5/8". Side louvers and the rear of the air conditioner must have clear air space to allow enough airflow through the condenser for heat removal. The rear of the unit must be outdoors, not inside a building or garage.

INSTALLATION HARDWARE

Before doing the installation, please check to see if the installation accessories are complete (FIG. 2). You must have the screwdriver tools available for installation.

ITEM	NAME OF PARTS	Q'TY
A	SHORT SCREWS	10
B	WOOD SCREWS	13
C	UPPER GUIDE	1
D	SEAL-BOTTOM TO UNIT	1
E	CURTAIN	2
F	CURTAIN LOCK	2
G	SASH LOCK	1
H	WINDOW SASH SEAL	1
I	SCREW AND LOCKNUT	4
J	FLAT HEAD BOLT AND LOCKNUT	2
K	SILL ANGLE BRACKET	2
L	WINDOW SUPPORT BRACKET	2

Note: The number of short screws varies by model.

INSTALLATION POSITION

Pick a location which will allow you to blow the cold air into the area you want. Windows used for installation must be strong enough to support the weight of the air conditioner. Good installation with special attention to the proper position of the unit will lessen the chance that service will be needed.

HOW TO INSTALL

1 REMOVE CHASSIS

- Pull down front panel and remove filter (See FIG. 3). Lift front upwards and place to one side.

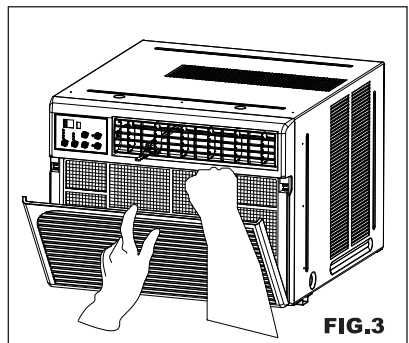
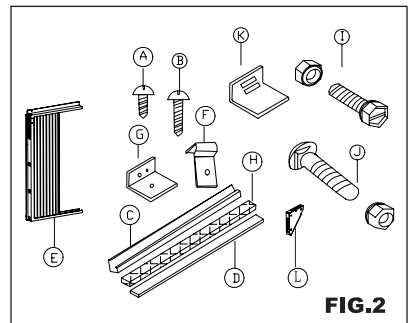
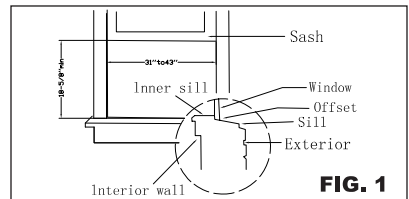
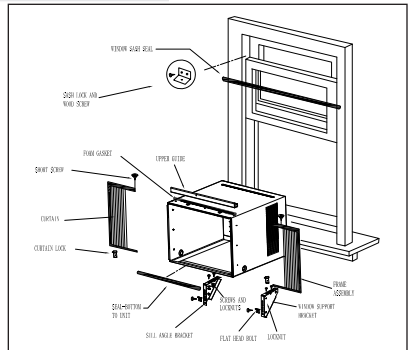

INSTALLATION

- Locate the four front screws and remove. These screws will be needed to re-install the front later (See FIG.4).
- Pry away front from cabinet sides as per hole (See FIG.5).
- Gently lift front off unit and place to one side. Remove the ground screw and save to reinstall later (See FIG.6) .
- Remove shipping screws from top of unit (See FIG.7). Hold the cabinet while pulling on the base handle, and carefully remove the unit.

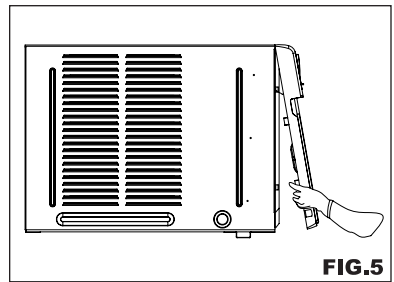
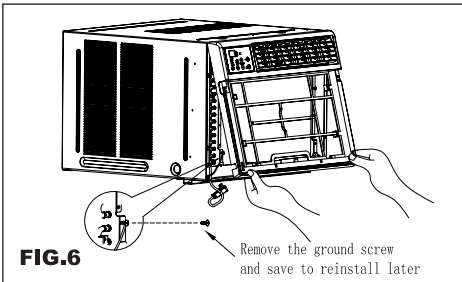
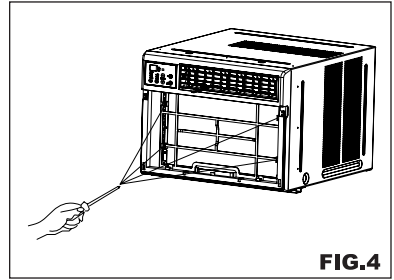

2 INSTALL UPPER GUIDE AND CURTAIN (WINDOW FILLER)

- Place cabinet on floor, a bench, or a table. Remove the upper guide and curtain from the carton, place them on a flat surface.
- Align the hole in the upper guide with those in the top of the unit.
- Secure the upper guide to the unit with short screws as shown in FIG.8.

Note: Higher side of upper guide to be facing the room side.

- Insert top and bottom legs of window filler panel frame into channel to the angle and bottom rail. Do both sides.
- There is a left and a right curtain. Be sure to use the proper curtain for each side.
- Fasten the curtains to the unit with screws as shown in FIG.9.
- Hold the according curtain in one hand and gently pull back the center to free the open end. When installed the flange for securing the curtain into the window sill will be facing the room side.

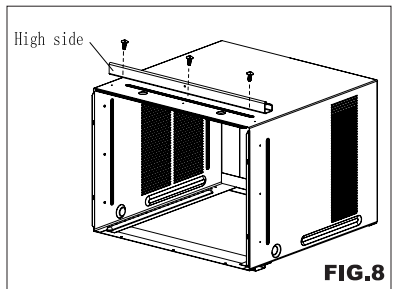
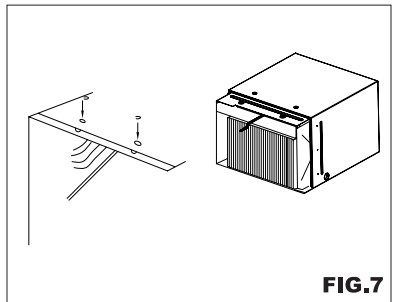

INSTALLATION

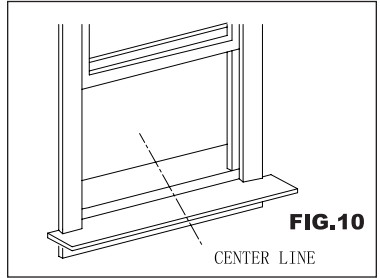
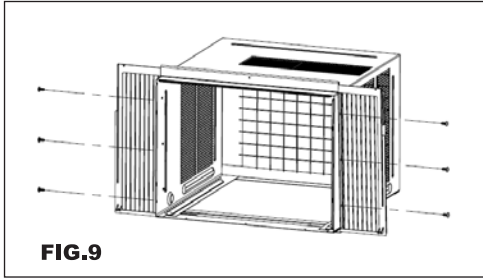

3 PLACE CABINET IN THE WINDOW

- Open window and mark center of window stool.(See FIG.10).
- Place cabinet in window. Bring window down temporarily behind upper guide to hold cabinet in place. Shift cabinet left or right as needed to line up center of cabinet on center line marked on stool.
- Fasten cabinet to window stool with 3 screws into holes.(You may wish to pre-drill pilot holes)
- Add bottom rail seal over screws to window stool (See FIG.11).

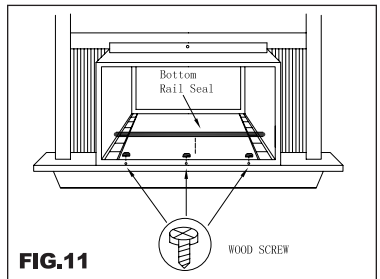

4 INSTALL support bracket

- Hold each support bracket flush against outside of sill, and tight of bottom of cabinet as shown below. Mark brackets at top level of sill, and remove.(see FIG.12)
 - Assemble sill angle bracket to support brackets at the marked position, as shown. Hand tighten, but allow for any changes later.(see FIG.13)
 - Install support brackets (with sill angle brackets attached) to correct hole in bottom of cabinet as shown.(see FIG.14)
- Tighten all 6 bolts securely.

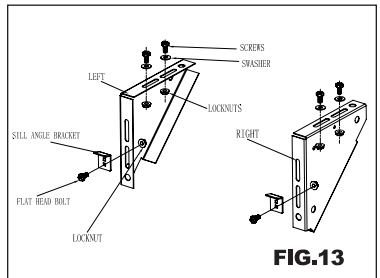
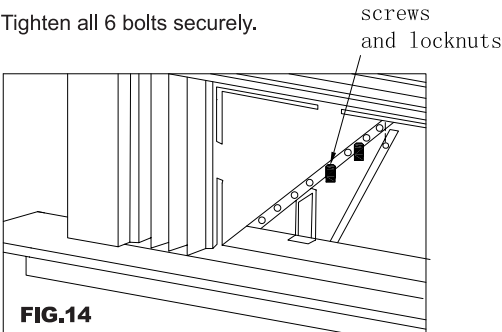
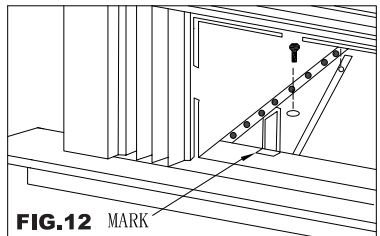

INSTALLATION

5 INSTALL WINDOW LOCK AND SASH SEAL

- Trim sash seal to fit window width. Insert into space between upper and lower sashes (See FIG.15).
- Attach safety lock as shown (See FIG.16).

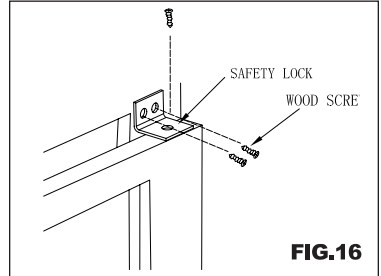
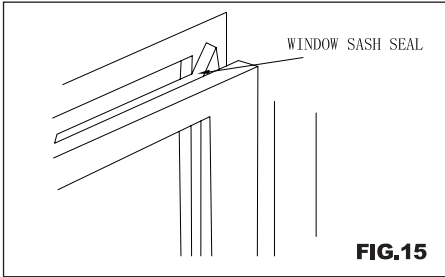

6 INSTALL CHASSIS INTO CABINET AND INSTALL FRONT TO UNIT

- Lift air conditioner and carefully slide into cabinet. Be sure chassis is firmly seated towards rear of cabinet.
- Installation of front is the reverse of removal outlined in section 1

7 SECURE THE AIR CONDITIONER

- Extend the curtain panels to fill the window opening.
- Place the curtain lock between the curtain extensions and the window sill, drive locking screws through the lock and into the sill.
- Secure the left and right flanges on end bottom side of the panel with wood screws.
- Drive locking screws through upper frame holes into window sash. (See FIG.17)

8 TEST RUNNING

- Connect to power source, check to see if the operational mode buttons work properly.
- Check to see if the room temperature control and the function controls work properly.
- Check if there are any abnormal sounds during operations.

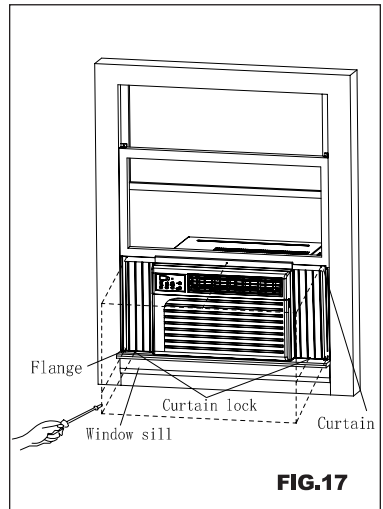

INSTALLATION

IF AC IS BLOCKING BY STORM WINDOW

- Add woods as shown in FIG.18,or remove storm window before air conditioner is installed.
- If storm window frame must remain,be sure the drain holes or slots are not caulked or painted shut. Accumulated rain water or condensation must be allowed to drain out.

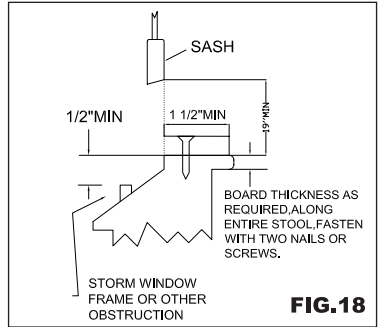

REMOVAL FROM WINDOW

- Turn AC off,and disconnect power cord.
- Remove sash seal from between windows,and unscrew sash lock.
- Unscrew curtain lock and remove screws installed through curtain.
- Close curtain panels into frame.
- Keeping a firm grip on the air conditioner,raise the sash,and carefully tilt the air conditioner backward,draining any condensate water in the base of unit.Be careful not to spill any remaining water while lifting unit from window.
- Store parts with air conditioner.

CAUTION FOR DISMANTLING THE AIR CONDITIONER (It is just suitable for those models with fresh air function)

- If you purchase the models with fresh air function,while dismantling the air conditioner to repair the inner parts(such as condensator,evaporator ,copper pipe etc.),be sure to first remove the air-guide frame,pull upward the fresh air lever to make it disengage from its place(FIG.19) ,and then continue the other dismantling work.

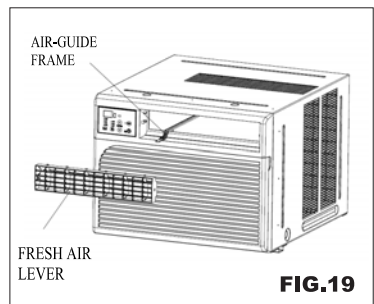

4 MONTHS LIMITED WARRANTY

The manufacturer warrants this unit against defects in materials and workmanship on functional parts, for a period of 4 months from the original date of purchase. Your sales receipt showing the date of purchase of the product is your proof of purchase. Keep it in a safe place for future reference.

This product is made with the highest quality materials and is warranted to be free from defects in materials and workmanship at the time of purchase. This limited warranty applies to products manufactured or distributed by the manufacturer, are delivered in the continental United States, and extends to the original purchaser, or gift recipient. This warranty becomes valid at the time of purchase and terminates either by the specified time frame listed above and/or owner transfer. Any refunds or monetary compensations must be claimed through the place of purchase (retailer), and not through the manufacturer. Any extended warranties (warranties that cover above and beyond this manufacturer warranty) that are sold through a retailer or third party, are not directly correlated with this products* limited warranty, and may be redirected to said retailer or third party for coverage.

This warranty extends through the manufacturer of the product, and covers functional parts only. Cosmetics are not covered, unless unequivocally determined it is a workmanship defect. Shipping damage should be addressed with the shipping company, retailer, or place of purchase, not the manufacturer unless the manufacturer was the direct shipper.

The manufacturer* sole obligation under this warranty shall be limited to furnishing the original purchaser replacement parts for units deemed repairable by the supplier* warranty department, The purchaser is responsible for insuring any parts shipped or returned, if desired. The purchaser is responsible to prepay any shipping charges (both ways) including, but not limited to taxes and duties. All exchanged parts and products replaced under this warranty will become the property of manufacturer. The manufacturer reserves the right to change manufacturers of replacement parts or products for use, in order to cover any existing warranty.

The purchaser may be asked to provide the supplier with proof of purchase documents (including the date of purchase) if requested. Any evidence of alteration, erasing, or forgery of proof of purchase documents will be just cause to VOID this limited warranty. Products, in which the serial number has been defaced or removed, are not eligible for warranty coverage.

This warranty does not apply if the unit has been subject to negligence, fabrication, misuse, abuse, or repairs, alteration by non-manufacturer authorized personnel, inappropriate installations, or any case beyond the control of the manufacturer. Examples of warranty invalidation may also include, but are not limited to:

- Use of lacquer or paints in (and around) the unit
- Electrical requirement deficiencies (15-20 amp dedicated outlet)
- Use on extension cords/timers/surge protectors/GFCI
- Outdoor applications
- Normal wear/tear/weathering
- Pet/consumer accidents

The manufacturer shall not be liable for any loss due to use (or misuse) of the unit or other incidental or consequential costs, expense or damages without irrefutable foundations. Under no circumstances shall the manufacturer or any of its representatives be held liable for injury to any person or damage to any property, however arising. Any implied warranty shall have duration equal of the applicable warranty stated above. Specifications are subject to change without notice or obligation.

This limited warranty gives the original purchaser specific legal rights. Other rights may vary from state to state.

