



MODEL NUMBERS

CL-RAC05EW
CL-RAC05EW-6A

5,000 BTU WINDOW AIR CONDITIONER

OPERATING INSTRUCTIONS



BEFORE RETURNING UNIT TO THE STORE

READ ALL QUESTIONS ON OPERATION AND WARRANTY

PLEASE VISIT OUR WEBSITE AT WWW.COOLLIVINGPRODUCTS.COM CALL 1-800-752-5262 OR EMAIL CUSTOMERSERVICE@1KMS.COM

PRODUCT REGISTRATION CARD MUST BE COMPLETED ONLINE OR COMPLETE AND MAIL THE ATTACHED REGISTRATION CARD TO

KMS INC. ATTN: CUSTOMER SERVICE, 811 E WATERMAN, WICHITA, KS 67202

INTRODUCTION

IMPORTANT SAFETY INSTRUCTIONS.....	1
ELECTRICAL REQUIREMENTS.....	2
PACKING LIST.....	3
INSTALLATION & ASSEMBLY INSTRUCTIONS.....	4
USING YOUR AIR CONDITIONER	7
CARE AND CLEANING	10
TROUBLESHOOTING.....	11
WARRANTY.....	13
REGISTRATION CARD.....	14

IMPORTANT SAFETY INSTRUCTIONS

Before installing and using your air conditioner, please read this owner's manual carefully. Store this manual in a safe place for future reference. Your safety and the safety of others is very important to us. Please pay attention to all safety messages outlined in this owner's manual.

WARNING: To reduce the risk of fire, electrical shock or injury when using your air conditioner, follow the basic precautions below:

- Plug into a grounded 3 prong outlet.
- Do not remove the ground prong.
- Do not use a plug adapter.
- Do not use an extension cord.
- Unplug the air conditioner before servicing.
- Use two or more people to move and install the air conditioner.



This is a safety alert symbol.

This symbol alerts you to potential hazards that can harm you or others or even cause death.

All safety messages will directly follow the safety alert symbol and/or the words "DANGER" or "WARNING".

⚠ DANGER

⚠ WARNING

Failure to immediately follow these instructions may cause serious injury or even death.

All Safety messages alert you of potential hazards, how to reduce the chance of injury, and what can happen if instructions are not followed correctly.

ELECTRICAL REQUIREMENTS

⚠ WARNING



Electrical Shock Hazard

Plug into a grounded 3 prong outlet.
Do not remove the ground prong.
Do not use an adapter.
Do not use an extension cord.
Failure to follow these instructions can result in death, fire, or electrical shock.

The electrical ratings for your air conditioner are listed on the model and serial number label located on the front left side of the unit (when facing the front).

Specific electrical requirements are listed in the chart below. Follow the requirements below for the type of plug on the power supply cord.

Wiring Requirements

- 115 volt (103 min.—127 max)
- 0-8 amps
- 10-amp time-delay fuse or circuit breaker
- Use on single outlet circuit only

Power Supply Cord

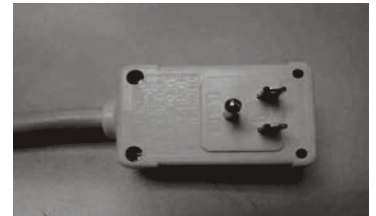

Recommended Ground Method

For your personal safety, this air conditioner must be grounded. This air conditioner is equipped with a 3 prong power supply cord with a grounded plug. To minimize the possibility of electrical shock, the cord must be plugged into a 3 prong outlet and grounded in accordance with all local codes and ordinances. If a 3 prong outlet is not available, it is the customer's responsibility to have a properly grounded 3 prong outlet installed by a qualified electrician.

It is the customer's responsibility:

- To contact a qualified electrician.
- To assure that the electrical installation is adequate and in conformance with the National Electrical Code, ANSI/NFPA 70 - latest edition, and all local codes and ordinances.

Copies of the standards listed may be obtained from:

National Fire Protection Association
One Batterymarch Park
Quincy, Massachusetts 02269

LCDI Power Cord and Plug

This air conditioner is equipped with an LCDI (Leakage Current Detection and Interruption) power cord and plug as required by US National Electric Code 440.65. This cord consists of a length of shielded flexible cord with no termination on the load side and a LCDI attachment plug on the line side.

The LCDI power cord and plug will remove the supply source via electrical disconnect (circuit trip) if the nominal current leakage between the cord shield and either load conductor exceeds a predetermined value. The cord will remain de-energized until the device has been manually reset. This is intended to reduce the risk of a fire in the power cord or combustible materials nearby. The cord shields are not grounded and they must be considered a shock hazards if exposed. The cord shield must not be connected to ground or to any exposed metal.

The test and reset buttons on the LCDI Plug are used to check if the plug is functioning properly. To test the plug:







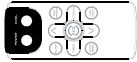
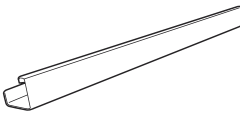

1. Plug power cord into a wall outlet
2. Press the TEST Button, the circuit should trip and cut all power to the air conditioner
3. Press the RESET button for use

If a test is performed and the indicator light remains ON, the current leakage has been detected. Do not use the air conditioner or attempt to reset the LCDI Plug. Contact Customer Service for troubleshooting recommendations.

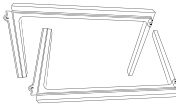

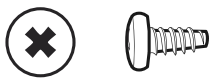
PACKING LIST

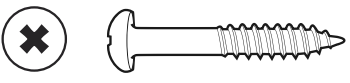
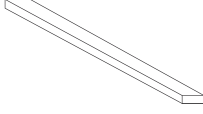
(appearance may vary)

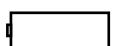
IMAGE	PART	QUANTITY
	Window Air Conditioner	1
	Remote Control	1
	Top Mounting Rail (Putting on the top of package foam with sponge)	1
	Lock Frame	2
	Filler Panels (With "Left" & "Right" on the front face)	2
	Sash Lock (Two holes)	1
	Window Sash Seal (Sponge)	1
	3/8" Screws	4
	1/2" Screws	3
	3/4" Screws	4
	Foam Top Window Gasket (Thin sponge for backup using)	1
	Insulation strip(Sponge)	2
	Battery	2

DISCLAIMER

ALL INFORMATION AND THE TECHNICAL SPECIFICATIONS PRESENTED IN THIS OWNER'S MANUAL ARE THE PRESENTATION OF THE MANUFACTURER. KMS HAS NOT CONDUCTED AN INDEPENDENT TEST TO THE INFORMATION AND THE SPECIFICATIONS PRESENTED HERE WITHIN.

INSTALLATION & ASSEMBLY INSTRUCTIONS

Some assembly is required for your new air conditioner. Please read and follow these instructions carefully.

1. This air conditioner is designed to be installed in a standard double-hung window with a window width between 23" and 36" (584 mm - 914 mm).
2. The air conditioner can be installed without the accordion panels to fit in a narrow window opening. See the window dimensions.
3. The Lower Sash (the lower part of the window that moves up and down) must allow for 14.5" of vertical clearance when open. (See FIG. 1).
4. All supporting parts must be secured to firm wood, masonry, or metal.
5. The electrical outlet must be within reach of the power cord.

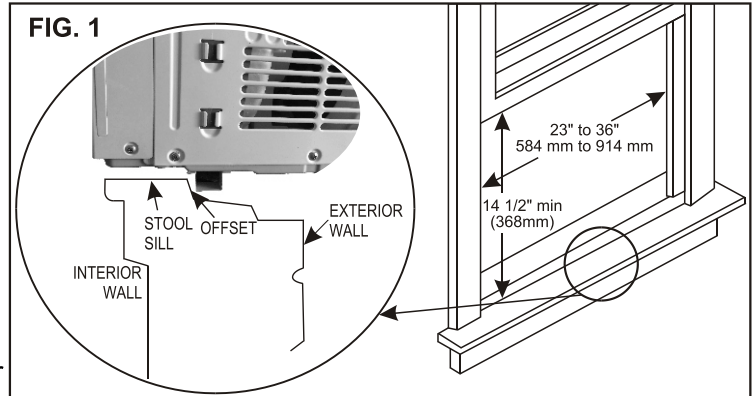



NOTE: Save the product packaging and installation instructions for future reference. Store the air conditioner in the product box when not in use for an extended period of time.

Top Rail Assembly

The top rail must be assembled prior to installing the air conditioner in the window

Tools Needed: Phillips Head Screw Driver

Top Rail Hardware		QTY
	3/8" Screw	4
	Top Rail	1

Attaching the Top Rail to the Air Conditioner

1. Remove the air conditioner from the box and place on a hard and flat surface.
2. Remove top rail from the top of the packaging material as shown in FIG. A.
3. Align the hole in the top rail with those in the top of the unit as shown in FIG. B.
4. Secure the top rail to the unit with the 3/8" screws as shown in FIG. C.

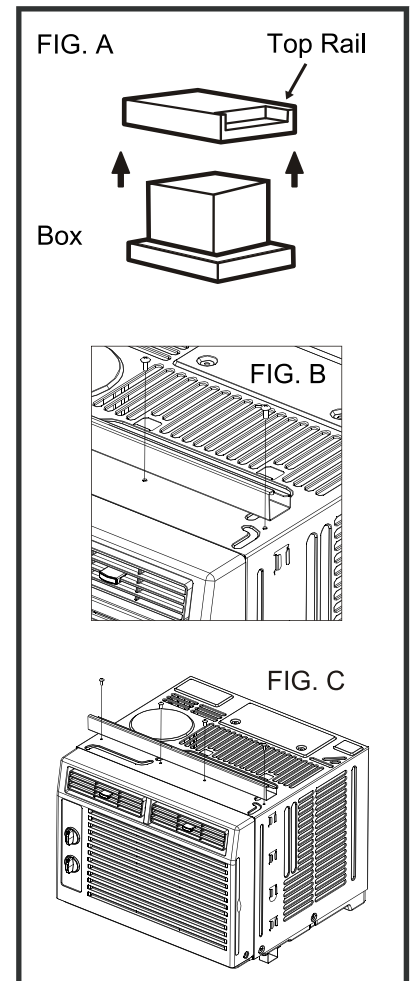

NOTE: For safety reasons, all 4 screws must be used to attach the top rail.

CAUTION

When handling the unit, be careful to avoid cuts from the sharp metal edges and aluminum fins on the front and rear coils.

ASSEMBLY & INSTALLATION (CONT.)

Accordion Panel Installation

Now that you have installed the top rail, you can now install the accordion panels on each side.

1. Place the air conditioner on a hard flat surface.
2. Locate the accordion panels in the box.
3. Gently pull the free end of the accordion panel (See FIG. 2). Do this for both panels.



4. Slide the free end of the accordion panel into the side panel of the air conditioner (See FIG. 3). Do this for each side.



5. Once the accordion panels are slid into place adjust the top and bottom rails of the accordion panels into the top and bottom rails of the air conditioner (See FIG. 4).



Storm Window Requirements

A storm window frame will not allow the air conditioner to tilt properly which in turn will keep it from draining properly. To adjust for this, attach a board or piece of wood to the sill. The board or wood piece should have a depth of at least 1 1/2". Make sure the board or piece of wood is approximately 1/2" higher than the storm window frame. This will allow the air conditioner to tilt enough for proper drainage. (See FIG. 5).

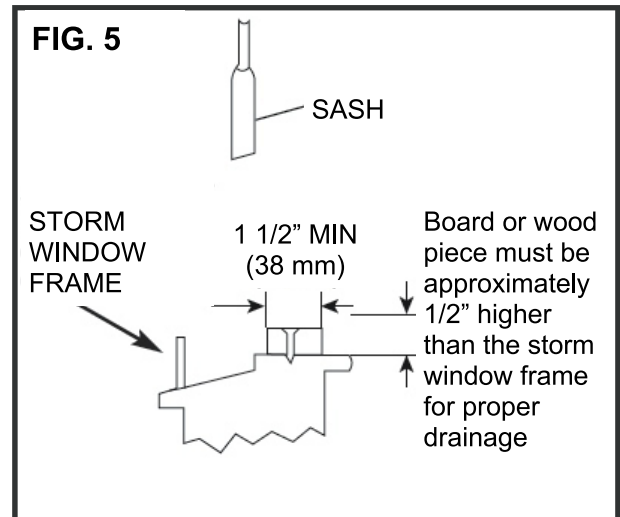

Placing the Unit Inside a Window

1. Place the air conditioner on the sill with the bottom mounting rail against its back edge. Center the air conditioner and close the window securely behind the top mounting rail. The air conditioner should be slightly tilted to the outside area. Use a level; about a 1/3 bubble will be the correct case slant to the outside. (See FIG. 6 & FIG. 7) (It is suggested to keep a downward angle to let accumulated rain water drain out from the back side of the unit bottom.)

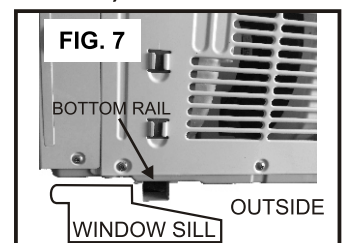
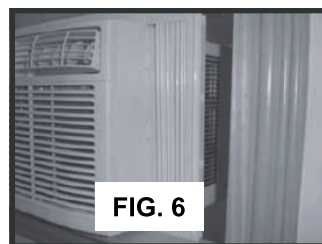



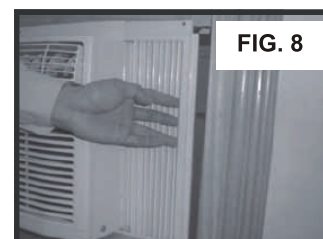

2. Once the air conditioner is placed, extend both the left and right accordion panels to the width of the window.



ASSEMBLY & INSTALLATION (CONT.)

Frame Lock, Sash Lock, and Foam Seal Installation

MOUNTING HARDWARE		
	3/4" Screws	Qty 4
	1/2" Screws	3
	Frame Lock	2
	Sash Lock	1

Tools Needed:

Phillips Head Screw Driver
Drill (if pilot holes are needed)

- Place the frame lock between the extended accordion panels and the window sill as show in FIG. 9. Screw a 3/4" (19 mm) locking screw through the frame lock and into the window sill. (FIG. 10)



- Drive 1/2" screws into the top of the accordion panel frame and the top rail to securely attach the window air conditioner to the lower sash. (See FIG. 11/12)

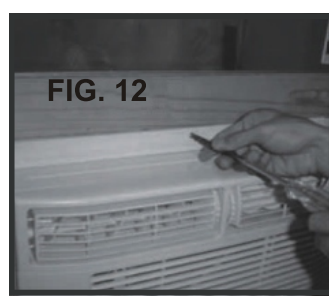

- To secure the lower sash into place, use the sash lock and a 3/4" screw as shown below. (See FIG. 13)



- For added insulation, cut the supplied insulation foam to the width of the window. Insert the foam between the window sashes to prevent air and objects from getting into the room. (See FIG. 14)



Removing the Air Conditioner from the Window

- Turn the air conditioner off and unplug the power cord.
- Remove the sash seal from between windows, and unscrew sash lock.
- Remove the screws installed through the frame and frame lock.
- Close (slide) the side panels into frame.
- Keeping a firm grip on air conditioner, raise the sash and carefully "rock" air conditioner backward to drain any condensate water in base of unit. Be careful not to spill any remaining water while lifting unit from window.
- Store parts WITH the air conditioner in the box.

USING YOUR AIR CONDITIONER Manual Control Panel

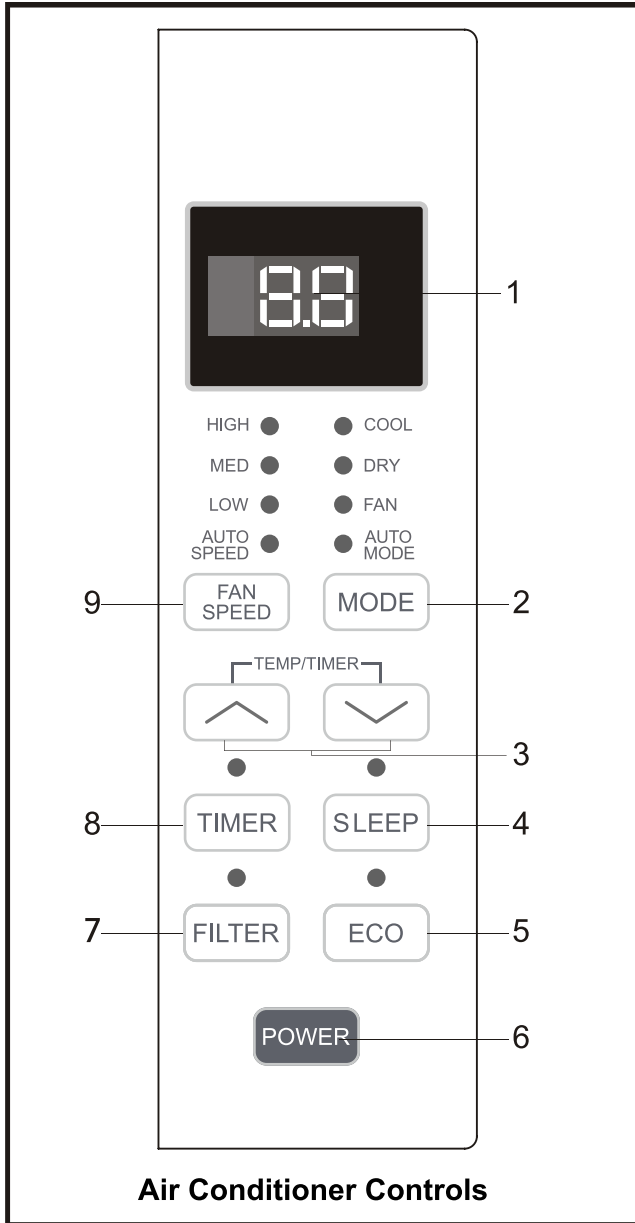

Normal Operating Sounds

- You may hear a pinging noise caused by water hitting the condenser, on rainy days, or when the humidity is high. This design feature helps remove moisture and improve efficiency.
- You may hear the thermostat click when the compressor cycles on and off.
- Water will collect in the base pan during rain or days of high humidity. The water may overflow and drip from the outside part of the unit.
- The fan may run even when the compressor is not on.

1. **Digital Display:** When the timer is not in use, the operation mode and the set temperature will be displayed. Time will be displayed under the timer setting.
2. **Mode Button:** Press the mode button to cycle through the various modes: Cool, Dry, Fan and Auto.

Cool Mode: The cooling function allows the air conditioner to cool the room and at the same time reduces humidity. Press the MODE button to activate the cooling function. To optimize this function adjust the temperature by pressing the up and down arrows and the speed by pressing the Fan Speed button.

Dry Mode: This function reduces the humidity of the air to make the room more comfortable. Press the MODE button to set the DRY mode. An automatic function of alternating cooling cycles and air fan is activated.

Fan Mode: This function only works when the air conditioner is vented. Press the MODE button to set the FAN mode. With pressing the FAN SPEED button, the speed changes in the following sequence: Hi, Med and Lo in FAN mode.

Auto Mode: In AUTO mode the unit automatically chooses the mode of operation (COOL, DRY, or FAN). In this mode the temperature is set automatically according to the room temperature (Room temperature is determined by the temperature sensor located in the indoor unit).
3. **▲ and ▼ Button:** Use these buttons on the control panel and remote to increase or decrease the Set Temperature or Timer.
Temperature range: 61°F ~88°F or 16°C ~31°C.
4. **Sleep Button:** Press the SLEEP button, all of the display lights will turn off after a while, but the Sleep light is always on. In SLEEP mode, the air conditioner will automatically adjust the temperature and fan speed to make the room more comfortable during the night. The set temperature will automatically raise every 30-60 minutes, and at most change six times until the set temperature is 81 or 82°F.

5. **Eco Button:** When the unit is in ECO mode, the light will turn on. In ECO mode, the unit will turn off once the room is cooled to the user-set temperature.
The unit will turn back on when the room temperature rises above the user-set temperature. Before the compressor starts, the fan motor will run for a while, then it will stop for a while, and will repeat to provide a much more comfortable feeling and save energy.

6. **Power Button:** Turn the air conditioner on and off.

7. **Filter Button:** When the Filter Check light is off, it is not necessary to press the Filter Check button. When the Filter Check light is on, you can turn off the light by pressing the Filter Check button. After the fan motor works for 500 total hours, the Filter Check light will turn on to remind the user to clean the filter.

8. **Timer Button:** Use these buttons on the control panel and remote to set the Timer.
Timer Off: The timed stop is programmed by pressing TIMER button. Set the rest time by pressing the button “^” or “v” until the rest time displayed is to your demand then press TIMER button again.
Timer On: When the unit is off, press TIMER button at the first time, set the temperature with pressing the button “^” or “v”. Press TIMER button at the second time, set the rest time with pressing the button “^” or “v”. Press TIMER button at the third time, confirm the setting, then it will show on the display.

Note: It can be set to automatically turn off or on in 0.5-24 hours. Each press of the “^” “v” buttons will increase or decrease the timer. The Timer can be set in 0.5 hours increment below 10 hours and 1 hour increment for 10 hours or above. The SET light will turn on while setting. To cancel the set function, press the TIMER button again.

9. **Fan Speed Button:** Press the FAN SPEED button to select the fan speed. In COOL MODE you can choose the following settings: HI, MED, LO, or AUTO. In FAN MODE you can choose from HI, MED, and LO.

10. **Directional Louvers:** Use the horizontal wheels to control horizontal airflow and the air deflectors to control vertical airflow.

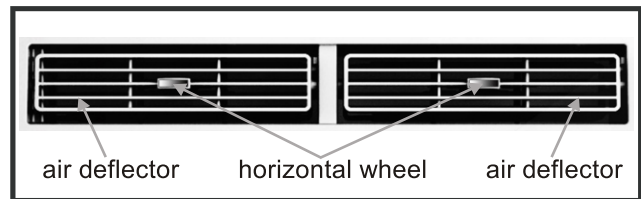

OPERATING YOUR AIR CONDITIONER

REMOTE CONTROL



1. **Power:** Turn the air conditioner on and off.
2. **Cool:** Press the COOL button to COOL mode.
3. **^ and v:** Use these buttons on the control panel and remote to increase or decrease the Set Temperature or Timer. Temperature range: 61°F~88°F or 16°C~31°C.
4. **Sleep:** Press the SLEEP button, all of the display lights will turn off after a while, but the Sleep light is always on. In SLEEP mode, the air-conditioner will automatically adjust the temperature and fan speed to make the room more comfortable during the night. The set temperature will automatically raise every 30-60 minutes and at most change six times until the set temperature is 81 or 82°F.

5. **Timer:** Use these buttons on the control panel and remote to set the Timer.
Timer Off: The timed stop is programmed by pressing TIMER button. Set the rest time by pressing the button “^” or “v” until the rest time displayed is to your demand then press TIMER button again.
Timer On: When the unit is off, press TIMER button at the first time, set the temperature with pressing the button or “^”. Press “v” TIMER button at the second time, set the rest time with pressing the button or “^”. Press “v” TIMER button at the third time, confirm the setting, then the rest time to next automatical switching-on could be read on the display of the machine.
Note: It can be set to automatically turn off or on in 0.5-24 hours. Each press of the “^” “v” buttons will increase or decrease the timer. The Timer can be set in 0.5 hours increment below 10 hours and 1 hour increment for 10 hours or above. The SET light will turn on while setting. To cancel the set function, press the TIMER button again.
6. **Auto Mode:** In AUTO mode the unit automatically chooses the mode of operation(COOL, DRY or FAN). In this mode the temperature will be set automatically according to the room temperature (tested by the temperature sensor which is incorporated in the indoor unit.).
7. **Fan Speed:** Press the FAN SPEED button to choose the fan speed options. You can choose Hi, Med, Lo or auto speed in COOL mode and choose Hi, Med, Lo in FAN mode.
8. **Display:** To press the DISPLAY button, it can switch off/on all lights or LED display.
9. **Eco:** When the unit is in ECO mode, the light will turn on. In ECO mode, the unit will turn off once the room is cooled to the user set temperature. The unit will turn back on when the room temperature rises above the user set temperature. Before the compressor starts, the fan motor will run for a while, then it will stop for a while, and will repeat to provide a much more comfortable feeling and save energy.
10. **Fan Only:** Press the Fan Only button to FAN ONLY mode.

Battery Size: AAA - NOTE: Do not mix old and new batteries or different types of AAA batteries.

CARE AND CLEANING

Clean your air conditioner to keep it looking new and to minimize dust build up.

Air Filter Cleaning

The air filter should be checked at least once every month to see if it needs cleaning. Trapped particles and dust can build up in the filter and may decrease airflow as well as cause the cooling coils to accumulate frost. To clean the air filter:

1. Remove the filter by sliding it out from the front right side of the air conditioner. (See FIG. 15)
2. Wash the filter using liquid dish soap and warm water. Rinse the filter thoroughly. Gently shake the filter to remove excess water.
3. Let the filter dry completely before placing it into the air conditioner.
4. If you do not wish to wash the filter, you may vacuum the filter to remove the dust and other particles.

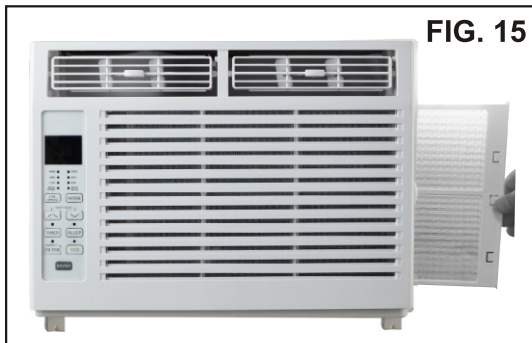

Cabinet Cleaning

To clean the air conditioner cabinet:

- Unplug the air conditioner to prevent shock or a fire hazard. The cabinet and front panel of the air conditioner may be dusted with an oil-free cloth or washed with a cloth dampened in a solution of warm water and mild liquid soap. Rinse thoroughly with a damp cloth and wipe dry.
- Never use harsh cleaners, wax or polish on the cabinet front.
- Be sure to wring excess water from the cloth before wiping around the controls. Excess water in or around the controls may cause damage to the air conditioner.

Winter Storage

To store the air conditioner when it is not in use for an extended period of time, remove it carefully from the window according to the installation instructions and cover it with plastic or place it in the original box.

TROUBLESHOOTING

PROBLEM	POSSIBLE CAUSES	SOLUTIONS
The Air Conditioner will not start	The air conditioner is unplugged	<ul style="list-style-type: none"> Make sure the air conditioner plug is pushed completely into the outlet
	The fuse is blown/circuit breaker is tripped	<ul style="list-style-type: none"> Check the house fuse/circuit breaker box and replace the fuse or reset the breaker
	Power failure	<ul style="list-style-type: none"> The unit will automatically re-start when power is restored There is a protective time delay (approx. 3 minutes) to prevent tripping of the compressor overload. For this reason, the unit may not start normal cooling for 3 minutes after it is turned back on.
	The current interrupter device is tripped	<ul style="list-style-type: none"> Press the RESET button located on the power cord plug If the RESET button will not stay engaged, discontinue use of the air conditioner and contact a qualified service technician
The Air Conditioner does not cool as it should	Airflow is restricted	<ul style="list-style-type: none"> Make sure there are no curtains, blinds, or furniture blocking the front of the air conditioner
	The temperature control may not be set correctly	<ul style="list-style-type: none"> Lower the set thermostat temperature
	The air filter is dirty	<ul style="list-style-type: none"> Clean the filter. See the Cleaning and Care Section of the manual
	The room may be too warm	<ul style="list-style-type: none"> Please allow time for the room to cool down after turning on the air conditioner
	Cold air is escaping	<ul style="list-style-type: none"> Check for open furnace registers and cold air returns
	The cooling coils are frozen	<ul style="list-style-type: none"> See "Air Conditioner Freezing Up" below
The Air Conditioner is freezing up	Ice blocks the air flow and stops the air conditioner from cooling the room	<ul style="list-style-type: none"> Set the MODE dial to HIGH FAN or HIGH COOL and set the thermostat to a higher temperature
The Remote Control is not working	The batteries are inserted incorrectly	<ul style="list-style-type: none"> Check the position of the batteries
	The batteries may be dead	<ul style="list-style-type: none"> Replace the batteries

TROUBLESHOOTING (CONT.)

PROBLEM	POSSIBLE CAUSES	SOLUTIONS
Water is dripping outside	Hot and humid weather	<ul style="list-style-type: none">• This is normal
Water is dripping inside the room	The air conditioner is not correctly tilted outside	<ul style="list-style-type: none">• For proper water drainage, make sure the air conditioner is slightly tilted downward from the front of the unit to the rear
Water collects in the base pan	Moisture removed from the air is draining into the base pan	<ul style="list-style-type: none">• This is normal for a short period in areas with low humidity and normal for a longer period in areas with high humidity

WARRANTY

6 MONTHS LIMITED WARRANTY

IN ORDER TO UTILIZE THE WARRANTY YOU MUST REGISTER YOUR PURCHASE WITH IN 30 DAYS FROM THE DATE OF PURCHASE.

THE MANUFACTURER WARRANTS THIS UNIT AGAINST DEFECTS IN MATERIALS AND WORKMANSHIP ON FUNCTIONAL PARTS, FOR A PERIOD OF 6 MONTHS FROM THE ORIGINAL DATE OF PURCHASE. YOUR SALES RECEIPT SHOWING THE DATE OF PURCHASE OF THE PRODUCT IS YOUR PROOF OF PURCHASE. KEEP IT IN A SAFE PLACE FOR FUTURE REFERENCE.

THIS PRODUCT IS MADE WITH THE HIGHEST QUALITY MATERIALS AND IS WARRANTED TO BE FREE FROM DEFECTS IN MATERIALS AND WORKMANSHIP AT THE TIME OF PURCHASE. THIS LIMITED WARRANTY APPLIES TO PRODUCTS MANUFACTURED OR DISTRIBUTED BY THE MANUFACTURER, ARE DELIVERED IN THE CONTINENTAL UNITED STATES, AND EXTENDS TO THE ORIGINAL PURCHASER, OR GIFT RECIPIENT. THIS WARRANTY BECOMES VALID AT THE TIME OF PURCHASE AND TERMINATES EITHER BY THE SPECIFIED TIME FRAME LISTED ABOVE AND OR OWNER TRANSFER. ANY REFUNDS OR MONETARY COMPENSATIONS MUST BE CLAIMED THROUGH THE PLACE OF PURCHASE (RETAILER), AND NOT THROUGH THE MANUFACTURER. ANY EXTENDED WARRANTIES (WARRANTIES THAT COVER ABOVE AND BEYOND THIS MANUFACTURER WARRANTY) THAT ARE SOLD THROUGH A RETAILER OR THIRD PARTY, ARE NOT DIRECTLY CORRELATED WITH THIS PRODUCTS* LIMITED WARRANTY, AND MAY BE REDIRECTED TO SAID RETAILER OR THIRD PARTY FOR COVERAGE.

THIS WARRANTY EXTENDS THROUGH THE MANUFACTURER OF THE PRODUCT, AND COVERS FUNCTIONAL PARTS ONLY. COSMETICS ARE NOT COVERED, UNLESS UNEQUIVOCALLY DETERMINED IT IS A WORKMANSHIP DEFECT. SHIPPING DAMAGE SHOULD BE ADDRESSED WITH THE SHIPPING COMPANY, RETAILER, OR PLACE OF PURCHASE, NOT THE MANUFACTURER UNLESS THE MANUFACTURER WAS THE DIRECT SHIPPER.

THE MANUFACTURER* SOLE OBLIGATION UNDER THIS WARRANTY SHALL BE LIMITED TO FURNISHING THE ORIGINAL PURCHASER REPLACEMENT PARTS FOR UNITS DEEMED REPAIRABLE BY THE SUPPLIER* WARRANTY DEPARTMENT. THE PURCHASER IS RESPONSIBLE FOR INSURING ANY PARTS SHIPPED OR RETURNED, IF DESIRED. THE PURCHASER IS RESPONSIBLE TO PREPAY ANY SHIPPING CHARGES (BOTH WAYS) INCLUDING, BUT NOT LIMITED TO TAXES AND DUTIES. ALL EXCHANGED PARTS AND PRODUCTS REPLACED UNDER THIS WARRANTY WILL BECOME THE PROPERTY OF MANUFACTURER. THE MANUFACTURER RESERVES THE RIGHT TO CHANGE MANUFACTURERS OF REPLACEMENT PARTS OR PRODUCTS FOR USE, IN ORDER TO COVER ANY EXISTING WARRANTY. THE PURCHASER MAY BE ASKED TO PROVIDE THE SUPPLIER WITH PROOF OF PURCHASE DOCUMENTS INCLUDING THE DATE OF PURCHASE. ANY EVIDENCE OF ALTERATION, ERASING OR FORGERY OF PROOF OF PURCHASE DOCUMENTS WILL BE JUST CAUSE TO VOID THIS LIMITED WARRANTY. PRODUCTS, IN WHICH THE SERIAL NUMBER HAS BEEN DEFACED OR REMOVED, ARE NOT ELIGIBLE FOR WARRANTY COVERAGE.

THIS WARRANTY DOES NOT APPLY IF THE UNIT HAS BEEN SUBJECT TO NEGLIGENCE, FABRICATION, MISUSE, ABUSE OR REPAIRS; ALTERATION BY NON-MANUFACTURER AUTHORIZED PERSONNEL, INAPPROPRIATE INSTALLATIONS OR ANY CASE BEYOND THE CONTROL OF THE MANUFACTURER. EXAMPLES OF WARRANTY INVALIDATION MAY ALSO INCLUDE, BUT ARE NOT LIMITED TO:

- *USE OF LACQUER OR PAINTS IN (AND AROUND) THE UNIT
- *ELECTRICAL REQUIREMENT DEFICIENCIES (15-20 AMP DEDICATED OUTLET)
- *USE ON EXTENSION CORDS/TIMERS/SURGE PROTECTORS/GFCI
- *OUTDOOR APPLICATIONS
- *NORMAL WEAR / TEAR / WEATHERING
- *PET / CONSUMER ACCIDENTS

THE MANUFACTURER SHALL NOT BE LIABLE FOR ANY LOSS DUE TO USE (OR MISUSE) OF THE UNIT OR OTHER INCIDENTAL OR CONSEQUENTIAL COSTS, EXPENSES OR DAMAGES WITH OUT IRREFUTABLE FOUNDATIONS. UNDER NO CIRCUMSTANCES SHALL THE MANUFACTURER OR ANY OF ITS REPRESENTATIVES BE HELD LIABLE FOR INJURY TO ANY PERSON OR DAMAGE TO ANY PROPERTY, HOWEVER ARISING. ANY IMPLIED WARRANTY SHALL HAVE DURATION EQUAL OF THE APPLICABLE WARRANTY STATED ABOVE. SPECIFICATIONS ARE SUBJECT TO CHANGE WITHOUT NOTICE OR OBLIGATION. THIS LIMITED WARRANTY GIVES THE ORIGINAL PURCHASER SPECIFIC LEGAL RIGHTS. OTHER RIGHTS MAY VARY FROM STATE TO STATE.

IN ORDER TO UTILIZE THE WARRANTY YOU MUST REGISTER YOUR PURCHASE WITH IN 30 DAYS FROM THE DATE OF PURCHASE.

REGISTRATION CARD

PRODUCT REGISTRATION CARD MUST BE COMPLETED ONLINE AT WWW.COOLLIVINGPRODUCTS.COM OR COMPLETE AND MAIL THE ATTACHED REGISTRATION CARD TO KMS INC. ATTN: CUSTOMER SERVICE, 811 E WATERMAN, WICHITA, KS 67202

DATE OF PURCHASE: _____ PURCHASED FROM: _____

BRAND: _____ MODEL #: _____

IF YOU DO NOT REGISTER YOUR WARRANTY ONLINE AT WWW.COOLLIVINGPRODUCTS.COM PLEASE FILL OUT AND MAIL THIS BOTTOM PORTION AT THE LINE BELOW. KEEP THE REST OF THIS INFORMATION IN A SAFE PLACE FOR REFERENCE. YOU HAVE 30 DAYS FROM THE DATE OF PURCHASE TO REGISTER YOUR ITEM.

PAGE 14 OF 14

COOL LIVING PRODUCT REGISTRATION CARD

NAME: _____

PHONE # _____ - _____ - _____ EMAIL: _____

ADDRESS: _____

CITY: _____ STATE: _____ ZIP CODE: _____ - _____

PRODUCT DESCRIPTION: _____

DATE OF PURCHASE: _____ PURCHASED FROM: _____

BRAND: _____ MODEL #: _____

SERIAL #: _____