

**ITEM NO.:A109000101**

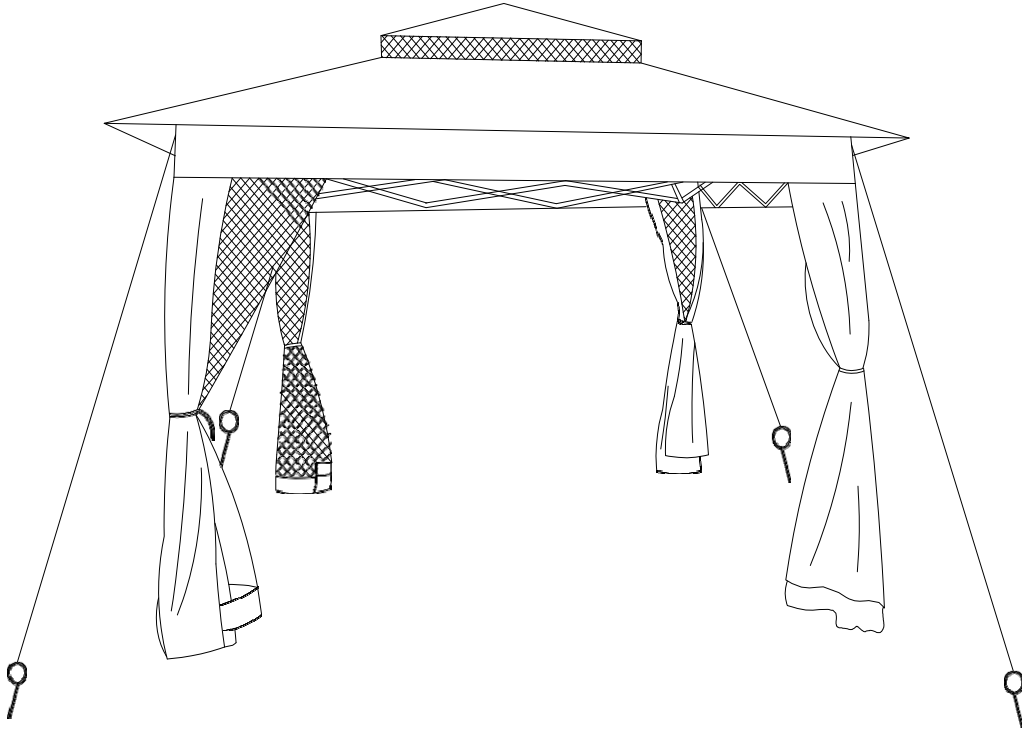

**WE HAVE YOU IN MIND, LET US SERVE YOU!**

Questions? Issues?  
**CONTACT US**  
24 hours / 7 days a week

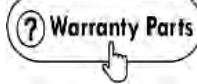

[www.sunjoyonline.com](http://www.sunjoyonline.com)



[customer.care@sunjoygroup.com](mailto:customer.care@sunjoygroup.com)



Country of Origin: China

## Parts List







Description	Part#	Label	Qty	Image
Gazebo frame	P005900008	A	1	
Connector	P000501049	B	4	
Small canopy	P001100570	C	1	
Large canopy	P001100571	D	1	
Mosquito netting	P001200222	E	1	
Stakes	H070010025	AA	8	
Large stakes	H070010017	BB	4	
Rope	P008300004	CC	4	
Netting rope	P008300005	DD	4	
Rings	P005100265	EE	34	
Bag	P007600073	FF	1	

Fig. 1

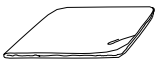
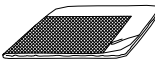
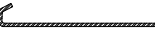
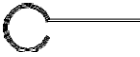

Step 1: Take out the gazebo (A) from the bag (FF).

Fig. 2

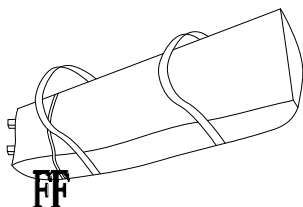
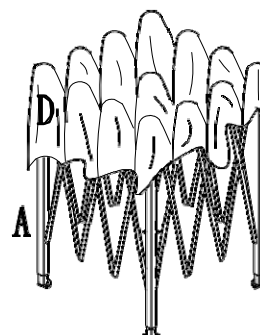

Step 2: Place the gazebo frame (A) upright and attach the large canopy (D) on top. Have four people holding the corner posts and pulling outwards.

Country of Origin: China

Fig. 3

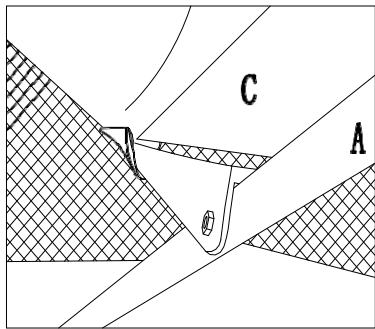

Step 3: Attach the Small canopy (C) to the plastic parts of the small top when pulling the gazebo outwards.

Fig. 4

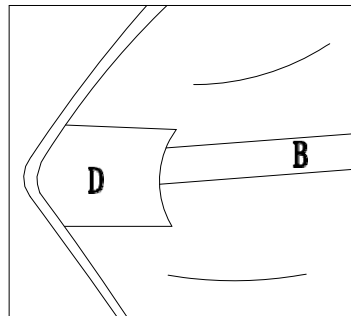
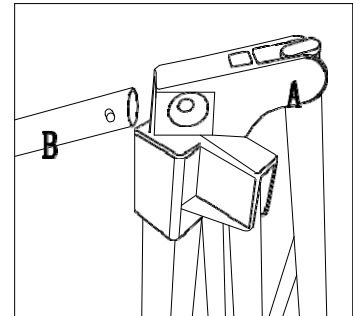
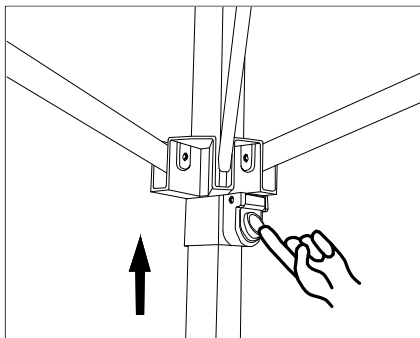

Fig. 4-1



Step 4: Secure the large canopy (D) to four corners by using connectors (B). Insert the other end of the connector (B) to the plastic buckle (A) and secure it to the spring buckle. Assemble the preassembled hook-and-loop fasteners.

Fig.5



Step 5: Pull the plastic buckle of the gazebo (A) post to the spring buckle and secure it.

Fig.6

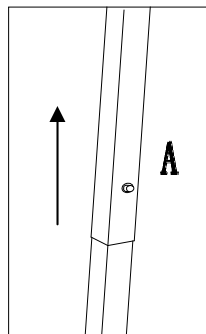

Step 6: Pull the gazebo post upwards to the spring buckle to secure in place.

Fig.7

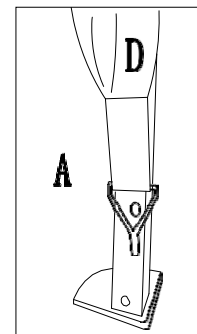

Step 7: Secure hooks on the large canopy (D) to the lower end of each post to tighten the large canopy.

Fig.8

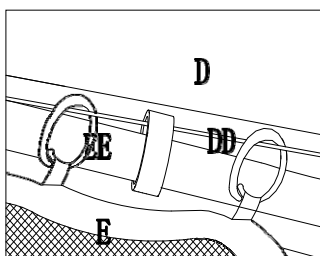

Step 8: Pass the netting rope (DD) through the loop on the large canopy (D) and tighten netting rope (DD) in place. Attach mosquito netting (E) to the netting rope by using rings (EE).

Fig.9

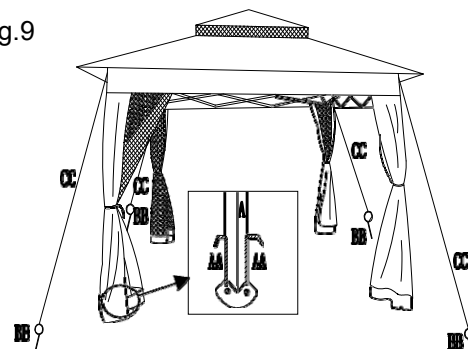

Step 9: Secure the gazebo to the ground by using stakes (AA) and ropes (CC); tighten ropes on the corners of the large canopy (D) and secure each rope with large stakes (BB).

## Care and Maintenance

- Our steel components for garden accessories and furniture are treated with rust inhibiting paint that protects it from rusting. However, due to the nature of steel, surface oxidation (rusting) will occur once these protective coatings are scratched. This is not a defect and thus not covered by the warranty.
- To minimize this condition, we recommend care when assembling & handling the product to prevent scratching the paint. Should any scratching or damage occur, we recommend immediate touch-up with rust inhibiting paint.
- Surface rust can also be easily removed with a very light application of common cooking oil. If surface oxidation (rusting) occurs and if no measure is taken to prevent this, the oxidation may start dripping on to deck or patio and caused damaging stains, which may be difficult to remove. This can be prevented if the above-mentioned measures are taken to keep the product from oxidizing.
- Use damp cloth to wipe off the stains as quickly as possible.
- If necessary, wash with a mild solution of soap and water; rinse thoroughly and dry completely.
- Periodically check and ensure that all bolts are well-tighten during use

## Limited Manufacturer's Warranty

Sunjoy Group warrants to the original purchaser that this item is free from defects in workmanship and materials for a period of 1 year from the date of purchase, provided the item was factory-sealed at the time of purchase and is maintained with care and used only for personal, residential purposes. Should any manufacturing defect arise within this warranty period, Sunjoy Group will replace (at our option) any defective merchandise or parts upon proof of purchase; however, transportation and delivery costs, as well as payments to a third party for assembly or disassembly of the item, remain the responsibility of the purchaser. A purchaser of an "open box," previously-returned, or "clearance" item, as well as original purchasers outside of the warranty period, may obtain replacement parts from Sunjoy Group for products in current production, at nominal cost.

## Exclusions:

Items used for commercial, contract, or other non-residential purposes, or items damaged due to acts of nature, vandalism, misuse, or improper assembly are not covered. Corrosion or rusting of hardware is not covered. Proof of purchase (dated register receipt) is required for warranty claims. Warranty is to the original purchaser and is non-transferable. Any replacement of warranted items will be in the original style and color, or a similar style and color if the original is unavailable or has been discontinued. As some states do not allow exclusions or limitations on an implied warranty, the above exclusions and limitations may not apply. This warranty gives you specific rights, and you may also have other rights, which vary from state to state.

Country of Origin: China