

**ASSEMBLY INSTRUCTION**  
**ITEM#: A103000105**

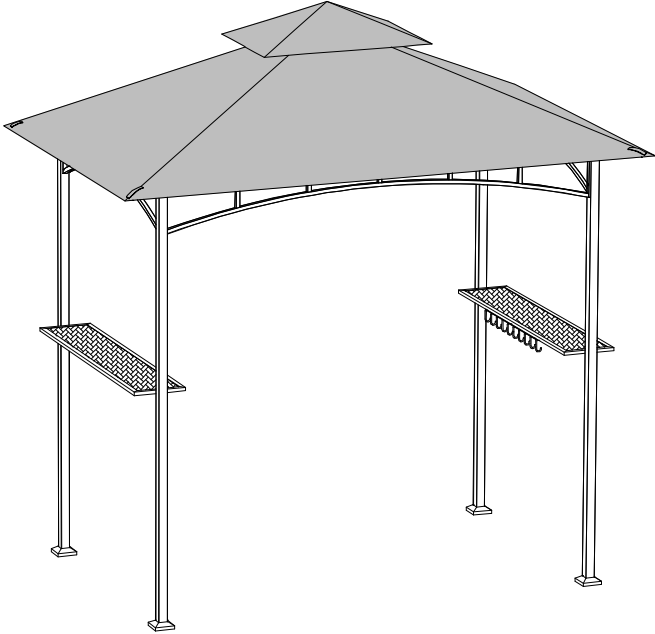

**WE HAVE YOU IN MIND, LET US SERVE YOU!**

Questions? Issues?

**CONTACT US**

24 hours / 7 days a week

 [www.sunjoyonline.com](http://www.sunjoyonline.com)

 [customer.care@sunjoygroup.com](mailto:customer.care@sunjoygroup.com)



## Safety Information

- One people are required for this assembly.
- Some parts may contain sharp edges. Wear protective gloves.
- When assembling and using this product, basic safety precautions should always be followed to reduce the risk of personal injury and damage to equipment. Please read all instructions before assembly and usage.



**CAUTION:** Chair is for setting purpose only. Standing on or misuse of chair may result in damage or injury. Not intended for commercial use. **WEIGHT LIMIT 250LBS(113.5KG)**

**NOTICE:** For outdoor use only.



### **WARNING:**

**Keep all children and pets away from assembly area.**

**Children and pets should be supervised when they are in the area of the Chair construction.**

**Keep assembly area at least 6 feet from any obstruction such as a fence, garage, house, overhanging branches, laundry line or electrical wires.**

**Check all bolts for tightness before use. IMPORTANT - check and tighten bolts often to keep them secure!**

## Warranty: 1 Year

### WHAT IS COVER?

The limited warranty is extended to the original purchaser and applies to material and manufacturer's defect provided the item is maintained with care and used only for personal, residential purposes.

## IMPORTANT





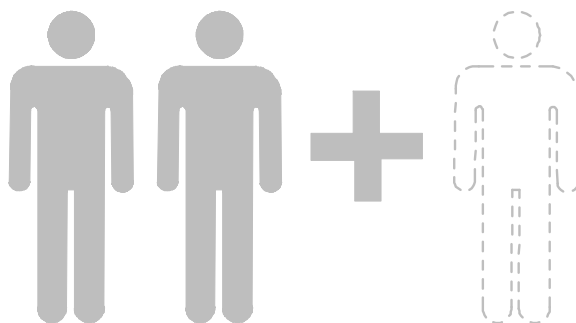



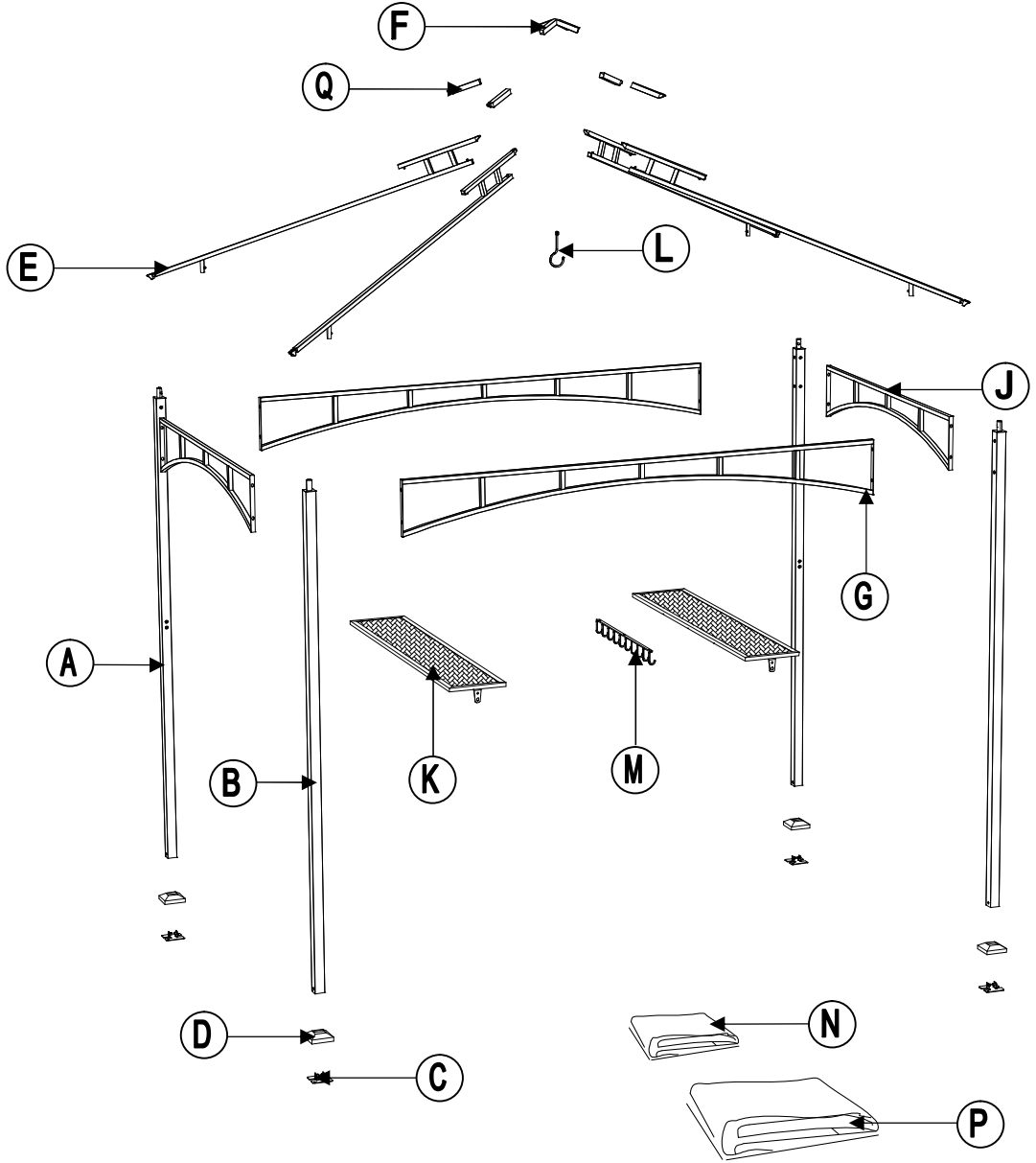

KEEP THIS INSTRUCTION MANUAL FOR FUTURE REFERENCE.

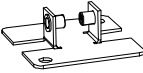
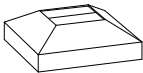
### How many people needed for the installation work

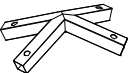

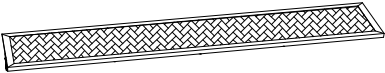
# EXPLODED DRAWING

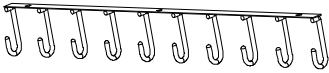

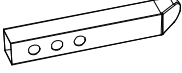
Parts List				
Label	Part Number	Description	Qty	Part Image
A	P000200076	Post 3	2	
B	P000200078	Post 4	2	
C	P000100293	Post Base	4	
D	P006100169	Base Cover	4	
E	P000600971	Big Roof Top Beam	4	
F	P000501025	Big Top Connector	1	
G	P000400796	Long Screen	2	
J	P000400797	Short Screen	2	
K	P002100285	Table Top	2	
L	P005800001	Hook	1	
M	P005800176	Hook Rack	1	
N	P001100587	Small Canopy	1	
P	P001100588	Big Canopy	1	
Q	P005700587	Adjustable Tube	4	

Country of Origin: China

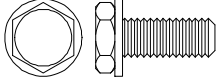
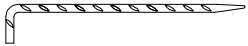
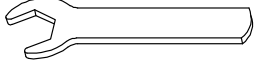
Hardware Pack					
Label	Part Number	Description	Qty	Add	Part Image
H1	H100010068	Bolt M6*15	35	2	
HS	H070010001	Stake Φ6	8	0	
HW	H090010017	Wrench M6	1	0	

# 1

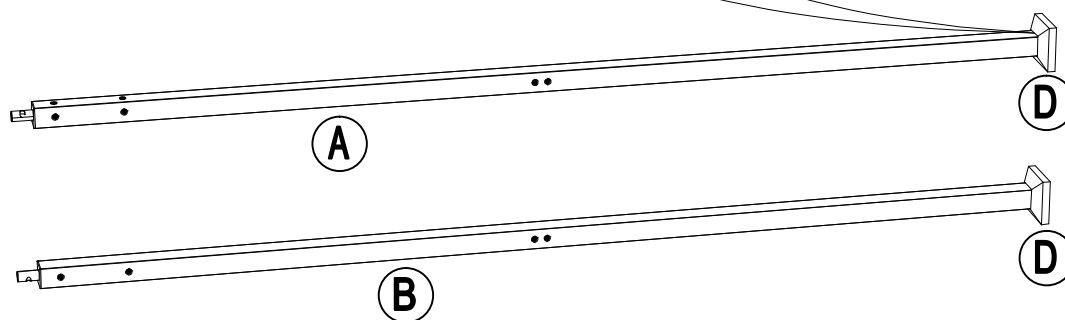
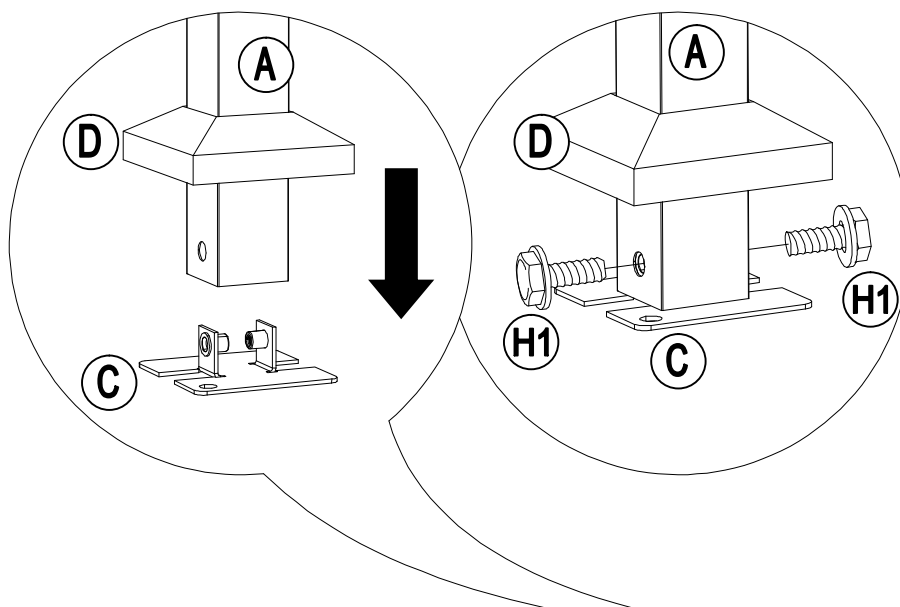
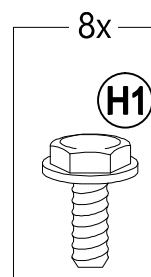
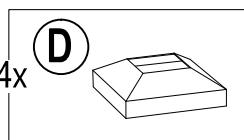
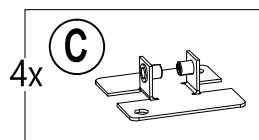
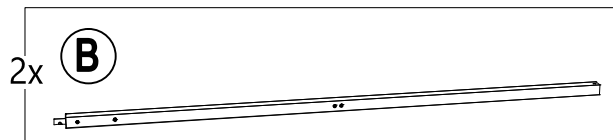
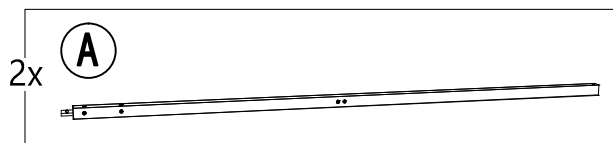

2

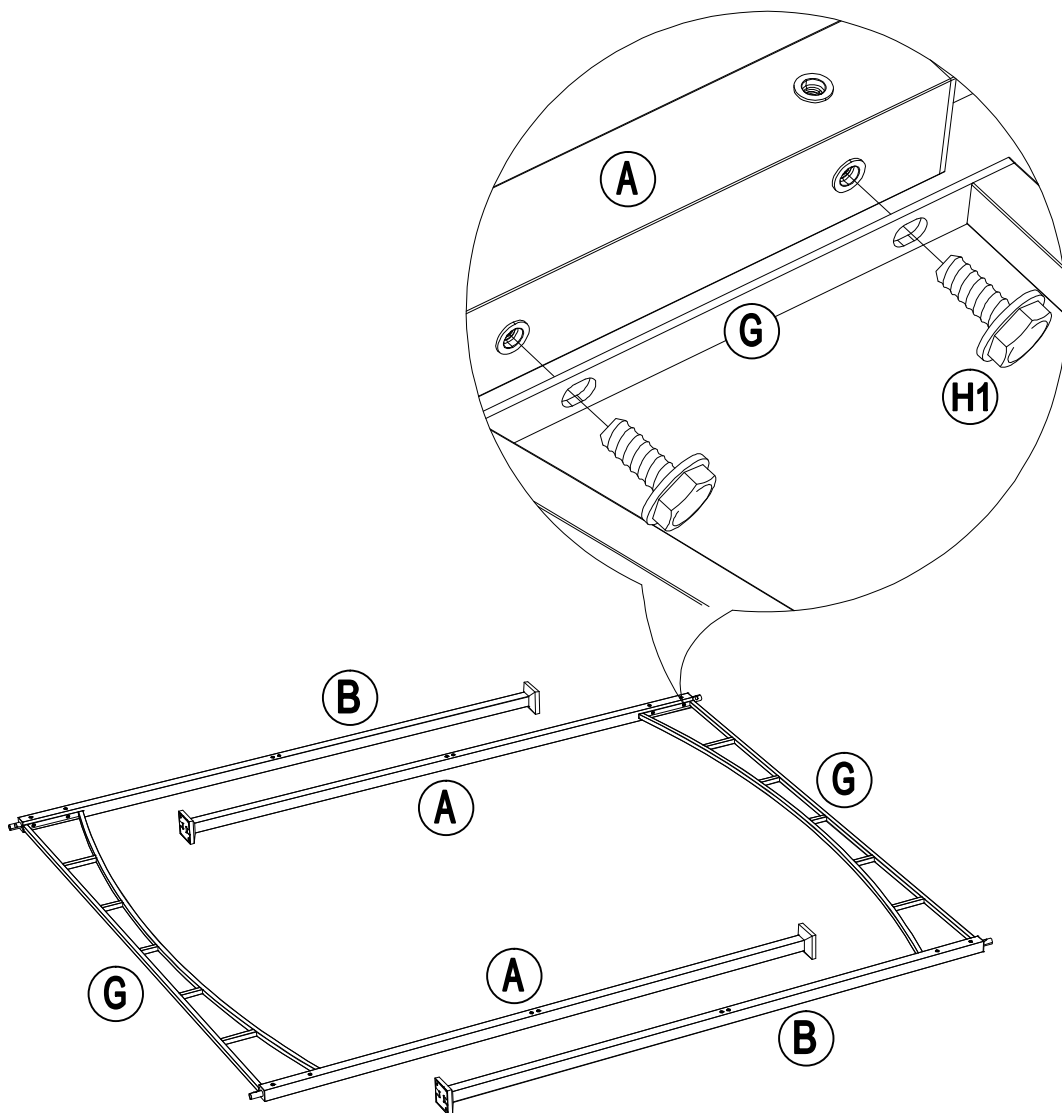
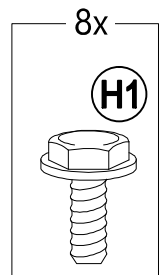
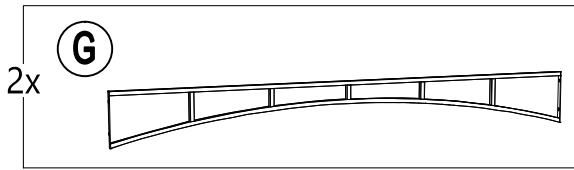

# 3

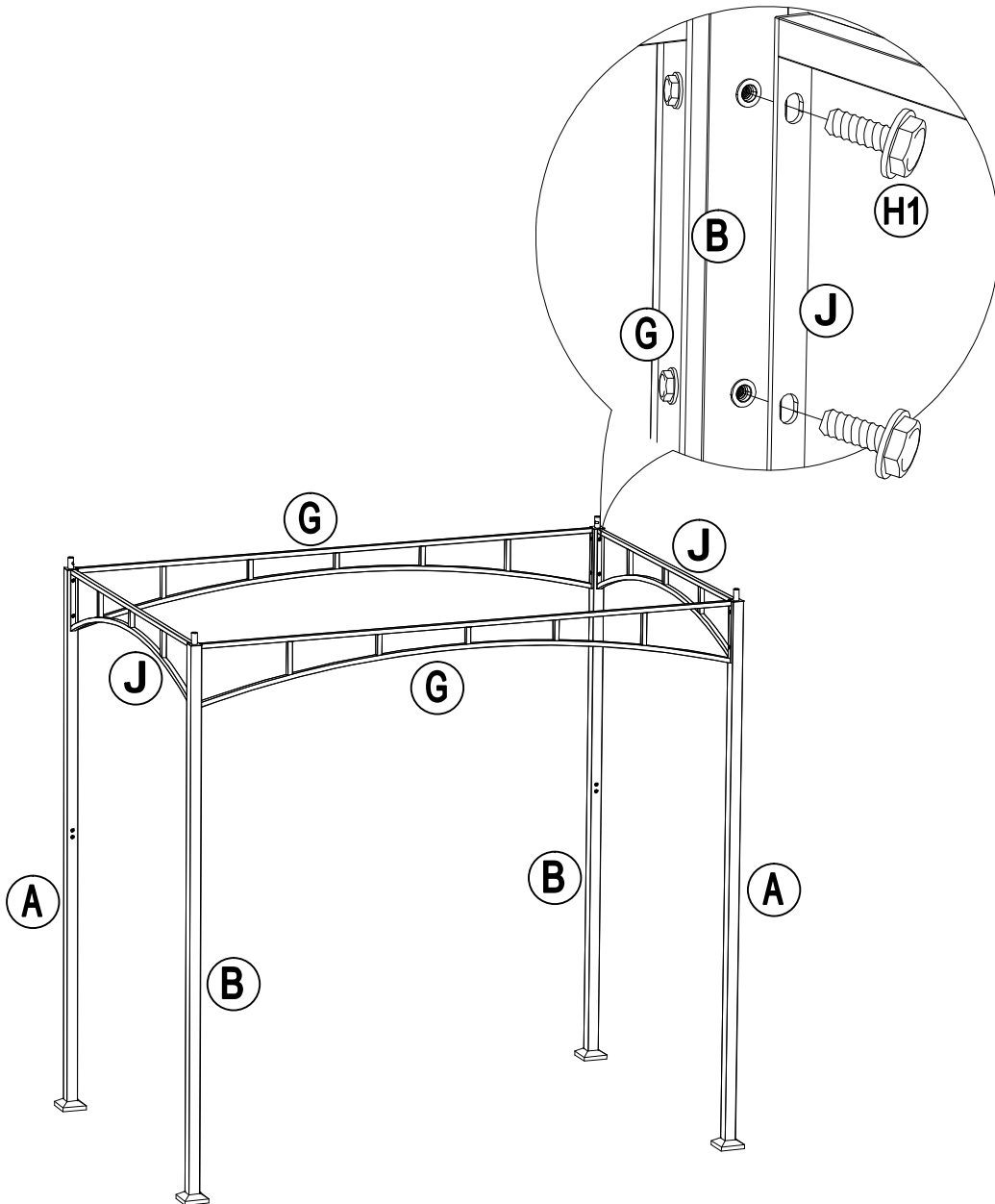
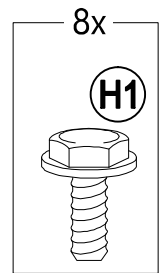
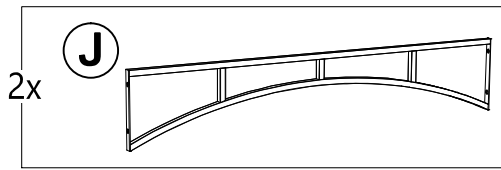



# 4

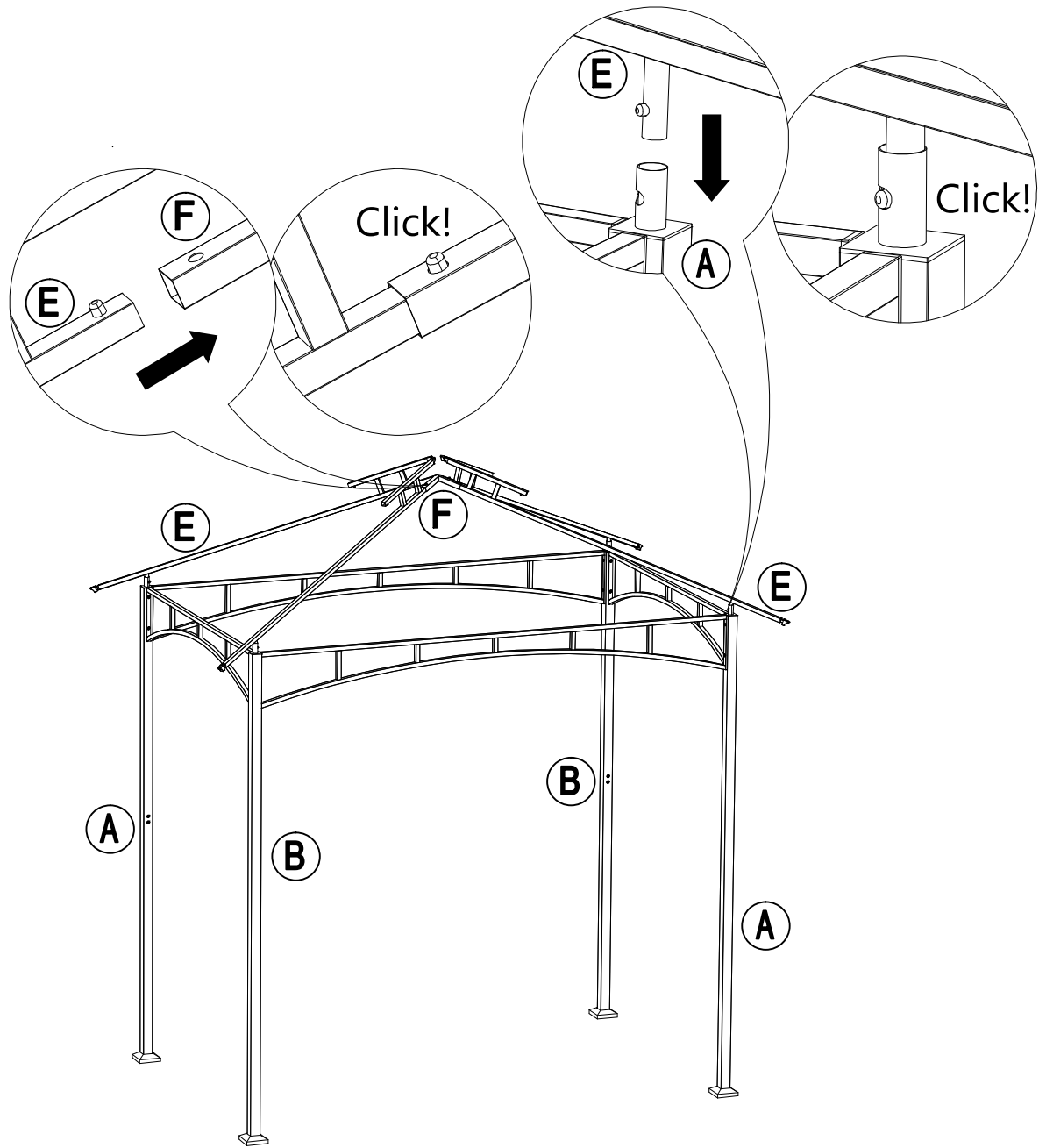
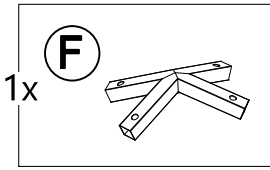
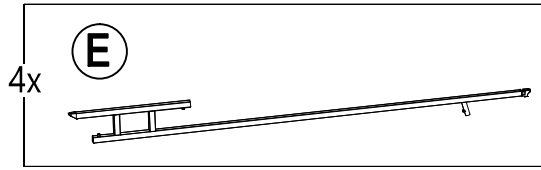

# 5

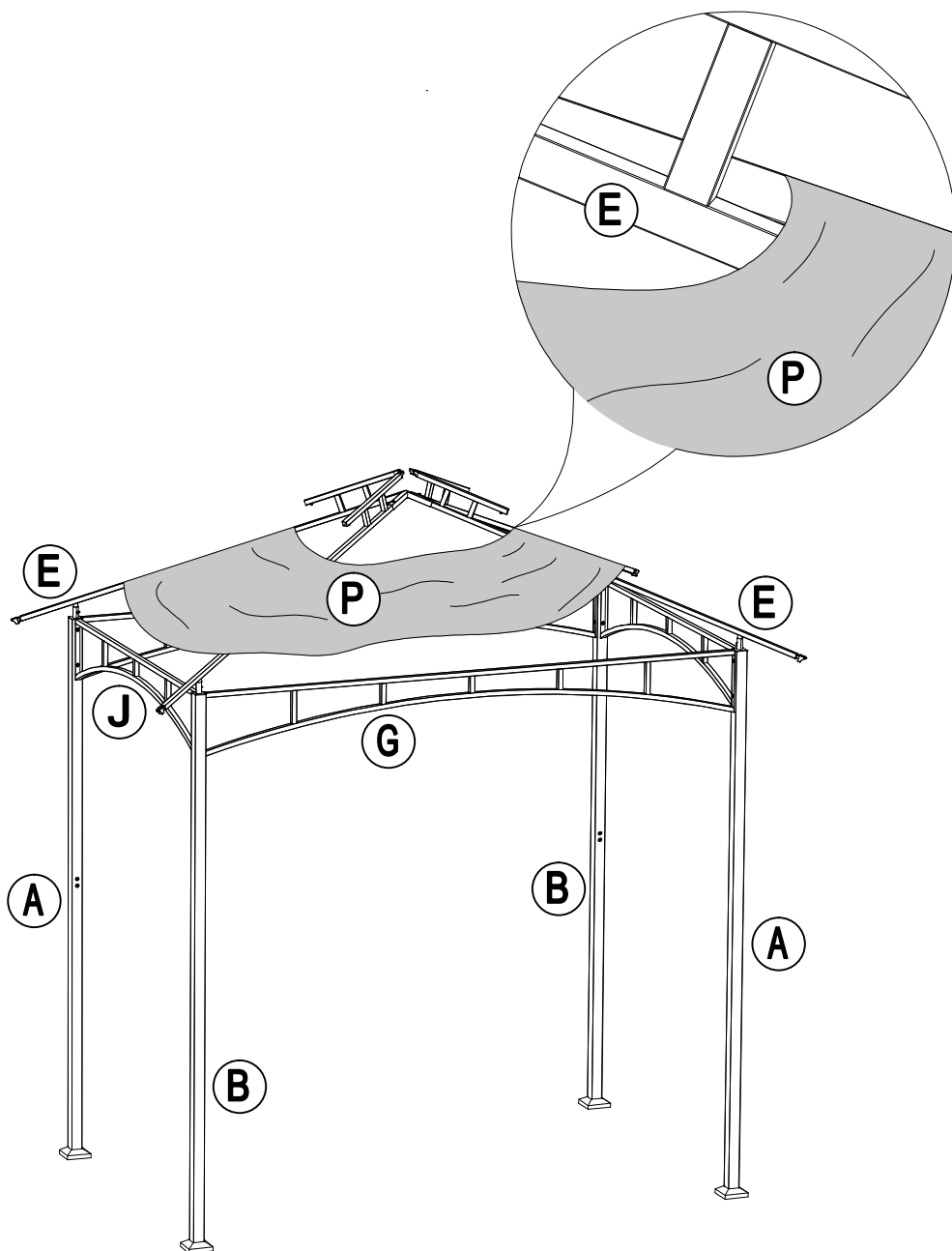
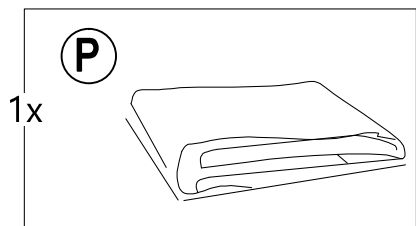

# 6

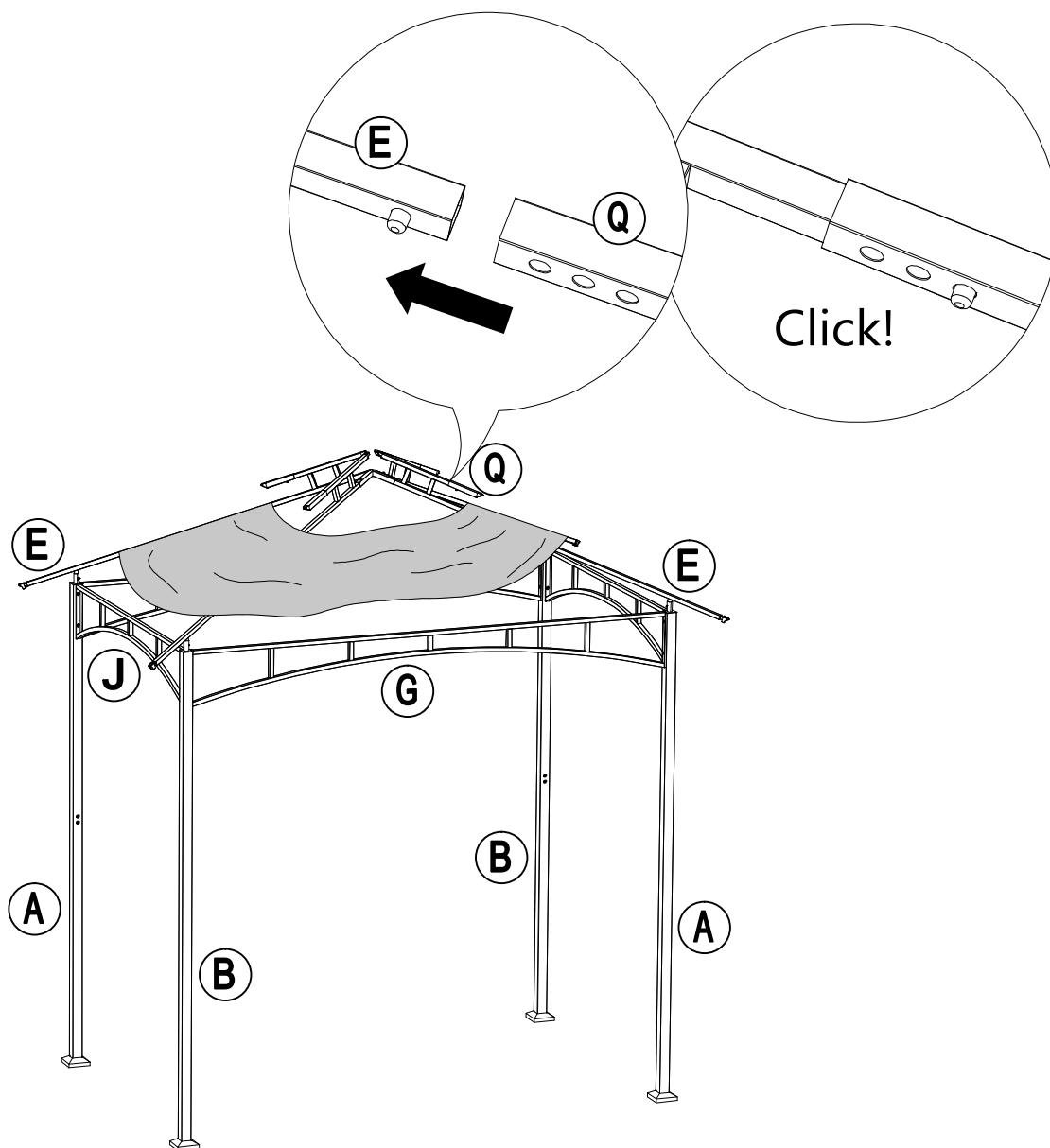
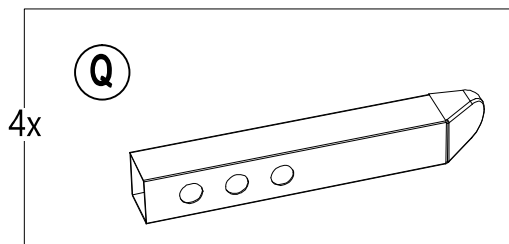

# 7

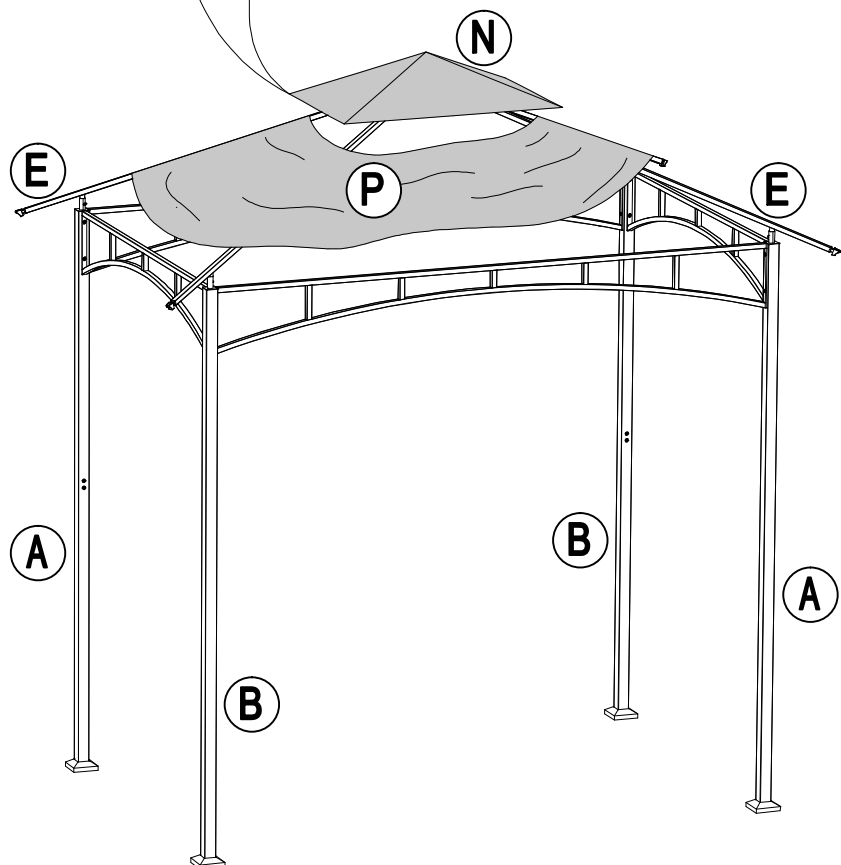
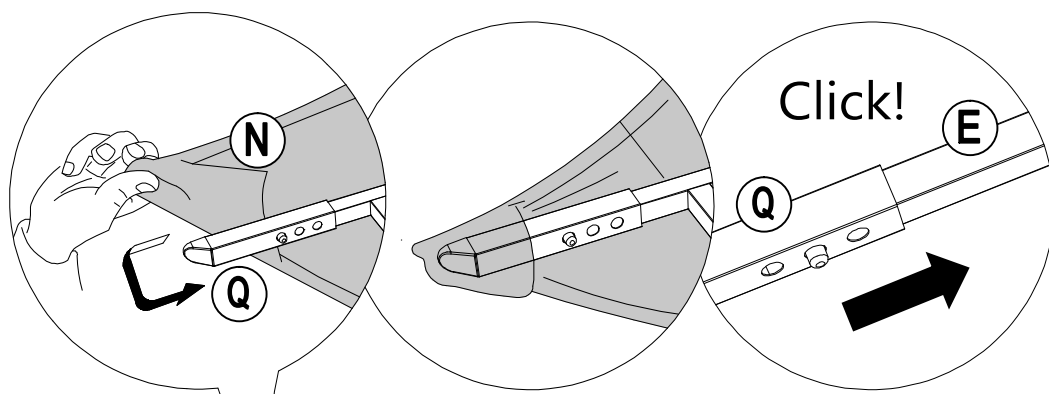
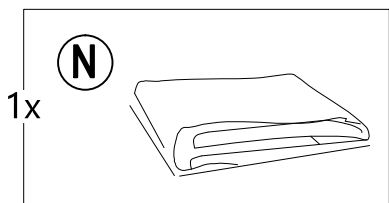

# 8

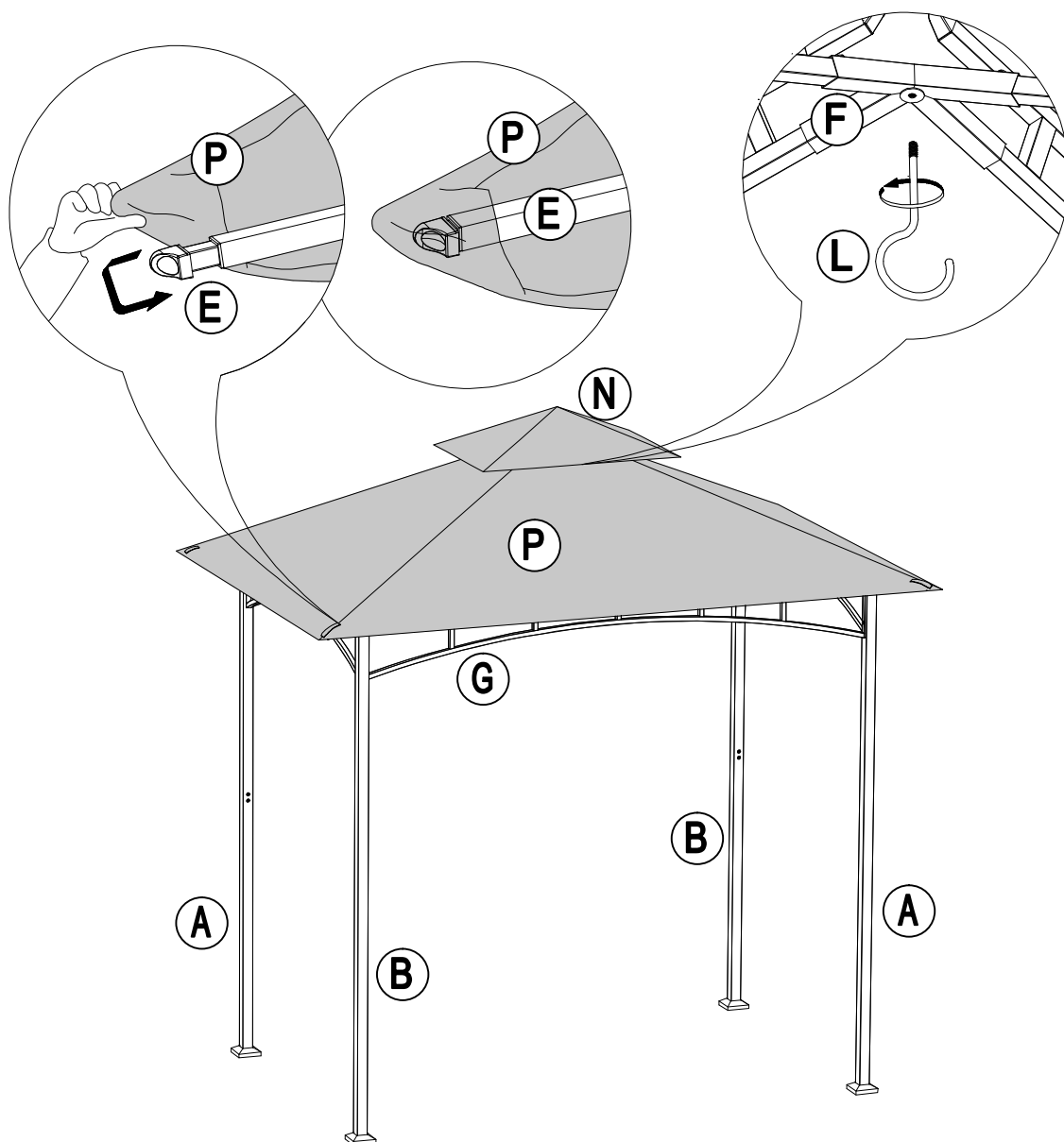
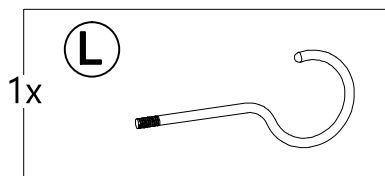

# 9

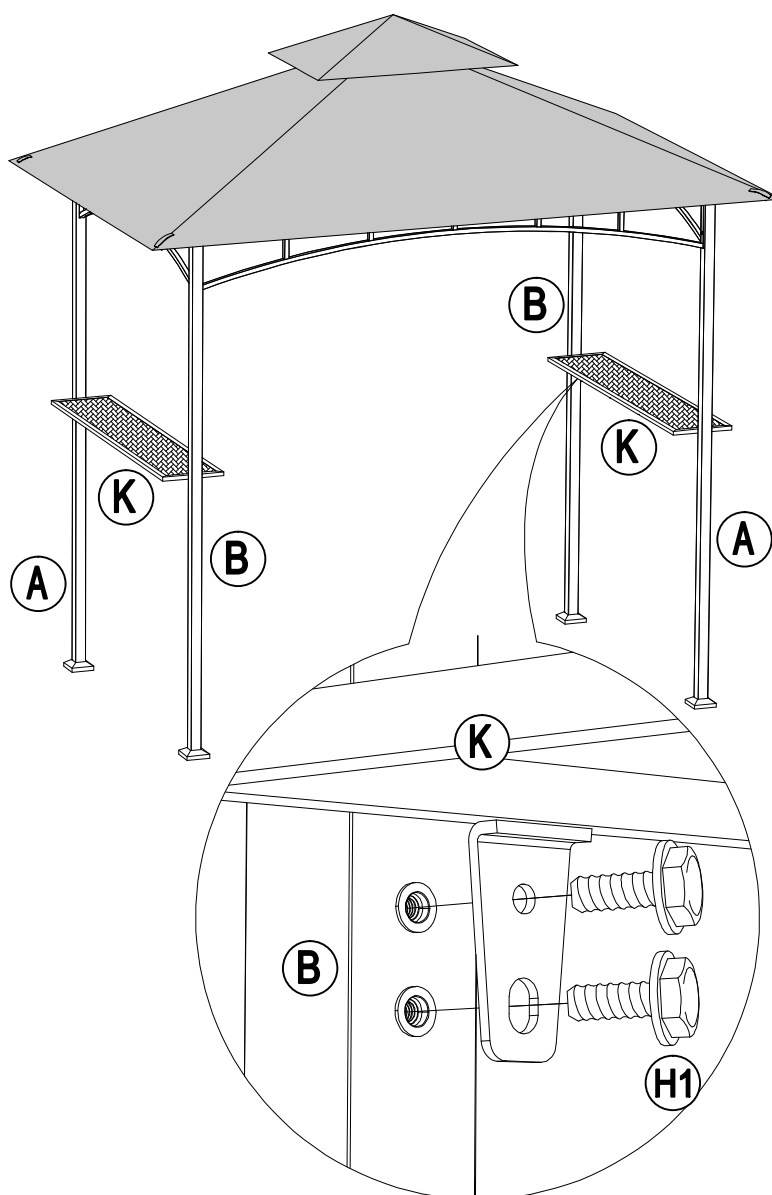
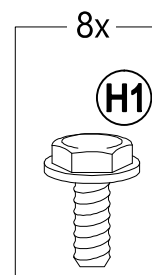
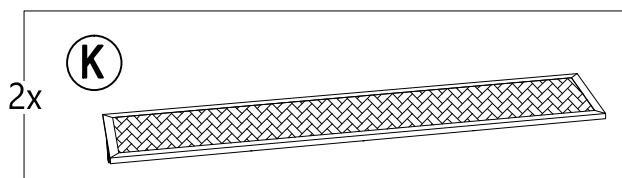

# 10

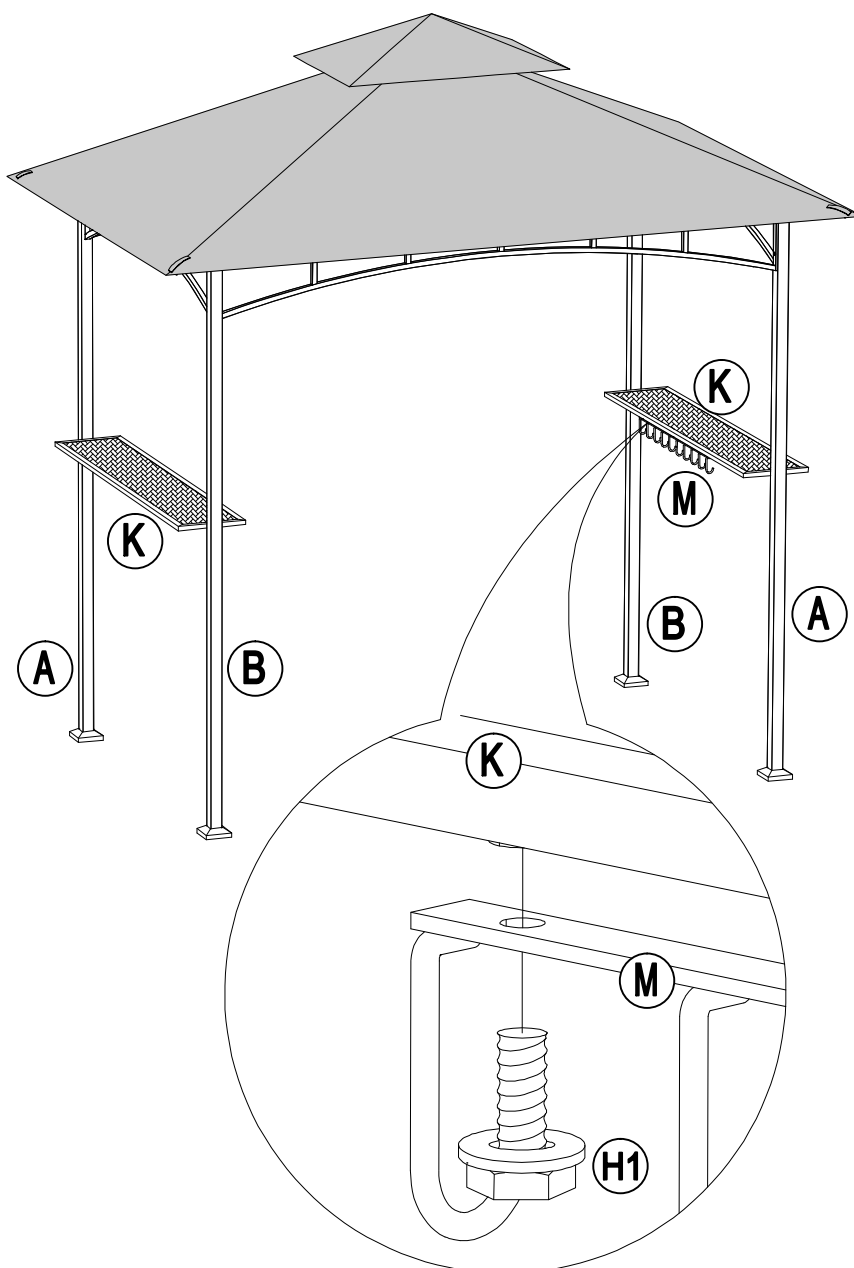
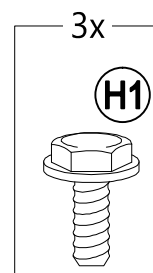
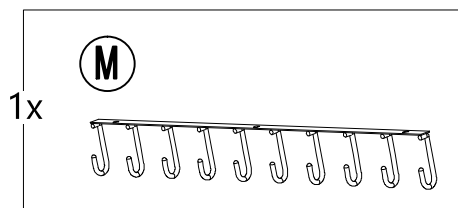





## Care and Maintenance

Before using, clean the Chair completely with a soft dry towel. When not in use, wipe free of any dirt or loose objects, wash with a mild solution of soap and water; rinse thoroughly and dry completely. Do not use strong detergent or abrasive cleaners. Over time nuts and bolts can loosen. Occasionally, check nuts and bolts, re-tighten if necessary.

## Limited Manufacturer's Warranty

SUNJOY Group warrants to the original purchaser that this item is free from defects in workmanship and materials for a period of 1 year from the date of purchase, provided the item was factory-sealed at the time of purchase and is maintained with care and used only for personal, residential purposes. Should any manufacturing defect arise within this warranty period, SUNJOY Group will replace (at our option) any defective merchandise or parts upon proof of purchase; however, transportation and delivery costs, as well as payments to a third party for assembly or disassembly of the item, remain the responsibility of the purchaser. A purchaser of an "open box," previously-returned, or "clearance" item, as well as original purchasers outside of the warranty period, may obtain replacement parts from SUNJOY Group for products in current production, at nominal cost.

## Exclusions

Items used for commercial, contract, or other non-residential purposes, or items damaged due to acts of nature, vandalism, misuse, or improper assembly are not covered. Corrosion or rusting of hardware is not covered. Proof of purchase (dated register receipt) is required for warranty claims. Warranty is to the original purchaser and is non-transferable. Any replacement of warranted items will be in the original style and color, or a similar style and color if the original is unavailable or has been discontinued. As some states do not allow exclusions or limitations on an implied warranty, the above exclusions and limitations may not apply. This warranty gives you specific rights, and you may also have other rights, which vary from state to state.