

# 10x12 Hardtop Gazebo / Pavillon De Jardin A Auvent Rigide

Item/Article #: A102030890

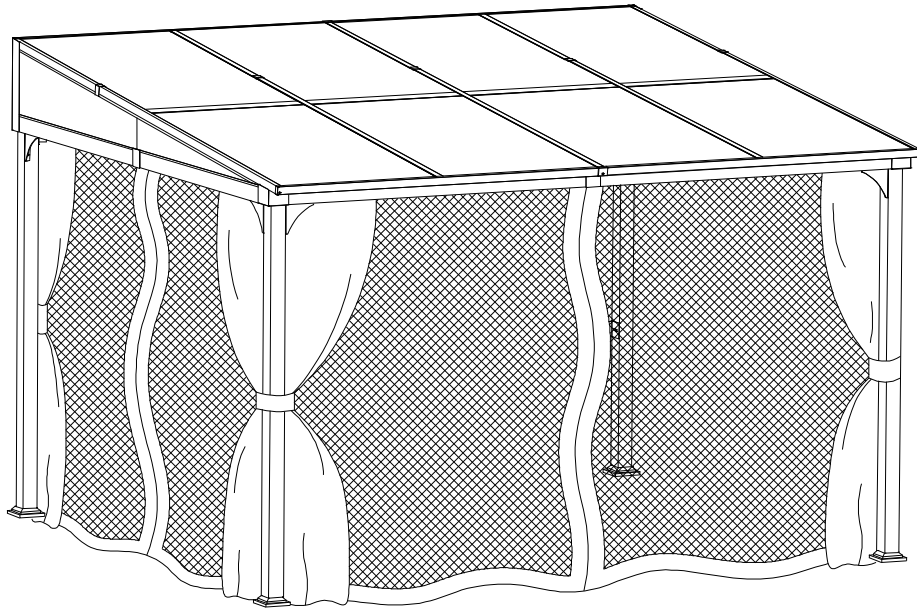

***Questions? Issues? Missing Part? Professional  
Installation Service?***

***Contact us at [customer.care@sunjoygroup.com](mailto:customer.care@sunjoygroup.com)***

***Questions? Problèmes? Pièce manquante?***

***Service d'installation professionnel? Contactez-  
nous à [customer.care@sunjoygroup.com](mailto:customer.care@sunjoygroup.com)***



A10203089024



Country of Origin: China  
Pais d'origine: Chine

Production Number: 2024BPCN10  
Numéro de fabrication: 2024BPCN10

## Warnings :

- Any assembly or maintenance of the product must be carried out by adults only. We recommend at least 4 adults. / Tout montage ou entretien du produit doit être effectué uniquement par des adultes. Nous recommandons au moins 4 adultes.
- Please check your state and local regulations prior to purchasing. Some jurisdictions may require permits for installation and use. Some special procedures may be valid in your area. / Veuillez vérifier les réglementations nationales et locales avant d'acheter. Certaines juridictions peuvent exiger des permis pour l'installation et l'utilisation. Certaines procédures spéciales peuvent être valides dans votre région.
- Do not assemble the gazebo on sandy, muddy or loose soil, as stakes do not have enough anchorage in these types of soil. / Ne montez pas la tonnelle sur un sol sablonneux, boueux ou meuble, car les piquets n'ont pas assez d'ancrage dans ces types de sol.
- Install the gazebo on level ground . Stakes are provided to secure the gazebo to the ground./ Installez le belvédère sur un sol plat. Des piquets sont fournis pour fixer la tonnelle au sol.
- If you wish to secure the gazebo to a wood deck or concrete surface, use anchors suited to these surfaces (anchors not included)./Si vous souhaitez fixer le gazebo à une terrasse en bois ou à une surface en béton,utilisez des ancrages adaptés à ces surfaces (ancrages non inclus).
- Some parts may contain sharp edges. Wearing protective gloves is advised. / Certaines pièces peuvent contenir des bords tranchants. Portez des gants de protection si nécessaire.
- Keep children and pets away while setting up the gazebo./Tenez les enfants et les animaux à l'écart de l'abri de jardin pendant son assemblage.
- Check all nuts and bolts periodically to ensure they are tightened./ Assurez-vous périodiquement que tous les écrous et boulons pour s'assurer que les ils sont serrés.
- Snow must be cleared off regularly during snowy days. Remove the snow at the roof top when it is thicker than 2 inches. In order to avoid damage, use a plastic snow rake to remove excessive snow and ice buildup from roof and keep away from falling debris. and removal of fallen debris. /La neige doit être déblayée régulièrement pendant les jours de neige. Enlevez la neige sur le toit lorsqu'elle est plus épaisse que 2 pouces. Afin d'éviter tout dommage, utilisez un râteau à neige en plastique pour enlever l'accumulation excessive de neige et de glace sur le toit et éloignez-vous des chutes de débris. et l'enlèvement des débris tombés.
- This gazebo is intended for decorative and sunshade purposes only and is not designed to withstand harsh weather, including high winds, rain, and snow. / Cet abri de jardin est conçu uniquement pour des fins décoratives et de pare-soleil, et il n'est pas conçu pour résister aux intempéries, notamment les vents violents, la pluie et la neige.
- If any scratches in paint occur, please touch up to prevent rustin / En cas de rayures sur la peinture, veuillez les retoucher pour éviter la rouille.

## Important:

- Please read and understand this manual before any assembly. Before beginning assembly of product, make sure all parts are present. Compare parts with packaging contents list.
  - When assembling wooden parts, do not overtorque the bolts to avoid splitting the wood. See image illustration.
  - Place all parts from the box in a cleared area and position them on the floor in front of you.
  - Remove all packing materials and place them back into the box. Do not dispose of the packing materials until assembly is complete.
  - Read each step carefully before beginning any assembly and make sure you understand each step. If you are missing a part, please email [customer.care@sunjoygroup.com](mailto:customer.care@sunjoygroup.com).
  - Needed for assembly: (The following tools are not included)
- Veuillez lire et bien comprendre ce guide avant de procéder à l'assemblage. Avant de procéder à l'assemblage du produit, assurez-vous que toutes les pièces sont présentes.
  - Lors de l'assemblage de pièces en bois, ne serrez pas trop les boulons afin d'éviter de fendre le bois.
  - Consultez l'illustration dans les schémas. Mettez toutes les pièces de la boîte dans une zone dégagée et positionnez-les sur le sol devant vous.
  - Retirez tous les matériels d'emballage et remettez-les dans la boîte. Ne les jetez pas avant d'avoir terminé l'assemblage.
  - Lisez chaque étape attentivement avant de commencer à assembler et assurez-vous de comprendre bien chaque étape. S'il vous manque des pièces, veuillez envoyer un email à [customer.care@sunjoygroup.com](mailto:customer.care@sunjoygroup.com).
  - Nécessaire pour l'assemblage : (les outils suivants ne sont pas inclus).

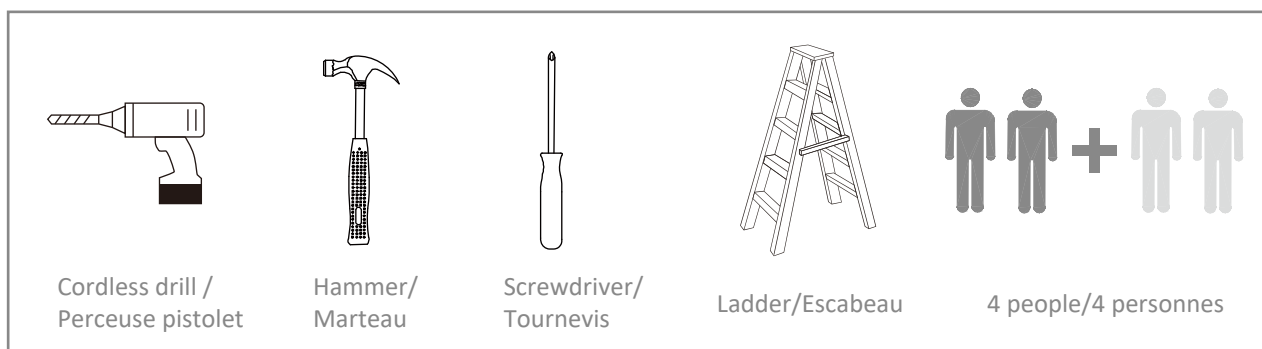

This identifies information that requires special attention. Improper assembly could lead to an unsafe or dangerous condition. / Cette icône identifie de l'information. Utilisez un niveau. Vérifiez avec un équerre. Serrez les boulons. Mesurer la distance.



### Use Level/Utilisez un niveau

Check that set or assembly is properly level before proceeding. / Vérifiez que l'assemblage est d'aplomb avant de procéder à la prochaine étape.



### Square Assembly/Vérifiez avec un équerre

Check that assembly is square before tightening bolts. / Vérifiez que l'assemblage est carré avant de serrer les boulons.



### Tighten Bolts/Serrer les boulons

Do not overtorque mounting bolts. Over-tightening may cause the wood to crack creating splinters and other structural damage. / Ne serrez pas trop les boulons de fixation. Un serrage excessif peut provoquer des fissures dans le bois, créant des éclats de bois et d'autres dommages structurels.



### Measure Distance/Mesurer la distance

Installation blueprint/  
Plan d'installation

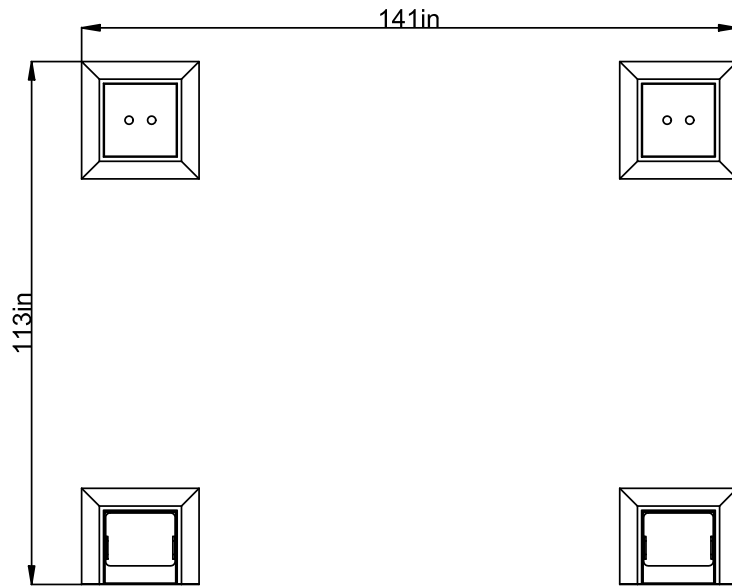



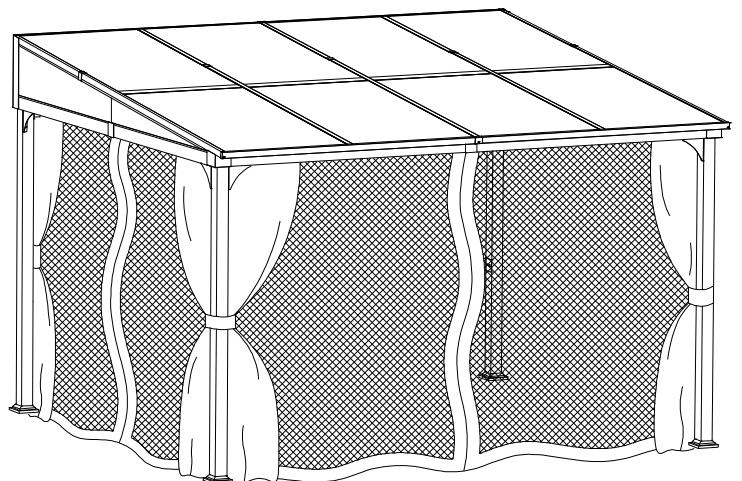
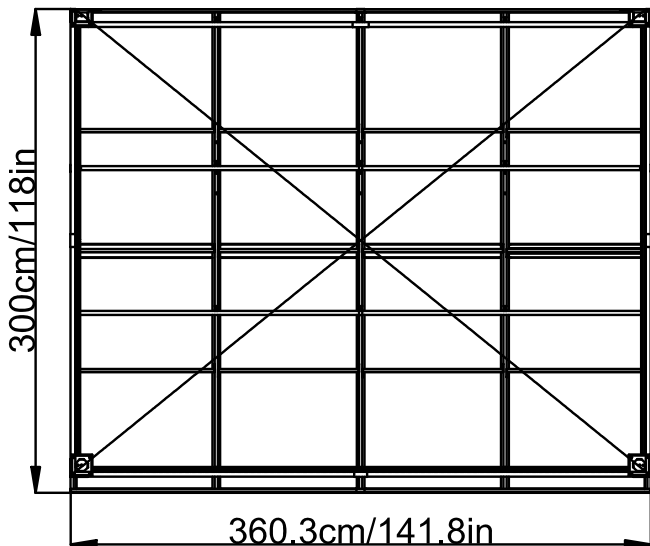
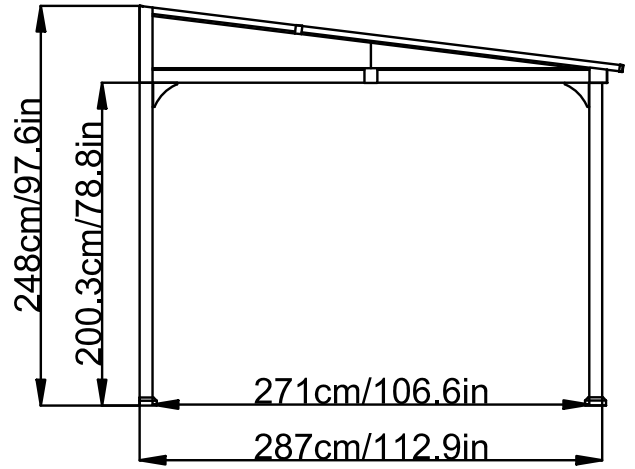
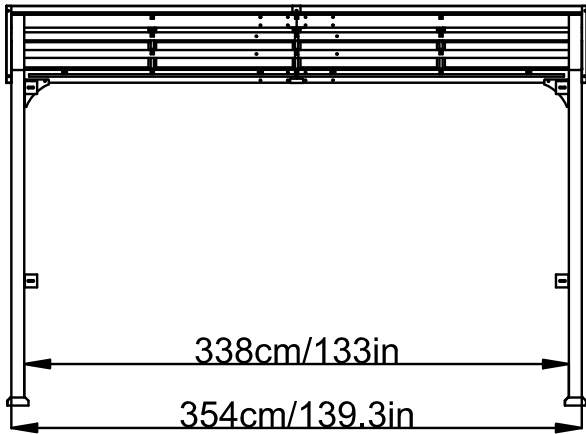



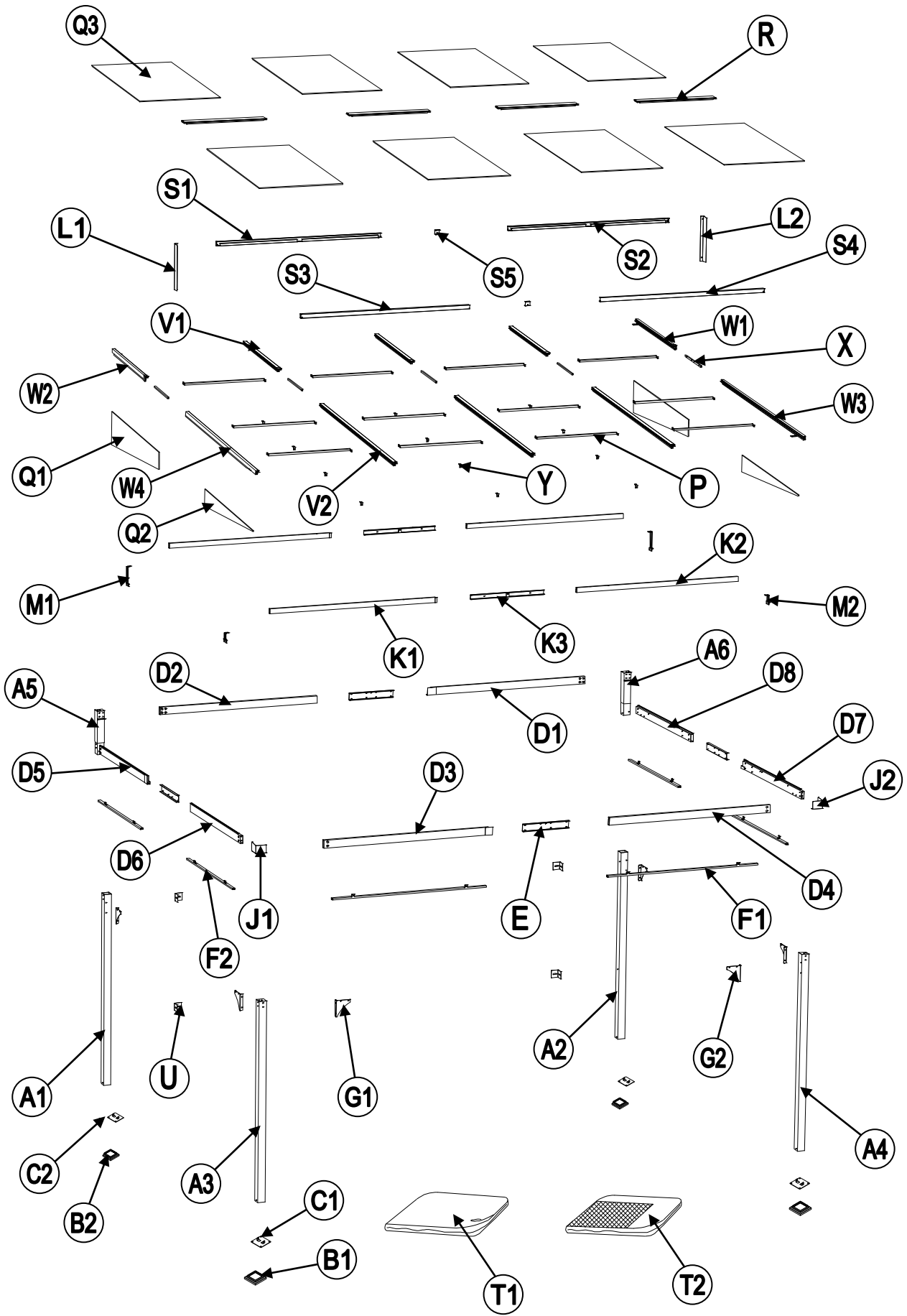













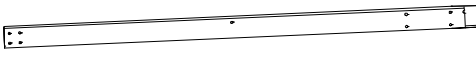



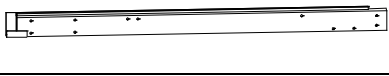











Product size effect drawing/  
Dessin d'effet de taille de produit















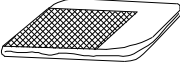

**EXPLODED DRAWING/ DESSIN ÉCLATÉ**







Parts List/Liste de Pièces				
Label/ Étiquette	Part Number/ Numéro de la Pièce	Description	Qty/ Quantité	Part Image/Numéro de la Pièce Diagramme
A1	P00020093401	Post 1/Poteau 1	1	
A2	P00020093501	Post 2/Poteau 2	1	
A3	P00020093701	Post 4/Poteau 4	1	
A4	P00020093601	Post 3/Poteau 3	1	
A5	P00020093901	Post 6/Poteau 6	1	
A6	P00020093801	Post 5/Poteau 5	1	
B1	P00610012401	Base Cover 1/Barde de la base 1	2	
B2	P00610012501	Base Cover 2/Barde de la base 2	2	
C1	P00010057801	Post Base 1/Base du Poteau 1	2	
C2	P00010057901	Post Base 2/Base du Poteau 2	2	
D1	P00040174301	Left Cross Beam 1/ Traverse gauche 1	1	
D2	P00040174401	Right Cross Beam 1/ Traverse Droite 1	1	
D3	P00040174501	Left Cross Beam 2/ Traverse gauche 2	1	
D4	P00040174601	Right Cross Beam 2/ Traverse Droite 2	1	
D5	P00040174701	Left Cross Beam (Left Side)/Traverse gauche(Côté gauche)	1	
D6	P00040174801	Right Cross Beam(Left Side)/Traverse Droite(Côté gauche)	1	
D7	P00040174901	Left Cross Beam(Right side) /Traverse gauche(Côté droit)	1	
D8	P00040175001	Right Cross Beam(Right side) / Traverse Droite(Côté droit)	1	

E	P00050222001	Cross Beam Connector / Connexion de la Traverse	4	
F1	P00570045301	Mosquito Netting Rod 1/Tringle du Filet Moustiquaire 1	2	
F2	P00570045401	Mosquito Netting Rod 2/Tringle du Filet Moustiquaire 1	4	
G1	P00500092801	Brace 1/Barre de Renfort 1	3	
G2	P00500092901	Brace 2/Barre de Renfort 2	3	
J1	P00220048601	Corner Cover Plate 1/ Plaque de recouvrement d'angle 1	1	
J2	P00220048701	Corner Cover Plate 2/ Plaque de recouvrement d'angle 2	1	
K1	P00500093001	Support Beam 1/ Poutre de Support 1	2	
K2	P00500093101	Support Beam 2/ Poutre de Support 2	2	
K3	P00050227201	Brace Connector 1/ Connexion de la Contrefiche 1	2	
L1	P00560059501	L Shape Decorative Panel 1/Panneau décoratif en forme de L 1	1	
L2	P00560059601	L Shape Decorative Panel 2/Panneau décoratif en forme de L 2	1	
M1	P00500093201	Brace 3/Barre de Renfort 3	2	
M2	P00500093301	Brace 4/Barre de Renfort 4	2	
P	P00060306001	Top Small Beam/Poutre Petite Supérieure	12	
Q1	P00070150901	PC Roof Panel 1/ Panneau de toit PC 1	2	
Q2	P00070152601	PC Roof Panel 2/ Panneau de toit PC 2	2	
Q3	P00070152801	PC Roof Panel 3/ Panneau de toit PC 3	8	
R	P00220048801	Slot/Fente	4	

S1	P00560059701	Decorative Panel 1/ Panneau Ornemental 1	2	
S2	P00560059801	Decorative Panel 2/ Panneau Ornemental 2	2	
S5	P00560060101	Decorative Panel 5/ Panneau Ornemental 5	2	
T1	P00130016501	Curtain/Rideau	1	
T2	P00120032301	Mosquito Netting/ Filet moustiquaire	1	
U	P00220048901	Stator/Stator	4	
V1	P00060312501	Short Middle Beam/ Poutre Courte Centrale	3	
V2	P00060312601	Long Middle Beam/ Poutre Longue Centrale	3	
W1	P00060312701	Short Side Beam (Right side)/Faisceau latéral court(côté droit)	1	
W2	P00060312801	Short Side Beam (left side) /Faisceau latéral court(côté gauche)	1	
W3	P00060312901	Long Side Beam(Right side) /Poutre latérale longue (côté droit)	1	
W4	P00060313001	Long Side Beam(left side) /Poutre latérale longue(côté gauche)	1	
X	P00050227301	Connector / Connecteur	5	
Y	P00050227401	Middle beam connector/ Connexion de la poutre centrale	12	

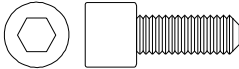
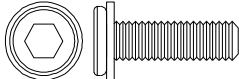

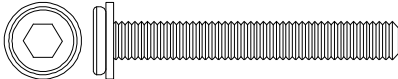
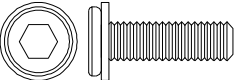
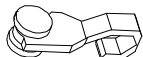
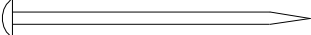
## Hardware Pack/Pack Quincaillerie

Label/ Étiquette	Part Number/ Numéro de la Pièce	Description	Qty/ Quantité	Add	Part Image/Numéro de la Pièce Diagramme
H1	H010170001	Bolt M6*15 Boulon M6*15	12	1	
H2	H100010050	Bolt M6*20/ Boulon M6*20	173	9	
H3	H010100002	Expansion Bolt Φ6*80/Boulon d'expansion Φ6*80	4	0	
H4	H090990002	M3 Drill/ Foret M3	1	0	
H5	H100010101	Bolt M6*45/ Boulon M6*45	8	0	
H6	H100010090	Bolt M6*15/ Boulon M6*15	8	0	
HR	H990050006	Ring with Wheels /Anneau avec Roues	88	5	
HS	H070010003	Stake Φ8*180 Piquet Φ8*180	8	0	
HW	H090030002	Allen Key M6 Clé Allen M6	2	0	

# 1

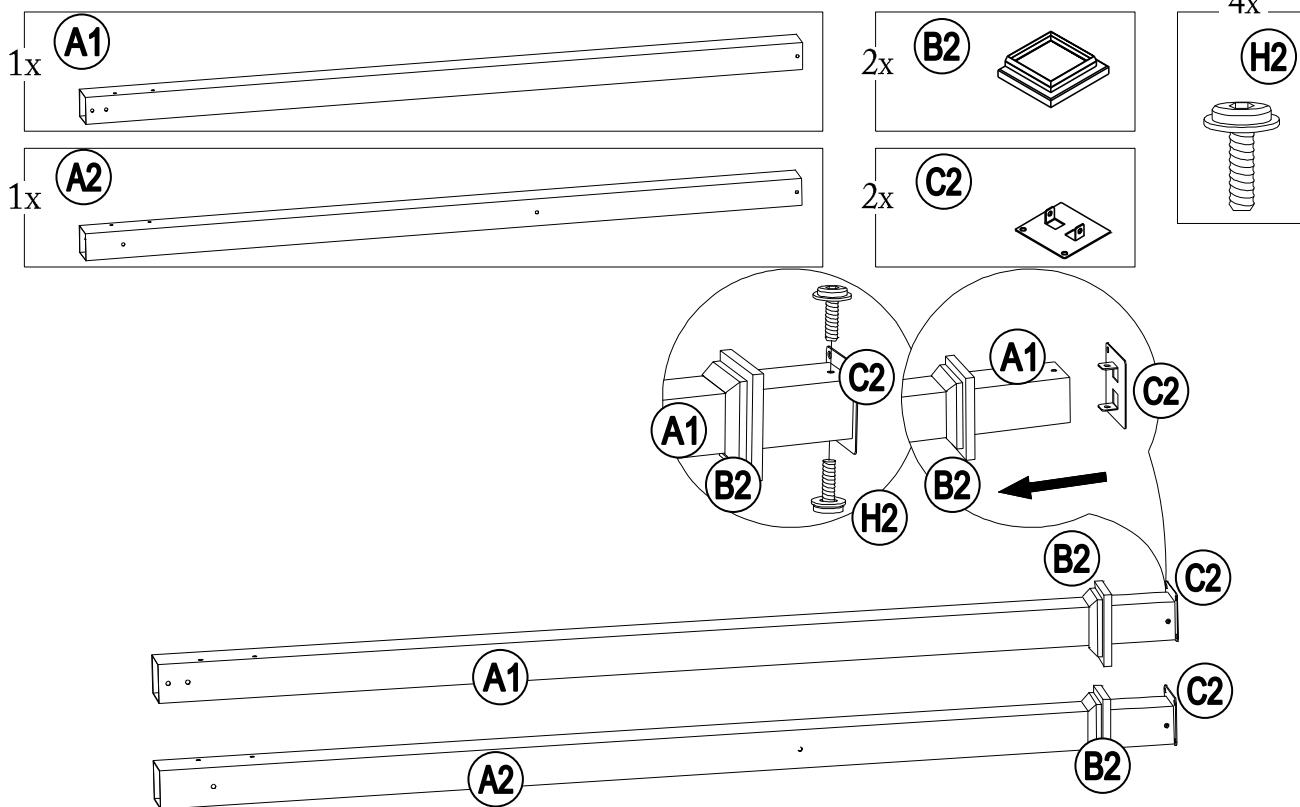

# 2

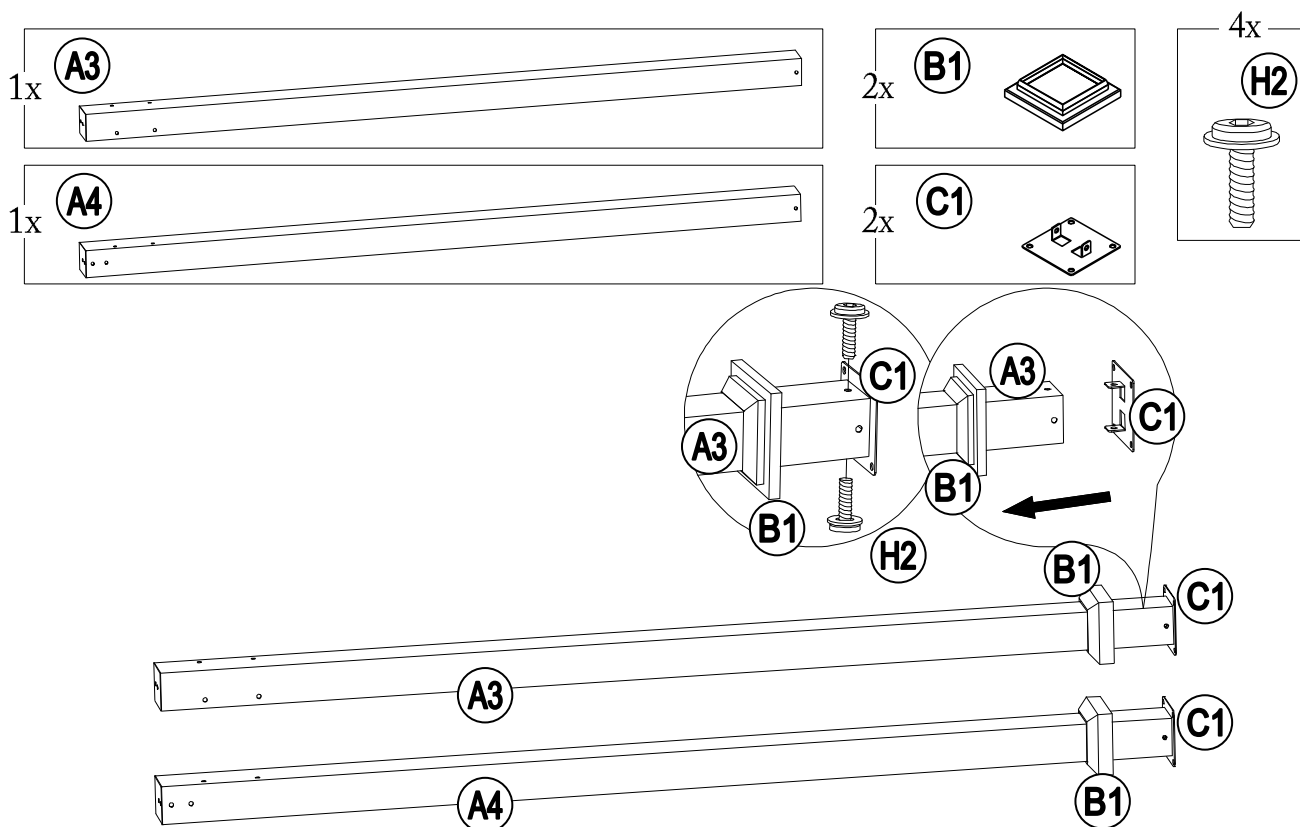

# 3

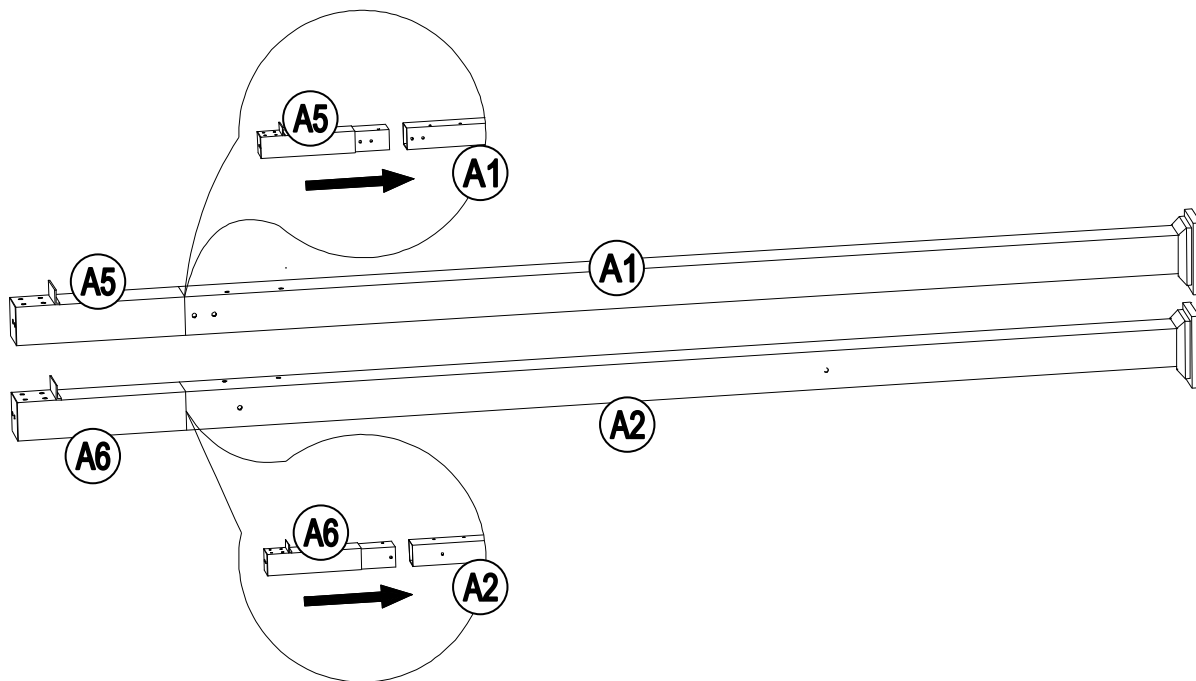
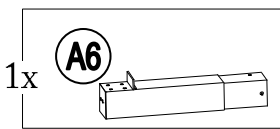
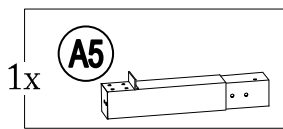

# 4

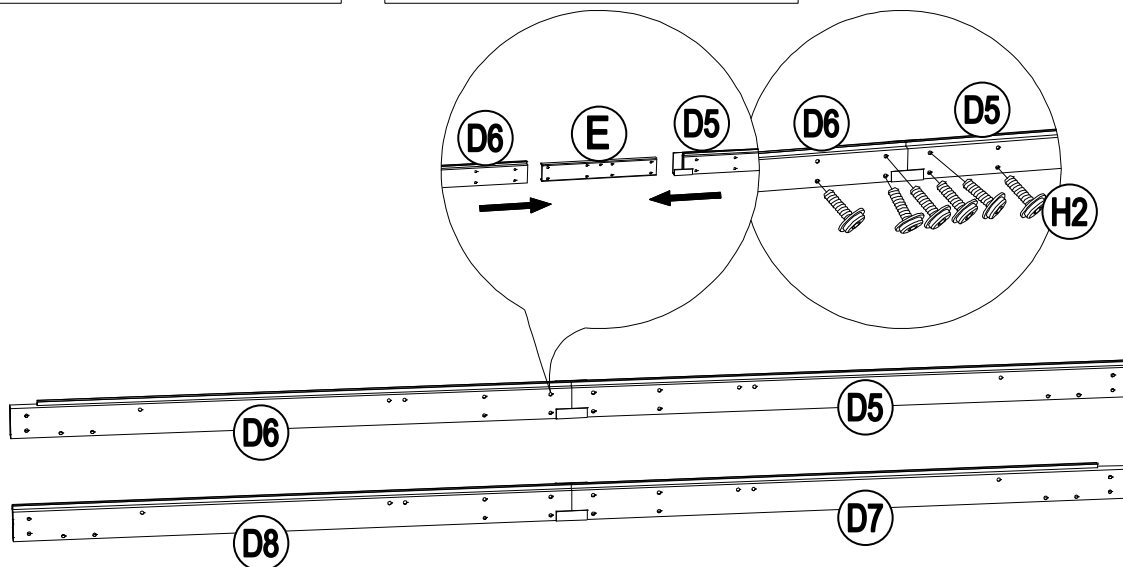
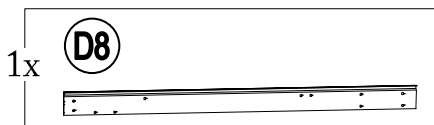
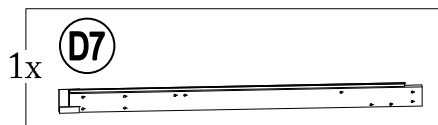
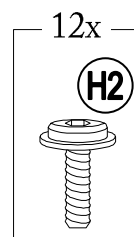
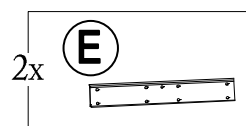
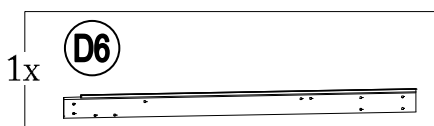
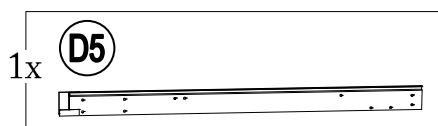

# 5

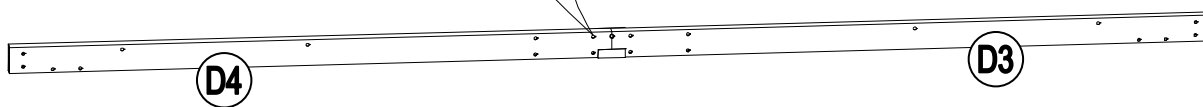
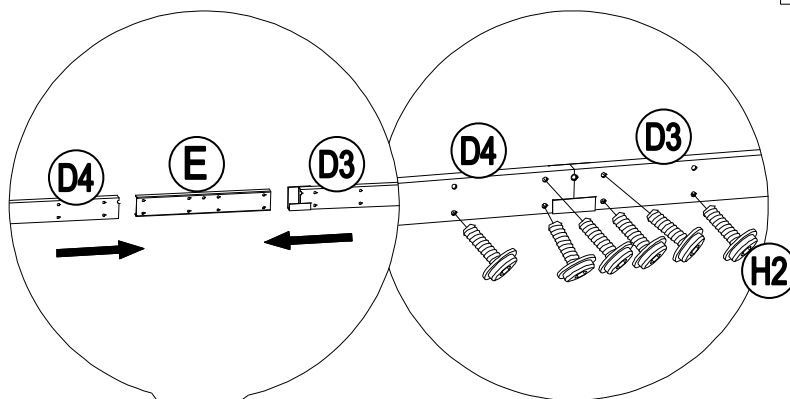
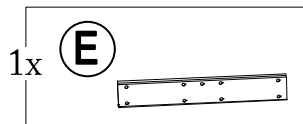
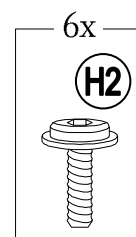
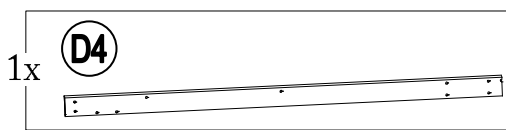
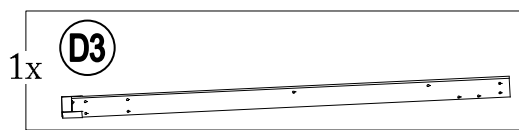

# 6

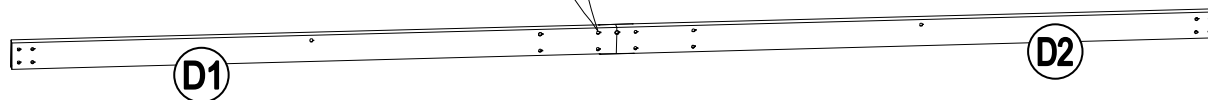
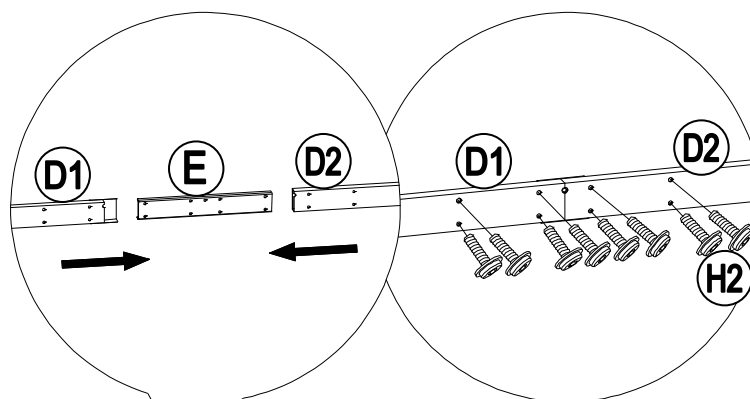
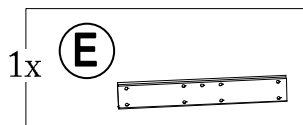
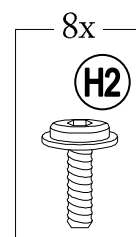
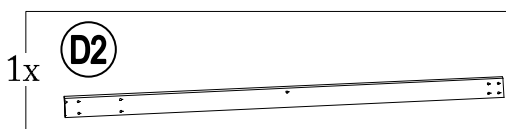
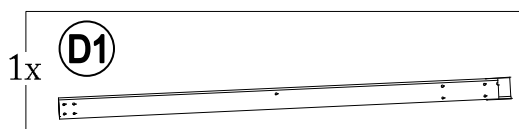

# 7

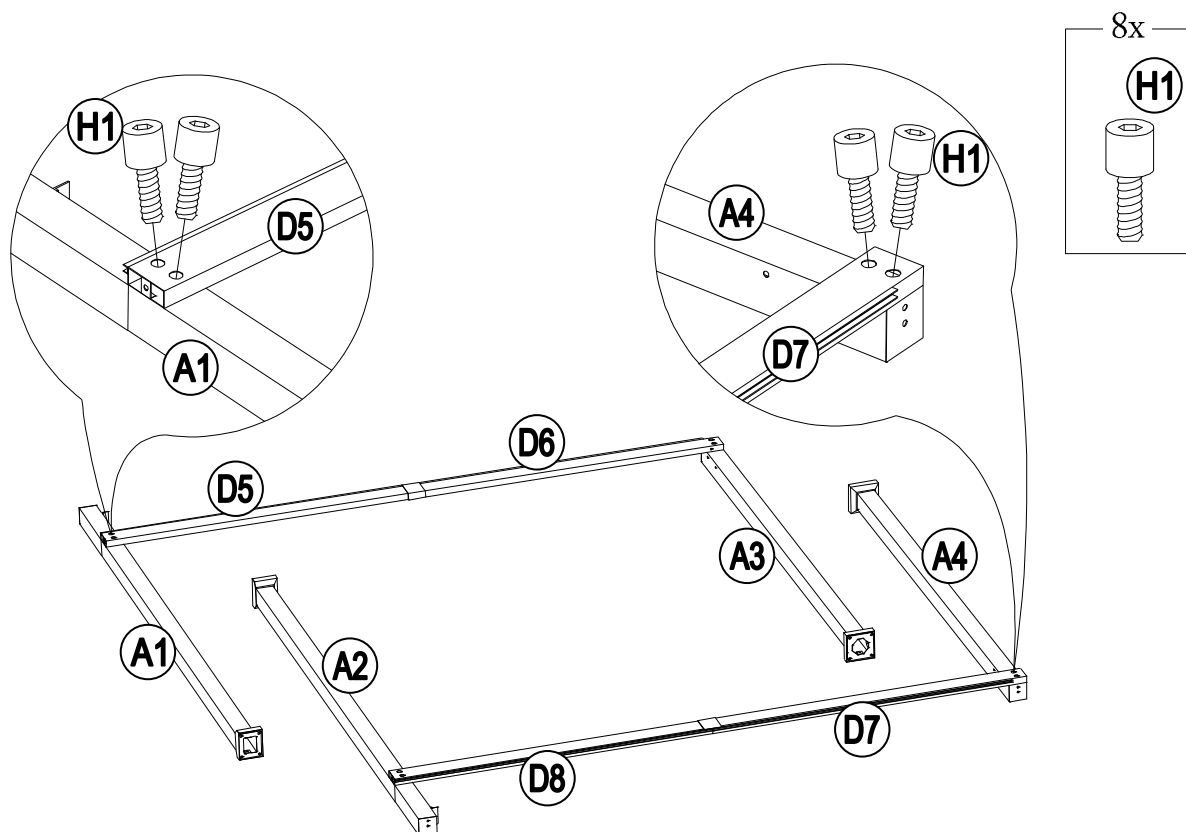

# 8

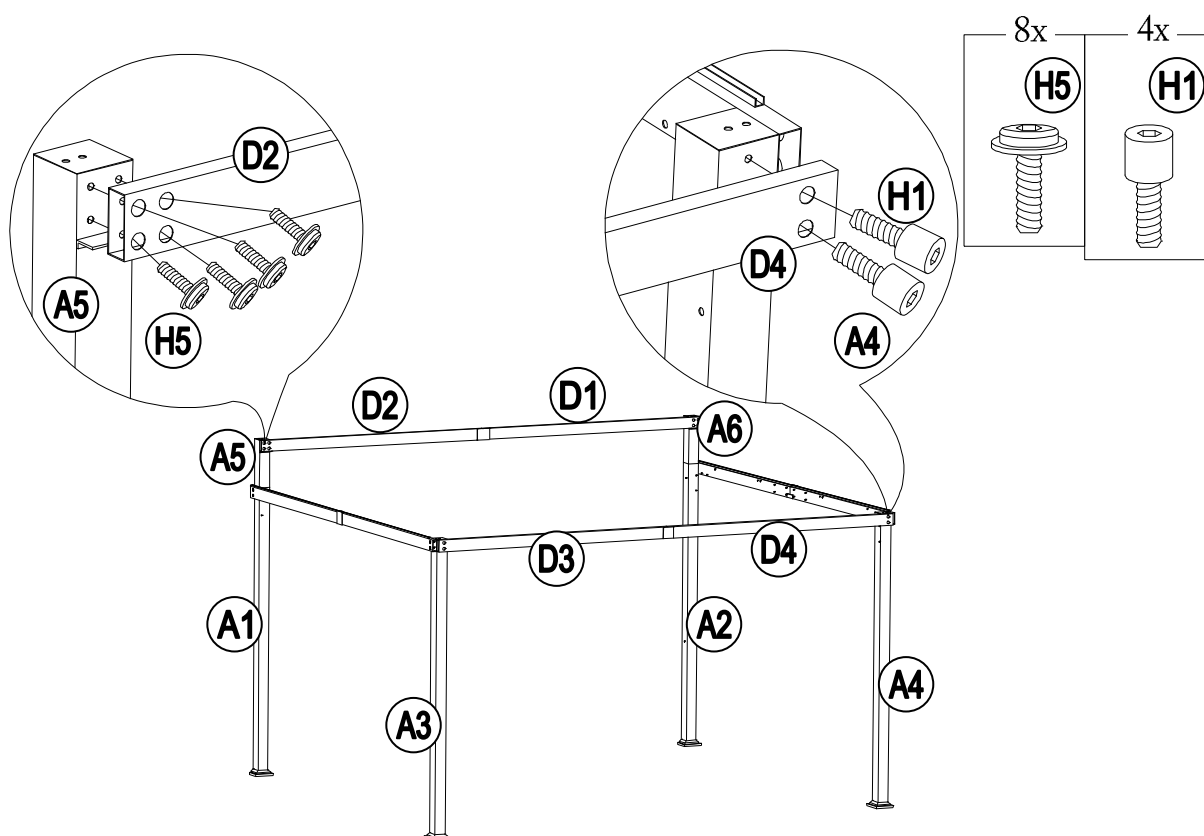

# 9

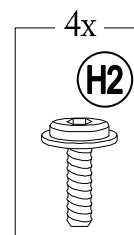
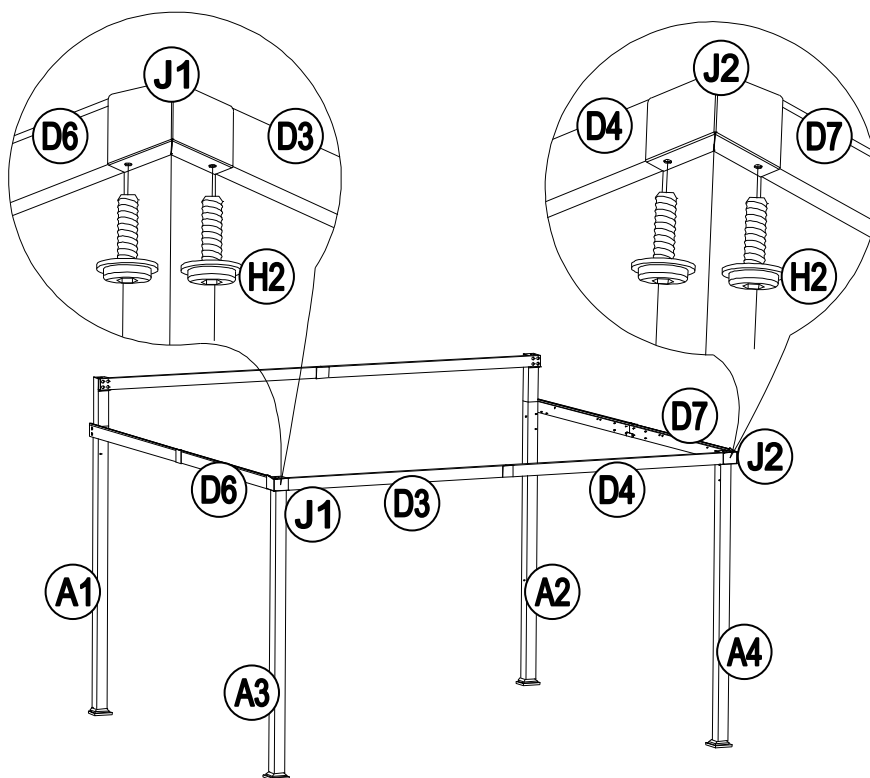
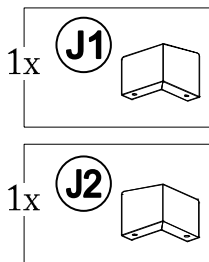

# 10

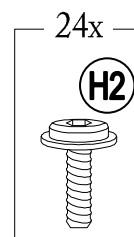
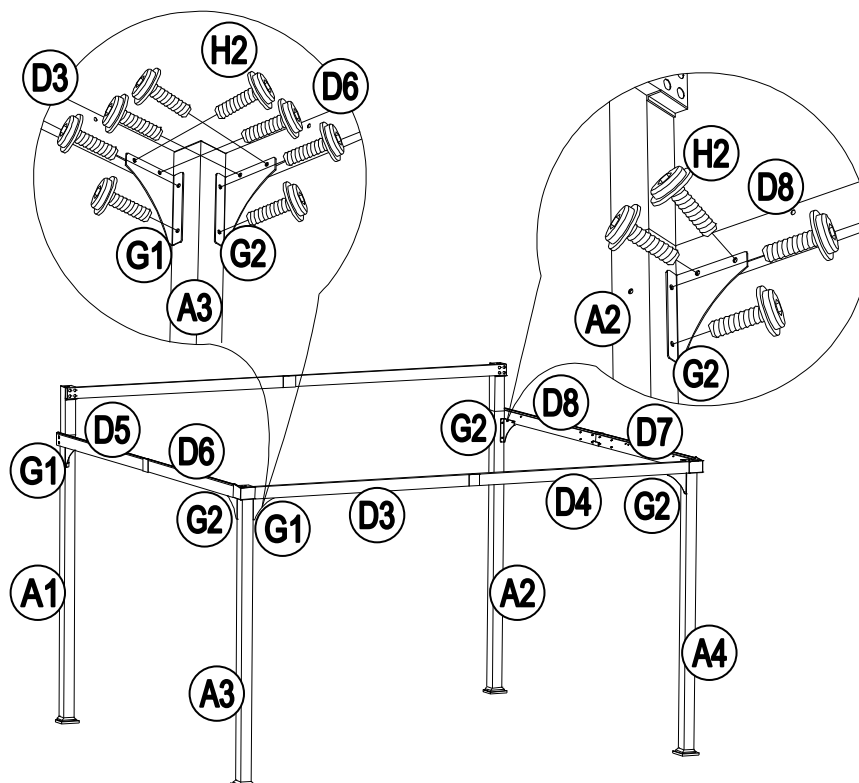
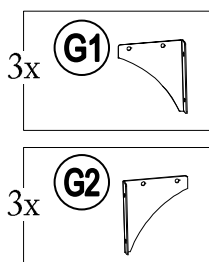

# 11

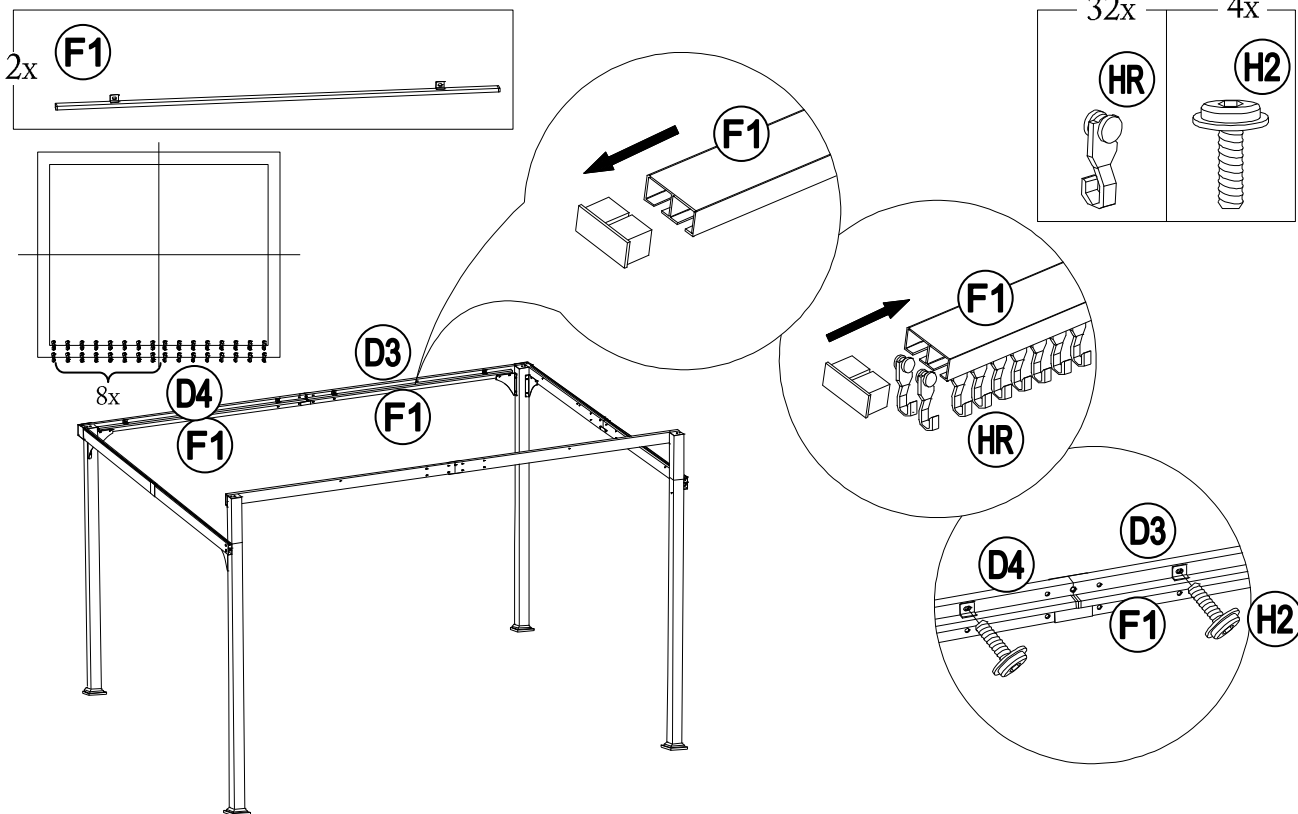

# 12

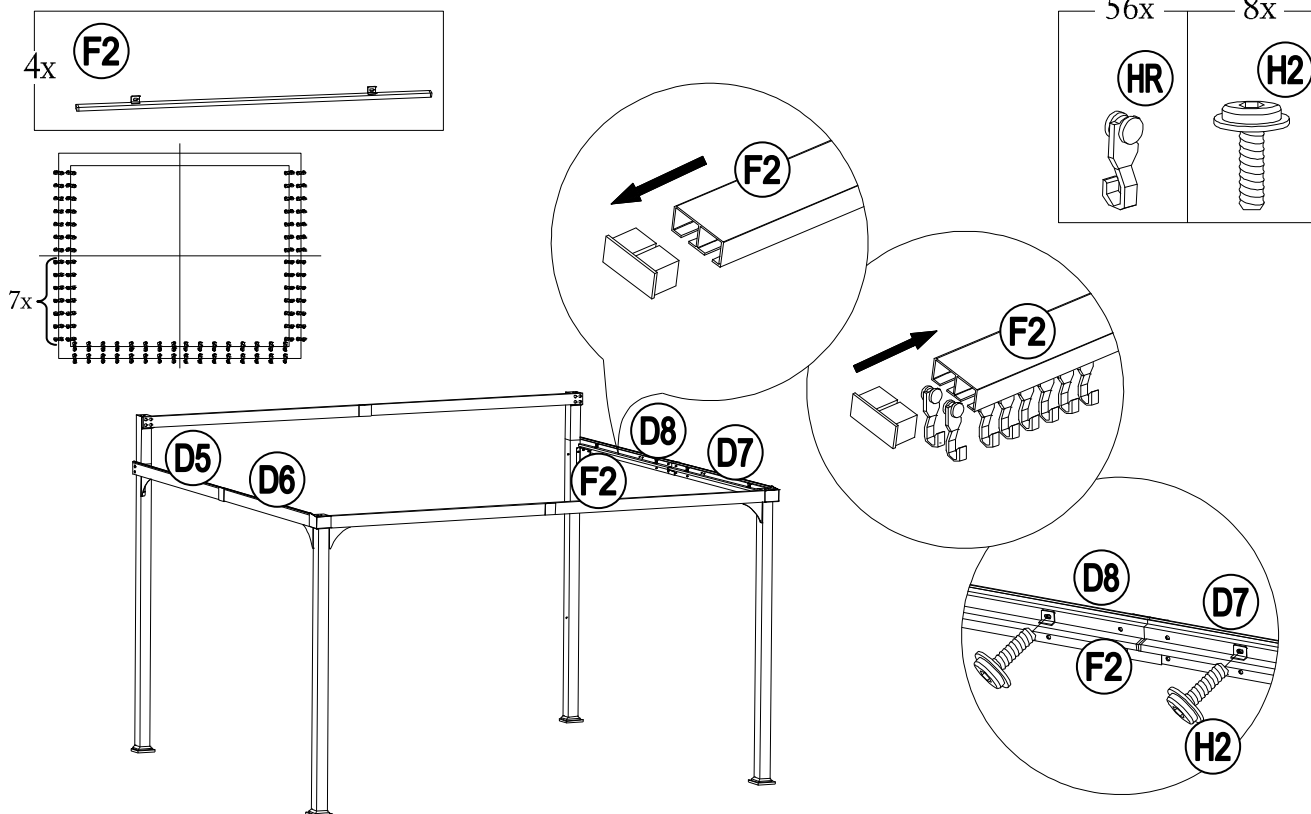

# 13

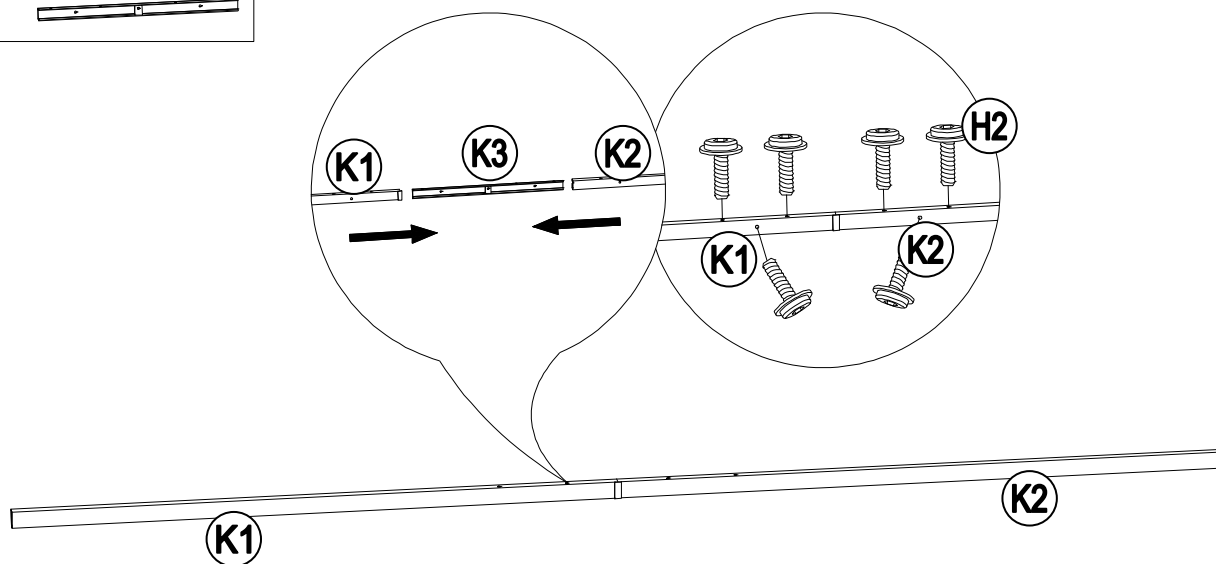
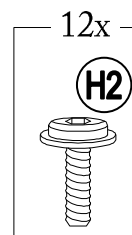
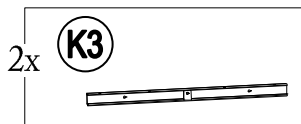
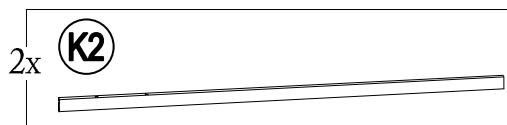
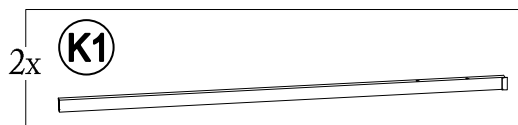

# 14

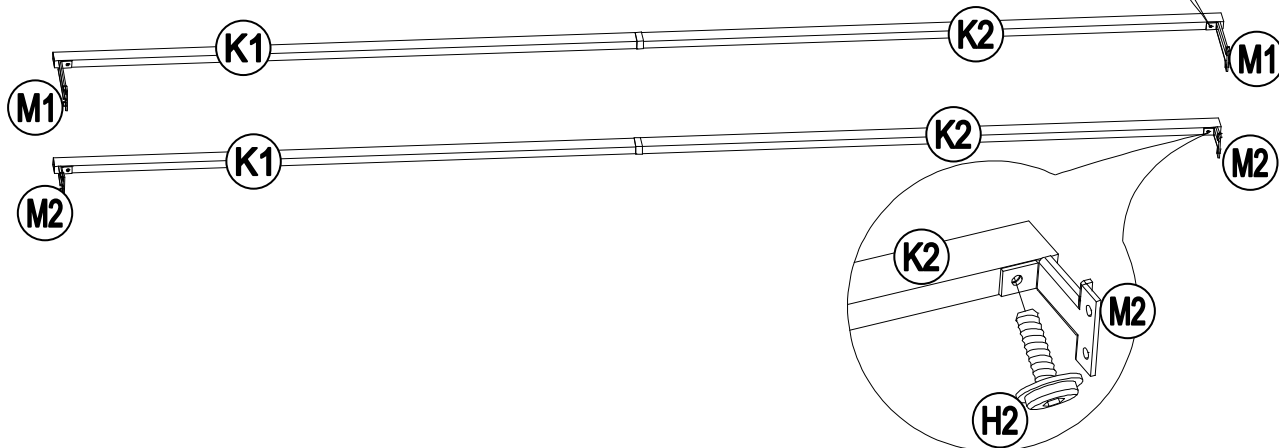
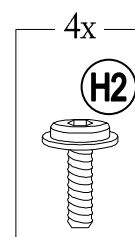
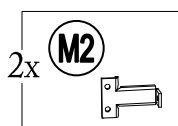
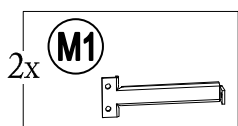



# 15

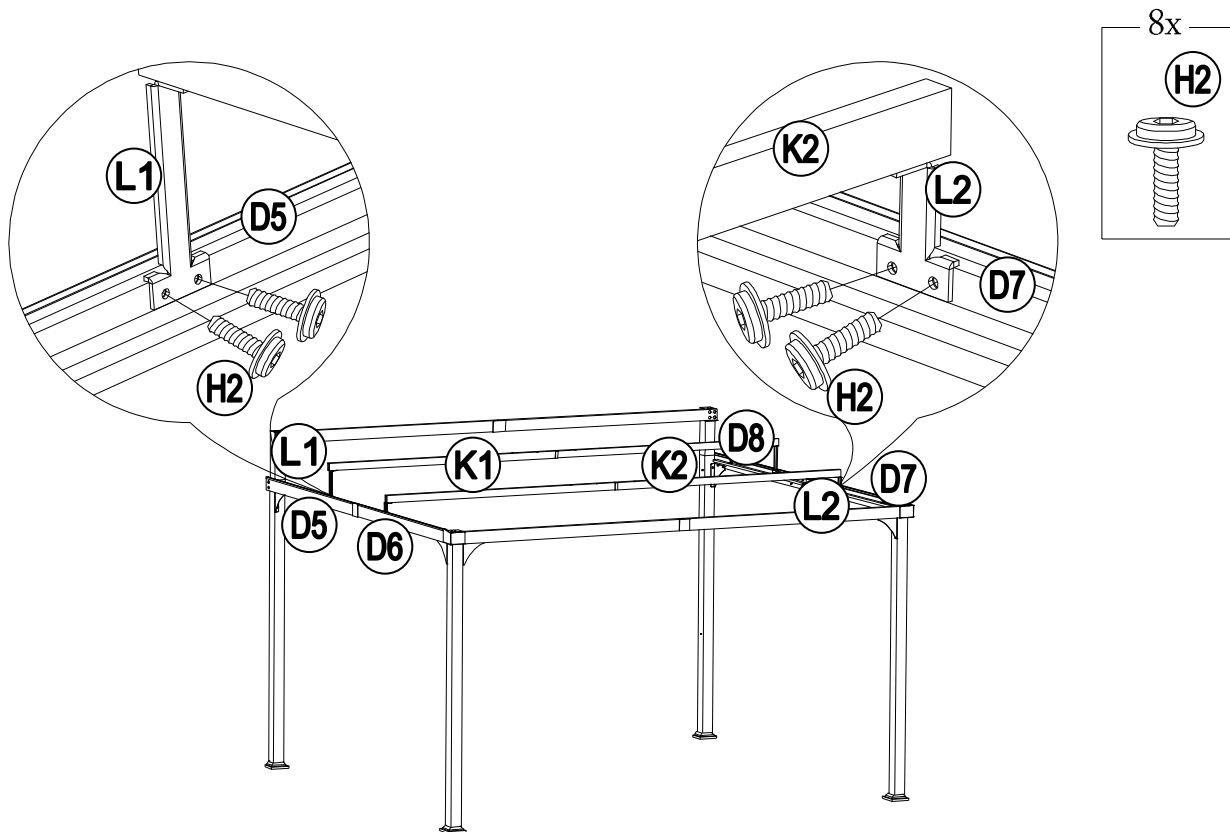

# 16

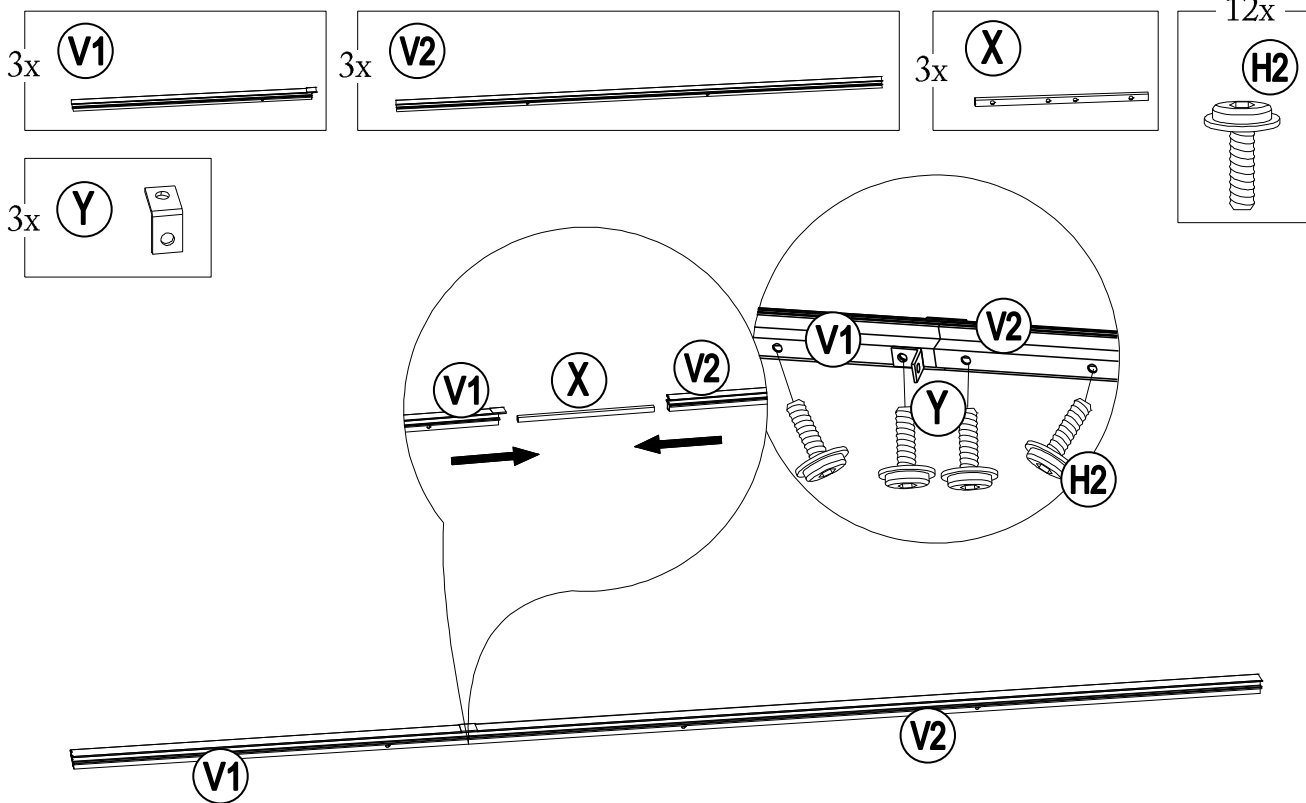

# 17

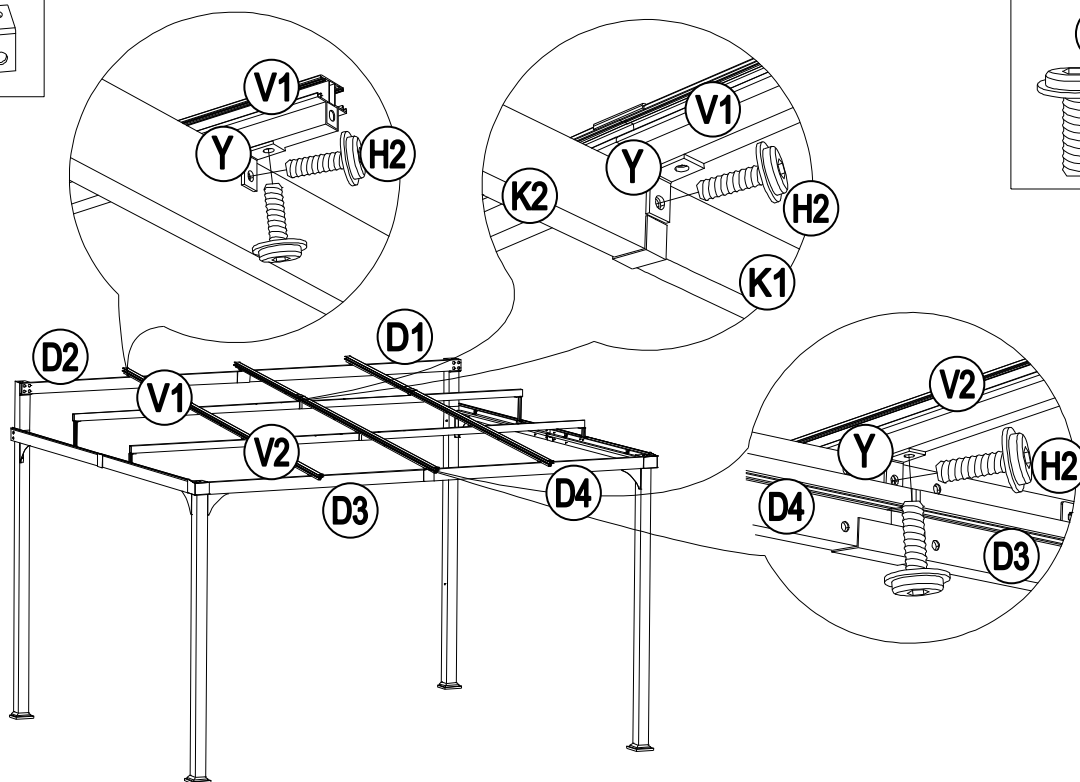
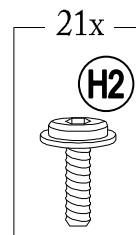
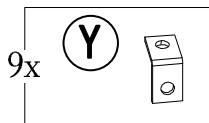

# 18

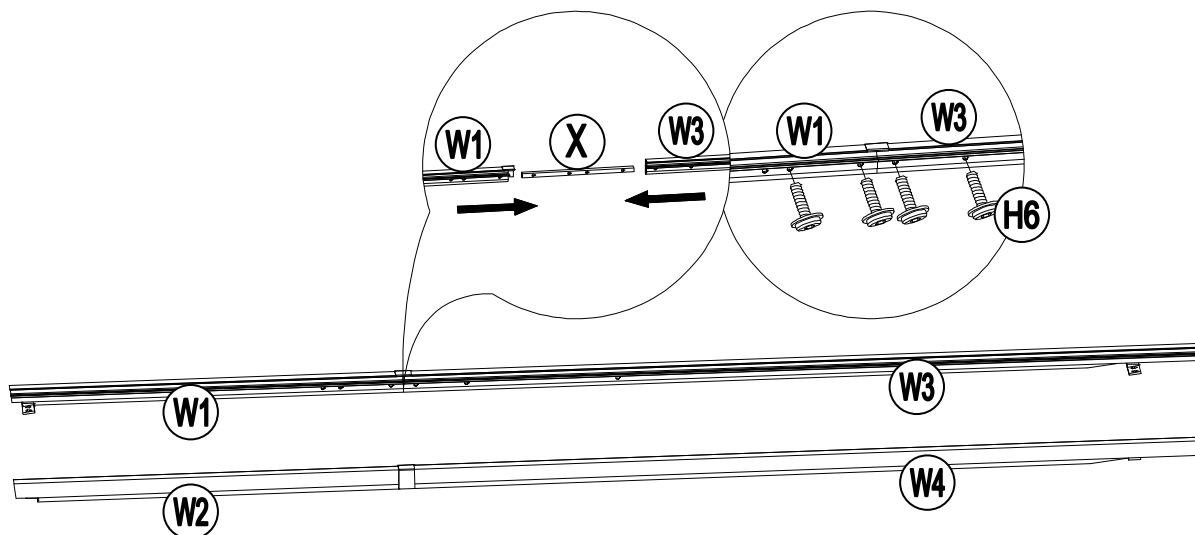
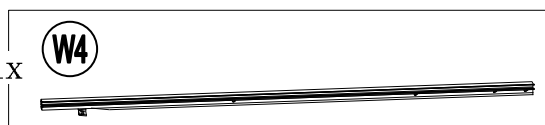
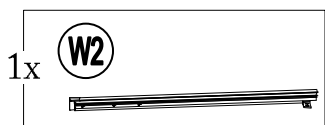
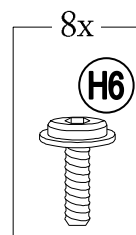
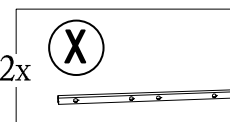

# 19

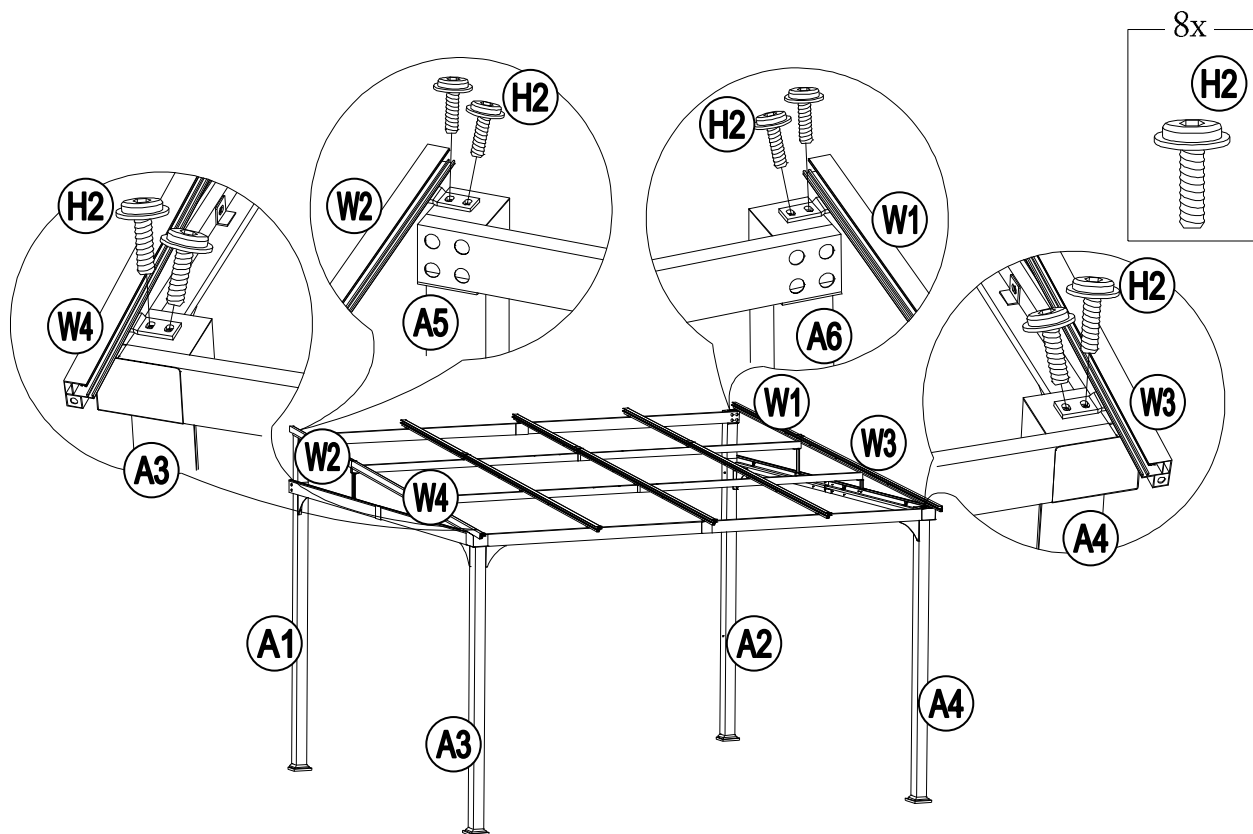

# 20

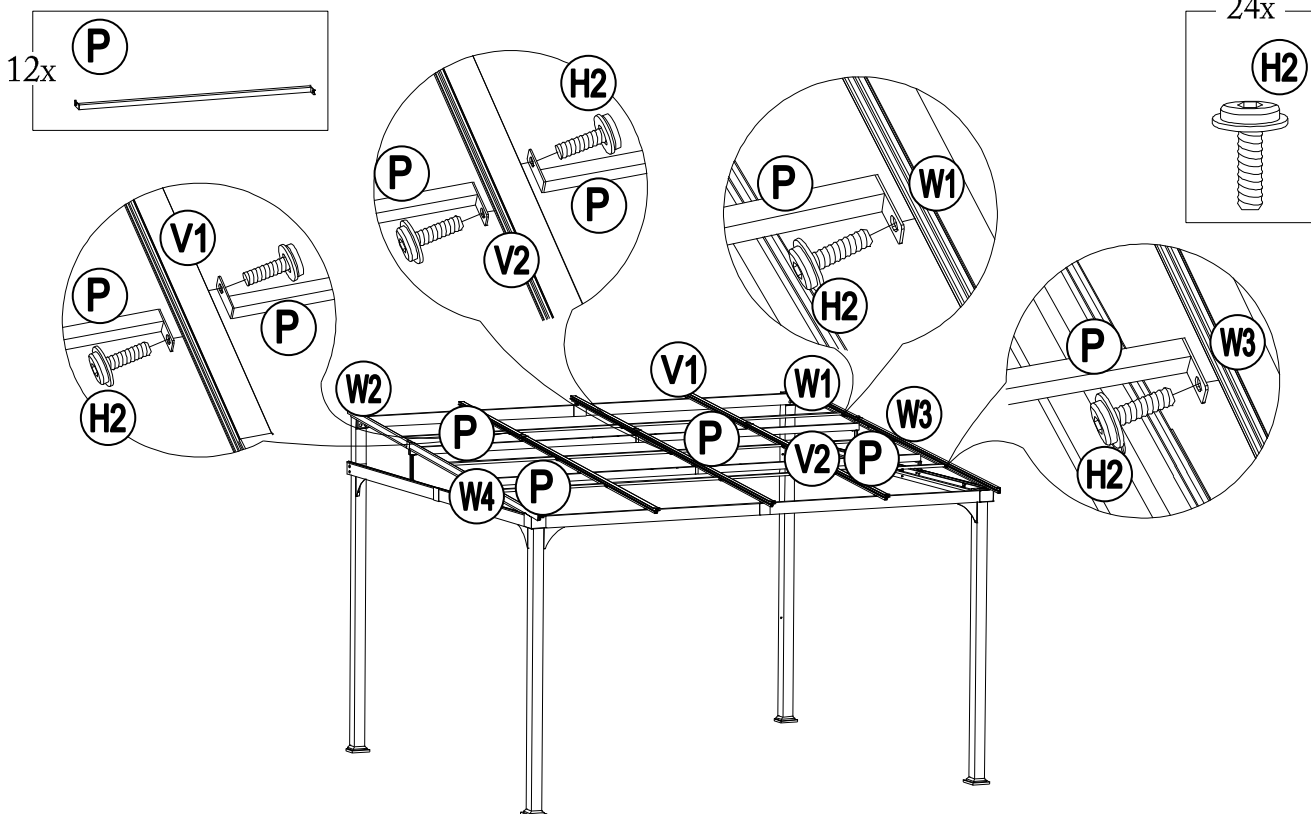

# 21

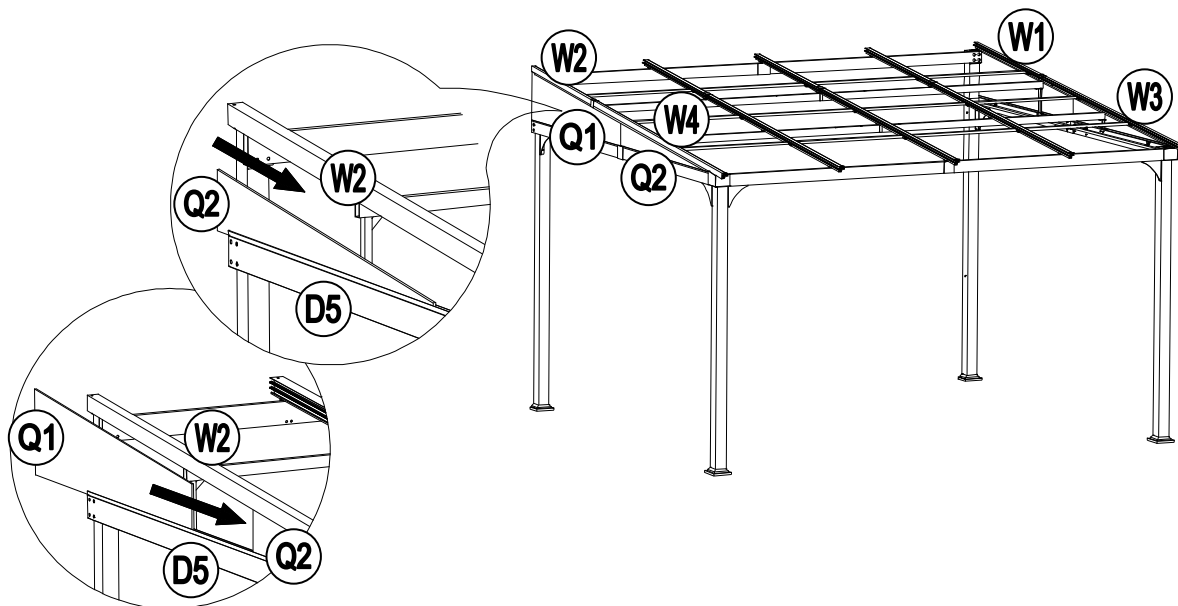
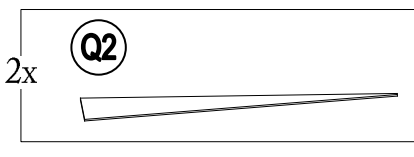
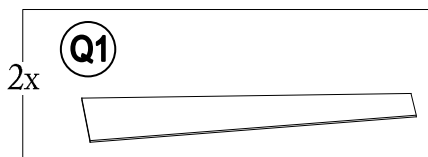

# 22

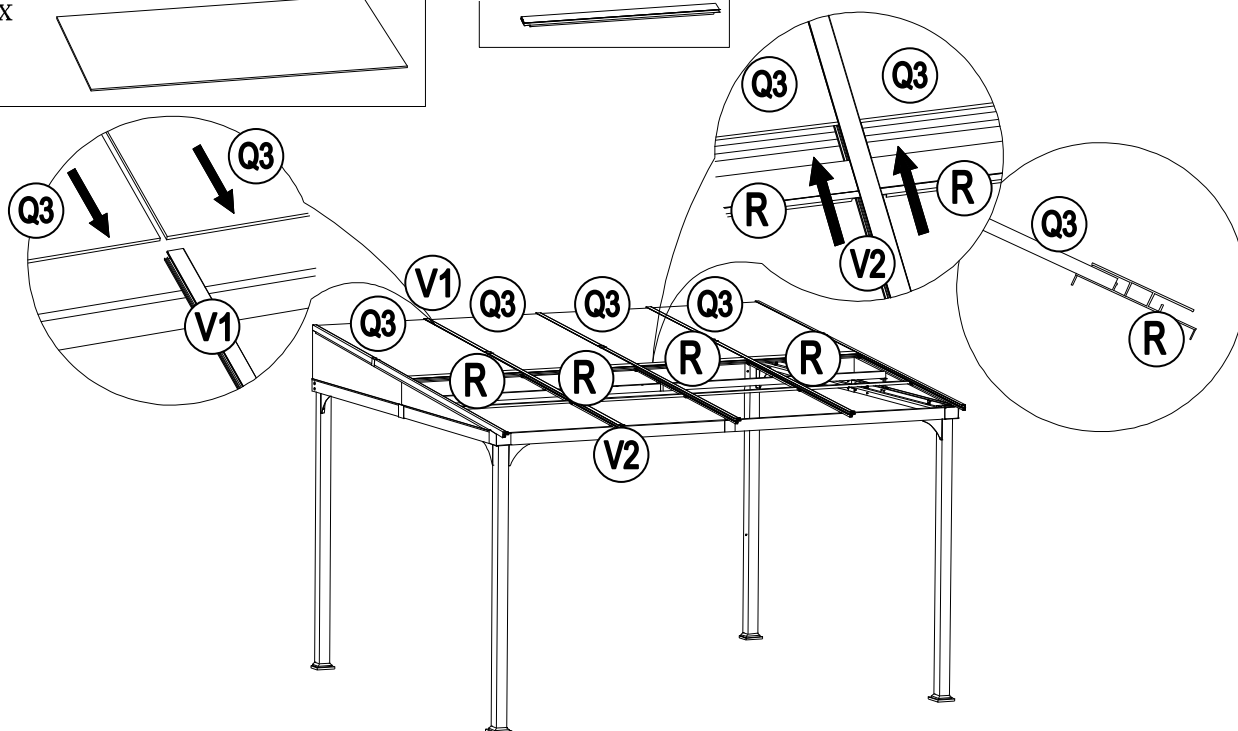
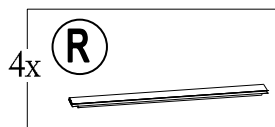
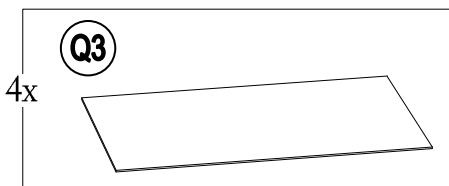

# 23

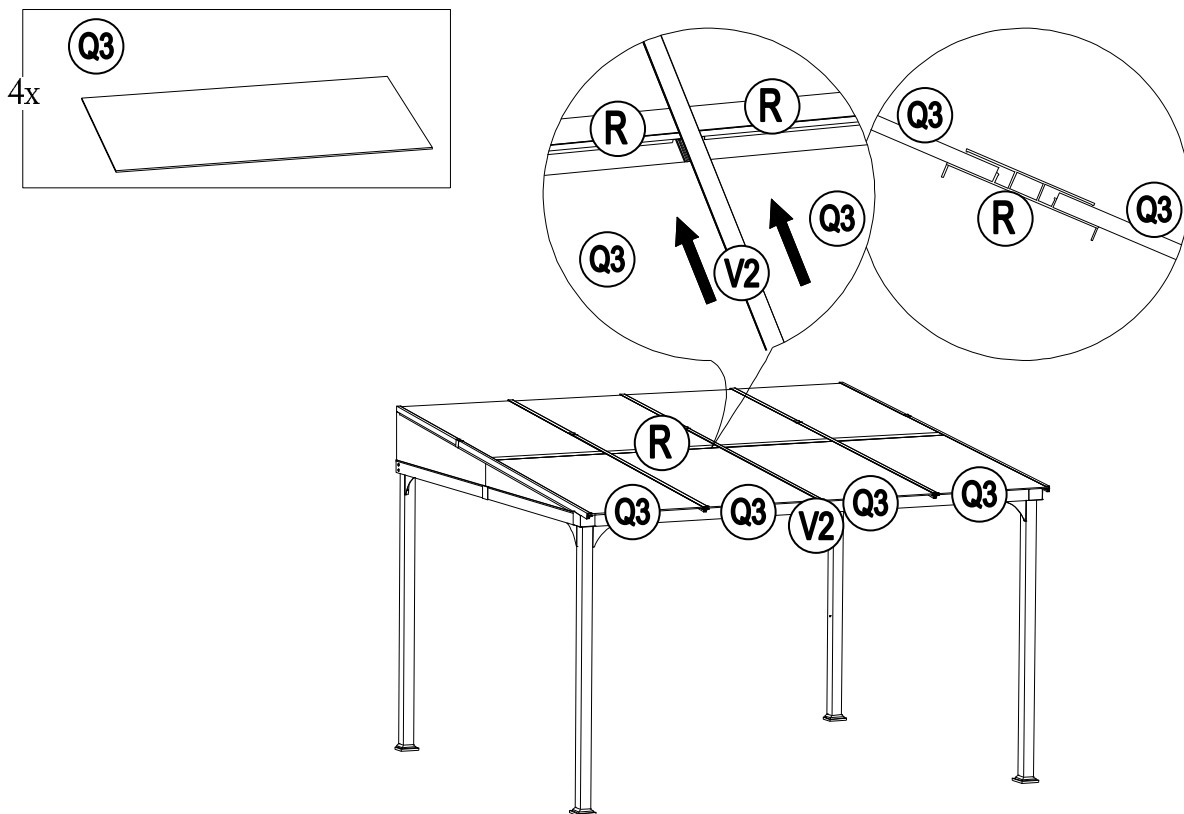

# 24

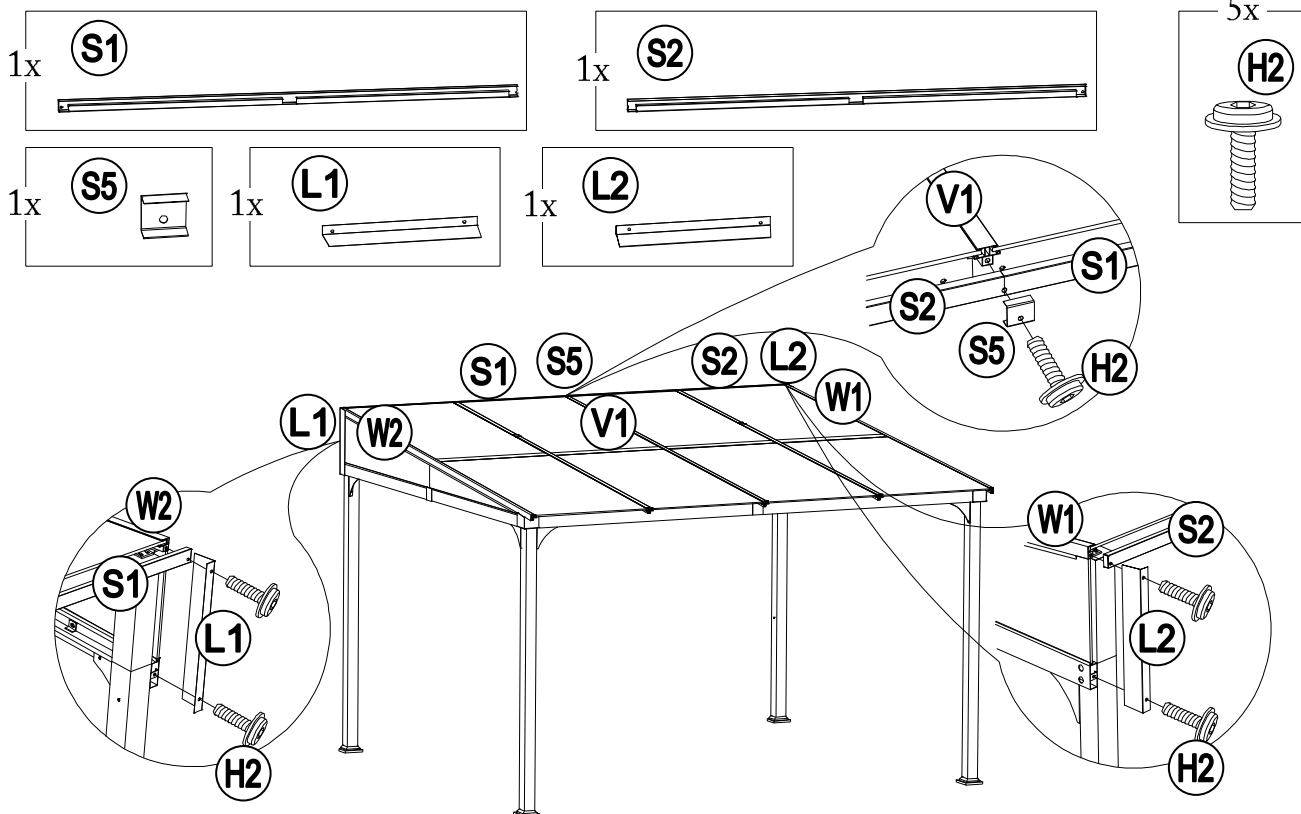

# 25

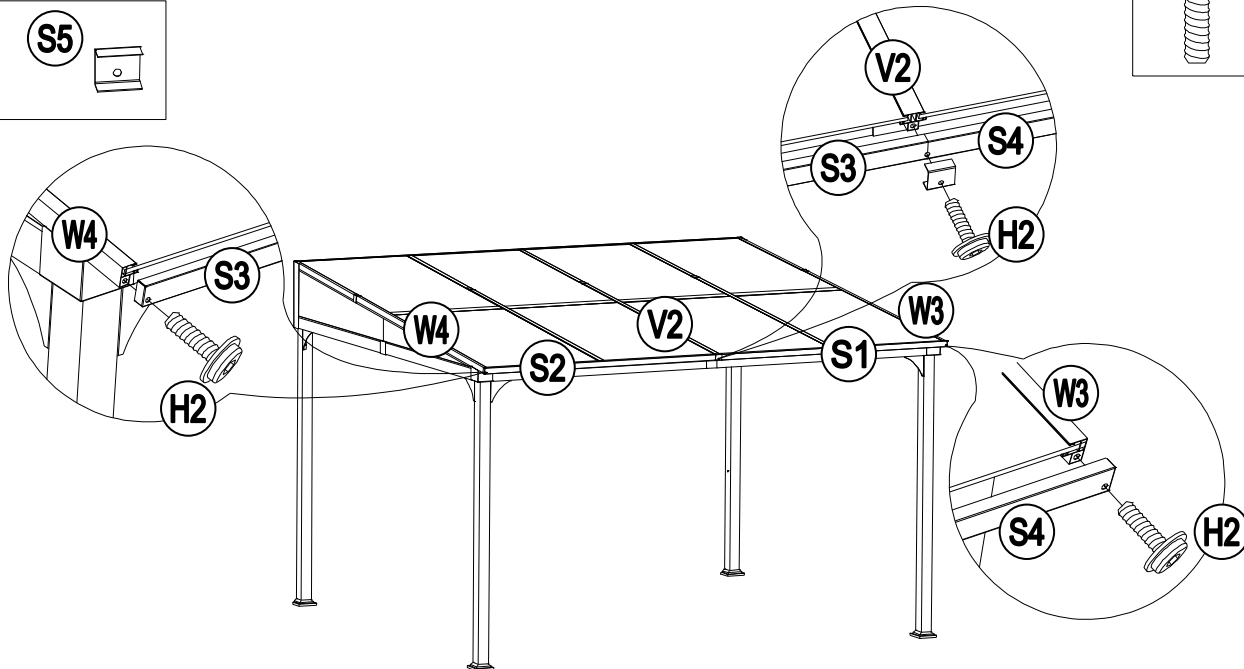
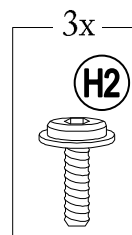
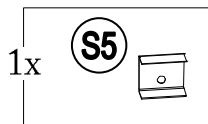
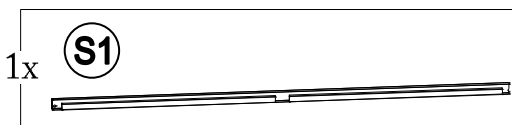
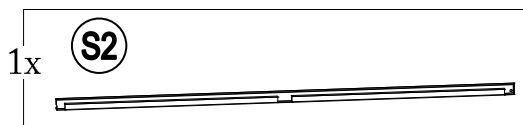

# 26

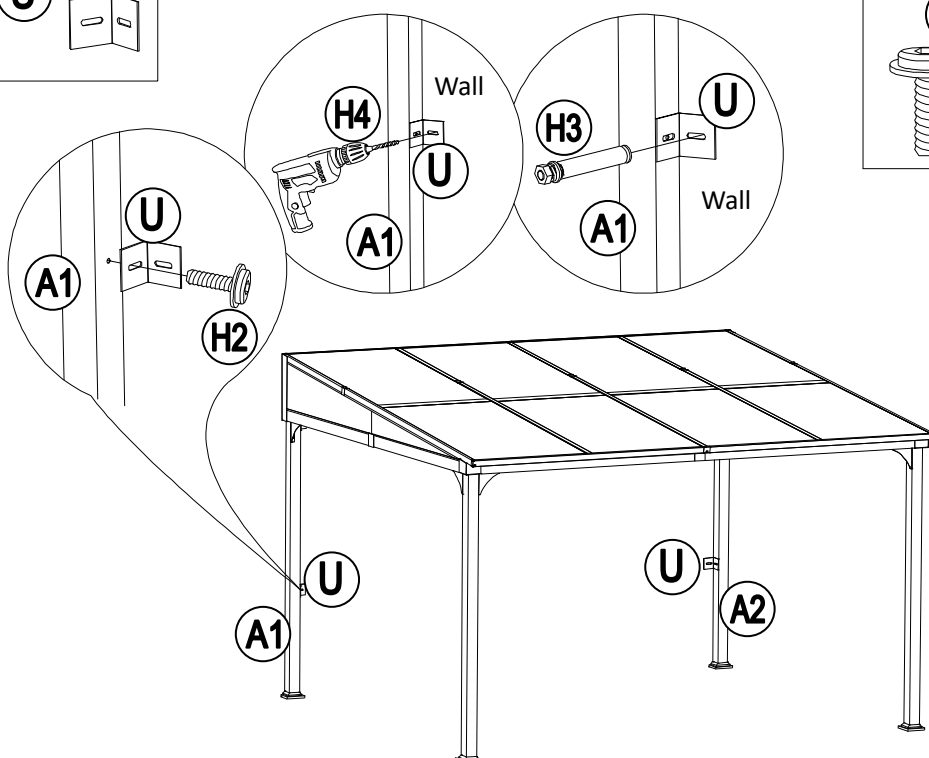
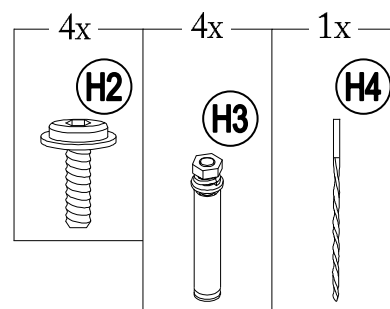
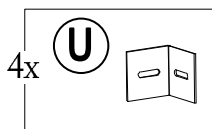

# 27

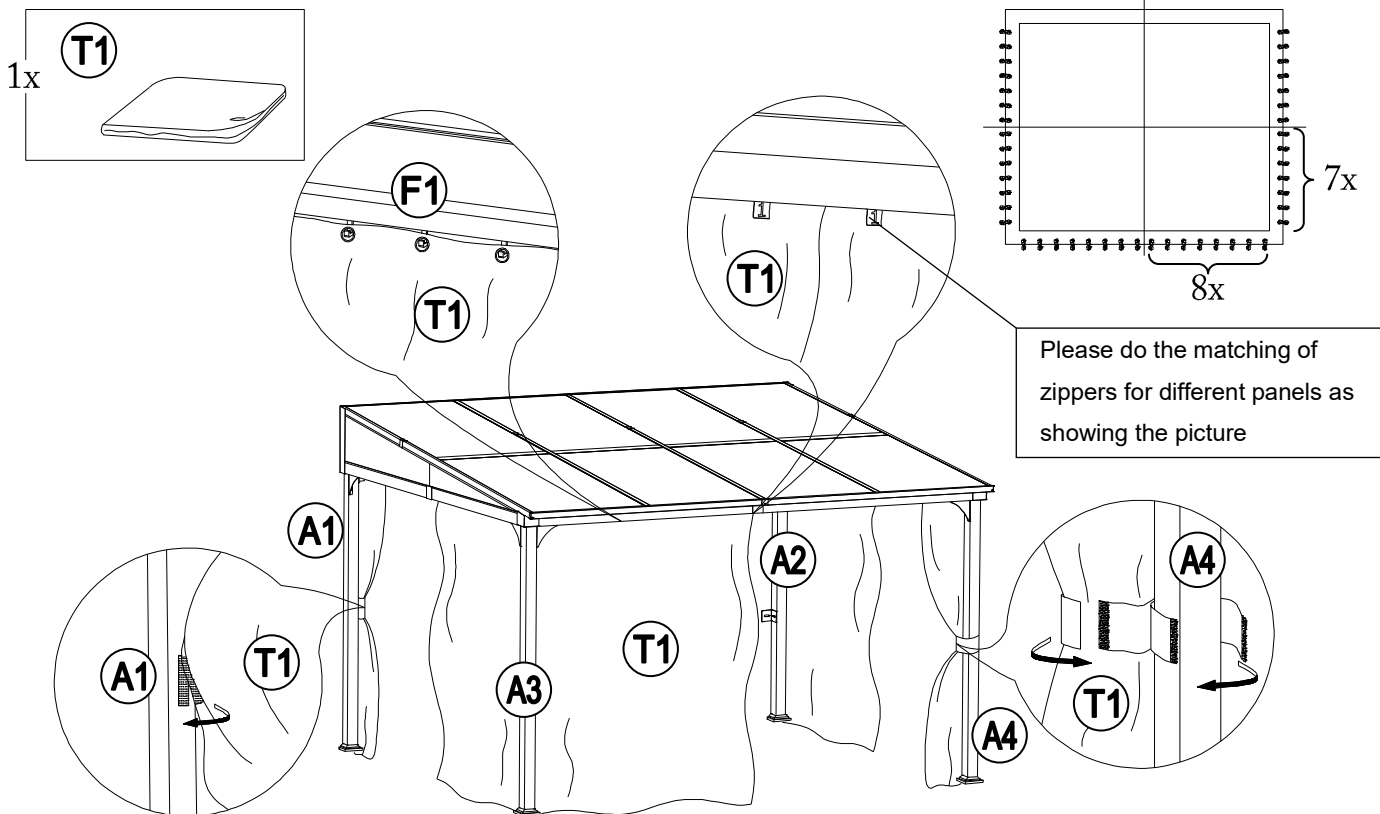

# 28

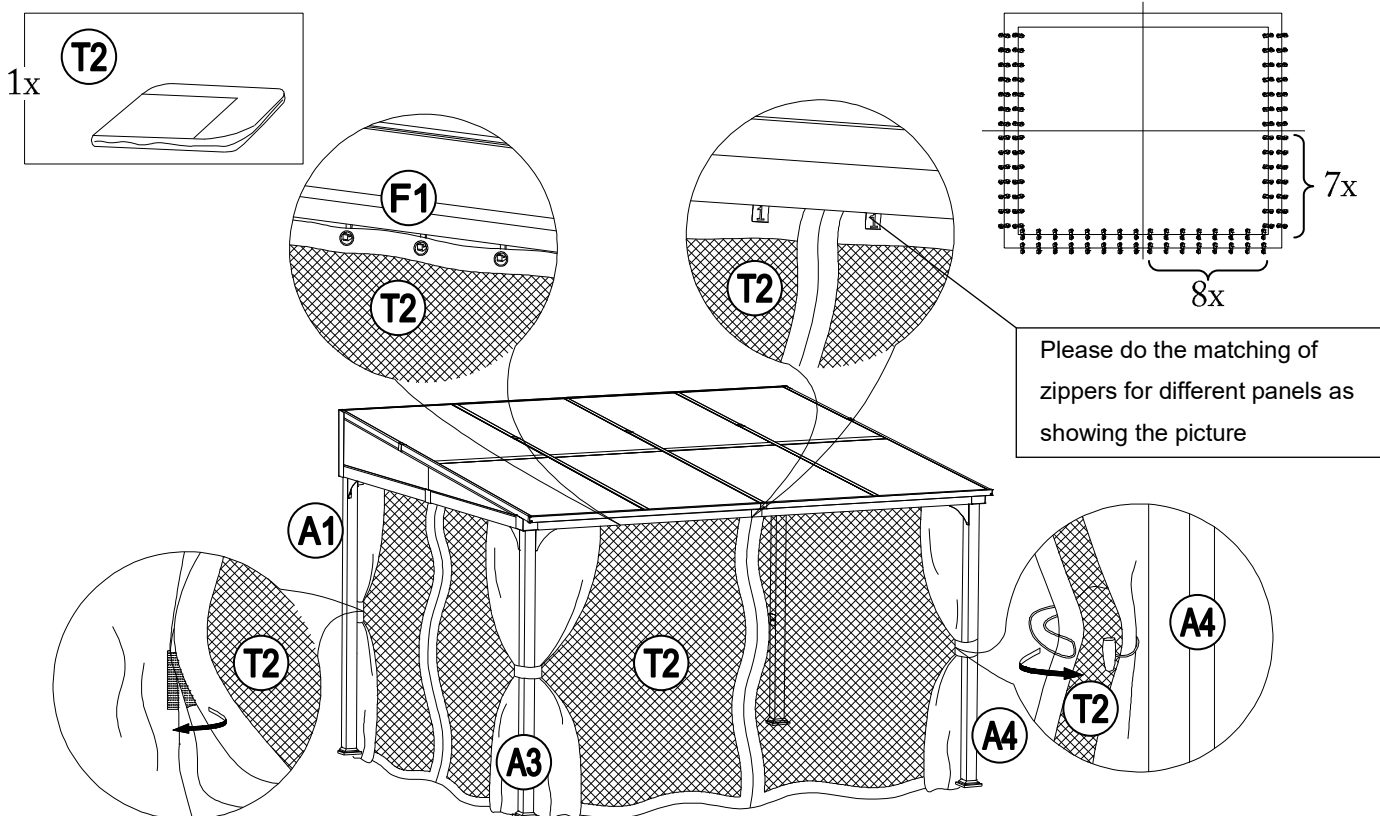

# 29

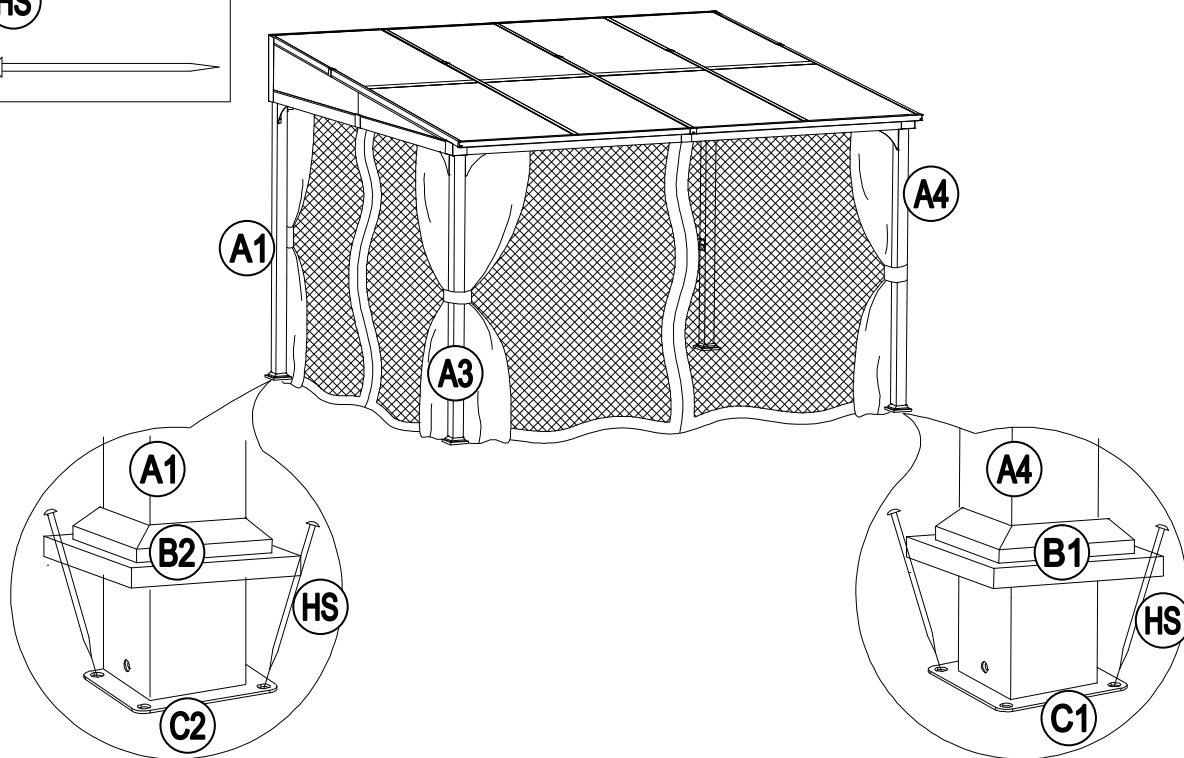
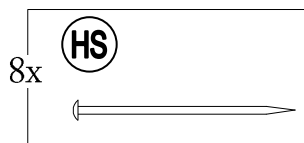



## Maintenance

- Steel components for this gazebo are treated with rust inhibiting paint . However, due to the nature of steel, surface oxidation (rusting) will occur if these protective coatings are scratched. This is not a defect and thus not covered by the warranty.
- To minimize this condition, it is recommended to use care when assembling and handling the product to prevent scratching the paint. Should any scratching or damage occur, it is recommended to cover the scratch immediately with rust inhibiting resistant paint (not included).
- Surface rust can also be easily removed with a very light application of regular cooking oil or WD-40. If surface oxidation (rusting) occurs and if no measure is taken to prevent this, the oxidation may start dripping onto deck or patio and caused damaging stains, which may be difficult to remove. This can be prevented if the above-mentioned measures are taken to keep the product from oxidizing.
- Do not use bleach, acid, or other abrasive cleaners on the roof or frame parts.
- Keep instruction manual for future reference.
- Keep the original packaging to store the gazebo.
- Periodically check and ensure that all bolts are well-tighten during use.

## Limited Manufacturer's Warranty

Sunjoy Group warrants to the original purchaser that this item is free from defects in workmanship and materials for a period of 1 year from the date of purchase, provided the item was factory-sealed at the time of purchase and is maintained with care and used only for personal, residential purposes. Should any manufacturing defect arise within this warranty period, Sunjoy Group will replace (at our option) any defective merchandise or parts upon proof of purchase; however, transportation and delivery costs, as well as payments to a third party for assembly or disassembly of the item, remain the responsibility of the purchaser. A purchaser of an "open box," previously-returned, or "clearance" item, as well as original purchasers outside of the warranty period, may obtain replacement parts from Sunjoy Group for products in current production, at nominal cost.

## Exclusions

Items used for commercial, contract, or other non-residential purposes, or items damaged due to acts of nature, vandalism, misuse, or improper assembly are not covered. Corrosion or rusting of hardware is not covered.

Proof of purchase (dated register receipt) is required for warranty claims. Warranty is to the original purchaser and is non-transferable. Any replacement of warranted items will be in the original style and color, or a similar style and color if the original is unavailable or has been discontinued. As some states do not allow exclusions or limitations on an implied warranty, the above exclusions and limitations may not apply. This warranty gives you specific rights, and you may also have other rights, which vary from state to state.

## Care and Maintenance

- Les composants en acier de ce belvédère sont traités avec une peinture antirouille. Toutefois, en raison de la nature de l'acier, une oxydation de la surface (rouille) se produira si ces revêtements protecteurs sont égratignés. La garantie ne couvre pas ce phénomène puisqu'il ne s'agit pas d'un défaut.
- Afin de minimiser cette situation, nous recommandons d'être prudent lors de l'assemblage et de la manipulation du produit afin d'éviter d'égratigner la peinture. En cas d'égratignure ou de dommage, nous recommandons d'effectuer immédiatement une retouche avec une peinture antirouille.
- La rouille de surface peut facilement être retirée à l'aide d'une petite quantité d'huile de cuisson ordinaire ou de WD-40. Si une oxydation (rouille) de la surface se produit et qu'aucune mesure n'est prise pour corriger la situation, la rouille pourrait couler sur la terrasse et causer des taches dommageables qui peuvent être difficiles à enlever. Cela peut être évité si les mesures mentionnées ci-dessus sont prises pour empêcher l'oxydation du produit.
- N'utilisez pas d'eau de Javel, d'acide ou d'autres nettoyeurs abrasifs sur le toit ou les pièces du cadre.
- Conservez le manuel d'instructions pour référence future.
- Conservez l'emballage d'origine pour ranger la tonnelle.
- Vérifiez périodiquement pour vous assurer que tous les écrous sont bien serrés pendant l'utilisation.

## Garantie limitée du fabricant

Sunjoy Group garantit à l'acheteur initial que ce produit ne présentera aucun défaut de fabrication et de matériaux pendant une période de un an à compter de la date de l'achat si le produit a été acheté dans son emballage scellé à l'usine, et s'il a été entretenu correctement et utilisé à des fins personnelles et résidentielles seulement. Si le produit présente un défaut de fabrication pendant cette période de garantie, Sunjoy Group remplacera (à sa discrétion) toute marchandise ou pièce défectueuse sur présentation d'une preuve d'achat. Toutefois, les frais de transport et de manutention, ainsi que les paiements versés à un tiers pour l'assemblage ou le démontage du produit, demeurent la responsabilité de l'acheteur. Les acheteurs de produits avec « boîte ouverte », précédemment retournés ou « en liquidation », ainsi que les acheteurs initiaux de produits dont la période de garantie est terminée, peuvent obtenir des pièces de rechange auprès de Sunjoy Group pour des produits actuellement en production, à peu de frais.

## Exclusions:

les articles utilisés à des fins commerciales, locatives ou non résidentielles et les articles endommagés par des phénomènes naturels, des actes de vandalisme, un usage inapproprié ou un assemblage inadéquat ne sont pas couverts. La corrosion et la rouille de la quincaillerie ne sont pas couvertes. Une preuve d'achat (une copie de votre reçu daté) doit être présentée avec toute réclamation au titre de la garantie. La garantie n'est accordée qu'à l'acheteur initial et est non transférable. Si l'article original n'est plus offert, il sera remplacé par un article d'une couleur et d'un style similaires. Certains États ou certaines provinces ne permettent pas l'exclusion ou la limitation d'une garantie implicite, de sorte que les limitations et exclusions mentionnées ci-dessus peuvent ne pas s'appliquer à vous. Cette garantie vous confère des droits précis. Il est possible que vous disposiez également d'autres droits, qui varient d'un État ou d'une province à l'autre.