

ASSEMBLY INSTRUCTION
Item/Article #: A102012600

SUMMERCOVE

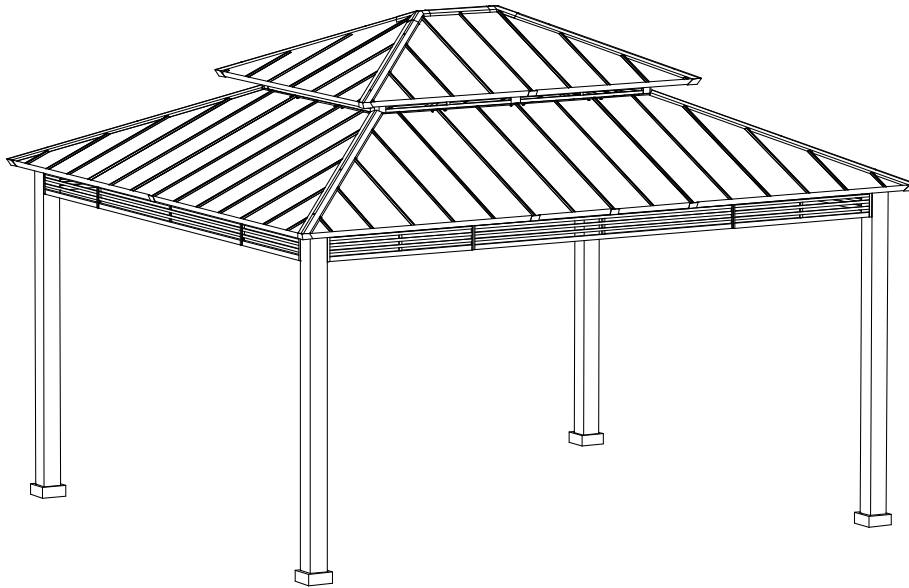

WE HAVE YOU IN MIND, LET US SERVE YOU!
Nous pensons en vous, laissez nous vous aider!

Questions? Issues? / Questions? Problèmes?

CONTACT US / Contactez-nous

24 hours / 7 days a week
24 heures / 7 jours par semaine

Warranty Parts
Liste des pièces sous
garantie

www.sunjoyonline.com



customer.care@sunjoygroup.com



A10201260022

Country of Origin: China
Pais d'origine: Chine

Production Number: XXXXXXXXXX
Numéro de fabrication: XXXXXXXXX

Important Safety Instructions



Warning! To reduce the risk of serious injury, read the following safety instructions before assembling and using the gazebo.

Please check with your local governing authority/local municipal codes regarding installation of structures before assembly.

Caution! Proper placement of your gazebo is essential.

Do not place the product underneath electrical lines.

Keep children away during assembly.

This product contains small parts which can be swallowed by children.

Keep fingers away from the places where they can be pinched or trapped.

Do not attempt to assemble the gazebo if any parts are missing.

- This product is intended for domestic outdoor use only.
- The product should be placed on flat, horizontal ground.
- Ensure enough clearance around the product. Before assembling the product, find level ground not less than 6' (1.8 m) away from any structures or obstructions, such as fences, garages, houses, overhanging branches, laundry lines, or electrical wires.
- This gazebo is not to be regarded as part of a building/house structure. The gazebo is to be anchored onto the ground for added safety. Do not assemble the gazebo onto soil/earth ground. It is best advisable to have the gazebo built onto a wooden deck or concrete ground for stability. If it is to be build onto a wooden deck/ground, do ensure that the wooden deck/ground has a strong foundation. It is advisable to use appropriate floor plugs (not provided) to anchor the gazebo onto the wooden/concrete ground.
- Some structures may require two or more people to install safely. Check for underground utilities before digging or driving stakes into the ground.
- During installation, follow all safety warnings provided with your tools, and use safety glasses.
- In case you set up more than one gazebo, keep a minimum distance of 10' (3 m) between the gazebos.
- Any assembly or maintenance of the product must be carried out by adults only.
- Arrange necessary manpower when assembling or moving the product.
- Some parts may contain sharp edges. Wear protective gloves if necessary.
- Keep children and pets away while setting up the gazebo.
- Check all nuts and bolts periodically to ensure bolts/nuts are tightened.
- Repairing and replacing parts should be done by a qualified technician.
- This gazebo is intended for decorative and sunshade purposes only, and it is not designed to withstand harsh weather, including high winds, rain, and snow.
- Do not light any fires inside or near the product !
- Stay calm if fire breaks out. Search for the nearest exit. Do not return to the gazebo before firemen allow you to do so.
- Do not hang heavy weights on the roof frame.
- Do not climb onto the roof of the gazebo. Falling off the gazebo can result in serious injury.
- Retain the original packaging to store the gazebo.

Country of Origin: China

Pais d'origine: Chine

Consignes de sécurité importantes



Avertissement! Veuillez lire les consignes de sécurité suivantes avant d'assembler et d'utiliser l'abri de jardin afin de réduire le risque de blessures graves.

Veuillez vous renseigner auprès des autorités locales concernant les codes municipaux à l'égard de l'installation des structures avant d'effectuer tout montage

ATTENTION! L'emplacement approprié de l'abri de jardin est essentiel.

Ne placez pas le produit en dessous de fils électriques.

Tenez les enfants à l'écart du produit pendant son assemblage.

Ce produit contient des petites pièces que les enfants peuvent avaler.

Tenez vos doigts éloignés des endroits où ils risquent d'être pincés ou blessés.

Ne tentez pas d'assembler l'abri de jardin s'il vous manque des pièces.

- Ce produit est uniquement destiné à un usage domestique et doit être utilisé à l'extérieur.
- L'abri de jardin doit être placé sur une surface plane et horizontale.
- Prévoyez un espace dégagé suffisant autour du produit. Avant de procéder à l'assemblage du produit, choisissez une surface au sol plane et éloignée d'au moins 6 pi (1,8 m) des structures ou obstructions environnantes, comme les clôtures, garages, maisons, branches surplombantes, cordes à linge ou fils électriques.
- Ce gazébo ne doit pas être considéré comme faisant partie d'une structure de bâtiment ou maison. Le gazébo doit être ancré à la terre pour plus de sécurité. Ne construisez pas le gazébo sur la terre ou le sol. Il est préférable de construire le gazébo sur une terrasse en bois ou ciment ou béton pour la stabilité. Si le gazébo doit être construit sur une terrasse en bois ou la terre, assurez-vous que la terrasse ou la terre a une base solide. Il est recommandé d'utiliser les boulons d'ancrage (pas compris) convenables pour ancrer le gazébo sur la surface en bois ou en ciment.
- Certaines structures peuvent nécessiter deux personnes ou plus pour l'installer en toute sécurité. Vérifiez les services publics souterrains avant de creuser ou d'enfoncer des piquets dans le sol.
- Lors de l'installation, suivez toutes les consignes de sécurité fournies avec vos outils et portez des lunettes de sécurité.
- Si vous installez plus d'un abri de jardin, gardez une distance minimale de 10 pi (3 m) entre les abris de jardin.
- L'assemblage et l'entretien de ce produit ne doivent être effectués que par des adultes.
- Au besoin, demandez à d'autres personnes de vous aider à assembler ou déplacer le produit.
- Certaines pièces peuvent contenir des bords tranchants. Portez des gants de protection si nécessaire.
- Tenez les enfants et les animaux à l'écart de l'abri de jardin pendant son assemblage.
- Assurez-vous périodiquement que tous les écrous et boulons pour s'assurer que les boulons / écrous sont serrés.
- La réparation et le remplacement des pièces doivent être effectués par un technicien qualifié.
- Cet abri de jardin est conçu uniquement pour des fins décoratives et de pare-soleil, et il n'est pas conçu pour résister aux intempéries, notamment les vents violents, la pluie et la neige.
- N'allumez pas un feu à l'intérieur ou près du produit!
- Si un incendie se déclare, restez calme. Cherchez la sortie la plus proche. Ne retournez pas à l'abri de jardin avant que:
 - les pompiers ne vous le permettent.
- Ne suspendez aucun poids lourd sur le cadre du toit. Ne montez pas sur le toit de l'abri de jardin. Tomber de l'abri de jardin peut entraîner des blessures graves.
- Conservez l'emballage original aux fins de remisage de l'abri de jardin.

Country of Origin: China

Pais d'origine: Chine

IMPORTANT:

- Please read and understand this manual before any assembly. Before beginning assembly of product, make sure all parts are present. Compare parts with packaging contents list.
- When assembling wooden parts, do not overtorque the bolts to avoid splitting the wood. See image illustration.
- Place all parts from the box in a cleared area and position them on the floor in front of you.
- Remove all packing materials and place them back into the box. Do not dispose of the packing materials until assembly is complete.
- Read each step carefully before beginning any assembly and make sure you understand each step. If you are missing a part, please email customer.care@sunjoygroup.com.
- Needed for assembly: (The following tools are not included)

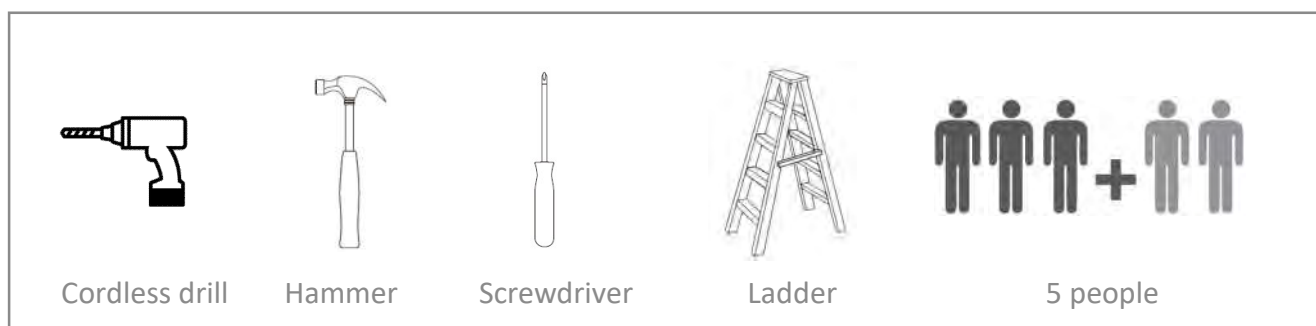

This identifies information that requires special attention. Improper assembly could lead to an unsafe or dangerous condition.

**Use Level**

Check that set or assembly is properly level before proceeding.

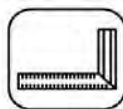
**Square Assembly**

Check that assembly is square before tightening bolts.

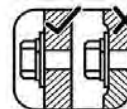
**Tighten Bolts**

Do not overtorque mounting bolts. Over-tightening may cause the wood to crack creating splinters and other structural damage.

**Measure Distance**

IMPORTANT:

- Veuillez lire et bien comprendre ce guide avant de procéder à l'assemblage. Avant de procéder à l'assemblage du produit, assurez-vous que toutes les pièces sont présentes.
- Lors de l'assemblage de pièces en bois, ne serrez pas trop les boulons afin d'éviter de fendre le bois.
- Consultez l'illustration dans les schémas. Mettez toutes les pièces de la boîte dans une zone dégagée et positionnez-les sur le sol devant vous.
- Retirez tous les matériels d'emballage et remettez-les dans la boîte. Ne les jetez pas avant d'avoir terminé l'assemblage.
- Nécessaire pour l'assemblage : les outils suivants ne sont pas inclus.

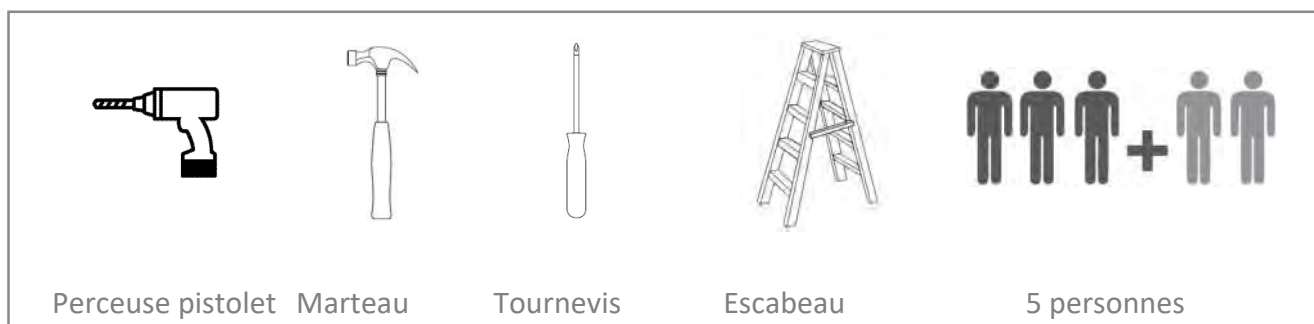

Cette icône identifie de l'information
Utilisez un niveau Vérifiez avec un
équerre Serrez les boulons Mesurer
la distance

**Utilisez un niveau**

Vérifiez que l'assemblage est d'aplomb
avant de procéder à la prochaine étape.

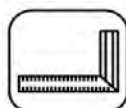
**Vérifiez avec un équerre**

Vérifiez que l'assemblage est carré avant
de serrez les boulons.

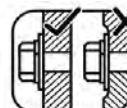
**Serrez les boulons**







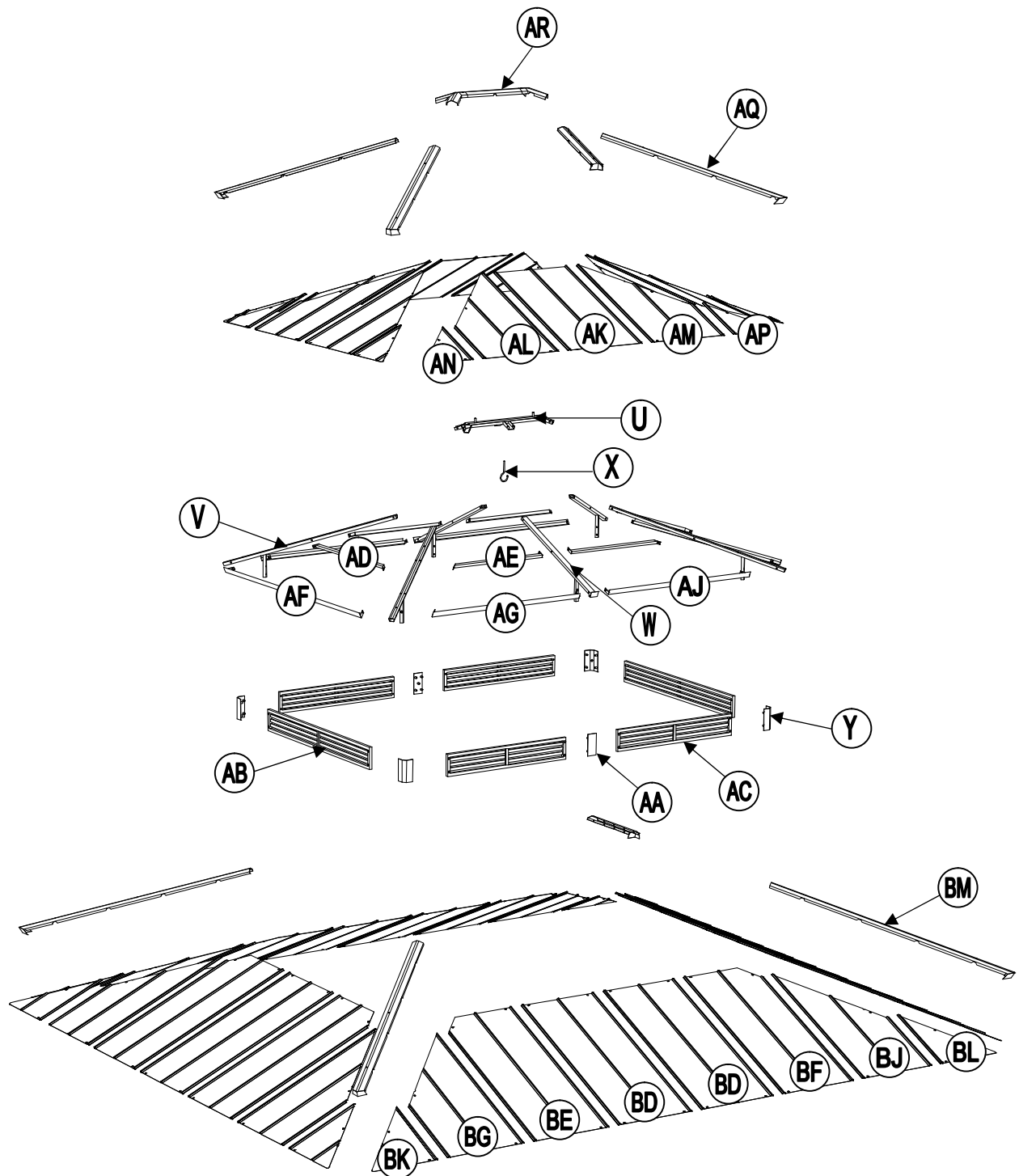

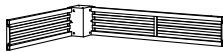

Ne serrez pas trop les boulons de fixation. Un
serrage excessif peut provoquer des fissures
dans le bois, créant des éclats de bois et d'autres
dommages structurels

**Mesurer la distance**

EXPLODED DRAWING/DESSIN ÉCLATÉ



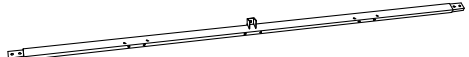







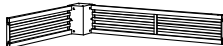

Country of Origin: China
 Pais d'origine: Chine











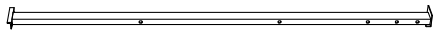

Parts List				
Label	Part Number	Description	Qty	Part Image
A	P00020065801	Post	4	
B	P00610023101	Base Cover	4	
C	P00010045701	Post Base	4	
D	P00630012101	Screen 1	2	
E	P00630012201	Screen 2	2	
F	P00630012301	Middle Screen	4	
G	P00050168201	Middle Beam Connector	8	
J	P00050168301	Rafter Connector	4	
K	P00050156803	Big Roof Short Connector Tube	2	
L	P00050156903	Big Roof Long Connector Tube	2	
M	P00050157506	Big Top Corner Connector	4	
N	P00060197105	Rafter (Big Roof)	4	

Country of Origin: China











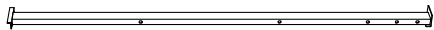

Pais d'origine: Chine











Liste de Pièces				
Étiquette	Numéro de la Pièce	Description	Quantité	Numéro de la Pièce Diagramme
A	P00020065801	Poteau	4	
B	P00610023101	Capuchon de pied	4	
C	P00010045701	Base du Poteau	4	
D	P00630012101	Façade 1	2	
E	P00630012201	Façade 2	2	
F	P00630012301	Façade Centrale	4	
G	P00050168201	Connexion de la Poutre Centrale	8	
J	P00050168301	Connexion du Chevron	4	
K	P00050156803	Tuyau de Connexion Court du Grand Toit	2	
L	P00050156903	Tuyau de Connexion Long du Grand Toit	2	
M	P00050157506	Connexion du Coin du Grand Toit	4	
N	P00060197105	Chevron (Grand Toit)	4	





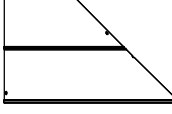
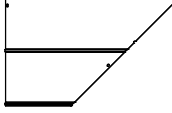





Country of Origin: China
Pais d'origine: Chine





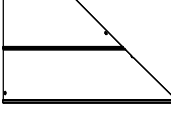
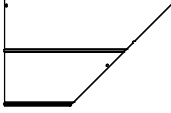





P	P00060198305	Middle Beam	8	
Q	P00570034704	Short Mosquito Netting Rod 1	2	
R	P00570034804	Short Mosquito Netting Rod 2	2	
S	P00570034904	Left Mosquito Netting Rod (Oversize Long Side)	2	
T	P00570035004	Right Mosquito Netting Rod (Oversize Long Side)	2	
U	P00050156403	Small Roof Connector	1	
V	P00060105803	Small Roof Rafter Beam	4	
W	P00060195903	Small Roof Middle Beam	2	
X	P005800001	Hook	1	
Y	P00050168401	Corner Fence Connector	4	
AA	P00050168501	Middle Fence Connector	2	
AB	P00560047301	Fence (Short Side)	2	
AC	P00560047201	Fence (Long Side)	4	

Country of Origin: China
Pais d'origine: Chine

P	P00060198305	Poutre Centrale	8	
Q	P00570034704	Tringle Courte du Filet Moustiquaire 1	2	
R	P00570034804	Tringle Courte du Filet Moustiquaire 2	2	
S	P00570034904	Tringle Gauche du Filet Moustiquaire (Côté Long XXXL)	2	
T	P00570035004	Tringle Droite du Filet Moustiquaire (Côté Long XXXL)	2	
U	P00050156403	Connexion du Petit Toit	1	
V	P00060105803	Poutre du Plafond du Petit Toit	4	
W	P00060195903	Poutre Centrale du Petit Toit	2	
X	P005800001	Crochet	1	
Y	P00050168401	Connexion de la Barrière du Coin	4	
AA	P00050168501	Connexion de la Barrière Centrale	2	
AB	P00560047301	Barrière (Côté Court)	2	
AC	P00560047201	Barrière (Côté Long)	4	





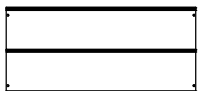
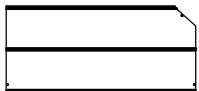
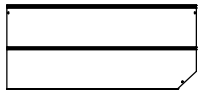





AD	P00060196103	Small Roof Top Beam(Short Side)	2	
AE	P00060196403	Small Roof Top Beam(Long Side)	4	
AF	P00060202303	Small Roof Panel Flashing(Short Side)	2	
AG	P00060202803	Small Roof Left Panel Flashing(Long Side)	2	
AJ	P00060202903	Small Roof Right Panel Flashing(Long Side)	2	
AK	P00070093703	Small Roof Panel (Middle)	2	
AL	P00070093603	Small Roof Panel (Left Middle)	4	
AM	P00070093803	Small Roof Panel (Right Middle)	4	
AN	P00070093503	Small Roof Small Panel (Left)	4	
AP	P00070093903	Small Roof Small Panel (Right)	4	
AQ	P00080018903	Small Roof Inclined Beam Cap	4	
AR	P00090004004	Small Top Cover	1	

AD	P00060196103	Poutre Supérieure du Petit Toit (Côté Court)	2	
AE	P00060196403	Poutre Supérieure du Petit Toit (Côté Long)	4	
AF	P00060202303	Solin du Panneau du Petit Toit (Côté Court)	2	
AG	P00060202803	Solin du Panneau Gauche du Petit Toit (Côté Long)	2	
AJ	P00060202903	Solin du Panneau Droit du Petit Toit (Côté Long)	2	
AK	P00070093703	Panneau du Petit Toit (Centre)	2	
AL	P00070093603	Panneau du Petit Toit (Centre Gauche)	4	
AM	P00070093803	Panneau du Petit Toit (Centre Droit)	4	
AN	P00070093503	Panneau du Petit Toit (Gauche)	4	
AP	P00070093903	Panneau du Petit Toit (Droit)	4	
AQ	P00080018903	Opercule de la Poutre Inclignée du Petit Toit	4	
AR	P00090004004	Toiture du Petit Toit	1	

AS	P00060199004	Big Roof Upper Top Beam (Short Side)	4	
AT	P00060198905	Big Roof Upper Top Beam (Long Side)	4	
AU	P00060200904	Big Roof Middle Top Beam(Oversize Long Side)	8	
AV	P00060200004	Big Roof Upper Top Beam (Short Side)	4	
AW	P00060199905	Big Roof Upper Top Beam (Long Side)	4	
AX	P00060201304	Big Roof Left Panel Flashing (Short Side)	2	
AY	P00060201705	Big Roof Right Panel Flashing (Short Side)	2	
BA	P00060201205	Big Roof Left Panel Flashing (Long Side)	2	
BB	P00060201604	Big Roof Right Panel Flashing (Long Side)	2	
BC	P00060201804	Big Roof Middle Panel Flashing (Oversize Side)	4	
BD	P00070103504	Big Roof Middle Panel	6	
BE	P00070102105	Big Roof Big Panel (Left)	4	
BF	P00070102605	Big Roof Big Panel (Right)	4	



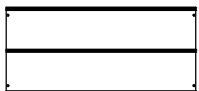
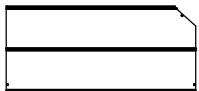
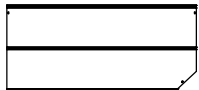

Country of Origin: China



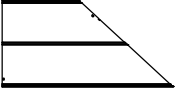
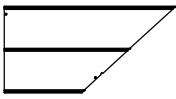

Pais d'origine: Chine

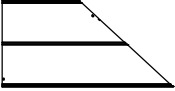
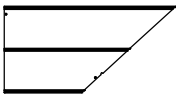

AS	P00060199004	Poutre Supérieure du Grand Toit d'en Haut (Côté Court)	4	
AT	P00060198905	Poutre Supérieure du Grand Toit d'en Haut (Côté Long)	4	
AU	P00060200904	Poutre Centrale du toit Supérieur du Grand Toit (Côté Long)	8	
AV	P00060200004	Poutre Supérieure du Grand Toit (Côté Court)	4	
AW	P00060199905	Poutre Supérieure du Grand Toit (Côté Long)	4	
AX	P00060201304	Solin du Panneau Gauche du Grand Toit (Côté Court)	2	
AY	P00060201705	Solin du Panneau Droit du Grand Toit (Côté Court)	2	
BA	P00060201205	Solin du Panneau Gauche du Grand Toit (Côté Long)	2	
BB	P00060201604	Solin du Panneau Panel du Grand Toit (Côté Long)	2	
BC	P00060201804	Solin du Panneau Central du Grand Toit (Côté XXXL)	4	
BD	P00070103504	Panneau Central du Grand Toit	6	
BE	P00070102105	Grand Panneau du Grand Toit (Gauche)	4	
BF	P00070102605	Grand Panneau du Grand Toit (Droit)	4	

Country of Origin: China



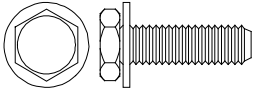
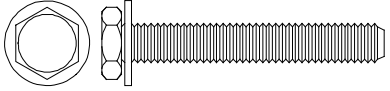
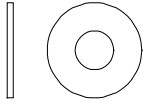
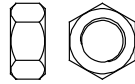
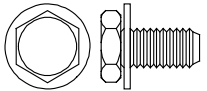

Pais d'origine: Chine

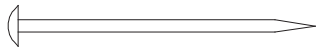
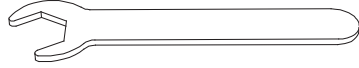
BG	P00070101405	Big Roof Small Panel (Left Middle)	4	
BJ	P00070101605	Big Roof Small Panel (Right Middle)	4	
BK	P00070101005	Big Roof Small Panel (Left)	4	
BL	P00070101205	Big Roof Small Panel (Right)	4	
BM	P00080034404	Big Roof Inclined Beam Cap	4	

BG	P00070101405	Petit Panneau du Grand Toit (Milieu Gauche)	4	
BJ	P00070101605	Petit Panneau du Grand Toit (Milieu Droit)	4	
BK	P00070101005	Petit Panneau du Grand Toit (Gauche)	4	
BL	P00070101205	Petit Panneau du Grand Toit (Droit)	4	
BM	P00080034404	Opercule de la Poutre Inclignée du Grand Toit	4	

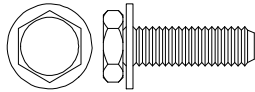
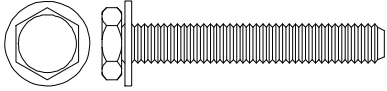
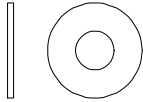
Hardware Pack					
Label	Part Number	Description	Qty	Add	Part Image
H1	H100010047	Bolt M6*20	382	20	
H2	H100010046	Bolt M6*40	18	1	
H3	H050030001	Flat washer M6	16	1	
H4	H040010004	Nut M6	16	1	
H5	H100010147	Bolt M6*12	30	2	
HH	P00220034001	Black Plastic Buckle	20	1	
HS	H070010003	Stake $\Phi 8*180$	8	0	
HW	H090010017	Wrench M6	2	0	

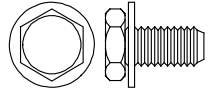
Country of Origin: China
Pais d'origine: Chine

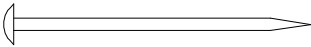
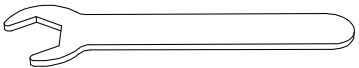
Pack Quincaillerie					
Étiquette	Numéro de la Pièce	Description	Quantité	Add	Numéro de la Pièce Diagramme
H1	H100010047	Boulon M6*20	382	20	
H2	H100010046	Boulon M6*40	18	1	
H3	H050030001	Rondelle plate M6	16	1	
H4	H040010004	Nut M6	16	1	
H5	H100010147	Boulon M6*12	30	2	
HH	P00220034001	Boucle en plastique noir	20	1	
HS	H070010003	Piquet $\Phi 8*180$	8	0	
HW	H090010017	Clé M6	2	0	

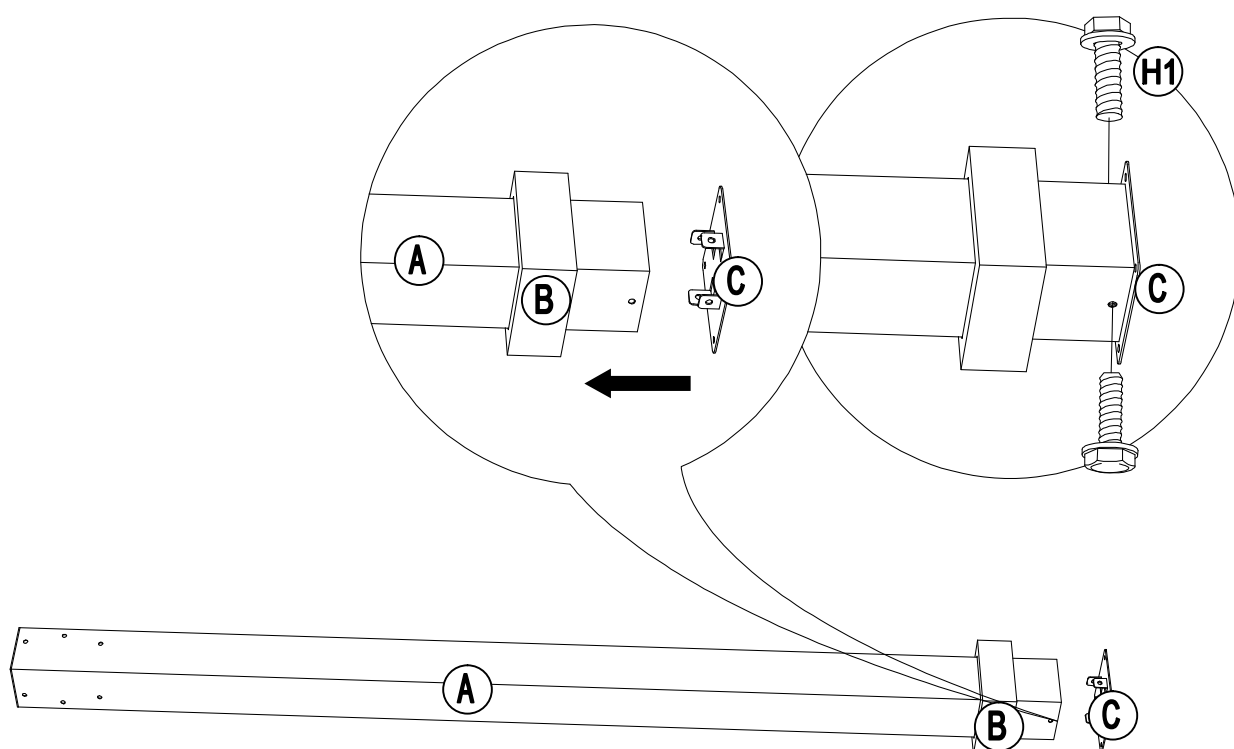
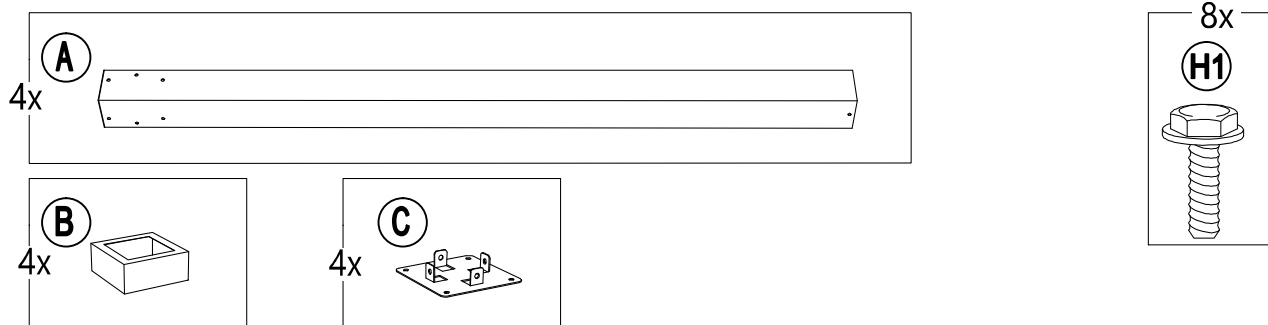
1

2

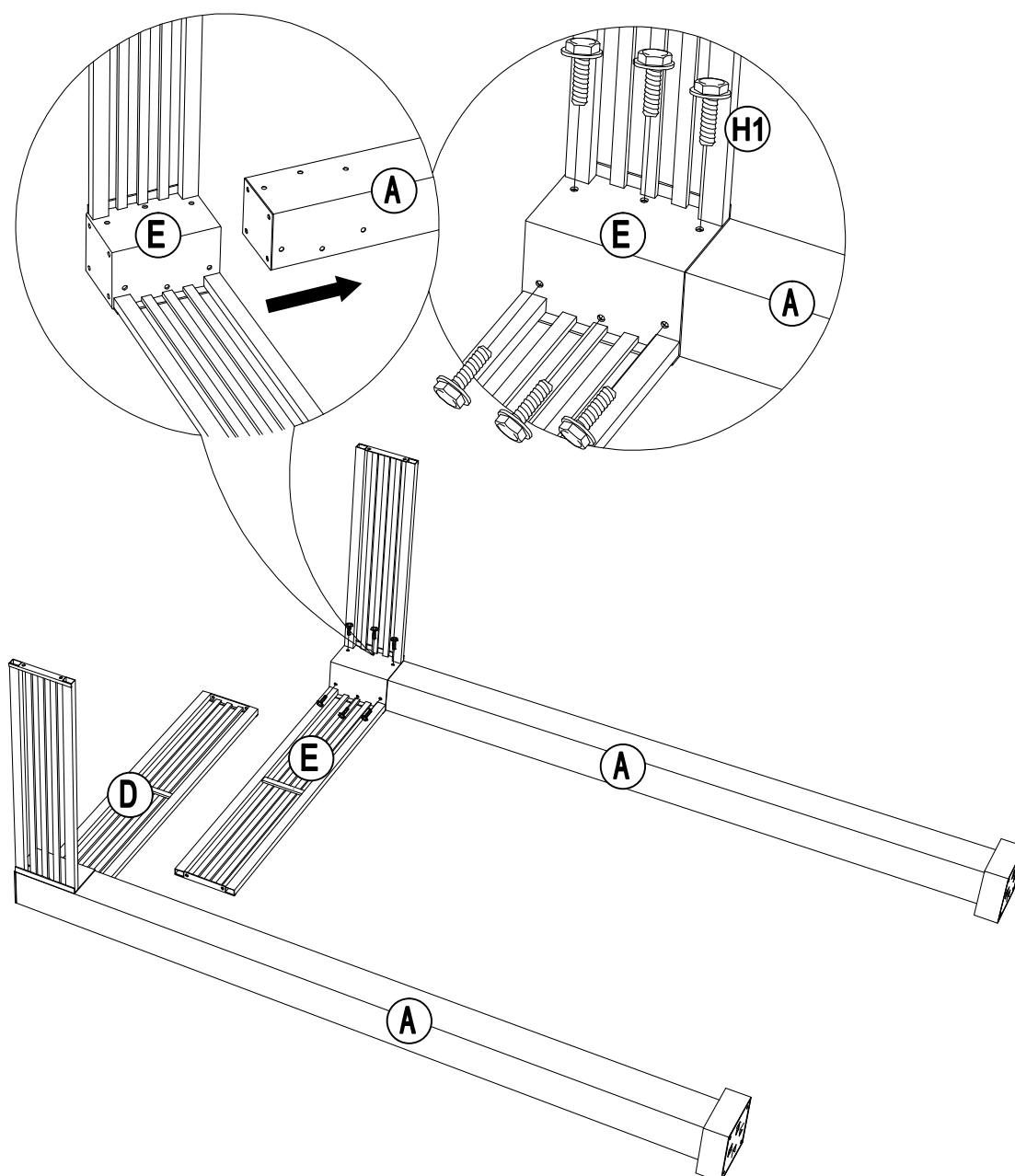
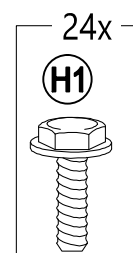
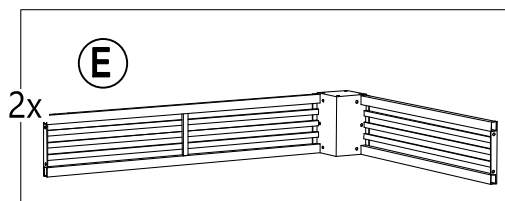
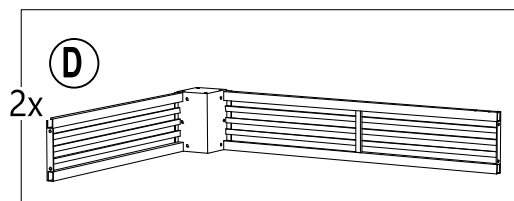

Country of Origin: China
Pais d'origine: Chine

3

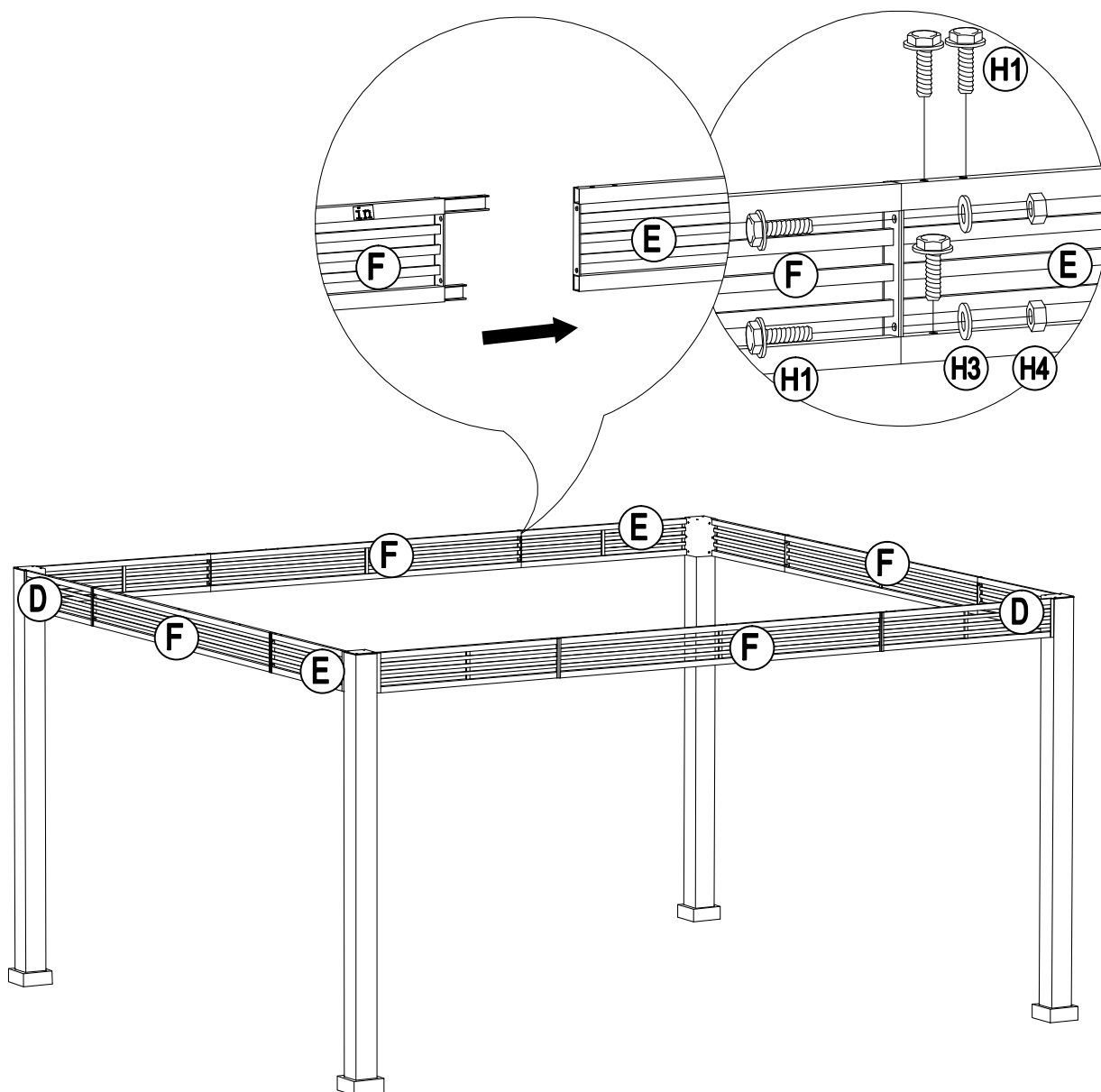
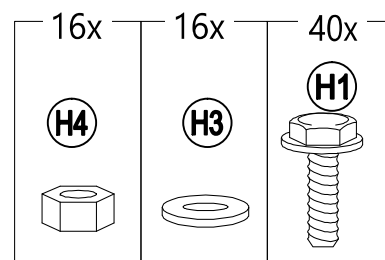
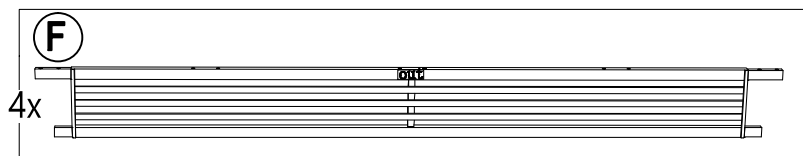

Country of Origin: China
 Pais d'origine: Chine

4

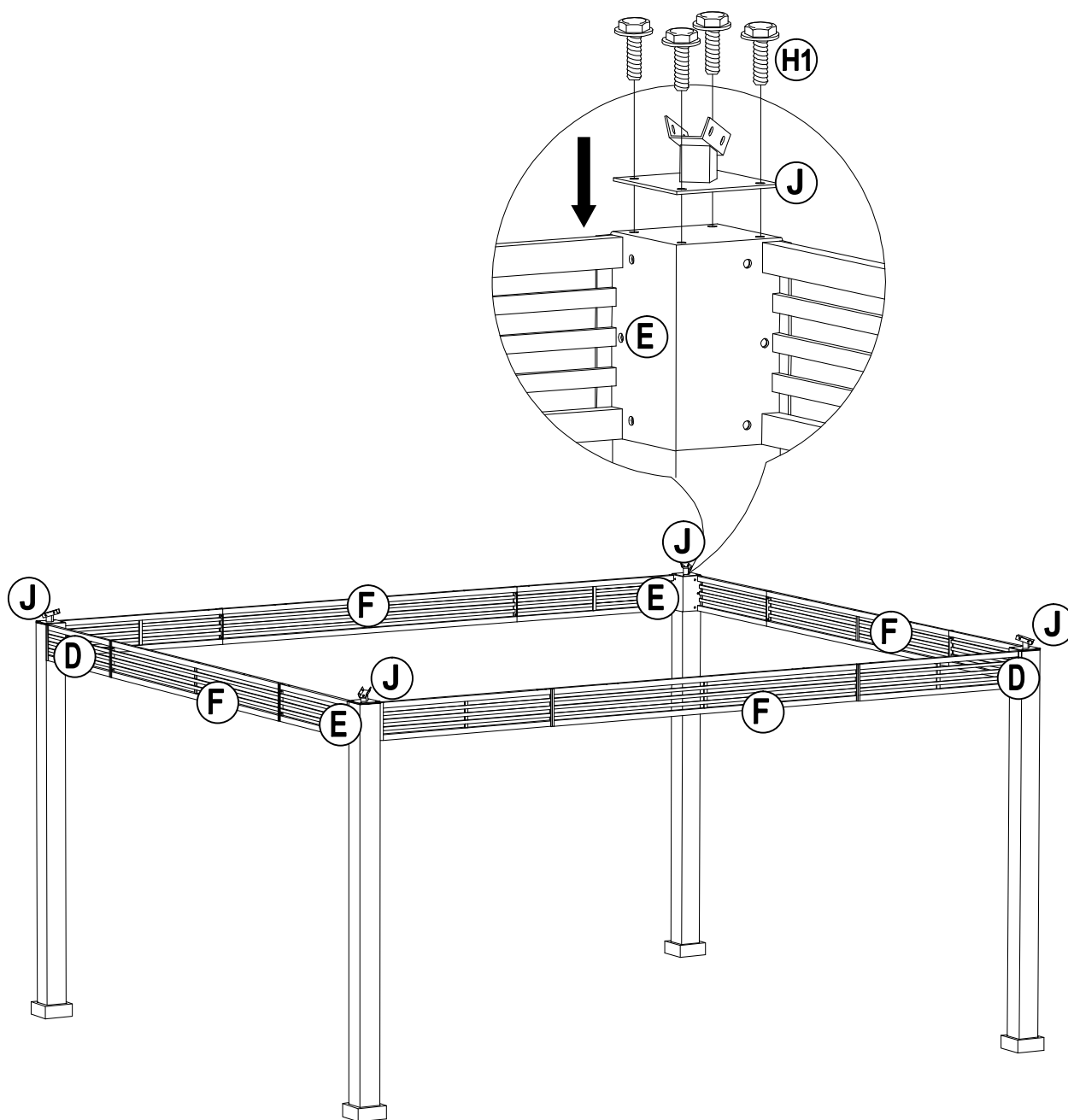
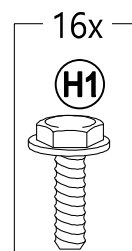
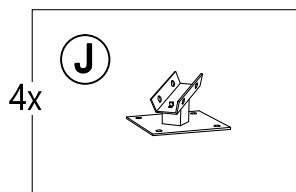

Country of Origin: China
Pais d'origine: Chine

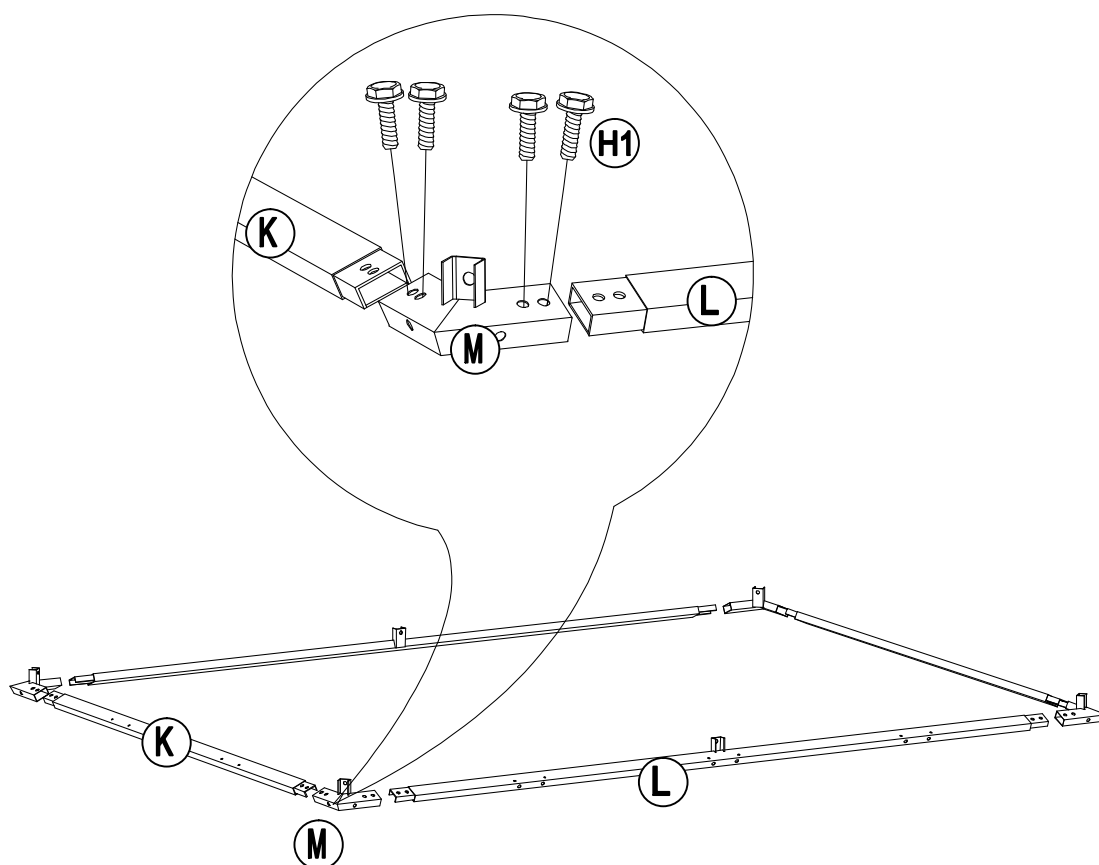
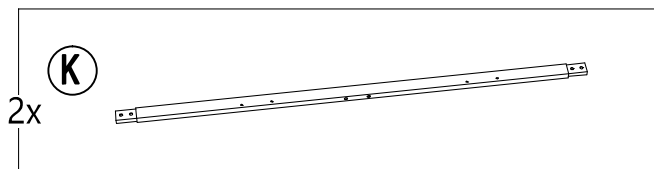
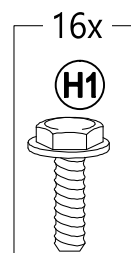
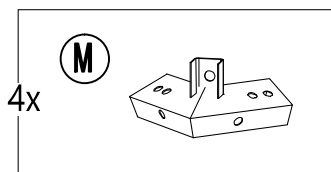
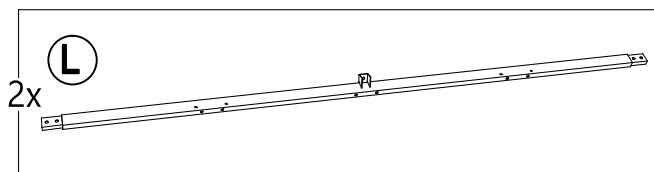
5

Country of Origin: China
Pais d'origine: Chine

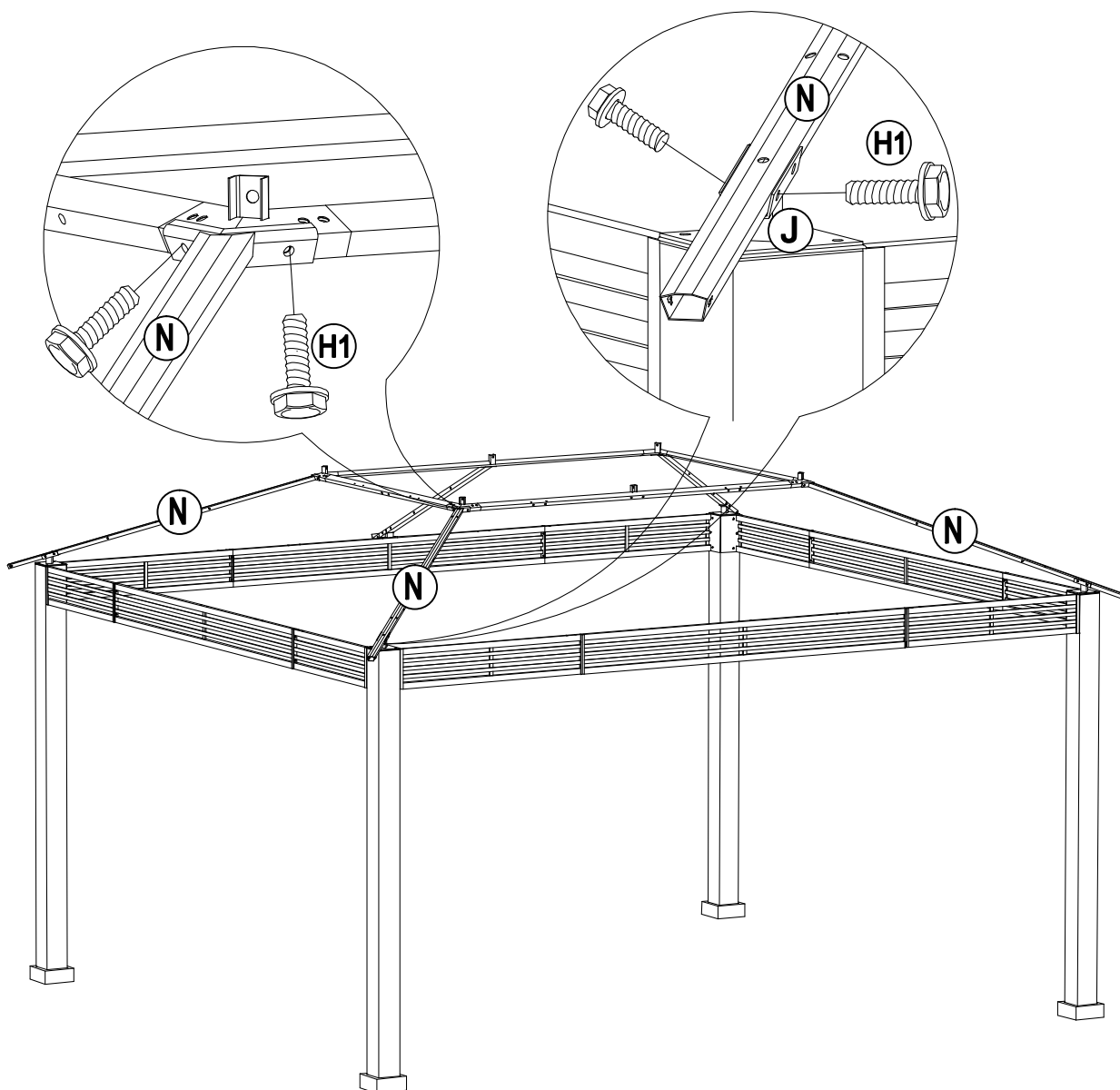
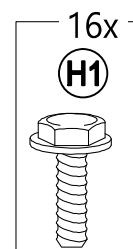
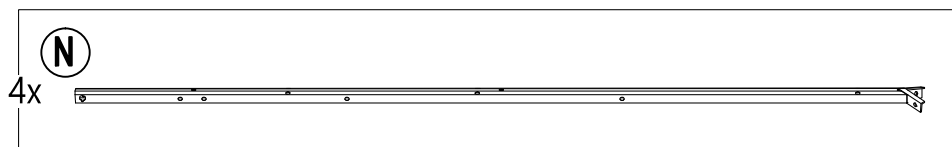
6

Country of Origin: China
Pais d'origine: Chine

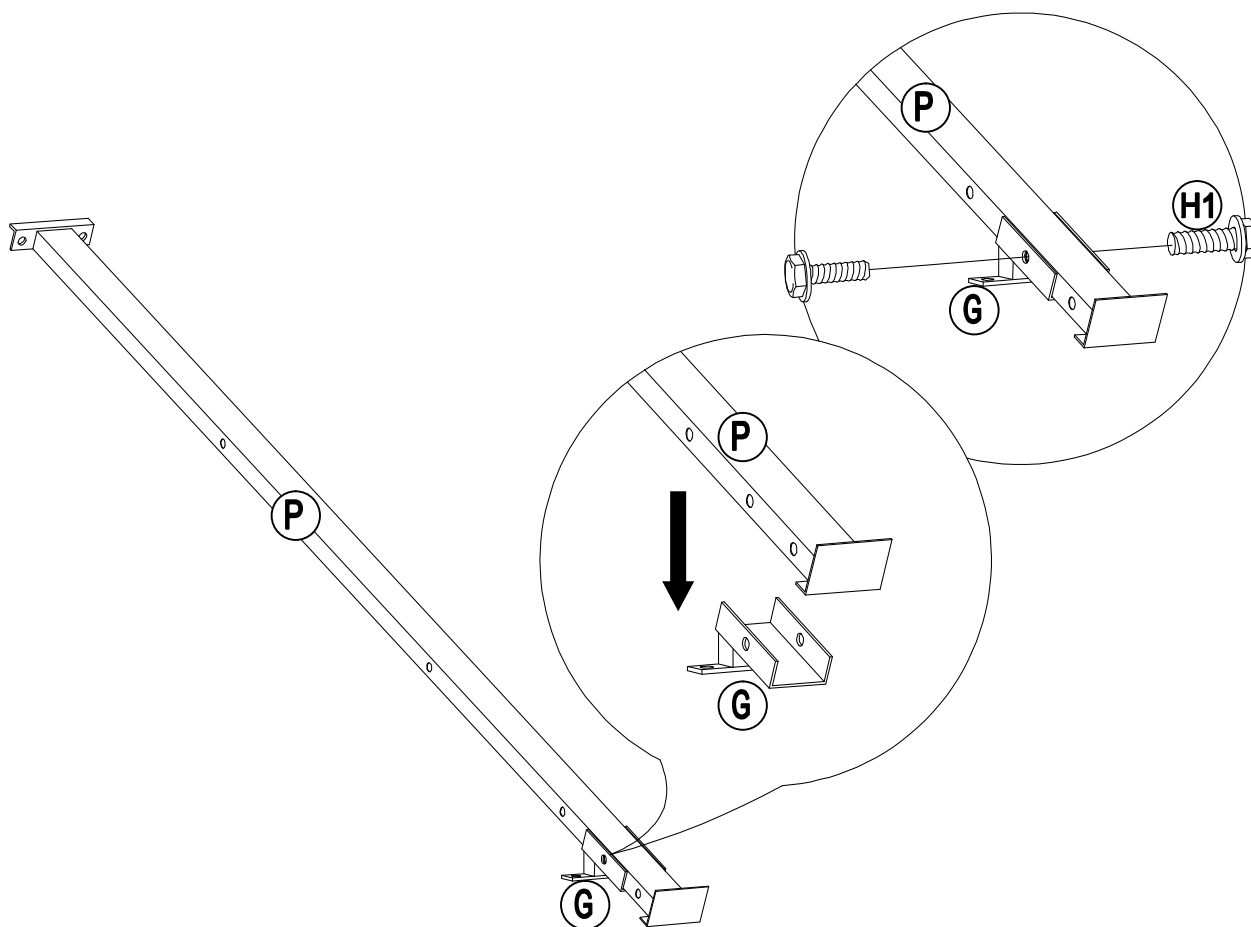
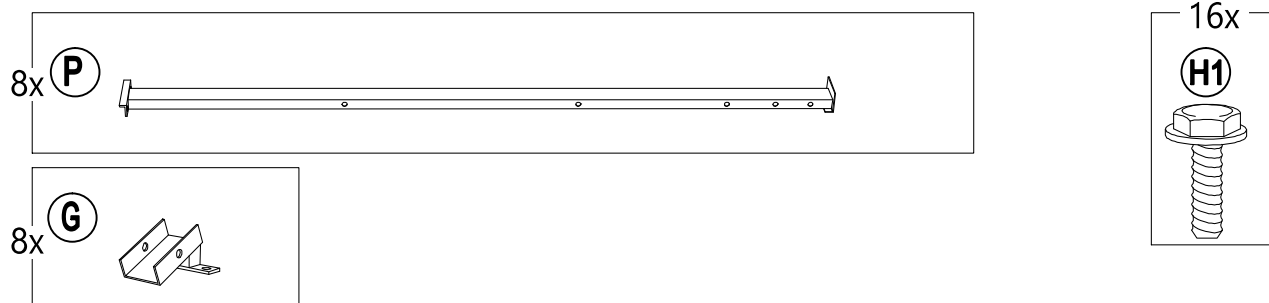
7

Country of Origin: China
Pais d'origine: Chine

8

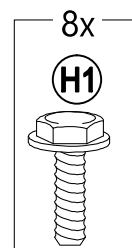

Attach the lower connecting piece of the middle beam to the middle screen, do not lock the screws / Fixez la pièce de connexion inférieure de la poutre centrale à l'écran central, ne verrouillez pas les vis

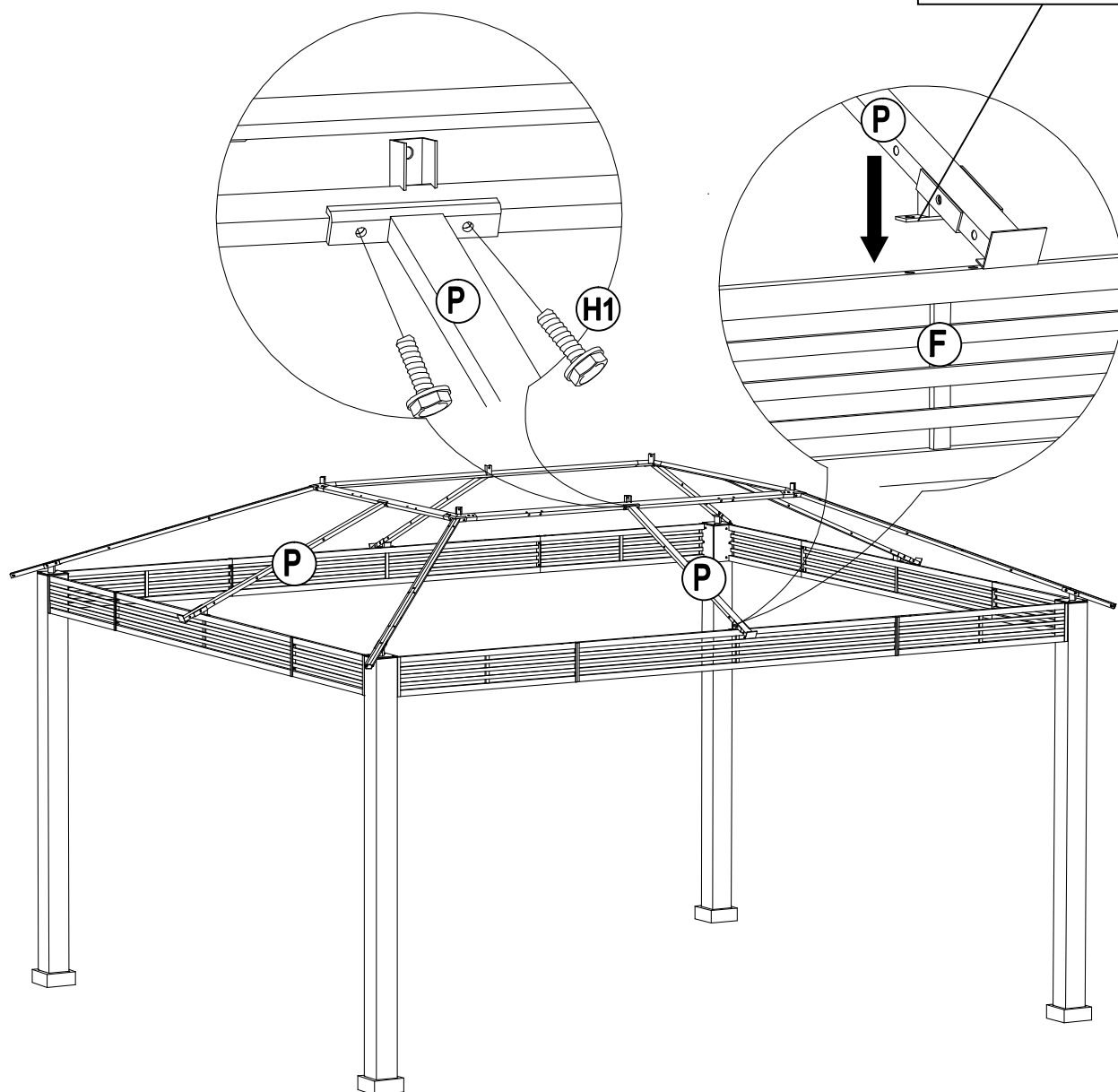

Country of Origin: China
Pais d'origine: Chine

9

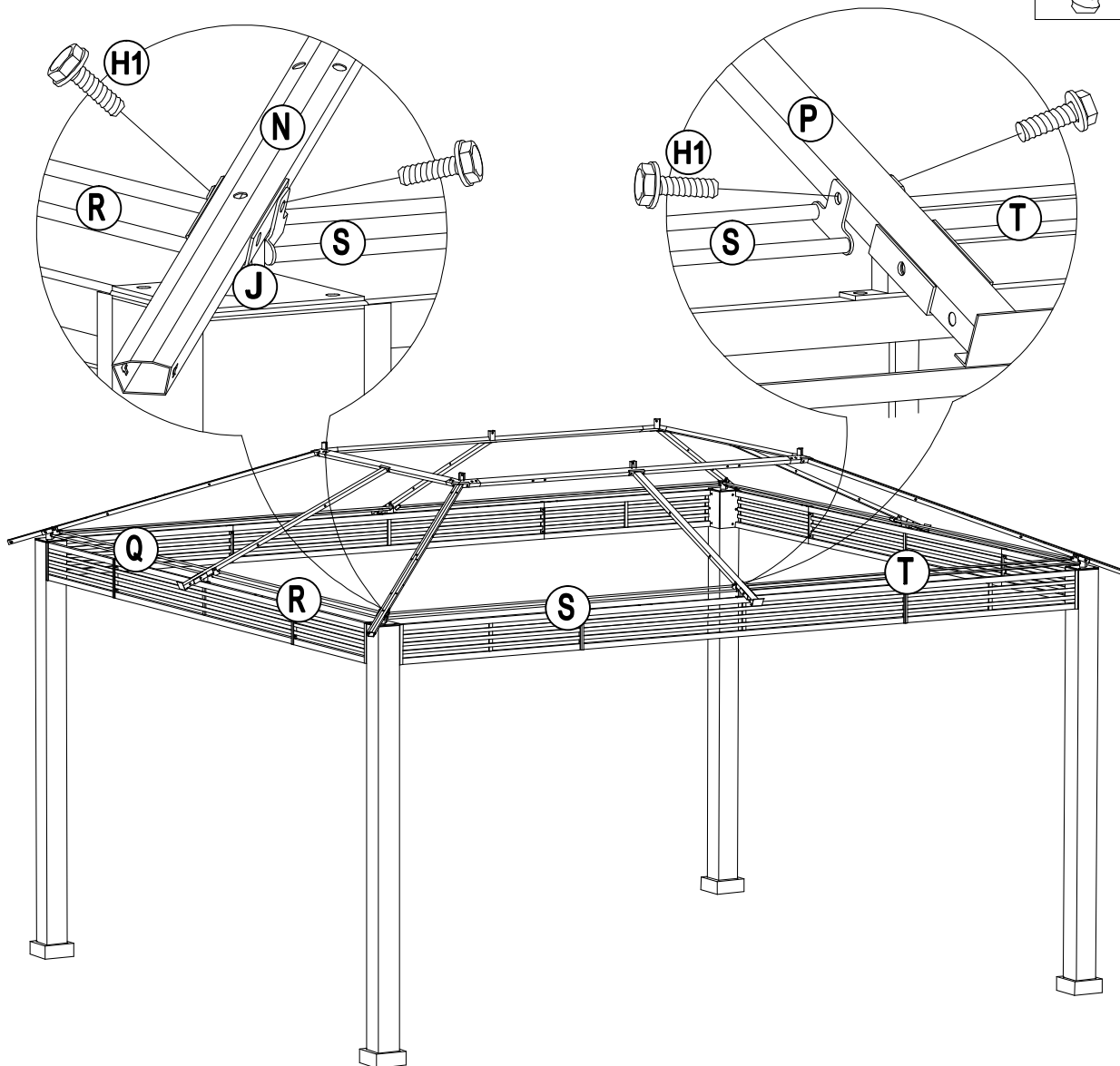
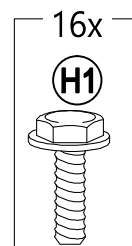

Country of Origin: China
 Pais d'origine: Chine

10

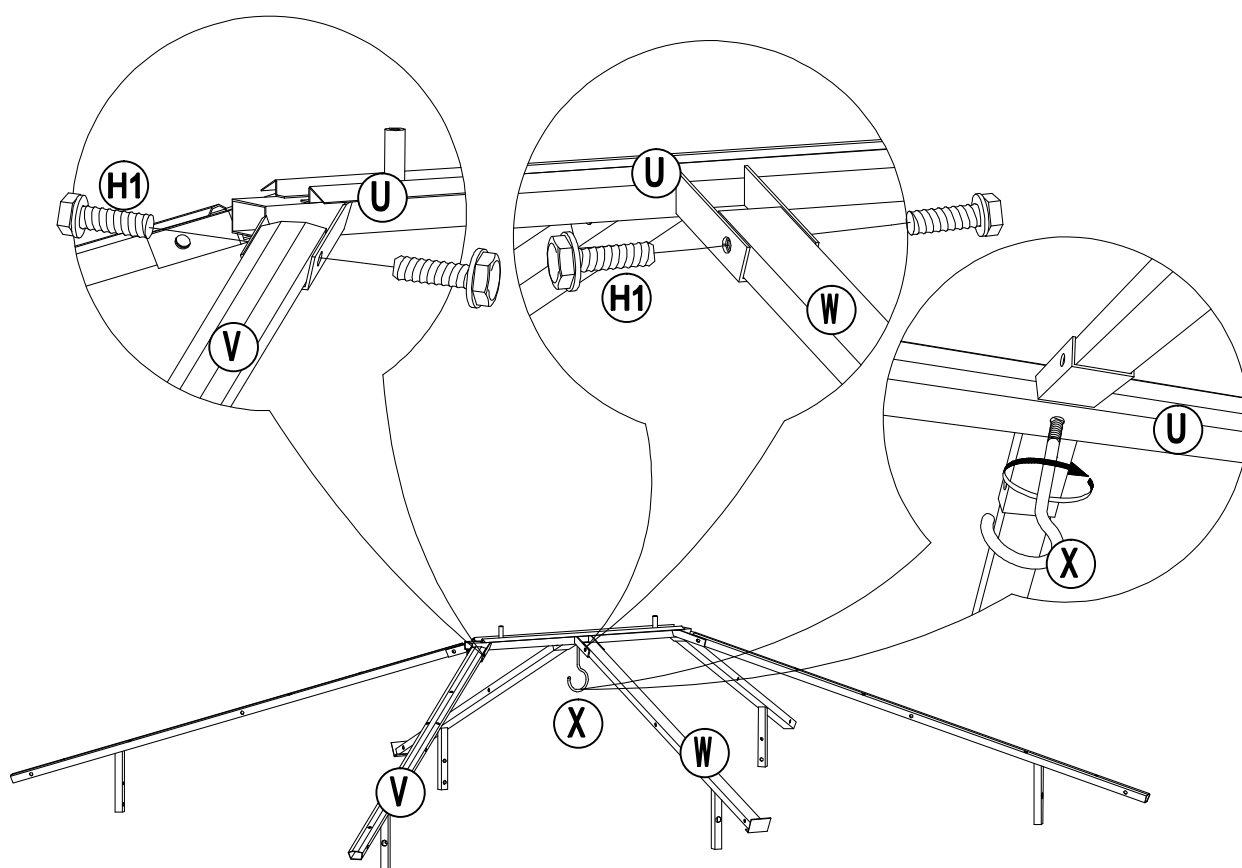
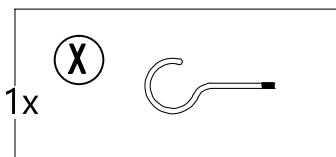
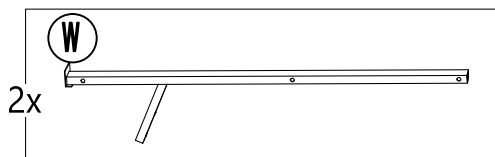
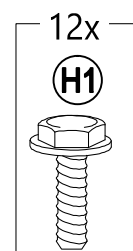
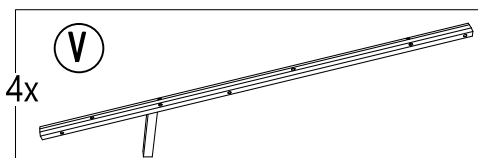
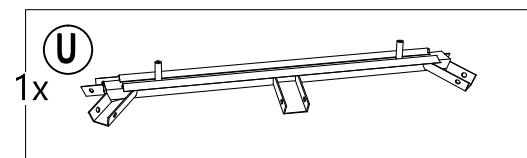

11

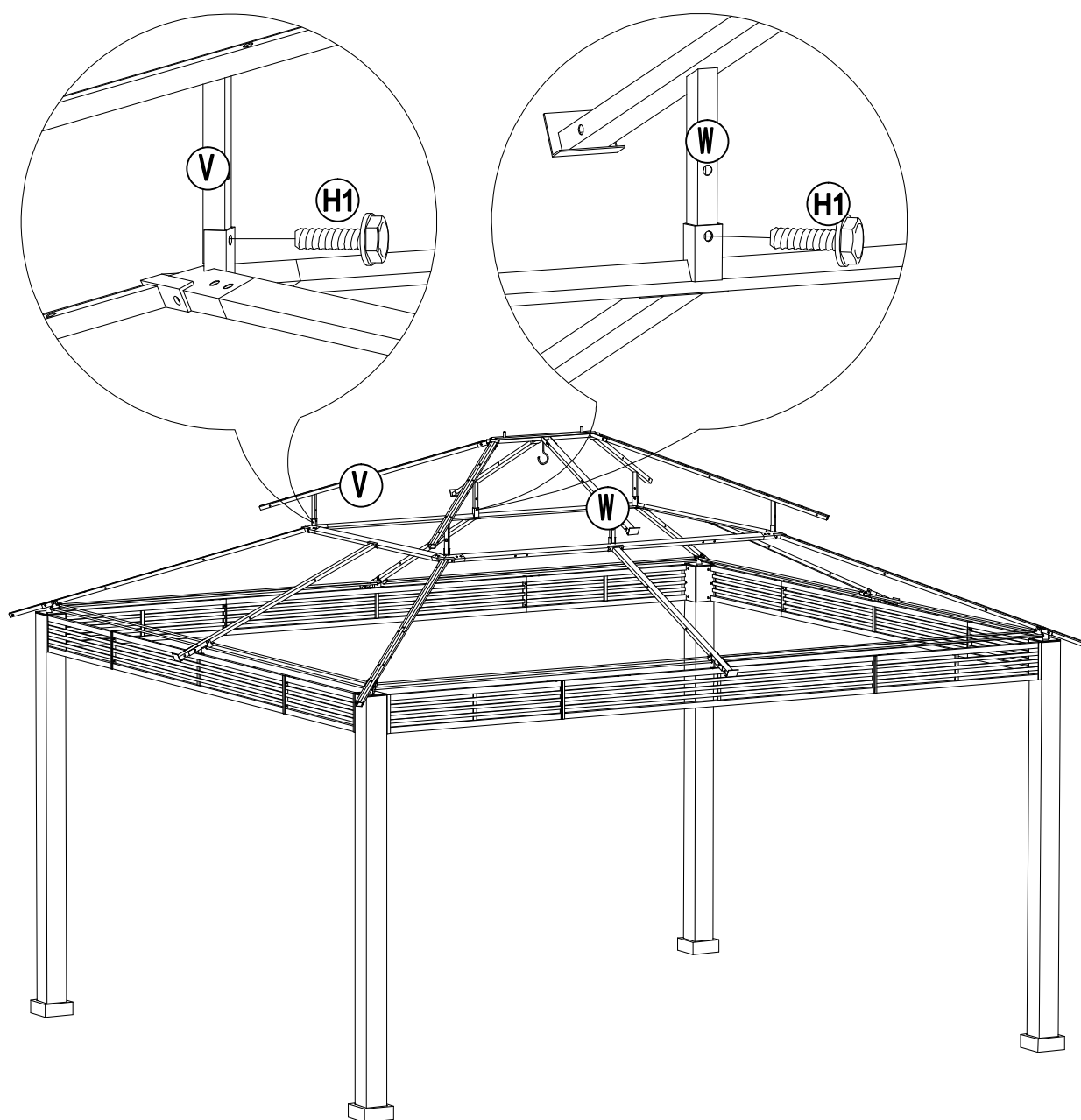
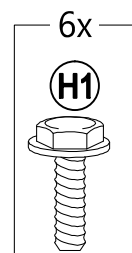
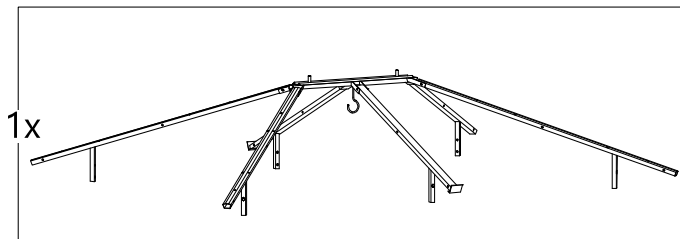

Country of Origin: China
Pais d'origine: Chine

12

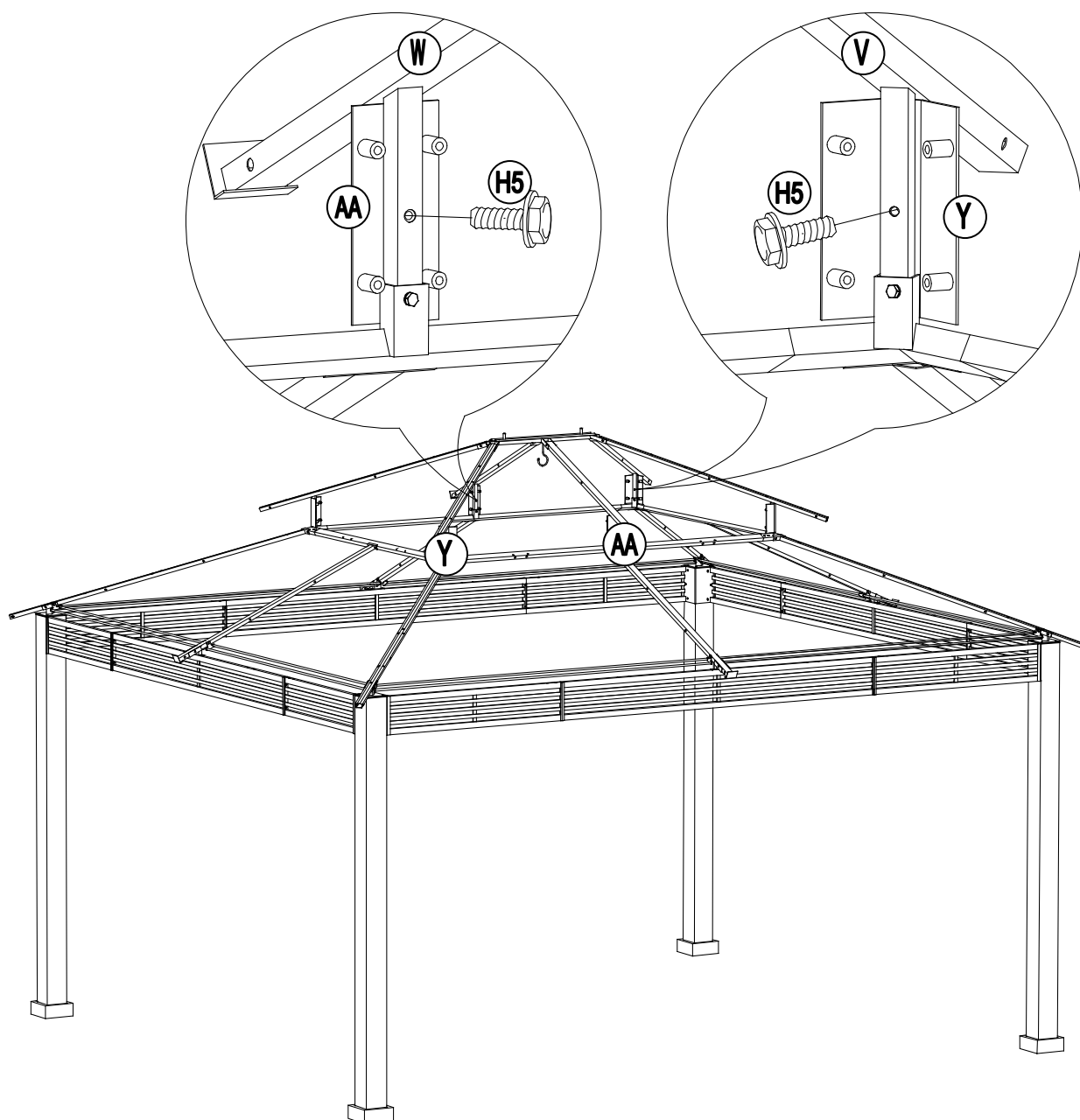
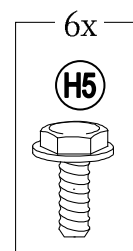
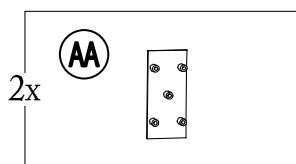
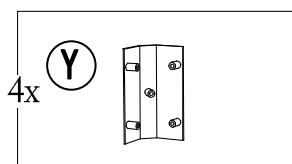

Country of Origin: China
Pais d'origine: Chine

13

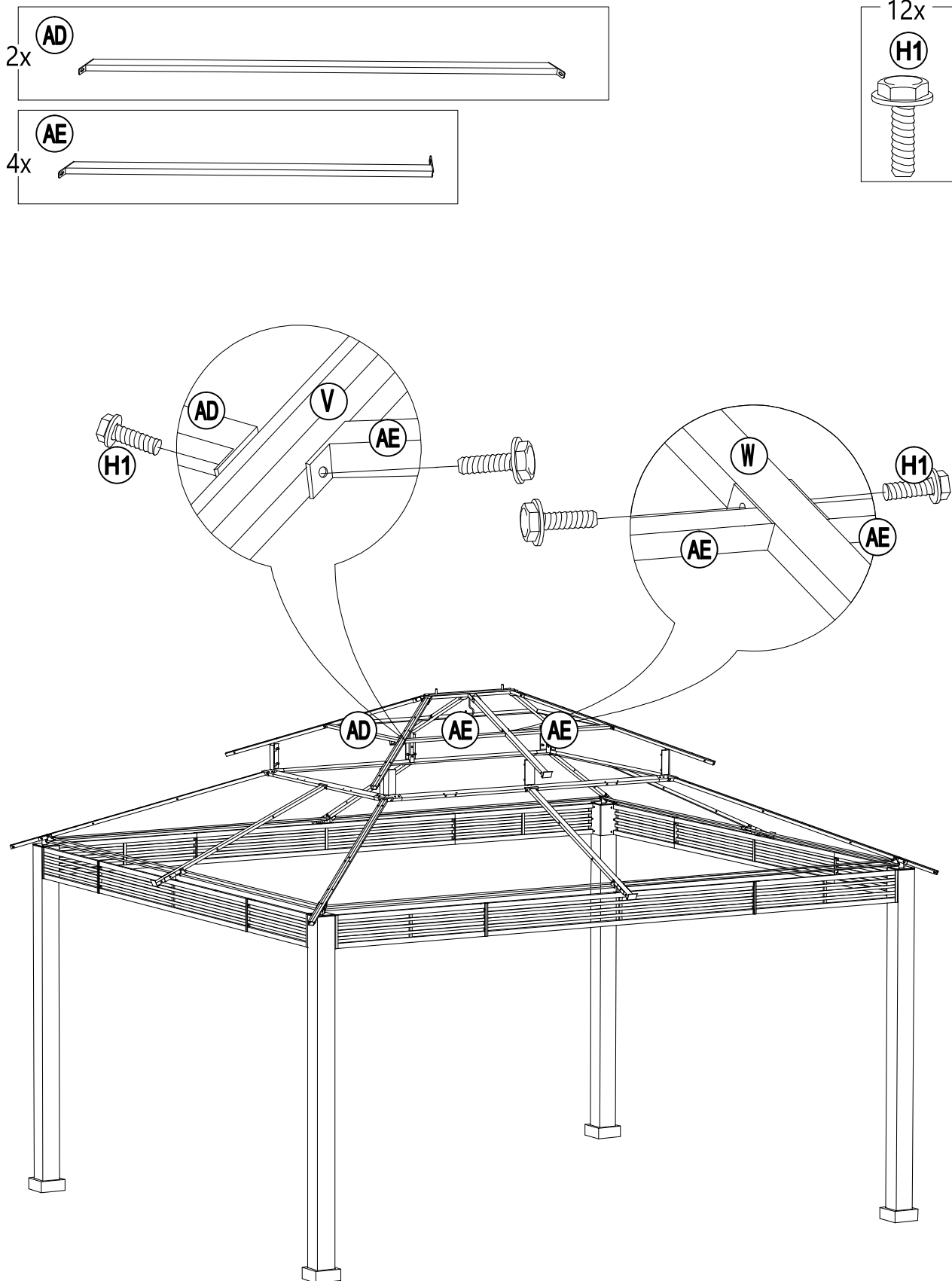

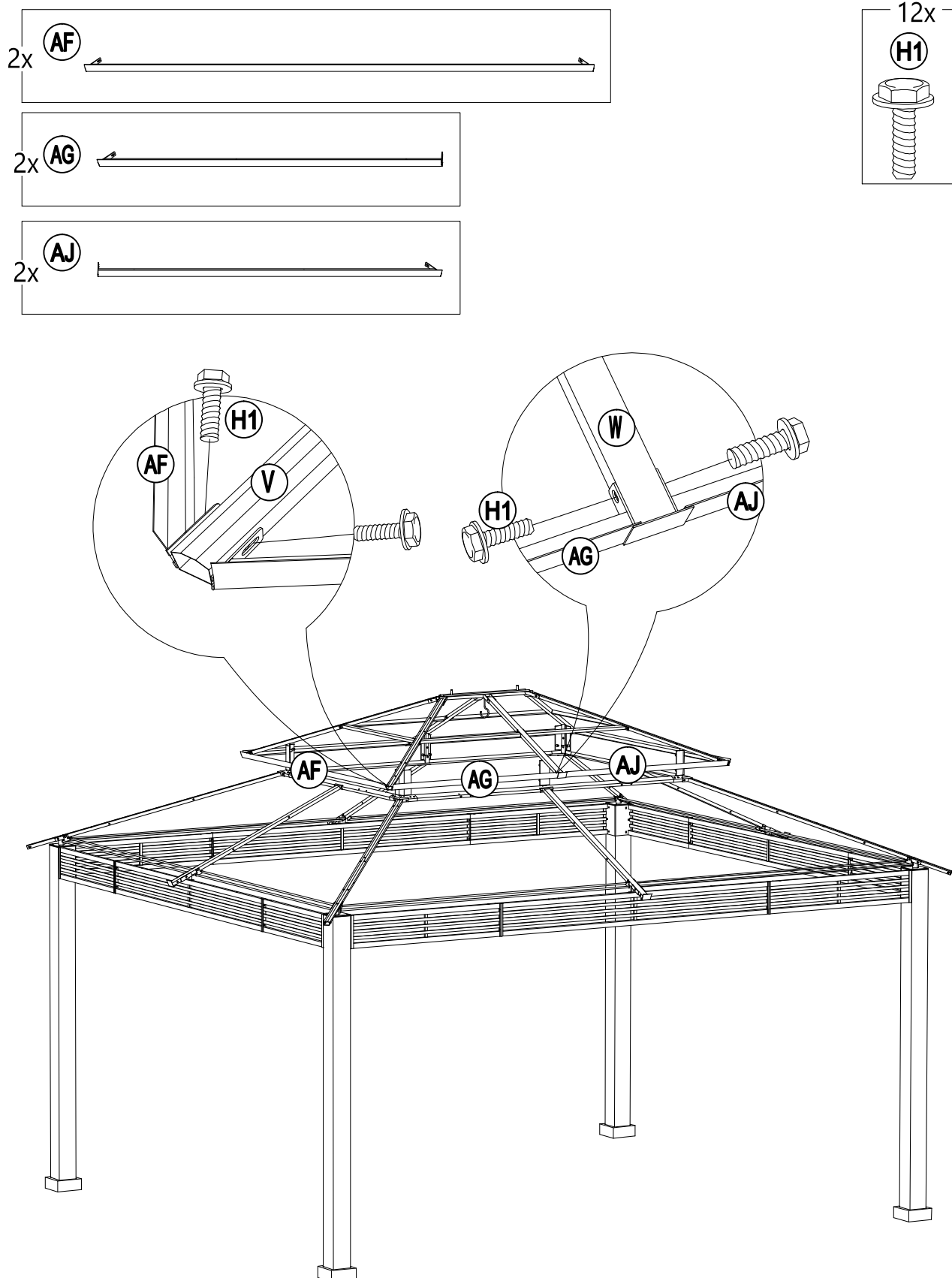
14

Country of Origin: China
Pais d'origine: Chine

15

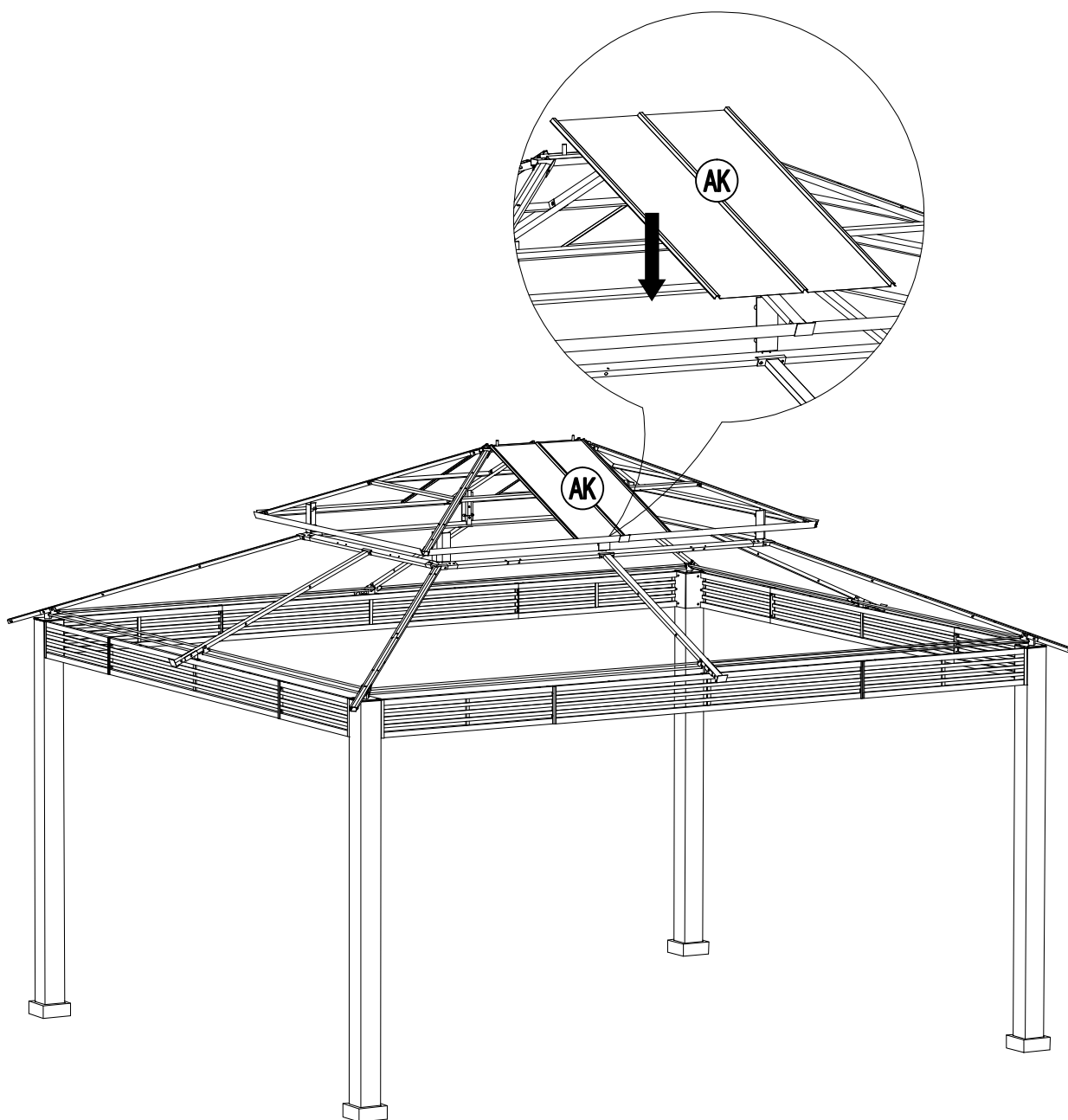
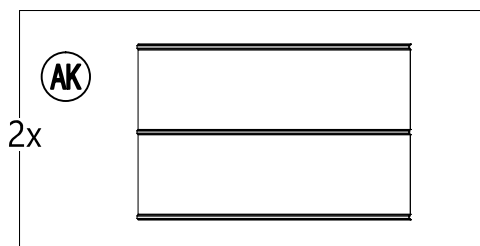

Country of Origin: China
Pais d'origine: Chine

16

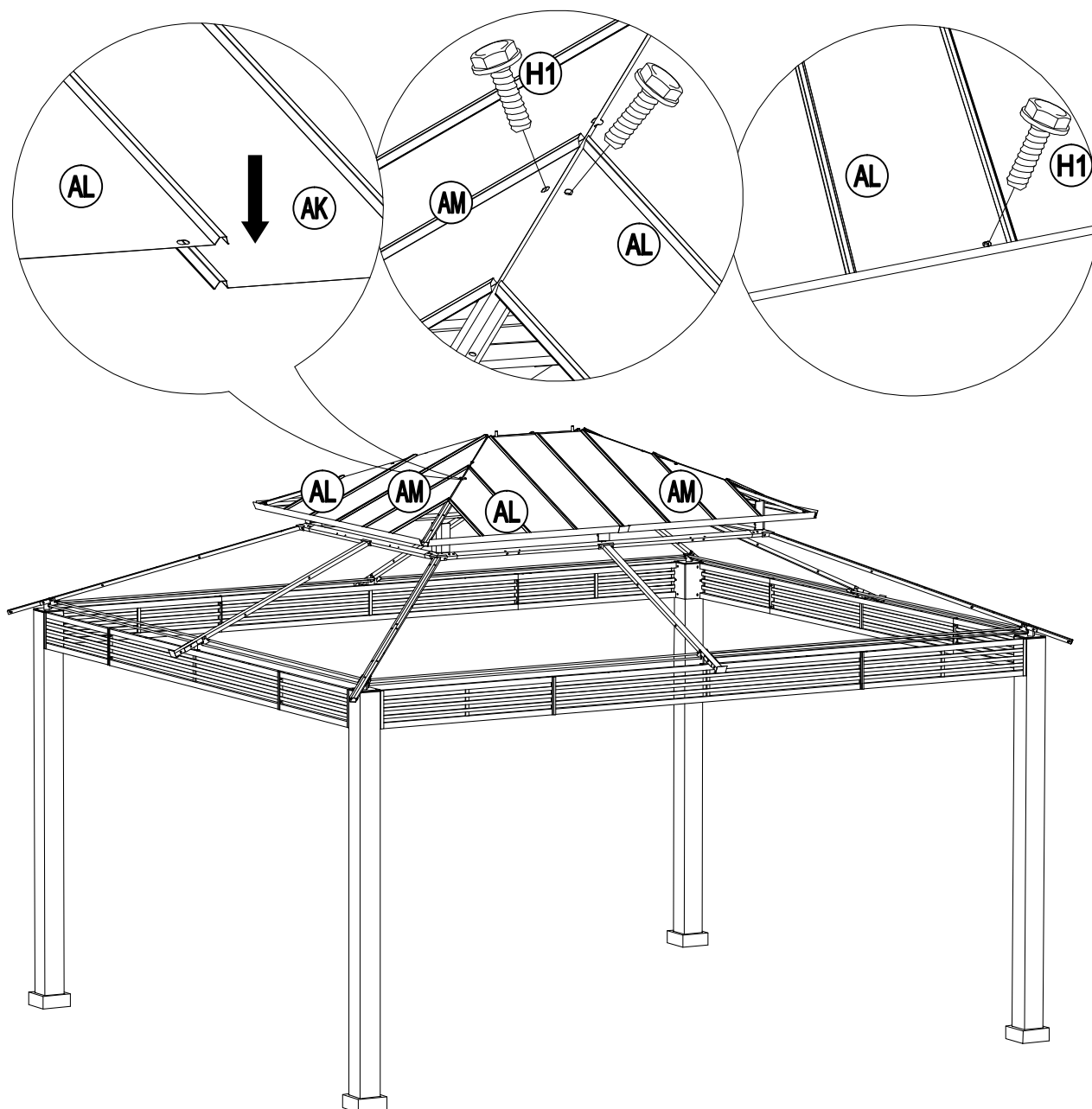
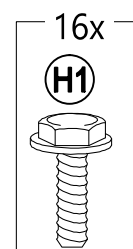
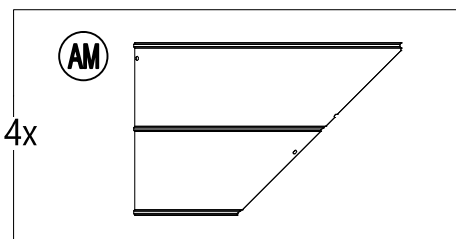
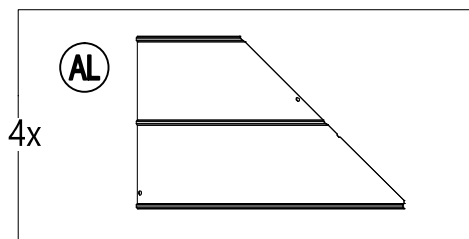

Country of Origin: China
 Pays d'origine: Chine

17

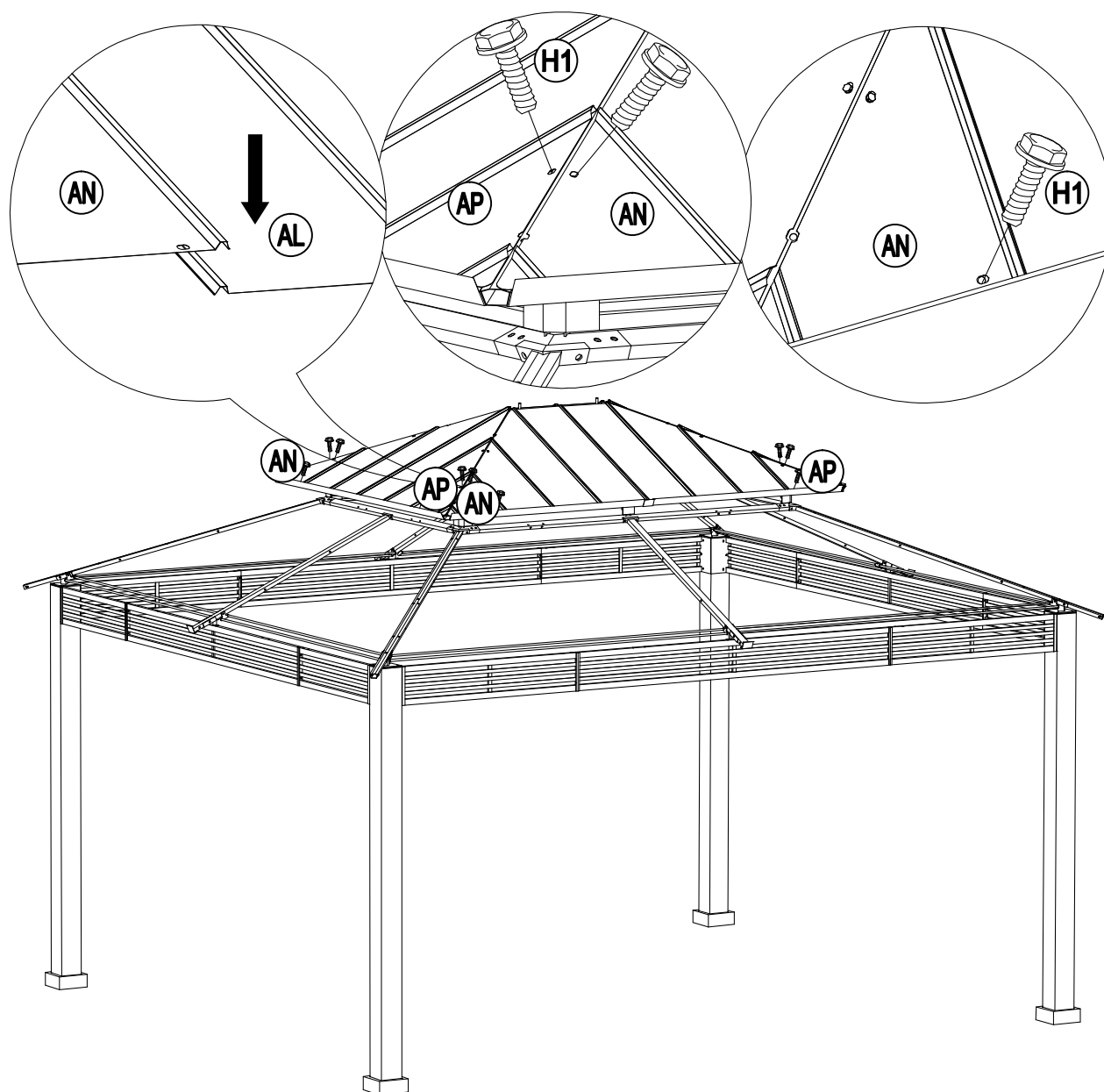
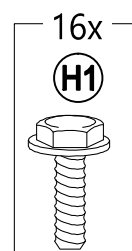
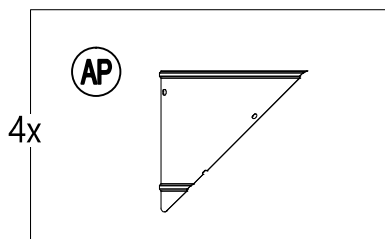
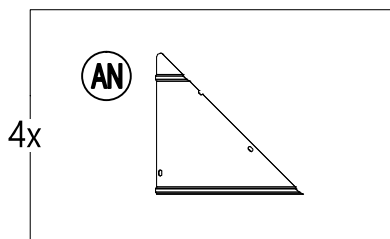

Country of Origin: China
 Pais d'origine: Chine

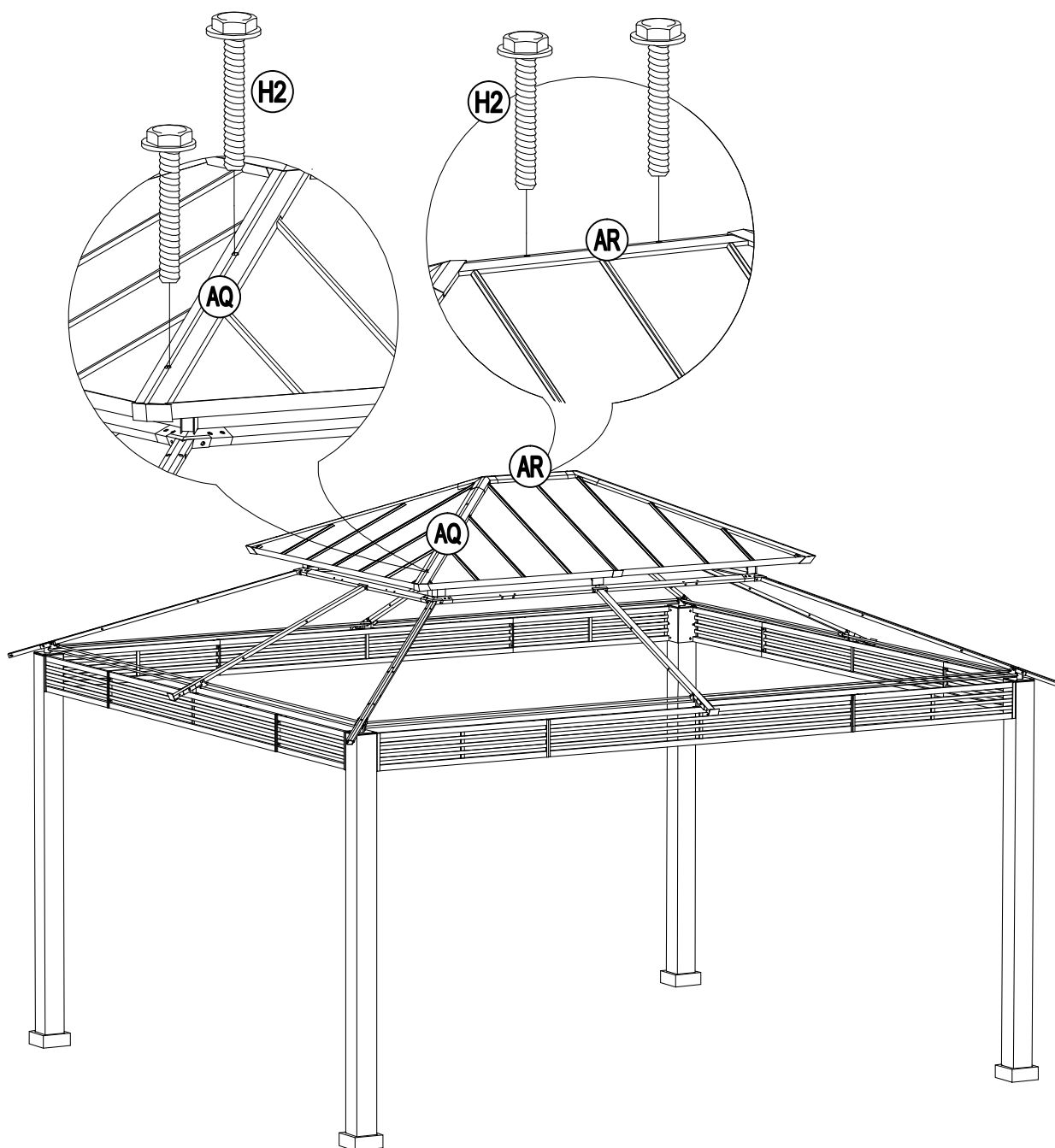
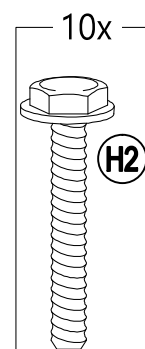
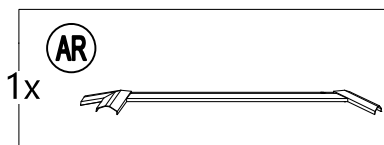
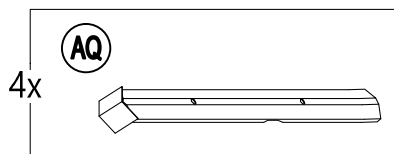
18

Country of Origin: China
Pais d'origine: Chine

19

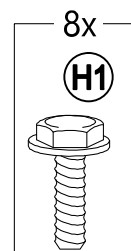

Attach the lower connecting piece of the middle beam to the middle screen, do not lock the screws / Fixez la pièce de connexion inférieure de la poutre centrale à l'écran central, ne verrouillez pas les vis

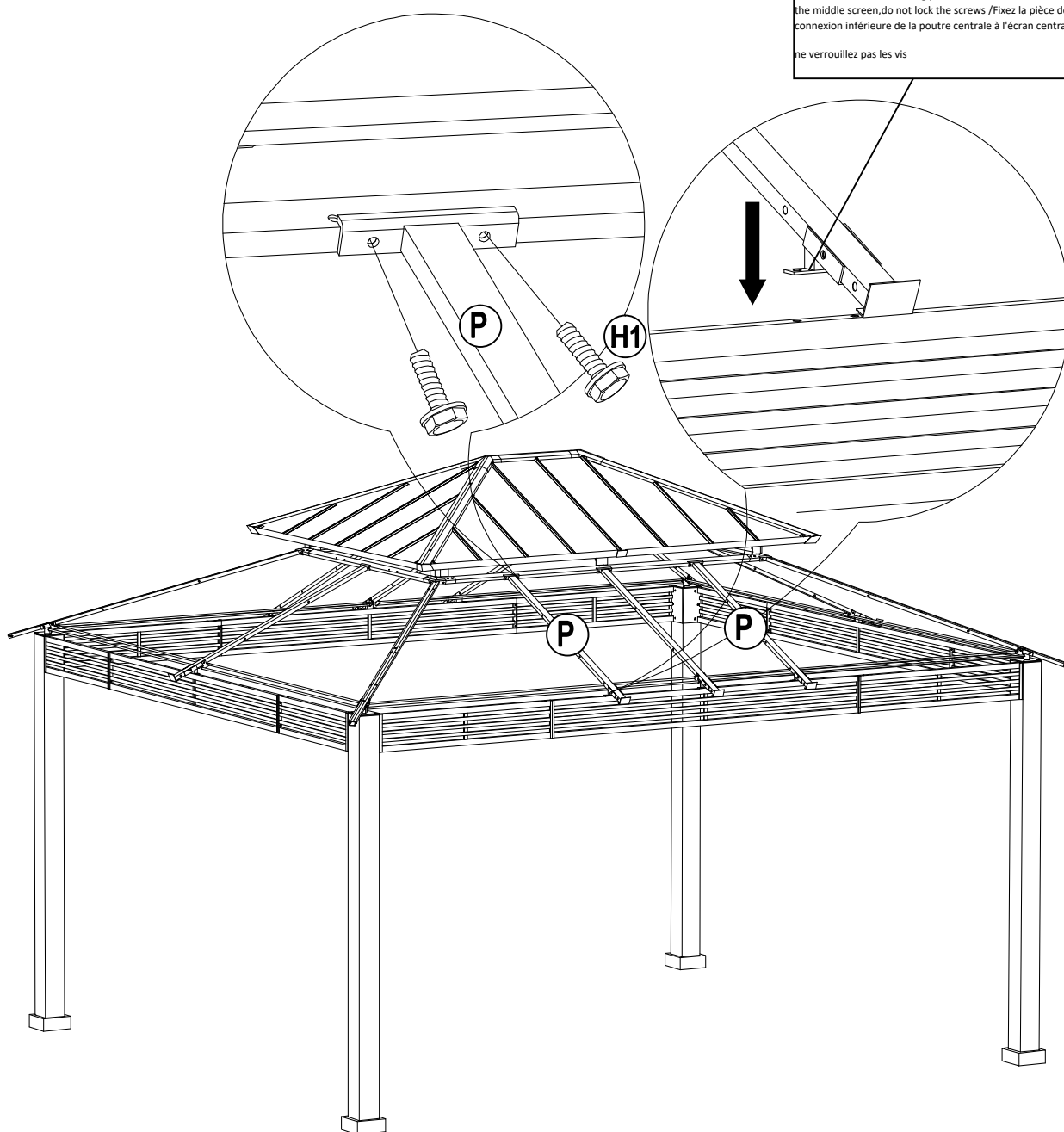

Country of Origin: China
Pais d'origine: Chine

20

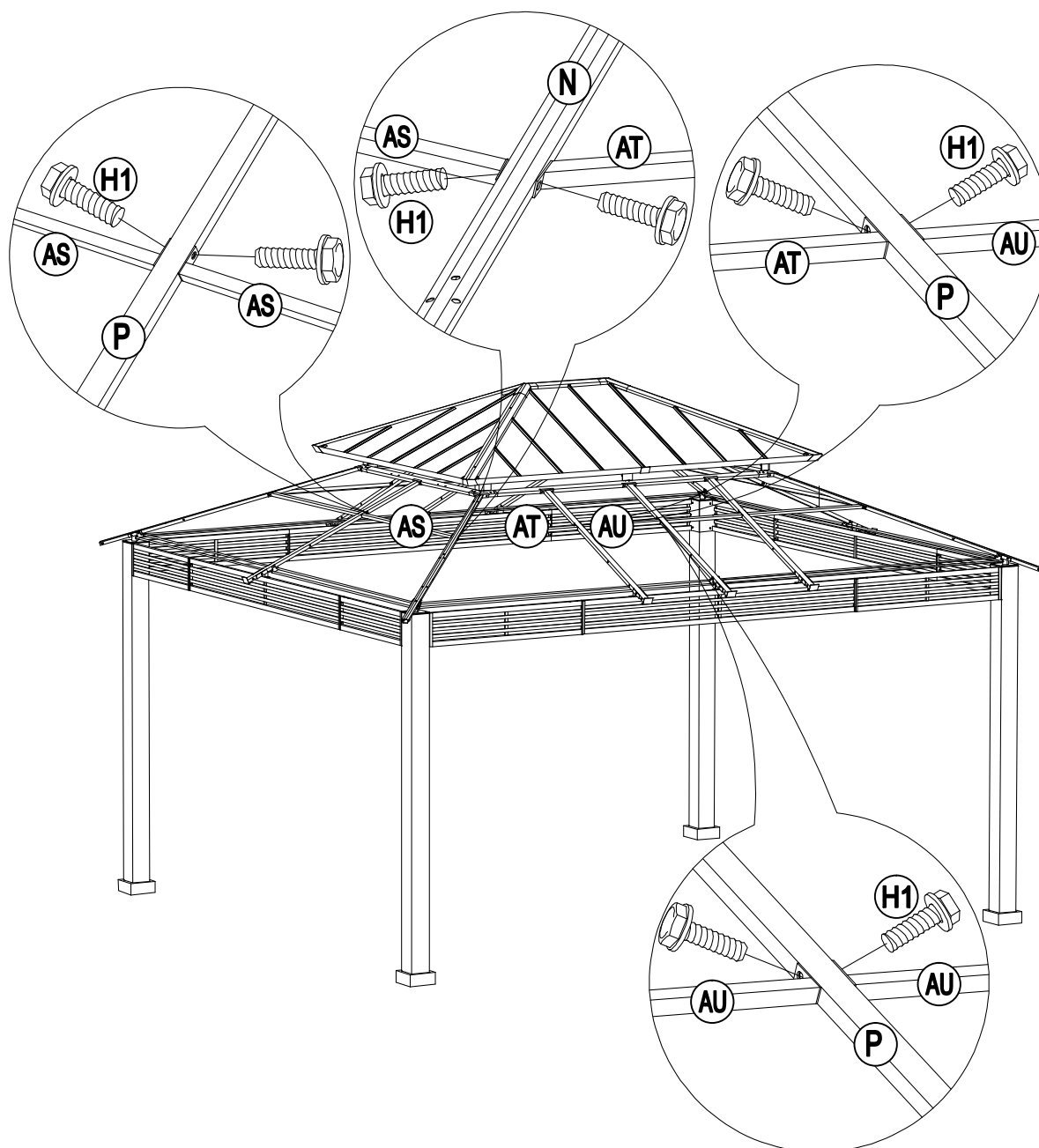
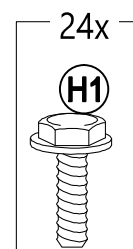
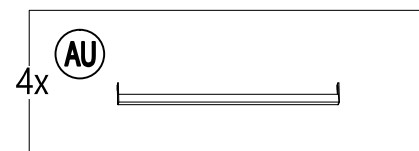
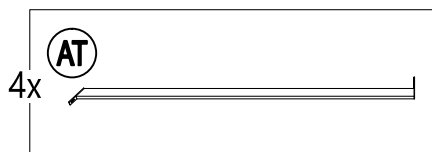
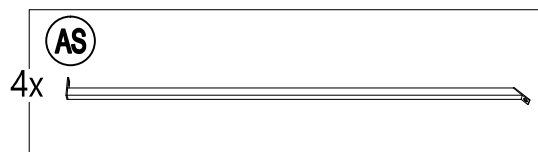

Country of Origin: China
 Pais d'origine: Chine

21

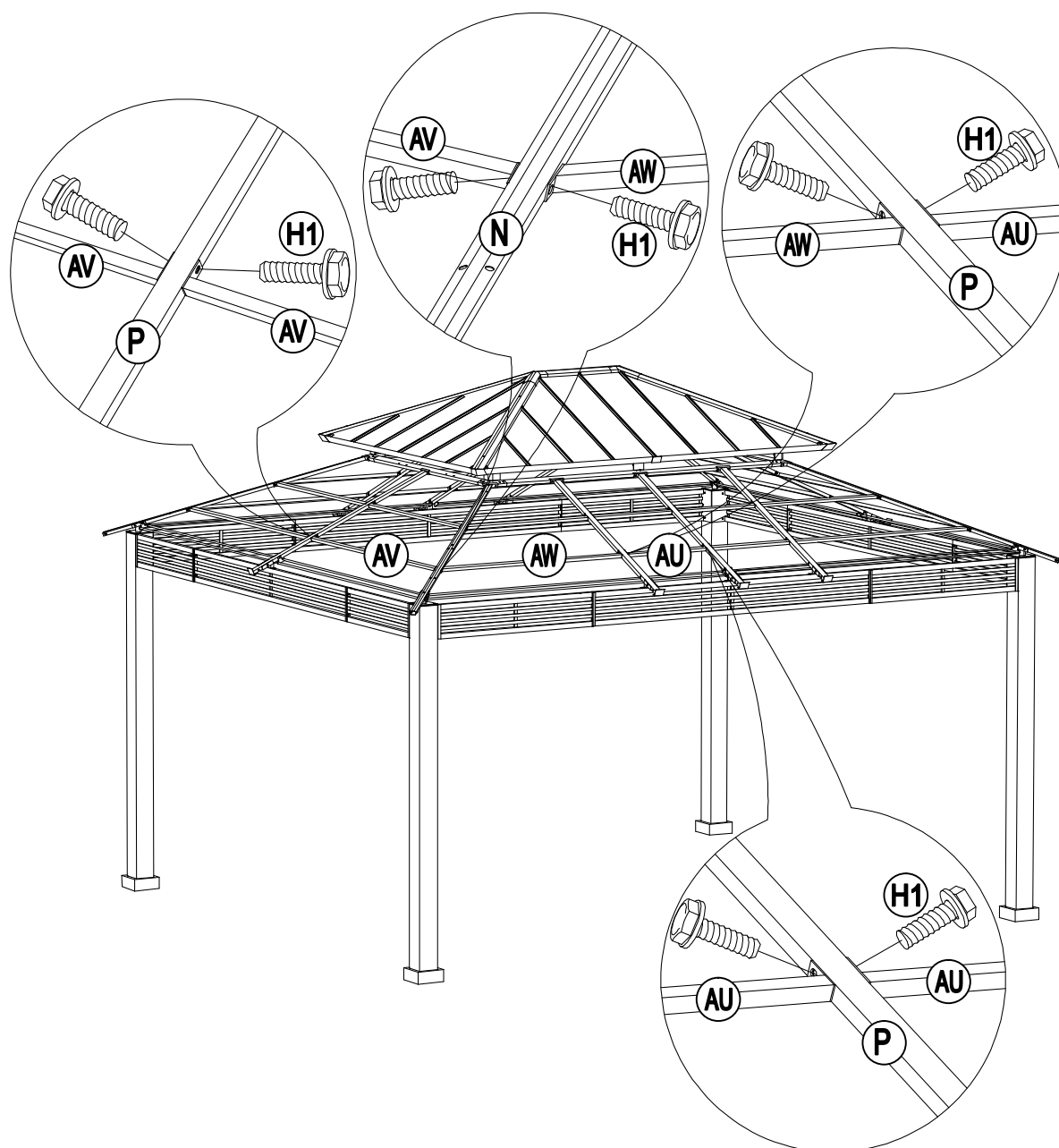
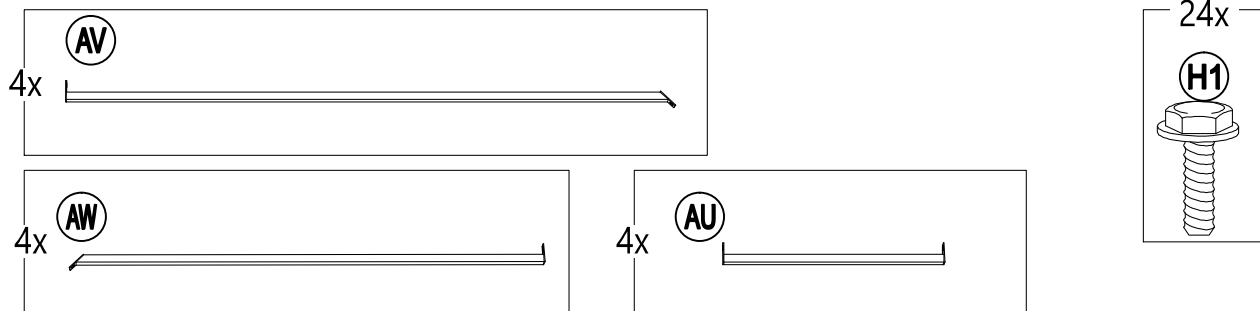

Country of Origin: China
 Pais d'origine: Chine

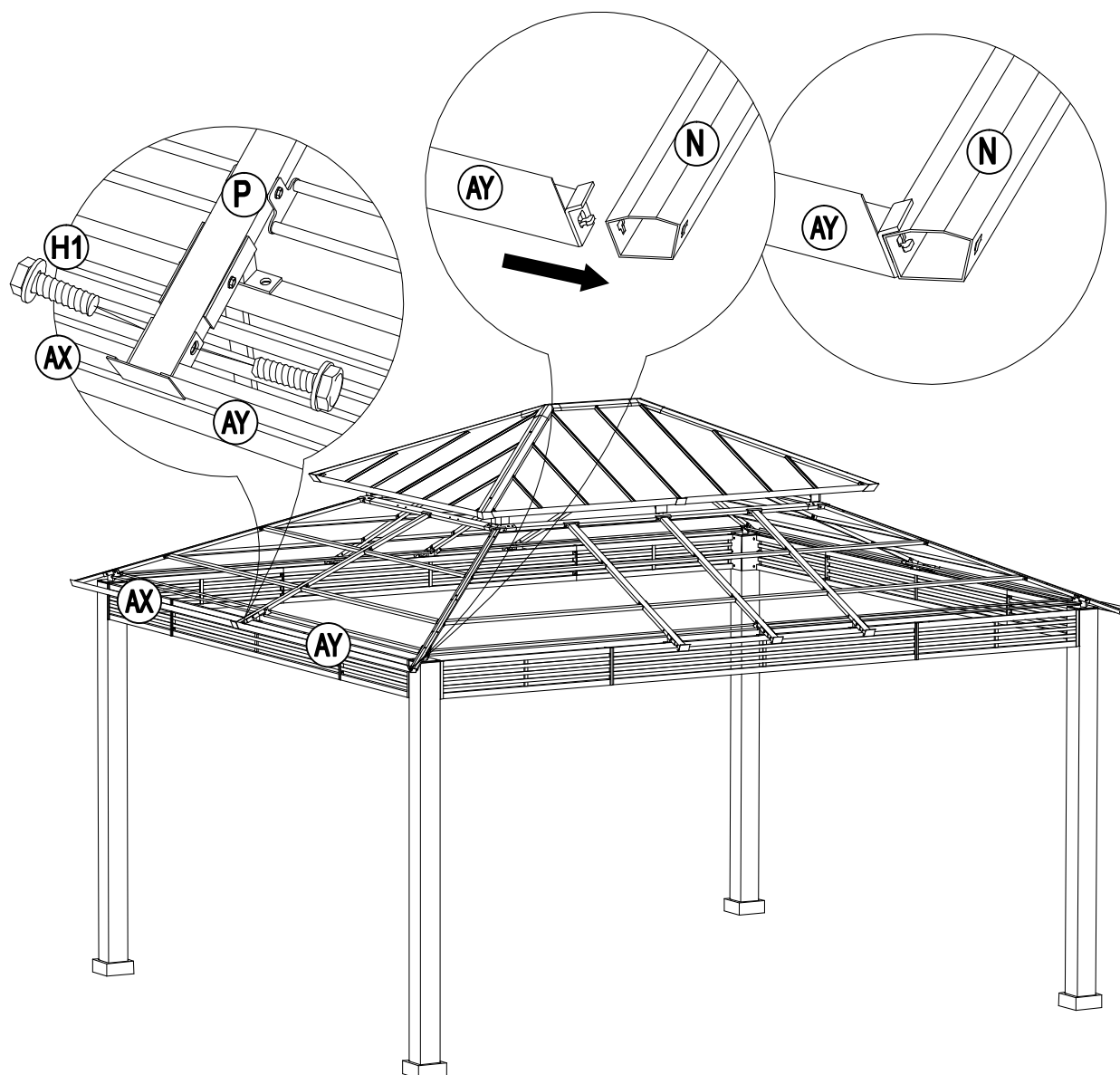
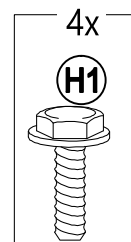
22

Country of Origin: China
Pais d'origine: Chine

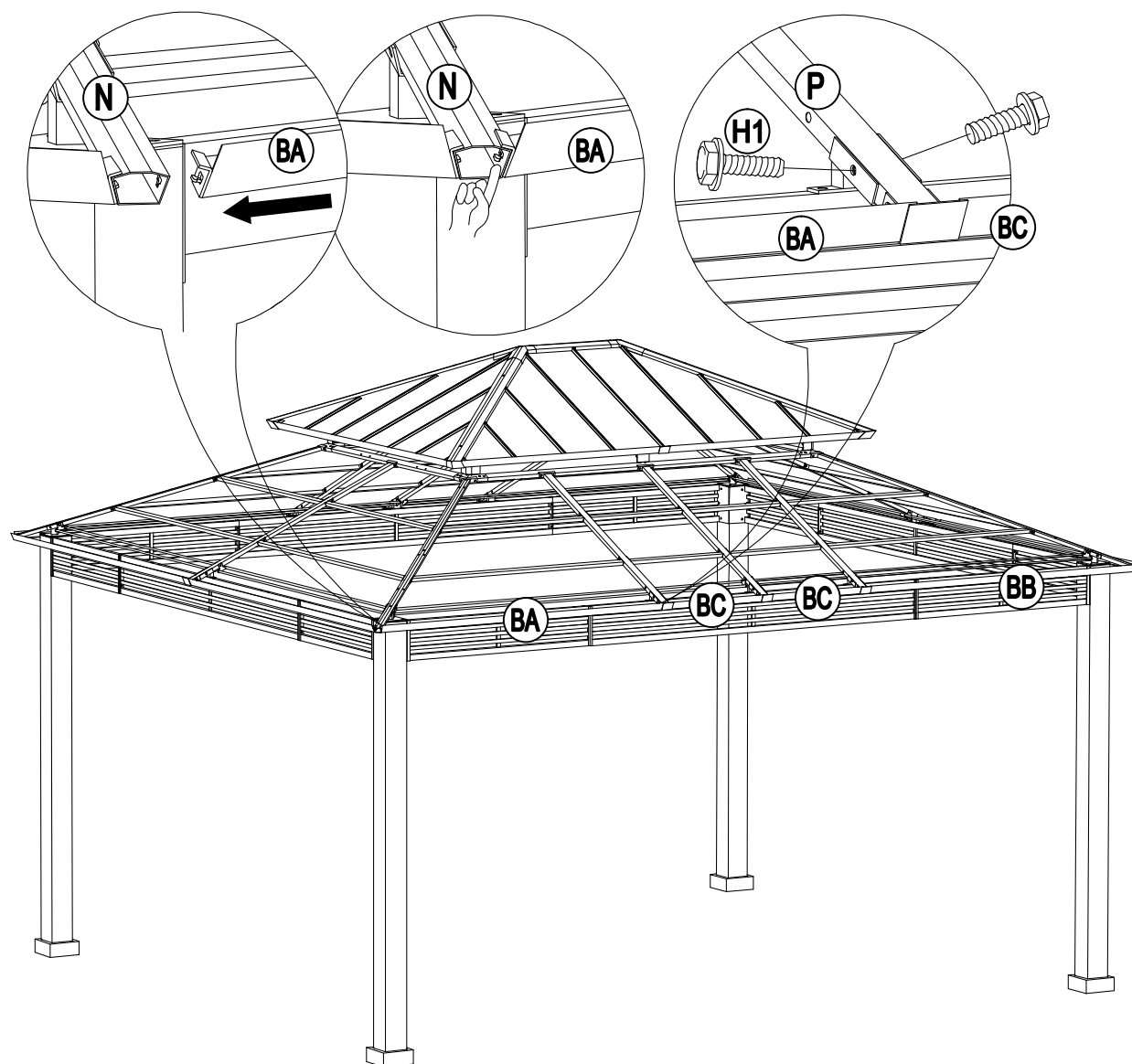
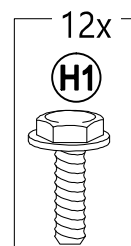
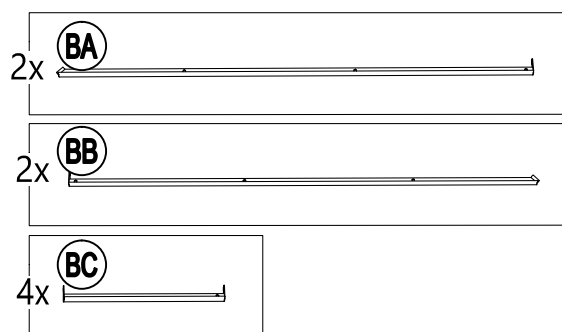
23

Country of Origin: China
Pais d'origine: Chine

24

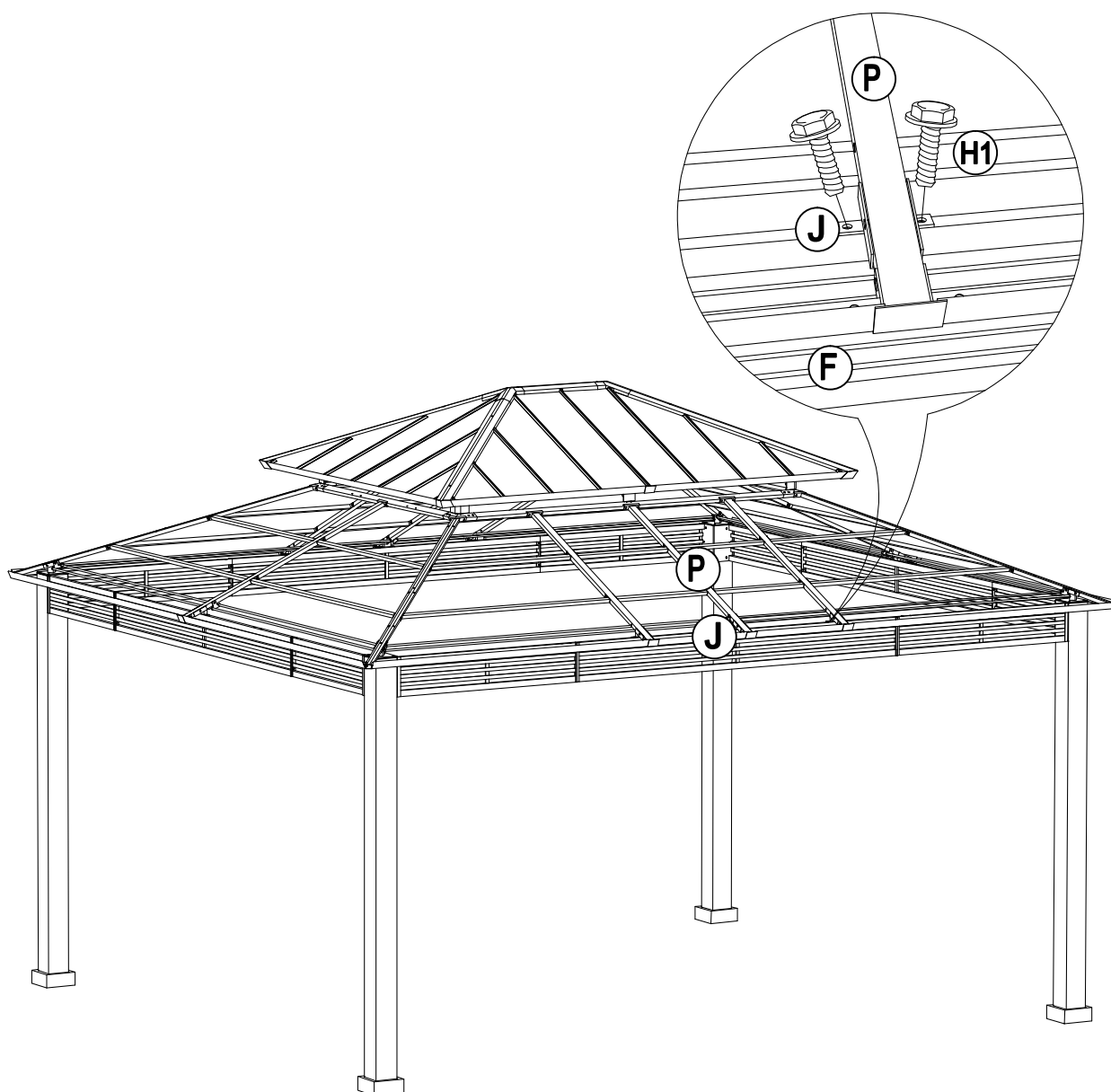
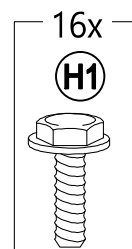

Country of Origin: China
Pais d'origine: Chine

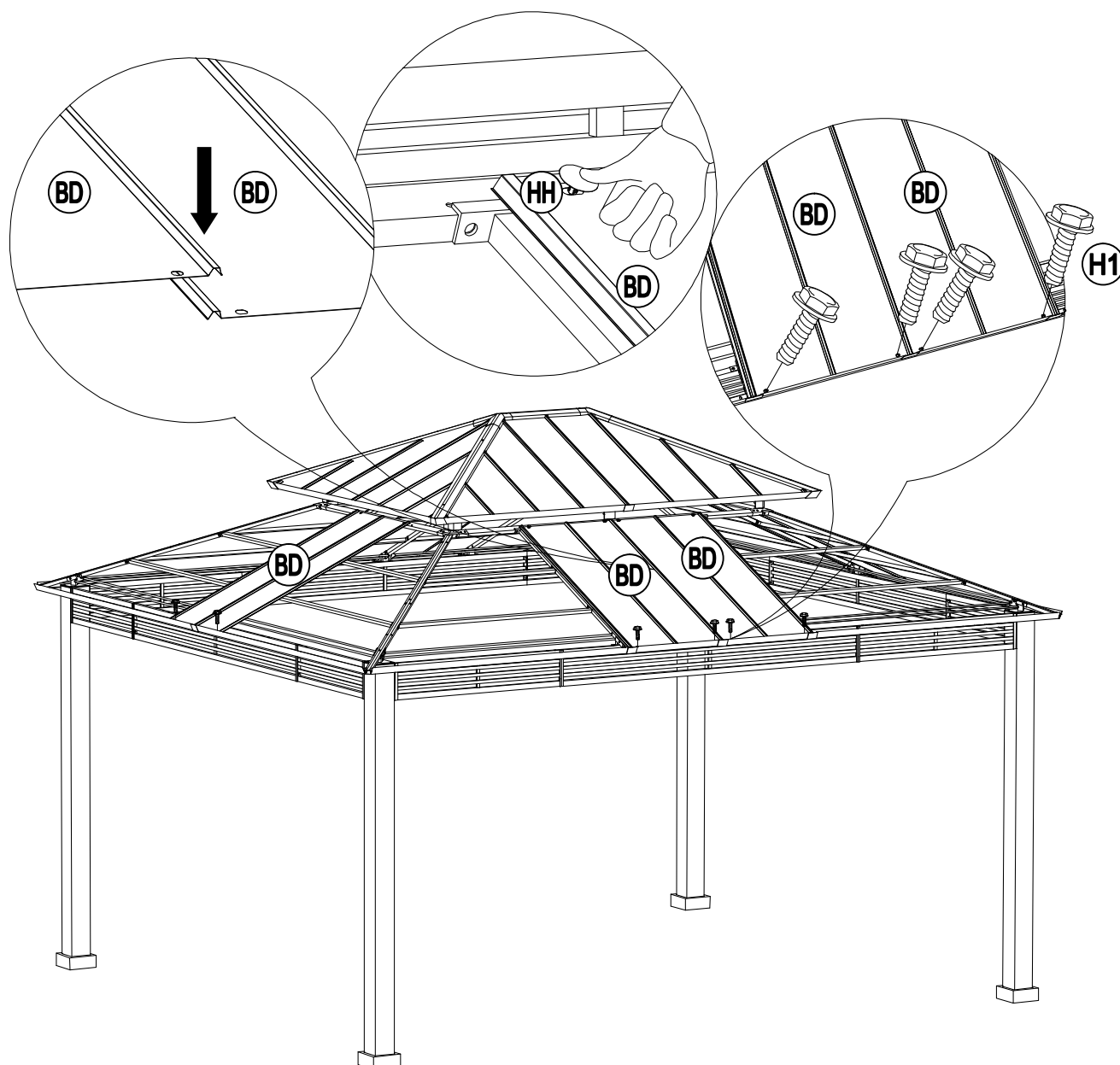
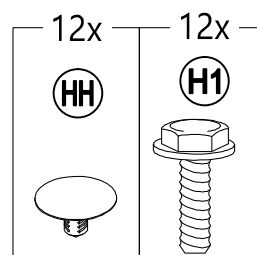
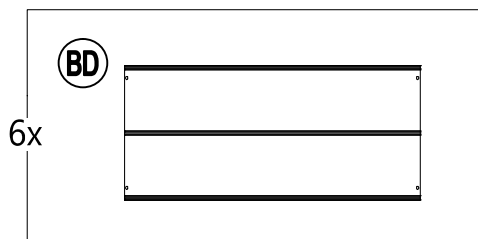
25

Country of Origin: China
Pais d'origine: Chine

26

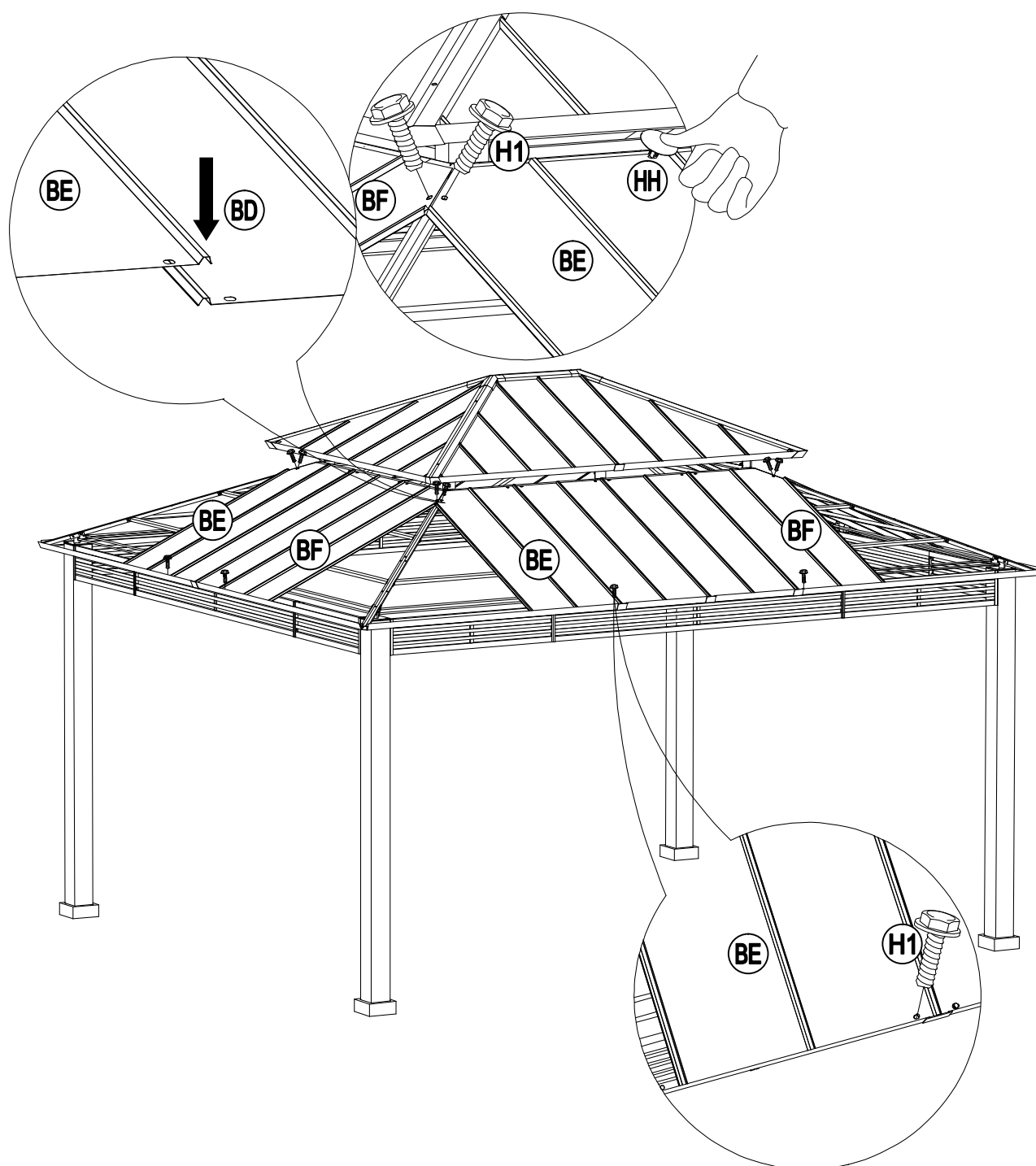
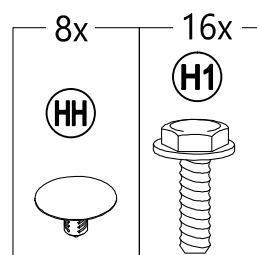
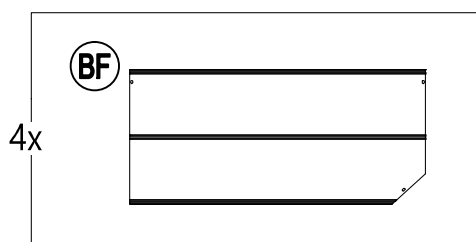
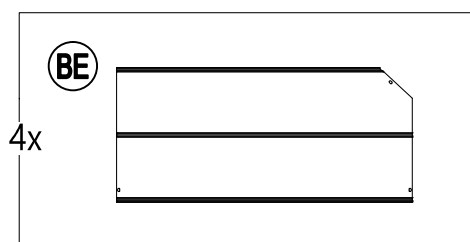

Country of Origin: China
Pais d'origine: Chine

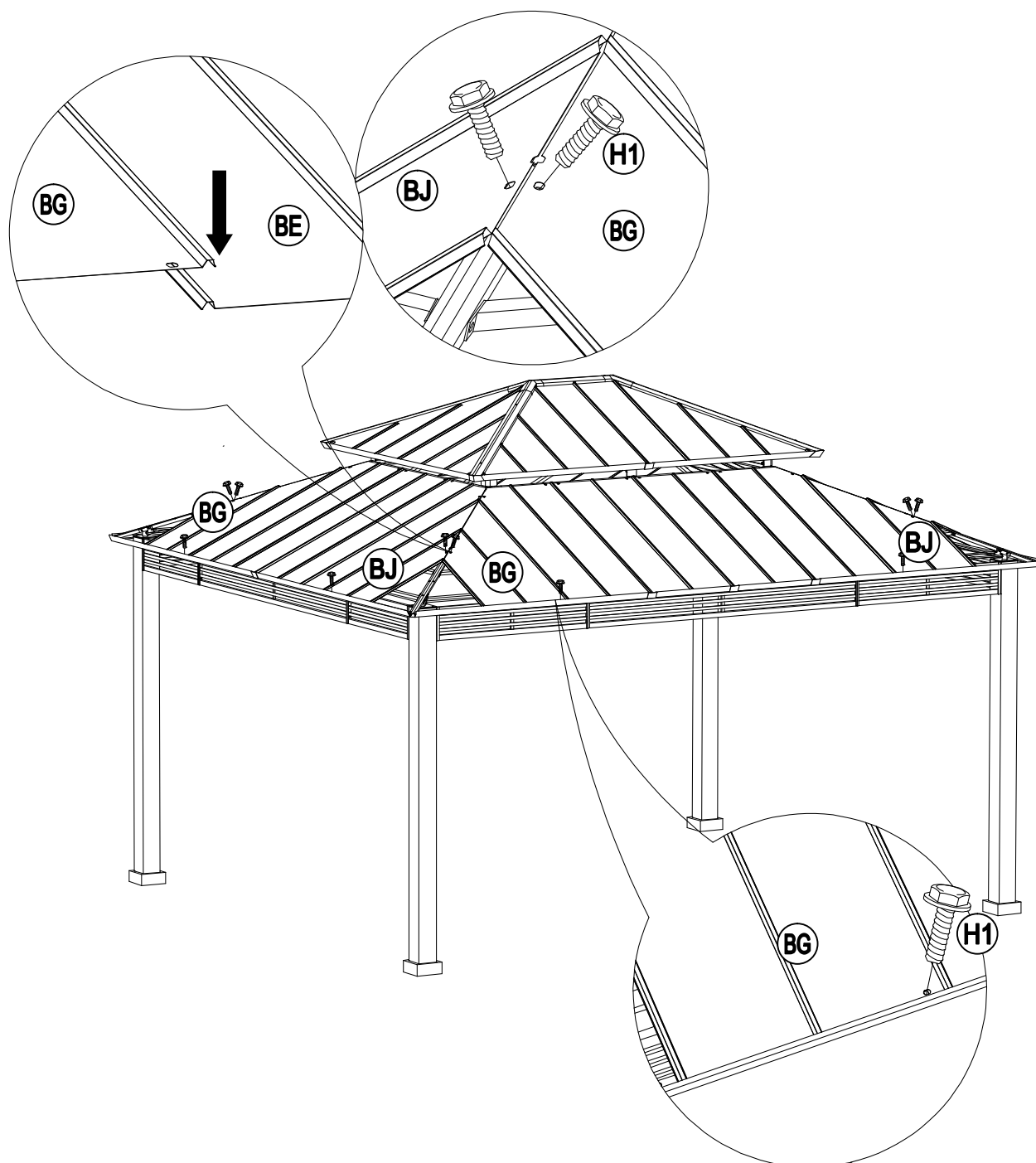
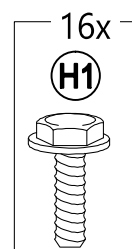
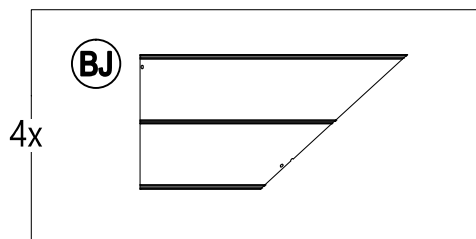
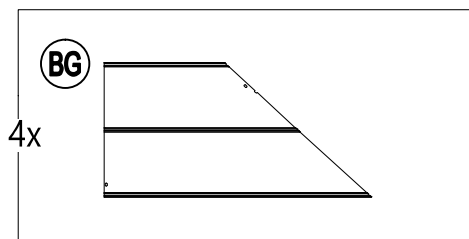
27

Country of Origin: China
Pais d'origine: Chine

28

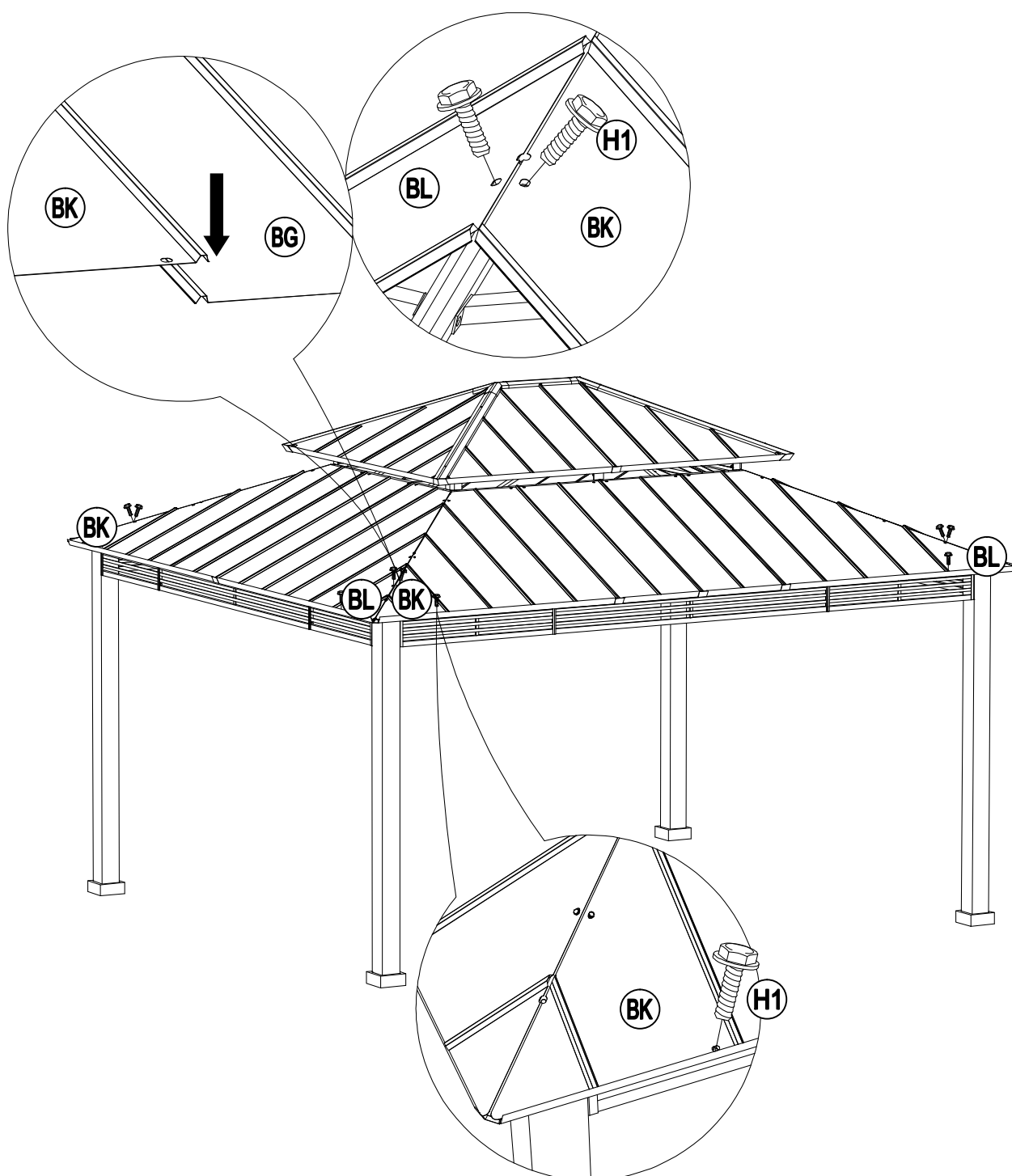
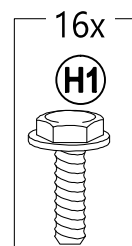
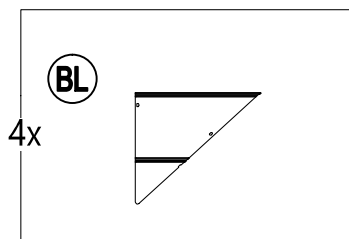
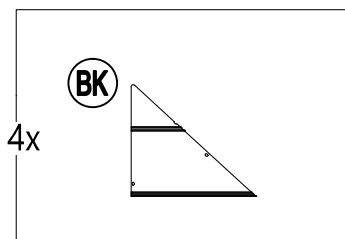

Country of Origin: China
Pais d'origine: Chine

29

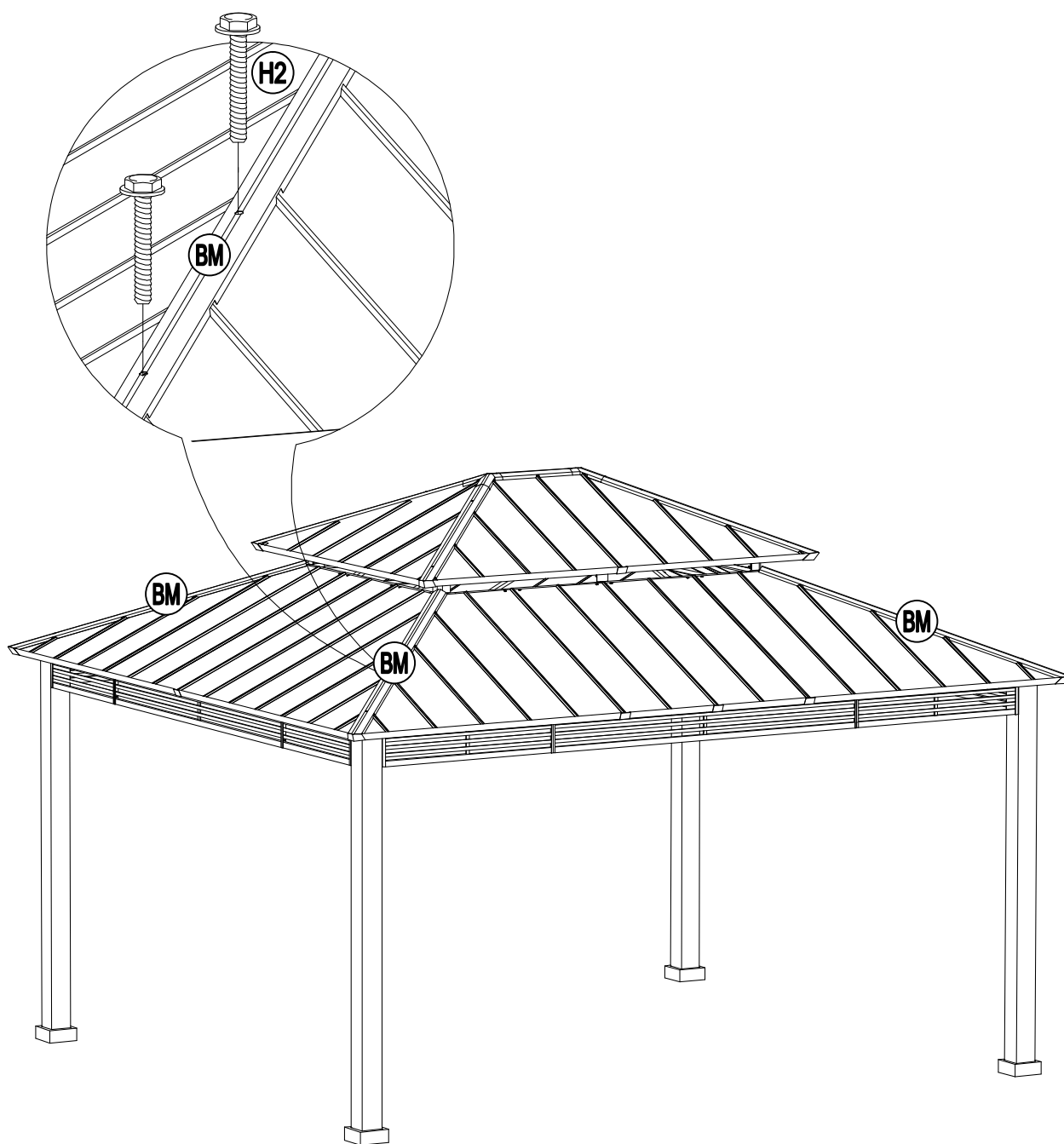
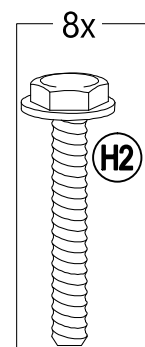
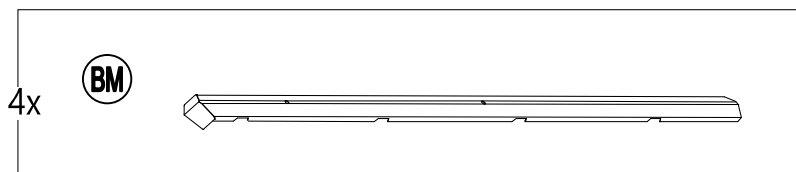

Country of Origin: China
Pais d'origine: Chine

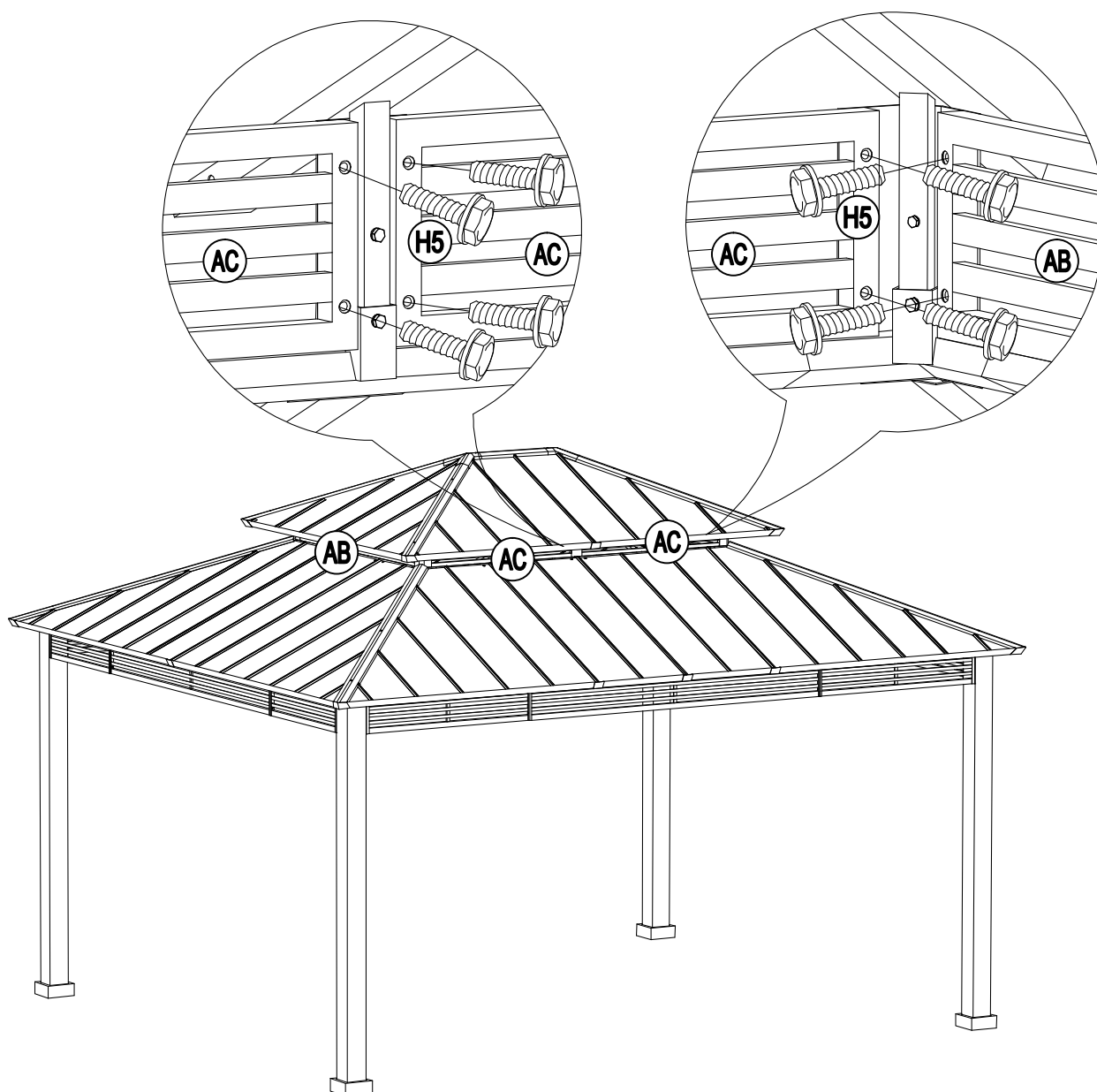
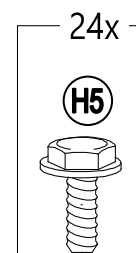
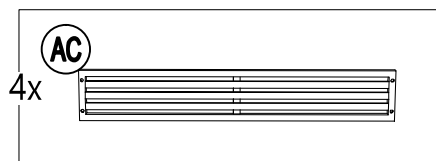
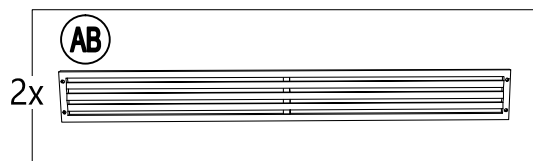
30

Country of Origin: China
Pais d'origine: Chine

31

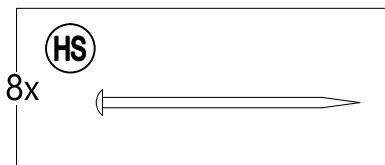

Country of Origin: China
Pais d'origine: Chine

Care and Maintenance

- Our steel components for garden accessories and furniture are treated with rust inhibiting paint that protects it from rusting. However, due to the nature of steel, surface oxidation (rusting) will occur once these protective coatings are scratched. This is not a defect and thus not covered by the warranty.
- To minimize this condition, we recommend care when assembling & handling the product to prevent scratching the paint. Should any scratching or damage occur, we recommend immediate touch-up with rust inhibiting paint.
- Surface rust can also be easily removed with a very light application of common cooking oil. If surface oxidation (rusting) occurs and if no measure is taken to prevent this, the oxidation may start dripping on to deck or patio and caused damaging stains, which may be difficult to remove. This can be prevented if the above-mentioned measures are taken to keep the product from oxidizing.
- Use damp cloth to wipe off the stains as quickly as possible.
- If necessary, wash with a mild solution of soap and water; rinse thoroughly and dry completely.
- Periodically check and ensure that all bolts are well-tighten during use

Limited Manufacturer's Warranty

Sunjoy Group warrants to the original purchaser that this item is free from defects in workmanship and materials for a period of **1 year** from the date of purchase, provided the item was factory-sealed at the time of purchase and is maintained with care and used only for personal, residential purposes. Should any manufacturing defect arise within this warranty period, Sunjoy Group will replace (at our option) any defective merchandise or parts upon proof of purchase; however, transportation and delivery costs, as well as payments to a third party for assembly or disassembly of the item, remain the responsibility of the purchaser. A purchaser of an "open box," previously-returned, or "clearance" item, as well as original purchasers outside of the warranty period, may obtain replacement parts from Sunjoy Group for products in current production, at nominal cost.

Exclusions

Items used for commercial, contract, or other non-residential purposes, or items damaged due to acts of nature, vandalism, misuse, or improper assembly are not covered. Corrosion or rusting of hardware is not covered. Proof of purchase (dated register receipt) is required for warranty claims. Warranty is to the original purchaser and is non-transferable. Any replacement of warranted items will be in the original style and color, or a similar style and color if the original is unavailable or has been discontinued. As some states do not allow exclusions or limitations on an implied warranty, the above exclusions and limitations may not apply. This warranty gives you specific rights, and you may also have other rights, which vary from state to state.

Country of Origin: China
Pais d'origine: Chine

Production Number: XXXXXXXXXX
Numéro de fabrication: XXXXXXXXX

Entretien

- Les composants en acier de nos meubles et accessoires de jardin sont traités avec une peinture antirouille qui les protège. Toutefois, en raison de la nature de l'acier, une oxydation de la surface (rouille) se produira si ces revêtements protecteurs sont égratignés. La garantie ne couvre pas ce phénomène puisqu'il ne s'agit pas d'un défaut.
- Afin de minimiser cette situation, nous recommandons d'être prudent lors de l'assemblage et de la manipulation du produit afin d'éviter d'égratigner la peinture. En cas d'égratignure ou de dommage, nous recommandons d'effectuer immédiatement une retouche avec une peinture antirouille.
- La rouille de surface peut facilement être retirée à l'aide d'une petite quantité d'huile de cuisson. Si une oxydation (rouille) de la surface se produit et qu'aucune mesure n'est prise pour corriger la situation, la rouille pourrait couler sur la terrasse et causer des taches dommageables qui peuvent être difficiles à enlever. Cela peut être évité si les mesures mentionnées ci-dessus sont prises pour empêcher l'oxydation du produit.
- Utilisez un linge humide pour essuyer les taches le plus rapidement possible.
- Au besoin, nettoyez le produit avec une solution d'eau et de savon doux, rincez-le abondamment et séchez-le complètement.
- Vérifiez périodiquement pour vous assurer que tous les écrous sont bien serrés pendant l'utilisation.

Garantie limitée du fabricant

Sunjoy Group garantit à l'acheteur initial que ce produit ne présentera aucun défaut de fabrication et de matériaux pendant une période de un an à compter de la date de l'achat si le produit a été acheté dans son emballage scellé à l'usine, et s'il a été entretenu correctement et utilisé à des fins personnelles et résidentielles seulement. Si le produit présente un défaut de fabrication pendant cette période de garantie, Sunjoy Group remplacera (à sa discrétion) toute marchandise ou pièce défectueuse sur présentation d'une preuve d'achat. Toutefois, les frais de transport et de manutention, ainsi que les paiements versés à un tiers pour l'assemblage ou le démontage du produit, demeurent la responsabilité de l'acheteur. Les acheteurs de produits avec « boîte ouverte », précédemment retournés ou « en liquidation », ainsi que les acheteurs initiaux de produits dont la période de garantie est terminée, peuvent obtenir des pièces de rechange auprès de Sunjoy Group pour des produits actuellement en production, à peu de frais.

Exclusions:

les articles utilisés à des fins commerciales, locatives ou non résidentielles et les articles endommagés par des phénomènes naturels, des actes de vandalisme, un usage inapproprié ou un assemblage inadéquat ne sont pas couverts. La corrosion et la rouille de la quincaillerie ne sont pas couvertes. Une preuve d'achat (une copie de votre reçu daté) doit être présentée avec toute réclamation au titre de la garantie. La garantie n'est accordée qu'à l'acheteur initial et est non transférable. Si l'article original n'est plus offert, il sera remplacé par un article d'une couleur et d'un style similaires. Certains États ou certaines provinces ne permettent pas l'exclusion ou la limitation d'une garantie implicite, de sorte que les limitations et exclusions mentionnées ci-dessus peuvent ne pas s'appliquer à vous. Cette garantie vous confère des droits précis. Il est possible que vous disposiez également d'autres droits, qui varient d'un État ou d'une province à l'autre.

Country of Origin: China
Pais d'origine: Chine

Production Number: XXXXXXXXXX
Numéro de fabrication: XXXXXXXXX