

13x15 Hard Top Gazebo / Gazebo Extérieur Finition Cuivr

Item/Article #: A102007633

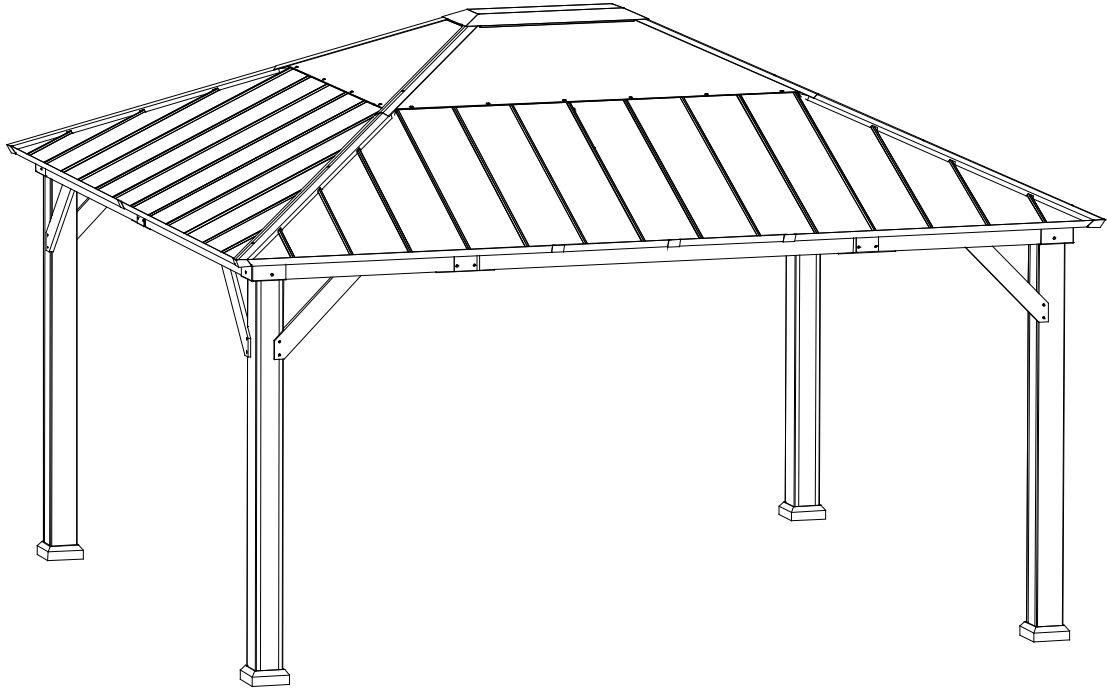

***Questions? Issues? Missing Part? Professional
Installation Service?***

Contact us at customer.care@sunjoygroup.com

***Questions? Problèmes? Pièce manquante? Service
d'installation professionnel? Contactez-nous à
client.care@sunjoygroup.com***



A10200763323



Country of Origin: China
Pais d'origine: Chine

Production Number: 2023100965
Numéro de fabrication: 2023100965

Important Safety Instructions



Warning! To reduce the risk of serious injury, read the following safety instructions before assembling and using the gazebo.

Please check with your local governing authority/local municipal codes regarding installation of structures before assembly.

Caution! Proper placement of your gazebo is essential.

Do not place the product underneath electrical lines.

Keep children away during assembly.

This product contains small parts which can be swallowed by children.

Keep fingers away from the places where they can be pinched or trapped.

Do not attempt to assemble the gazebo if any parts are missing.

- This product is intended for domestic outdoor use only.
- The product should be placed on flat, horizontal ground.
- Ensure enough clearance around the product. Before assembling the product, find level ground not less than 6' (1.8 m) away from any structures or obstructions, such as fences, garages, houses, overhanging branches, laundry lines, or electrical wires.
- This gazebo is not to be regarded as part of a building/house structure. The gazebo is to be anchored onto the ground for added safety. Do not assemble the gazebo onto soil/earth ground. It is best advisable to have the gazebo built onto a wooden deck or concrete ground for stability. If it is to be build onto a wooden deck/ground, do ensure that the wooden deck/ground has a strong foundation. It is advisable to use appropriate floor plugs (not provided) to anchor the gazebo onto the wooden/concrete ground.
- Some structures may require two or more people to install safely. Check for underground utilities before digging or driving stakes into the ground.
- During installation, follow all safety warnings provided with your tools, and use safety glasses.
- In case you set up more than one gazebo, keep a minimum distance of 10' (3 m) between the gazebos.
- Any assembly or maintenance of the product must be carried out by adults only.
- Arrange necessary manpower when assembling or moving the product.
- Some parts may contain sharp edges. Wear protective gloves if necessary.
- Keep children and pets away while setting up the gazebo.
- Check all nuts and bolts periodically to ensure bolts/nuts are tightened.
- Repairing and replacing parts should be done by a qualified technician.
- This gazebo is intended for decorative and sunshade purposes only, and it is not designed to withstand harsh weather, including high winds, rain, and snow.
- Do not light any fires inside or near the product !
- Stay calm if fire breaks out. Search for the nearest exit. Do not return to the gazebo before firemen allow you to do so.
- Do not hang heavy weights on the roof frame.
- Do not climb onto the roof of the gazebo. Falling off the gazebo can result in serious injury.
- Retain the original packaging to store the gazebo

Consignes de sécurité importantes



Avertissement! Veuillez lire les consignes de sécurité suivantes avant d'assembler et d'utiliser l'abri de jardin afin de réduire le risque de blessures graves.

Veuillez vous renseigner auprès des autorités locales concernant les codes municipaux à l'égard de l'installation des structures avant d'effectuer tout montage

ATTENTION! L'emplacement approprié de l'abri de jardin est essentiel.

Ne placez pas le produit en dessous de fils électriques.

Tenez les enfants à l'écart du produit pendant son assemblage.

Ce produit contient des petites pièces que les enfants peuvent avaler.

Tenez vos doigts éloignés des endroits où ils risquent d'être pincés ou blessés.

Ne tentez pas d'assembler l'abri de jardin s'il vous manque des pièces.

- Ce produit est uniquement destiné à un usage domestique et doit être utilisé à l'extérieur.
- L'abri de jardin doit être placé sur une surface plane et horizontale.
- Prévoyez un espace dégagé suffisant autour du produit. Avant de procéder à l'assemblage du produit, choisissez une surface au sol plane et éloignée d'au moins 6 pi (1,8 m) des structures ou obstructions environnantes, comme les clôtures, garages, maisons, branches surplombantes, cordes à linge ou fils électriques.
- Ce gazébo ne doit pas être considéré comme faisant partie d'une structure de bâtiment ou maison. Le gazébo doit être ancré à la terre pour plus de sécurité. Ne construisez pas le gazébo sur la terre ou le sol. Il est préférable de construire le gazébo sur une terrasse en bois ou ciment ou béton pour la stabilité. Si le gazébo doit être construit sur une terrasse en bois ou la terre, assurez-vous que la terrasse ou la terre a une base solide. Il est recommandé d'utiliser les boulons d'ancrage (pas compris) convenables pour ancrer le gazébo sur la surface en bois ou en ciment.
- Certaines structures peuvent nécessiter deux personnes ou plus pour l'installer en toute sécurité. Vérifiez les services publics souterrains avant de creuser ou d'enfoncer des piquets dans le sol.
- Lors de l'installation, suivez toutes les consignes de sécurité fournies avec vos outils et portez des lunettes de sécurité.
- Si vous installez plus d'un abri de jardin, gardez une distance minimale de 10 pi (3 m) entre les abris de jardin.
- L'assemblage et l'entretien de ce produit ne doivent être effectués que par des adultes.
- Au besoin, demandez à d'autres personnes de vous aider à assembler ou déplacer le produit.
- Certaines pièces peuvent contenir des bords tranchants. Portez des gants de protection si nécessaire.
- Tenez les enfants et les animaux à l'écart de l'abri de jardin pendant son assemblage.
- Assurez-vous périodiquement que tous les écrous et boulons pour s'assurer que les boulons /écrous sont serrés.
- La réparation et le remplacement des pièces doivent être effectués par un technicien qualifié.
- Cet abri de jardin est conçu uniquement pour des fins décoratives et de pare-soleil, et il n'est pas conçu pour résister aux intempéries, notamment les vents violents, la pluie et la neige.
- N'allumez pas un feu à l'intérieur ou près du produit!
- Si un incendie se déclare, restez calme. Cherchez la sortie la plus proche. Ne retournez pas à l'abri de jardin avant que.
- les pompiers ne vous le permettent.
- Ne suspendez aucun poids lourd sur le cadre du toit. Ne montez pas sur le toit de l'abri de jardin. Tomber de l'abri de jardin peut entraîner des blessures graves.
- Conservez l'emballage original aux fins de remisage de l'abri de jardin.

IMPORTANT:

- Please read and understand this manual before any assembly. Before beginning assembly of product, make sure all parts are present. Compare parts with packaging contents list.
- When assembling wooden parts, do not overtorque the bolts to avoid splitting the wood. See image illustration.
- Place all parts from the box in a cleared area and position them on the floor in front of you.
- Remove all packing materials and place them back into the box. Do not dispose of the packing materials until assembly is complete.
- Read each step carefully before beginning any assembly and make sure you understand each step. If you are missing a part, please email customer.care@sunjoygroup.com.
- Needed for assembly: (The following tools are not included)

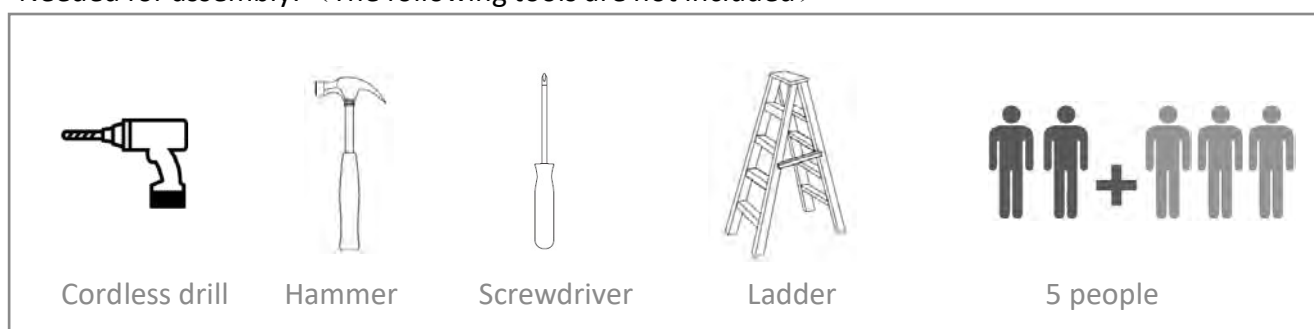

This identifies information that requires special attention. Improper assembly could lead to an unsafe or dangerous condition.

**Use Level**

Check that set or assembly is properly level before proceeding.

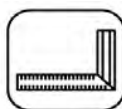
**Square Assembly**

Check that assembly is square before tightening bolts.

**Tighten Bolts**

Do not overtorque mounting bolts. Over-tightening may cause the wood to crack creating splinters and other structural damage.

**Measure Distance**

IMPORTANT:

- Veuillez lire et bien comprendre ce guide avant de procéder à l'assemblage. Avant de procéder à l'assemblage du produit, assurez-vous que toutes les pièces sont présentes.
- Lors de l'assemblage de pièces en bois, ne serrez pas trop les boulons afin d'éviter de fendre le bois.
- Consultez l'illustration dans les schémas. Mettez toutes les pièces de la boîte dans une zone dégagée et positionnez-les sur le sol devant vous.
- Retirez tous les matériels d'emballage et remettez-les dans la boîte. Ne les jetez pas avant d'avoir terminé l'assemblage.
- Lisez chaque étape attentivement avant de commencer à assembler et assurez-vous de comprendre bien chaque étape. S'il vous manque des pièces, veuillez envoyer un email à customer.care@sunjoygroup.com.
- Nécessaire pour l'assemblage : (les outils suivants ne sont pas inclus).

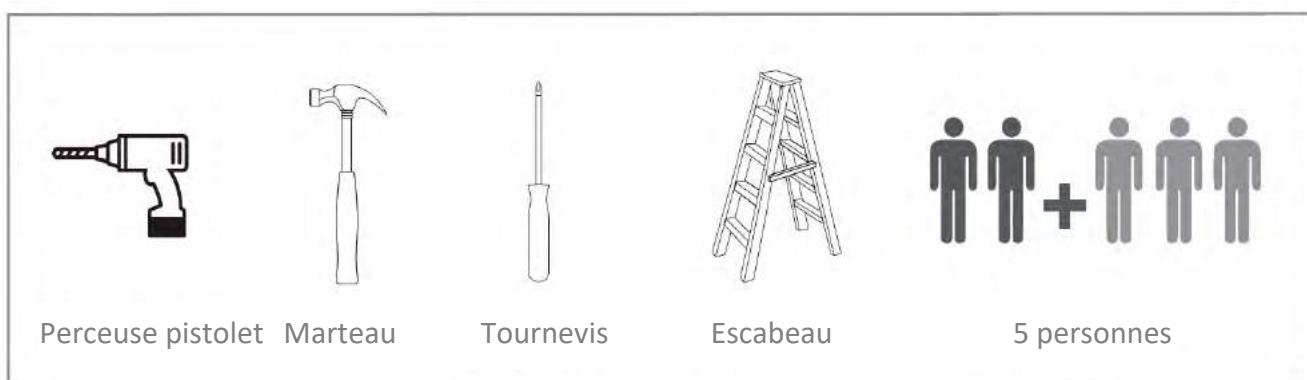

Cette icône identifie de l'information
Utilisez un niveau Vérifiez avec un
équerre Serrez les boulons Mesurer
la distance

**Utilisez un niveau**

Vérifiez que l'assemblage est d'aplomb
avant de procéder à la prochaine étape.

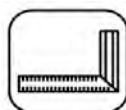
**Vérifiez avec un équerre**

Vérifiez que l'assemblage est carré avant
de serrez les boulons.

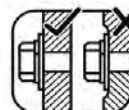
**Serrer les boulons**

Ne serrez pas trop les boulons de fixation. Un
serrage excessif peut provoquer des fissures
dans le bois, créant des éclats de bois et d'autres
dommages structurels

**Mesurer la distance**

Installation blueprint/
Plan d'installation

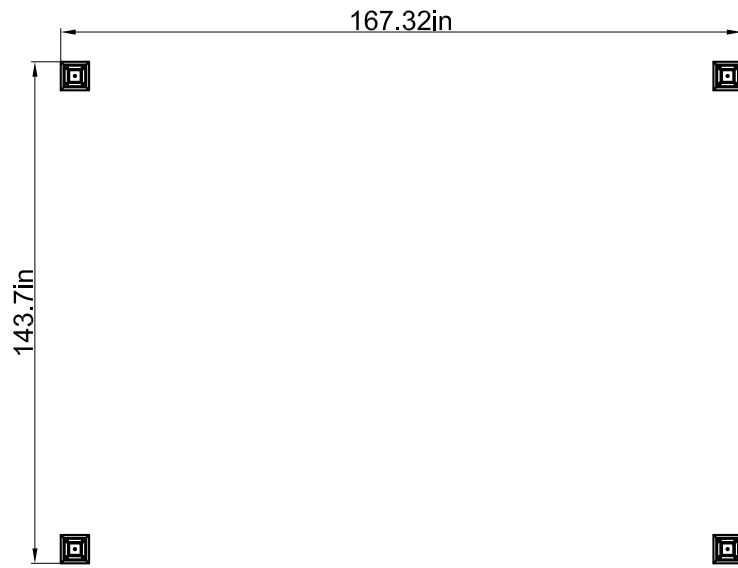



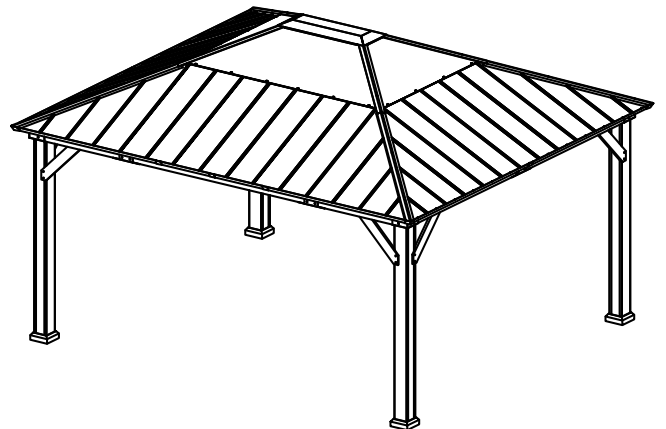
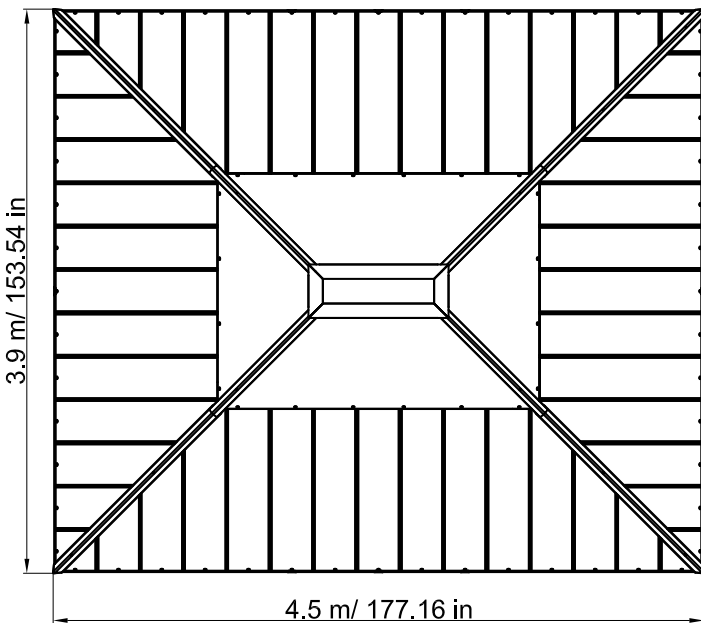
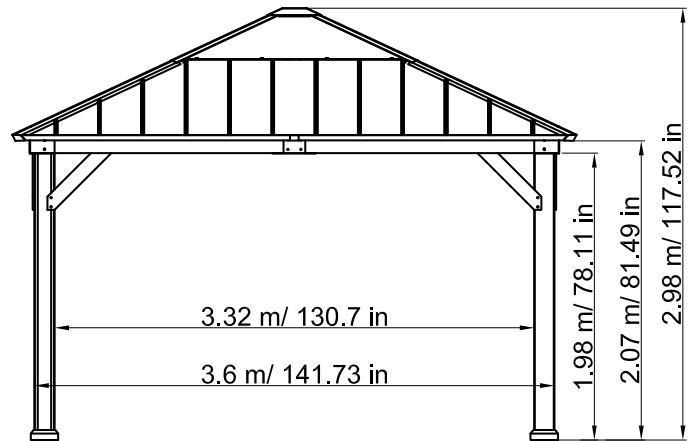
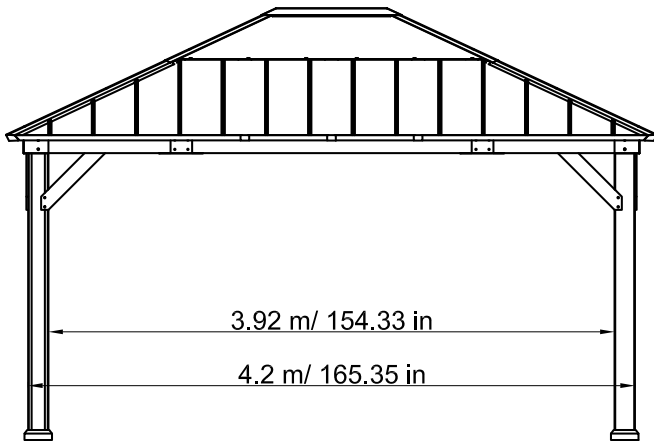



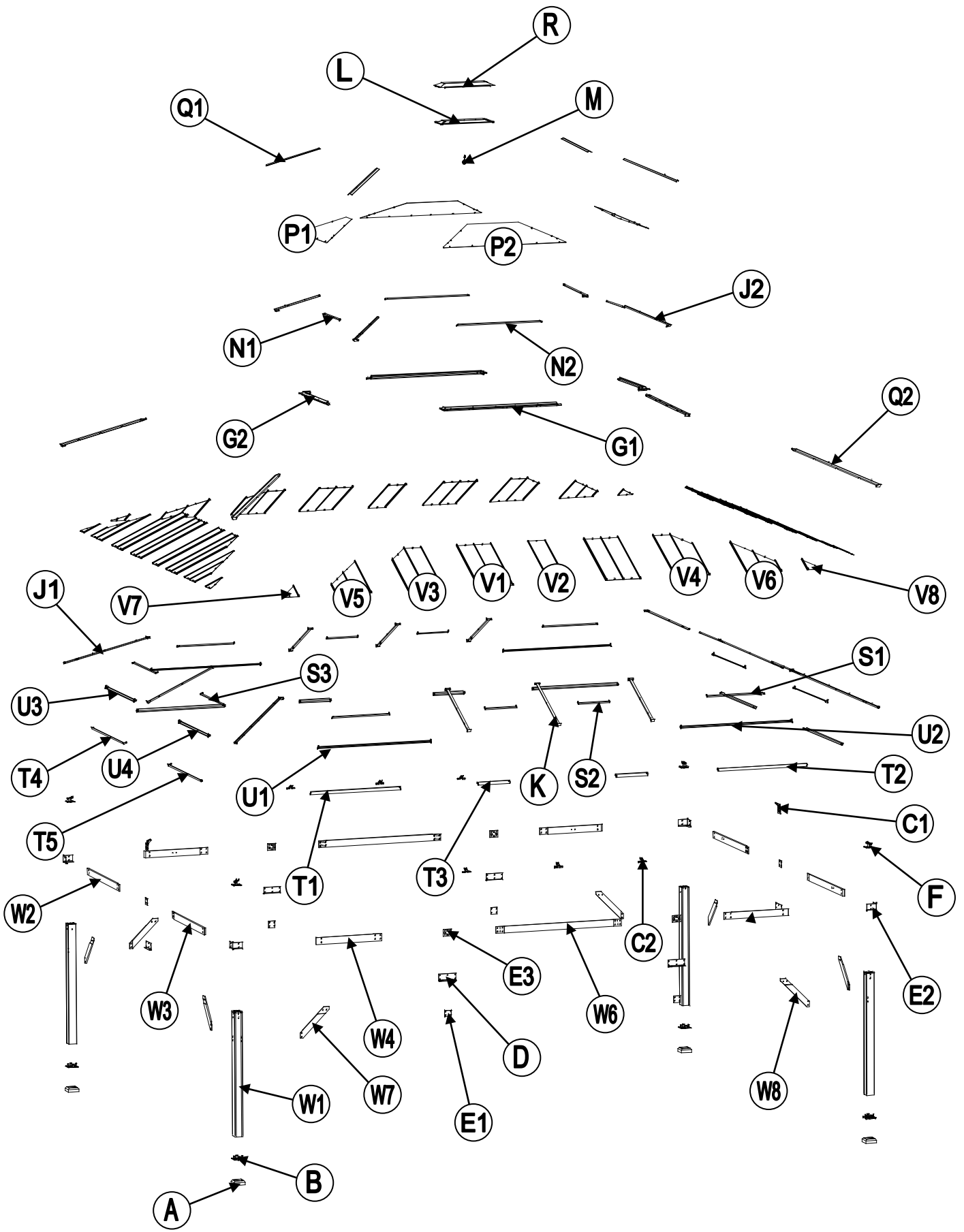







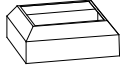
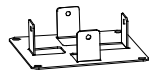

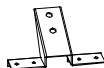
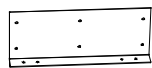



Product size effect
drawing/Dessin d'effet
de taille de produit

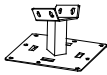





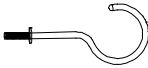

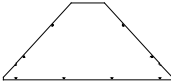













EXPLODED DRAWING/DESSIN ÉCLATÉ





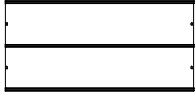

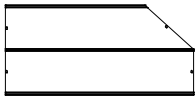
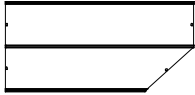
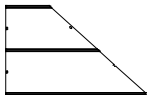
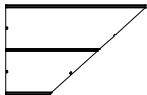



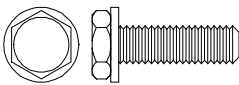
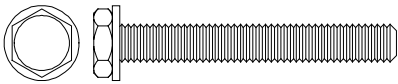
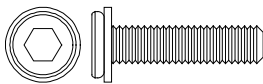

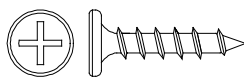
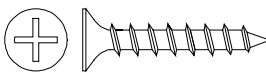
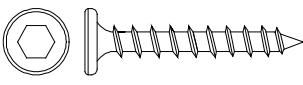
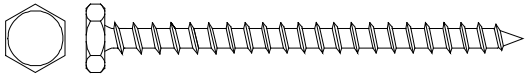
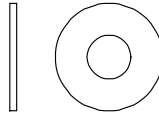
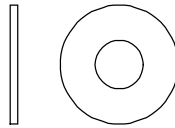
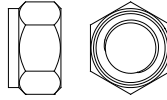
Parts List/Liste de Pièces				
Label/ Étiquette	Part Number / Numéro de la Pièce	Description	Qty/ Quantité	Part Image/Numéro de la Pièce Diagramme
W1	P00020022701	Post/ Poteau	4	
W2	P00040159401	Lateral Left Long Cross Beam / Traverse Longue Latérale Gauche	2	
W3	P00040159501	Lateral Right Long Cross Beam/ Traverse Longue Latérale Droite	2	
W4	P00040159701	Left Cross Beam (Long Side)/ Traverse Gauche(Côté Long)	4	
W6	P00040159601	Middle Cross Beam (Long Side)/ Traverse Centrale (Côté Long)	2	
W7	P00500020001	Brace 1/Barre de Renfort 1	4	
W8	P00500020101	Brace 2/Barre de Renfort 2	4	
A	P00610027202	Base Cover/Barde de la base	4	
B	P00010051203	Post Base/Base du Poteau	4	
C1	P00050189702	Middle Beam Connector/ Connexion de la poutre centrale	2	
C2	P00050189501	Middle Beam Connector 2/ Connexion de la poutre centrale 2	6	
D	P00220042602	Cross Beam Cap/ Capuchon De la Traverse	6	

E1	P00560027201	Decoration/ Ornement	6	
E2	P00560055201	Corner Beam Cap/ Couvert de la Poutre du Coin	4	
E3	P00220043602	Cross Beam Inner Middle Baffle/ Déflecteur Central Intérieur de la Traverse	4	
F	P00050190102	Rafter Connector/ Connexion du Chevron	4	
G1	P00050189301	Big Roof Long Frame /Structure Longue du Grand Toit	2	
G2	P00050189201	Big Roof Short Frame/Structure Courte du Grand Toit	2	
J1	P00060253904	Big Roof Rafter/ Chevron du Grand Toit	4	
J2	P00060251501	Small Roof Rafter/ Plafond du Petit Toit	4	
K	P00060254103	Big Roof Middle Beam /Poutre Centrale du Grand Toit	8	
L	P00050188301	Small Roof Connector / Connexion du petit toit	1	
M	P00580015401	Hook/Crochet	1	
N1	P00060252401	Small Roof Short Small Beam/ Petit toit court petit faisceau	2	
N2	P00060252501	Small Roof Long Small Beam / Petit toit long petit faisceau	2	
P1	P00070121801	Small Roof Short Panel /Panneau court du petit toit	2	

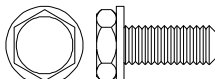
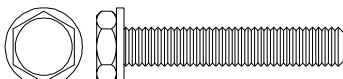
P2	P00070121901	Small Roof Long Panel/Panneau long du petit toit	2	
Q1	P00080043701	Small Roof Rafter Cap/ Capuchon du Chevron du Petit Toit	4	
Q2	P00080044101	Big Roof Rafter Cap/ Chevron du Grand Toit	4	
R	P00090019701	Small Top Cap/ Capuchon du Petit Toit	1	
S1	P00060254601	Long Small Beam (Long Side) /Poutre Petite Longue (Côté Long)	4	
S2	P00060254901	Short Small Beam (Long Side) /Poutre Petite Courte(Côté Long)	4	
S3	P00060254701	Small Beam (Short Side)/Petite Poutre (Côté Court)	4	
T1	P00060255604	Short Left Panel Flashing/Bande d'Étanchéité du Panneau Court Gauche	2	
T2	P00060255704	Short Right Panel Flashing/Bande d'Étanchéité du Panneau Court Droit	2	
T3	P00060256201	Big Roof Middle Panel Flashing (Long Side)/Solin du Panneau Central du Grand Toit (Côté Long)	4	
T4	P00060255803	Long Left Panel Flashing /Panneau d'Étanchéité Long Gauche	2	
T5	P00060255903	Long Right Panel Flashing/Panneau d'Étanchéité Long Droit	2	

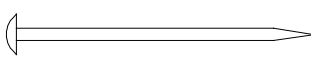
U1	P00570055801	Mosquito Netting 1/Filet moustiquaire 1	2	
U2	P00570055901	Mosquito Netting 2/Filet moustiquaire 2	2	
U3	P00570055603	Mosquito Netting 3 /Filet moustiquaire 3	2	
U4	P00570055703	Mosquito Netting 4/Filet moustiquaire 4	2	
V1	P00070122602	Big Roof Middle Panel /Panneau Central du Grand Toit	6	
V2	P00070122702	Big Roof Middle Small Panel /Petit Panneau Central du Grand Toit	4	
V3	P00070122403	Big Roof Left Big Panel /Grand Panneau Gauche du Grand Toit	4	
V4	P00070122503	Big Roof Right Big Panel /Grand Panneau Droit du Grand Toit	4	
V5	P00070122204	Big Roof Left Middle Panel/ Panneau Central Gauche du Grand Toit	4	
V6	P00070122304	Big Roof Right Middle Panel / Panneau Central Droit du Grand Toit	4	
V7	P00070122004	Big Roof Left Small Panel / Grand toit gauche petit panneau	4	
V8	P00070122104	Big Roof Right Small Panel/ Petit panneau droit du grand toit	4	

Hardware Pack/Pack Quincaillerie					
Label/ Étiquette	Part Number / Numéro de la Pièce	Description	Qty / Quantité	Add	Part Image/Numéro de la PièceDiagramme
H1	H100010047	Bolt M6*20/ Boulon M6*20	202	11	
H2	H100010059	Bolt M6*45/ Boulon M6*45	8	1	
H3	H100040020	Bolt M8*30/ Boulon M8*30	24	2	
H5	H100010165	Bolt M10*185/ Boulon M10*185	8	1	
H6	H030080005	Screw ST4.8*25/Vis ST4.8*25	60	3	
H7	H030050058	ScrewST4.8*30 /Vis ST4.8*30	72	4	
H8	H030030013	Screw ST8*35/Vis ST8*35	32	2	
H9	H030010031	Screw ST9.5*80/Vis ST9.5*80	8	1	
H10	H050080007	Flat washer M8/Rondelle Plate M8	32	2	
H11	H050080008	Flat washer M10/Rondelle Plate M10	16	1	
H12	H040050026	Nut M10/ Écrou M10	8	1	
H13	H040090004	T-Nut M8*8/ T-Nut M8*8	24	2	
H14	H090990002	M3 Dril/ M3 Percer	2	0	

H15	H100010068	Bolt M6*15/ Boulon M6*15	36	2	
H16	H100010069	Bolt M6*35/ Boulon M6*35	4	1	
HH	H050050018	M6 Rubber Washer/Rondelle en Caoutchouc M6	12	1	
HS	H070010003	Stake $\Phi 8*180$ / Piquet $\Phi 8*180$	8	0	
HW1	H090010017	Wrench M6/ Clé M6	2	0	
HW2	H090030005	Allen Wrench M8 /Clé Allen M8	1	0	
HW3	H090010015	Wrench M10/ Clé M10	2	0	

1

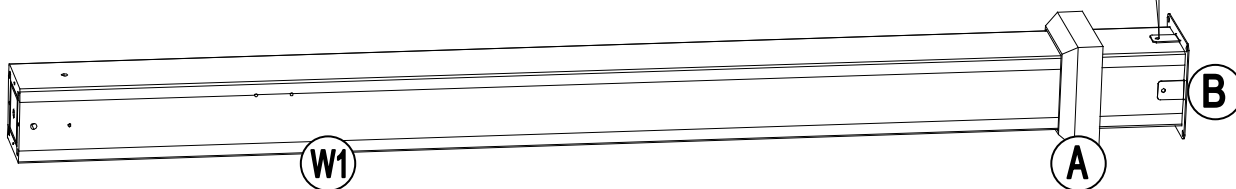
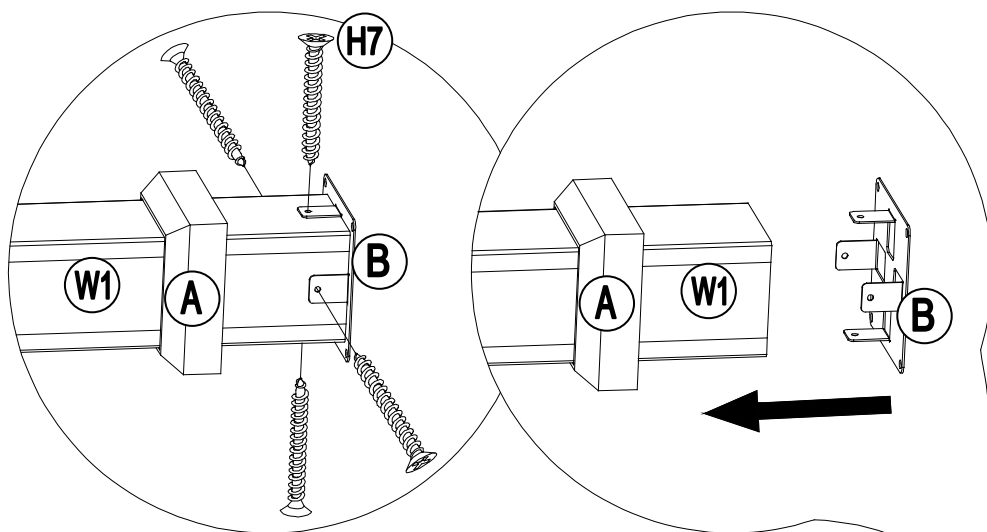
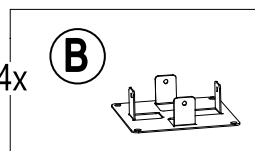
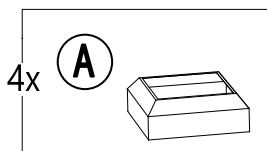
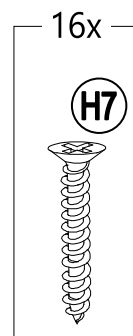
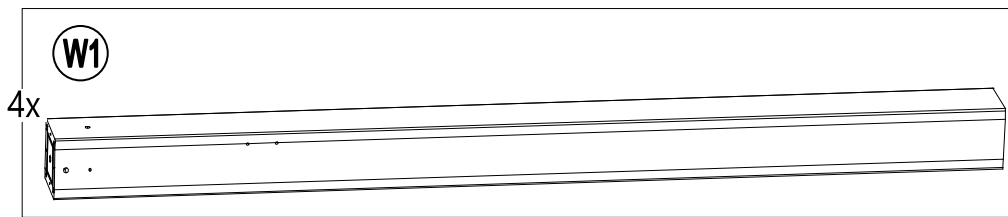

2

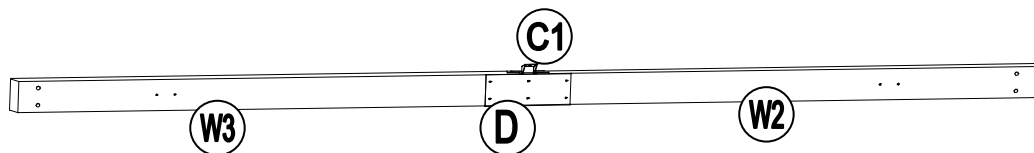
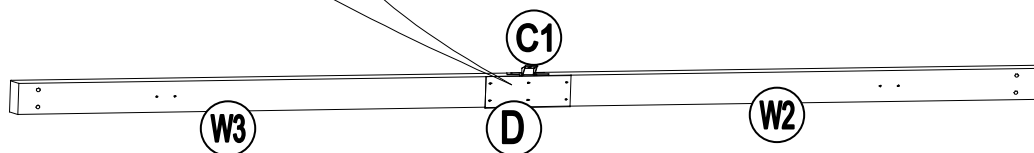
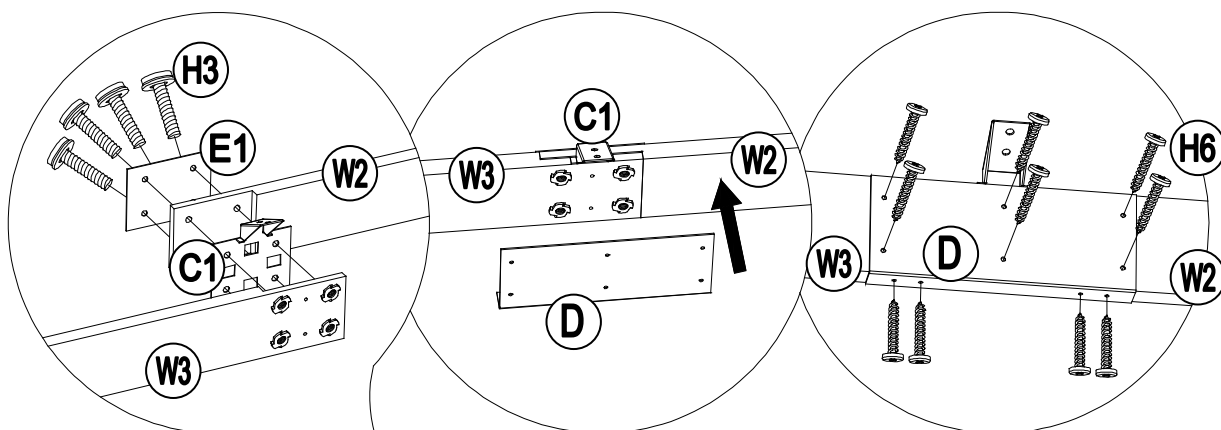
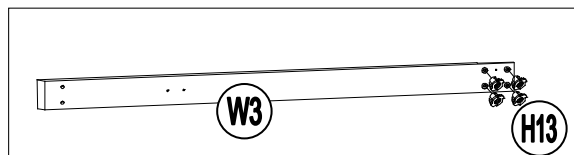
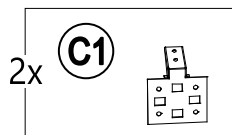
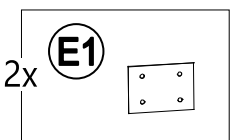
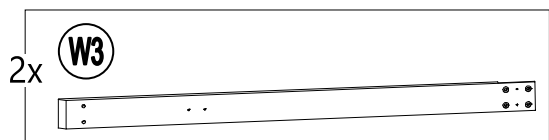
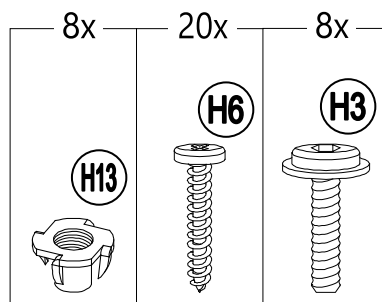
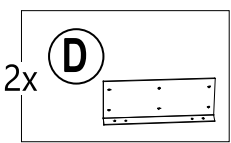
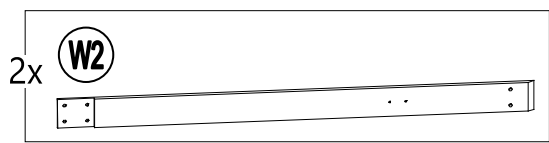

3

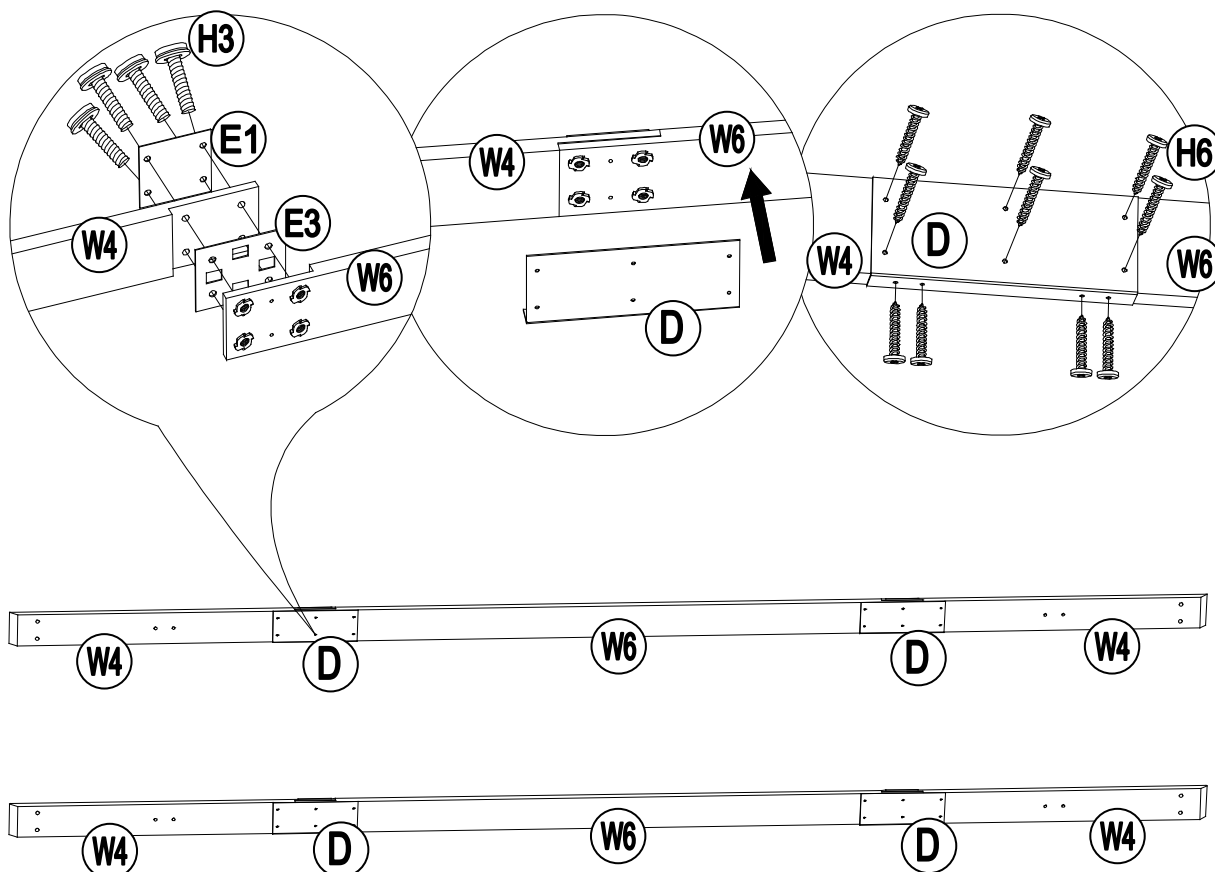
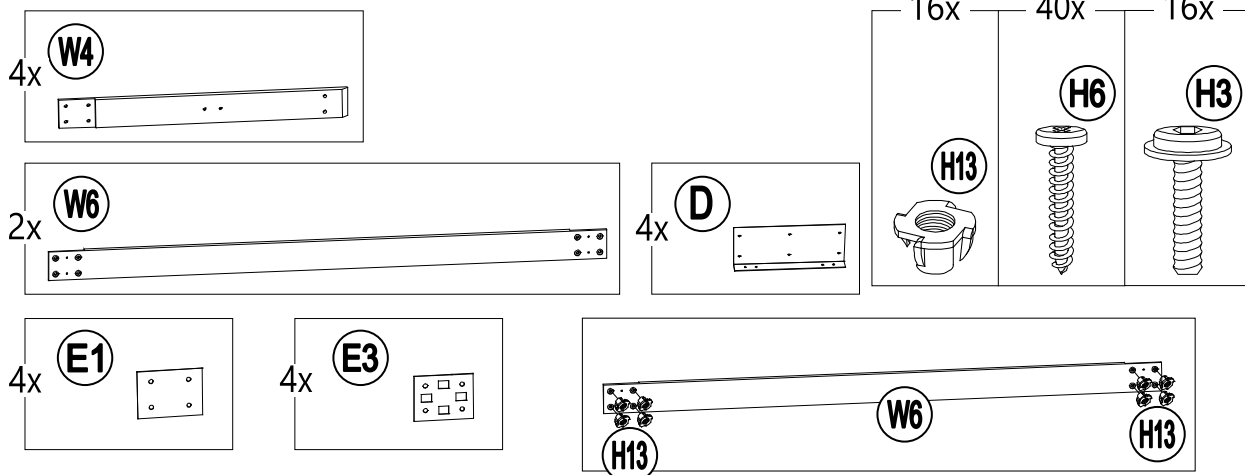

4

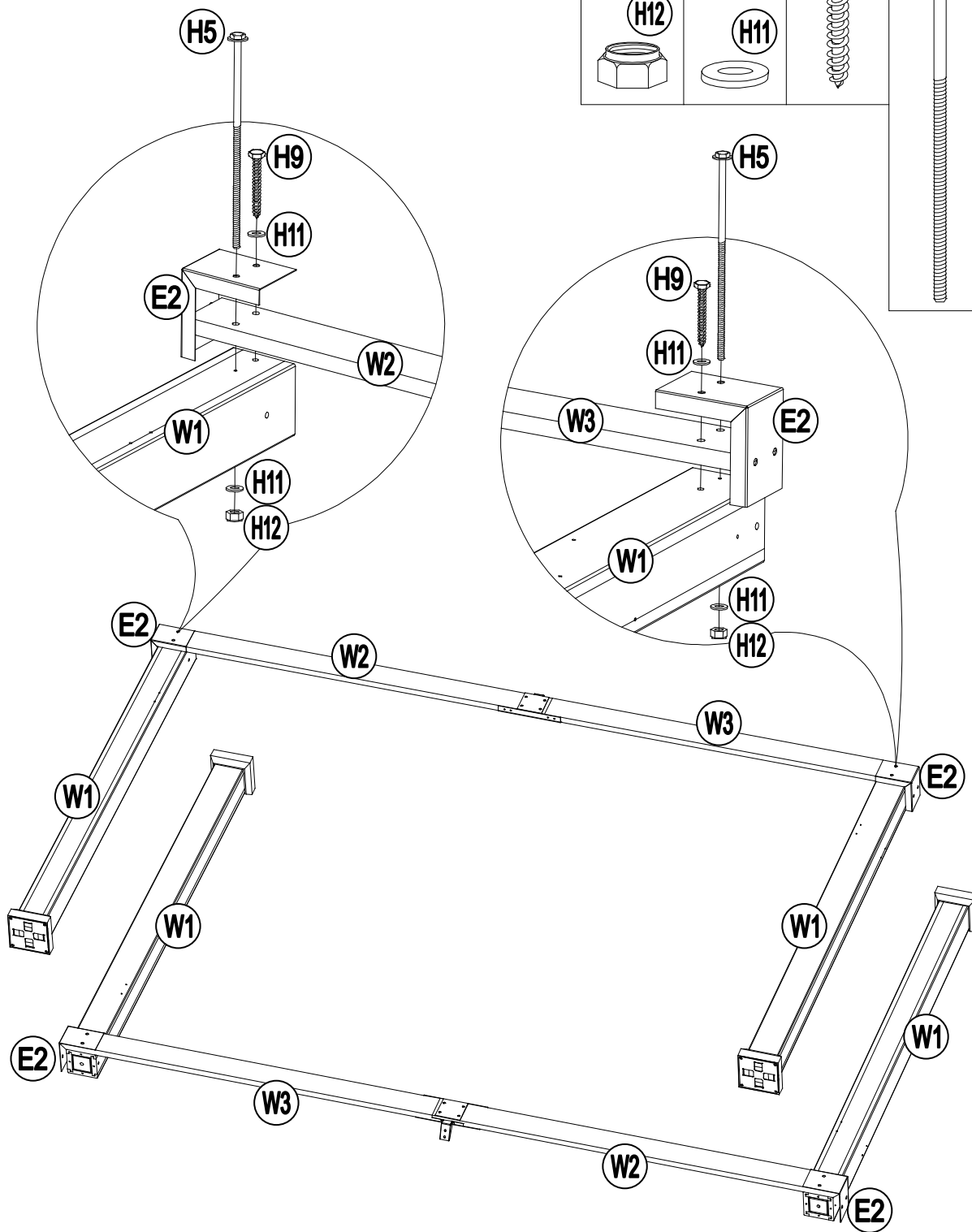
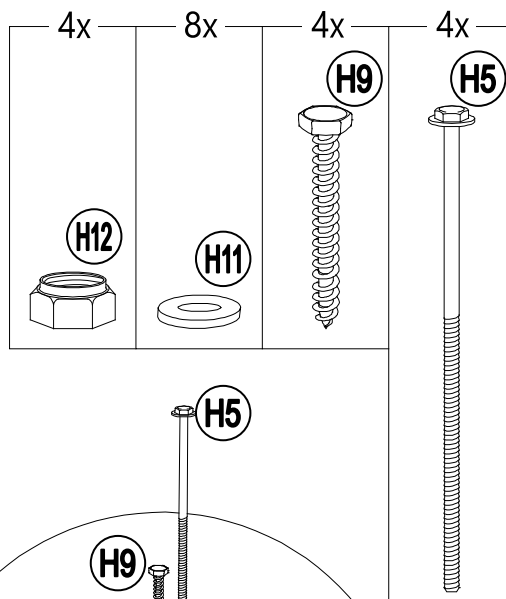
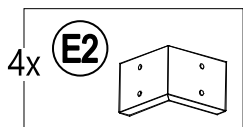

5

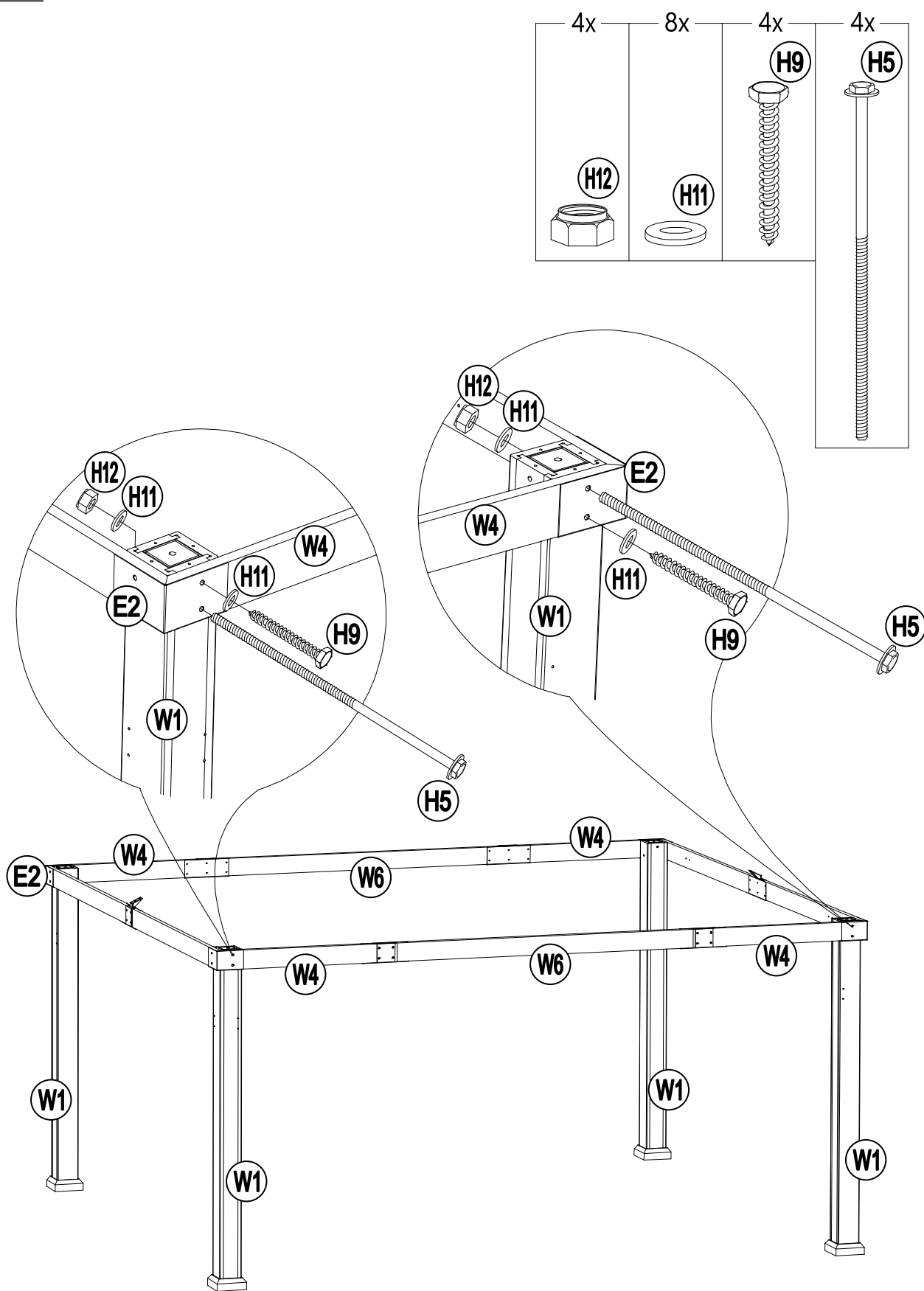

6

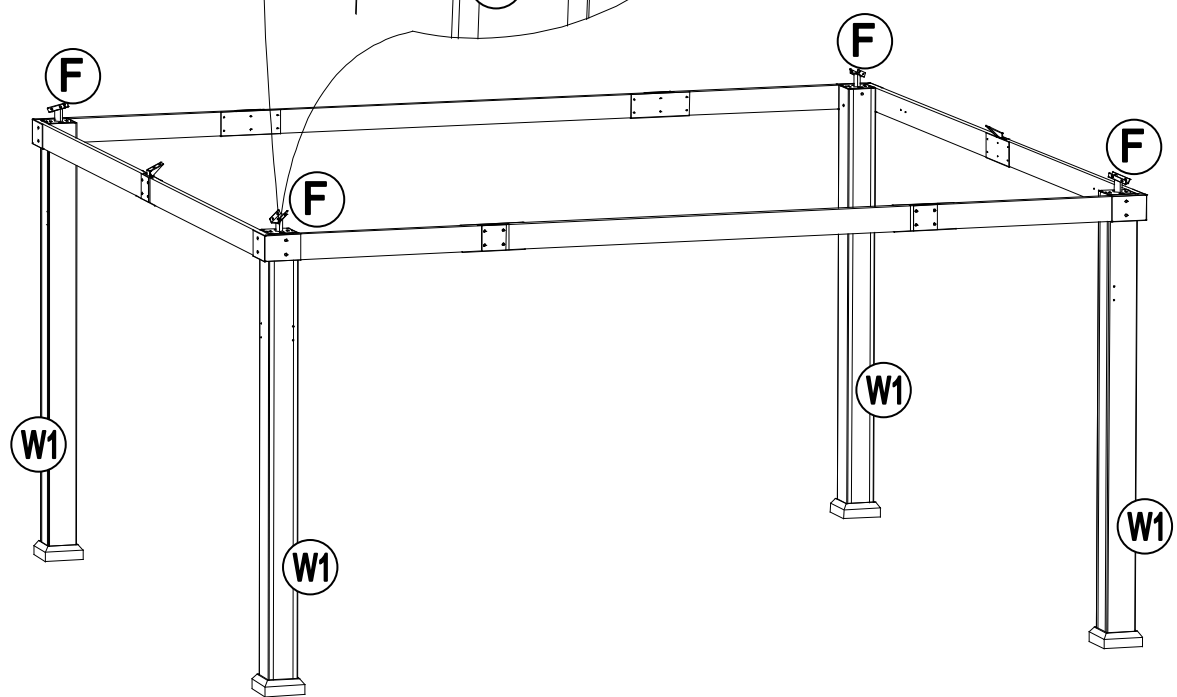
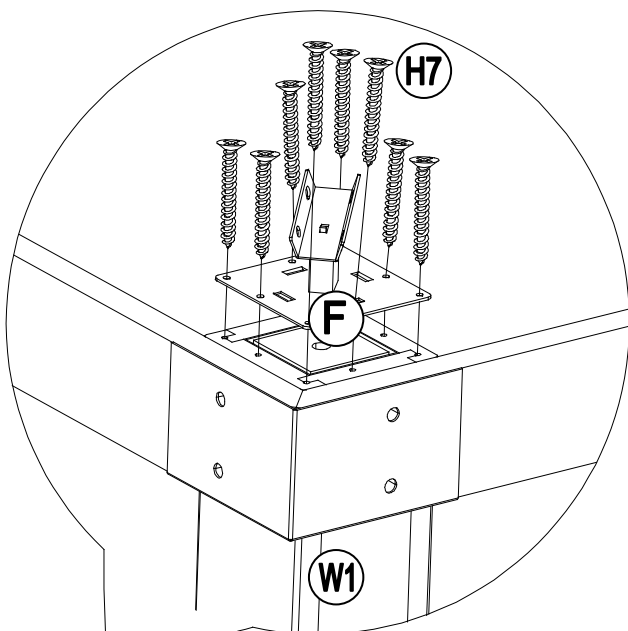
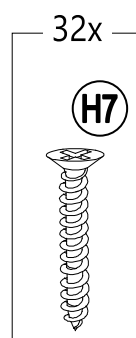
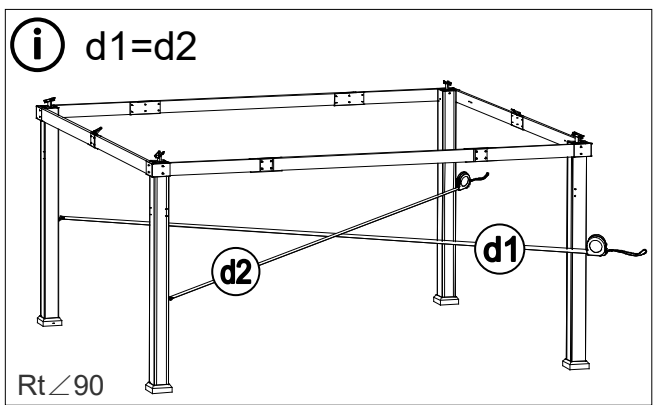
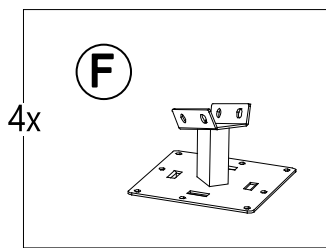

7

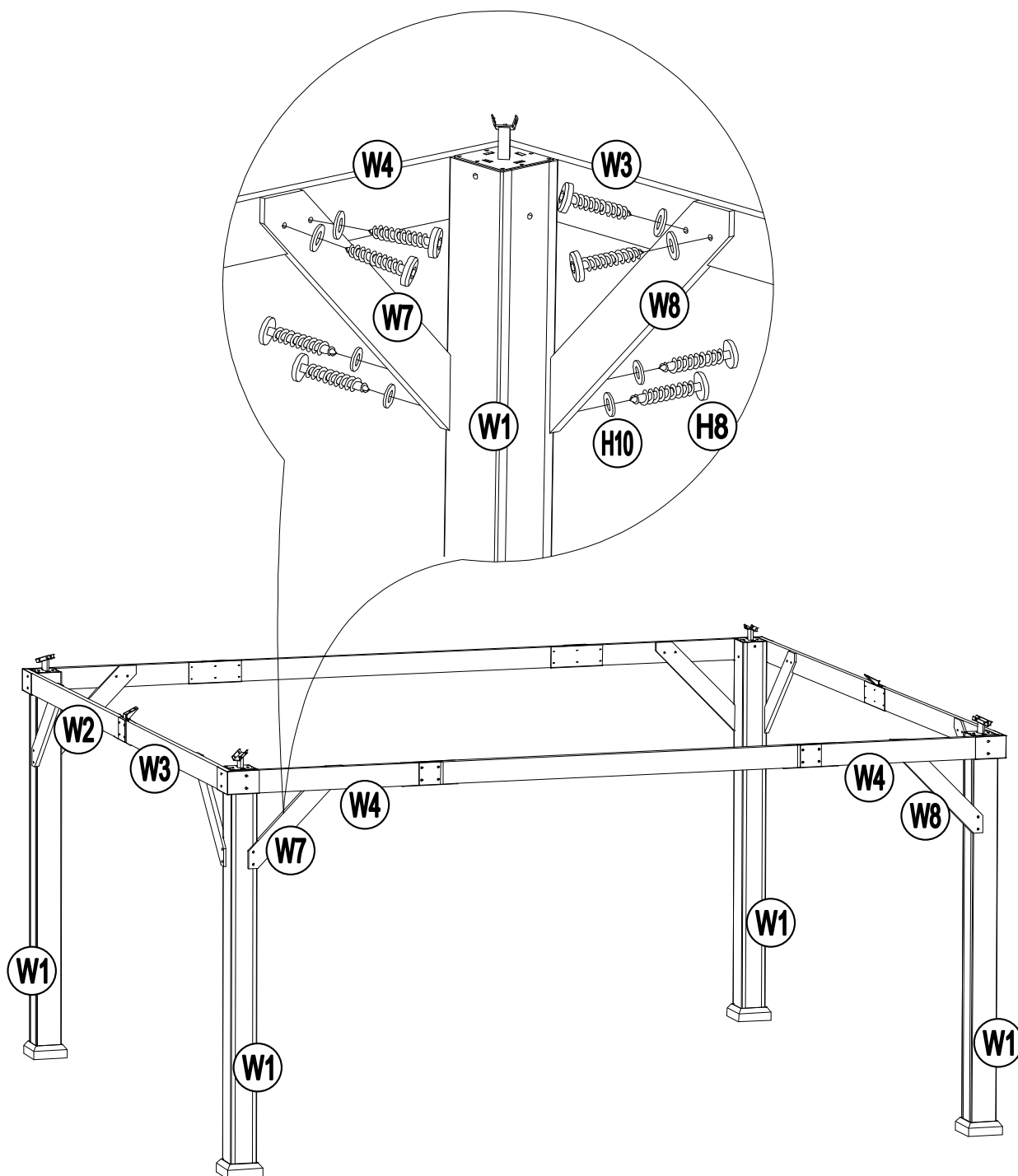
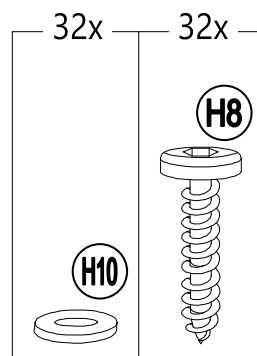
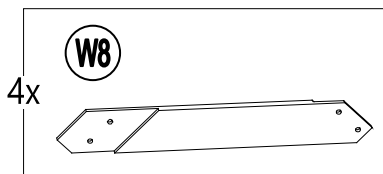
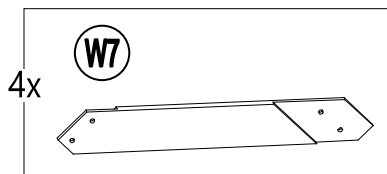

8

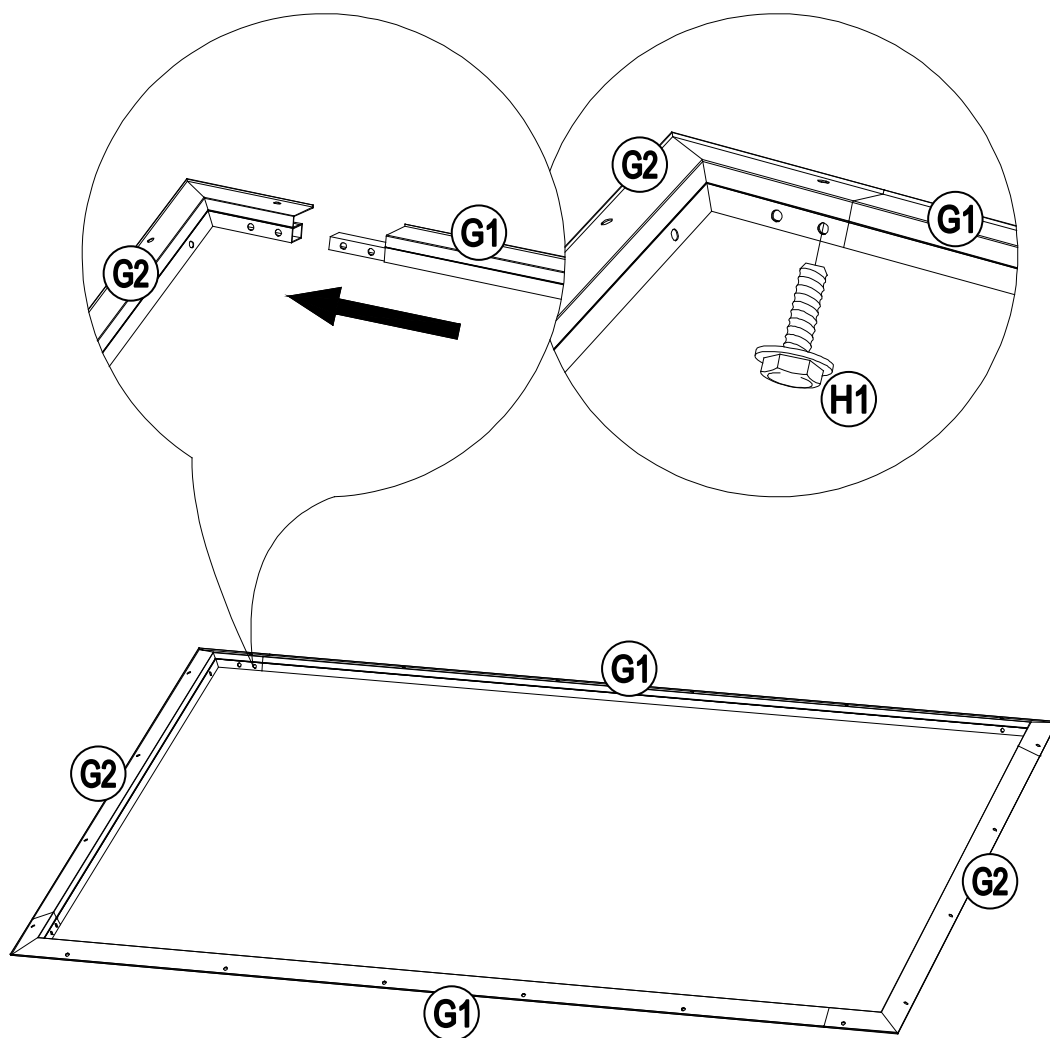
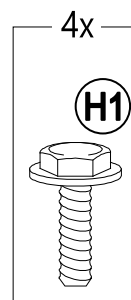
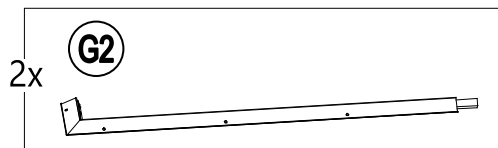
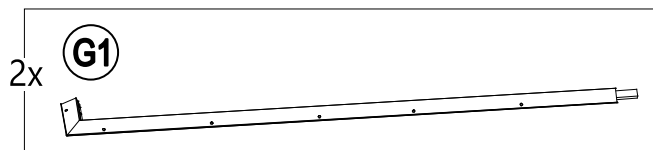

9

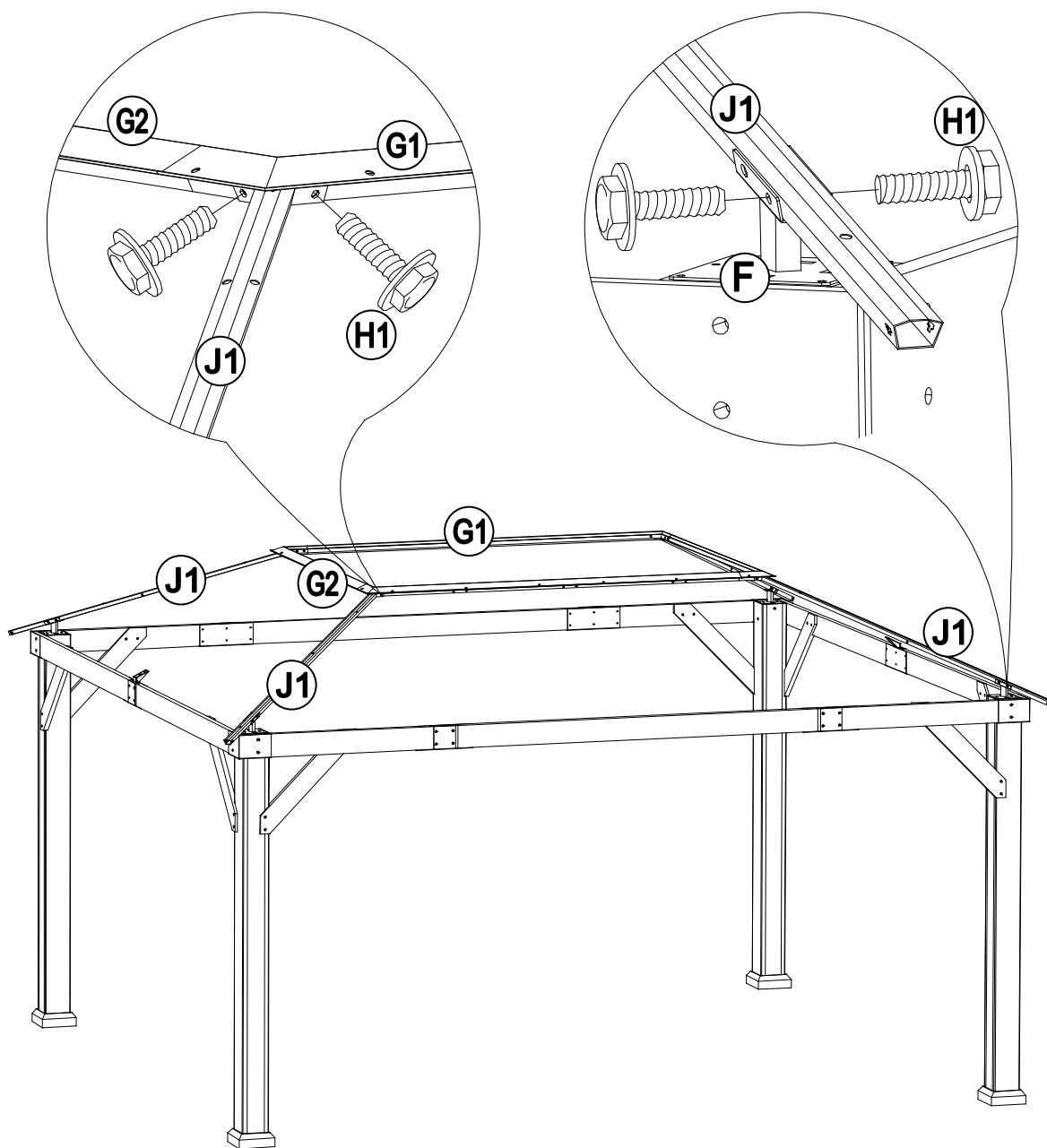
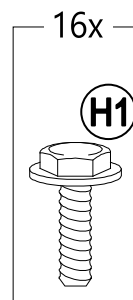
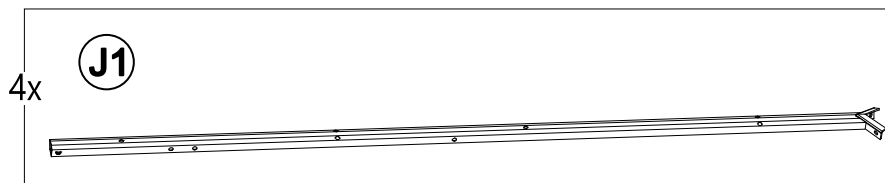

10

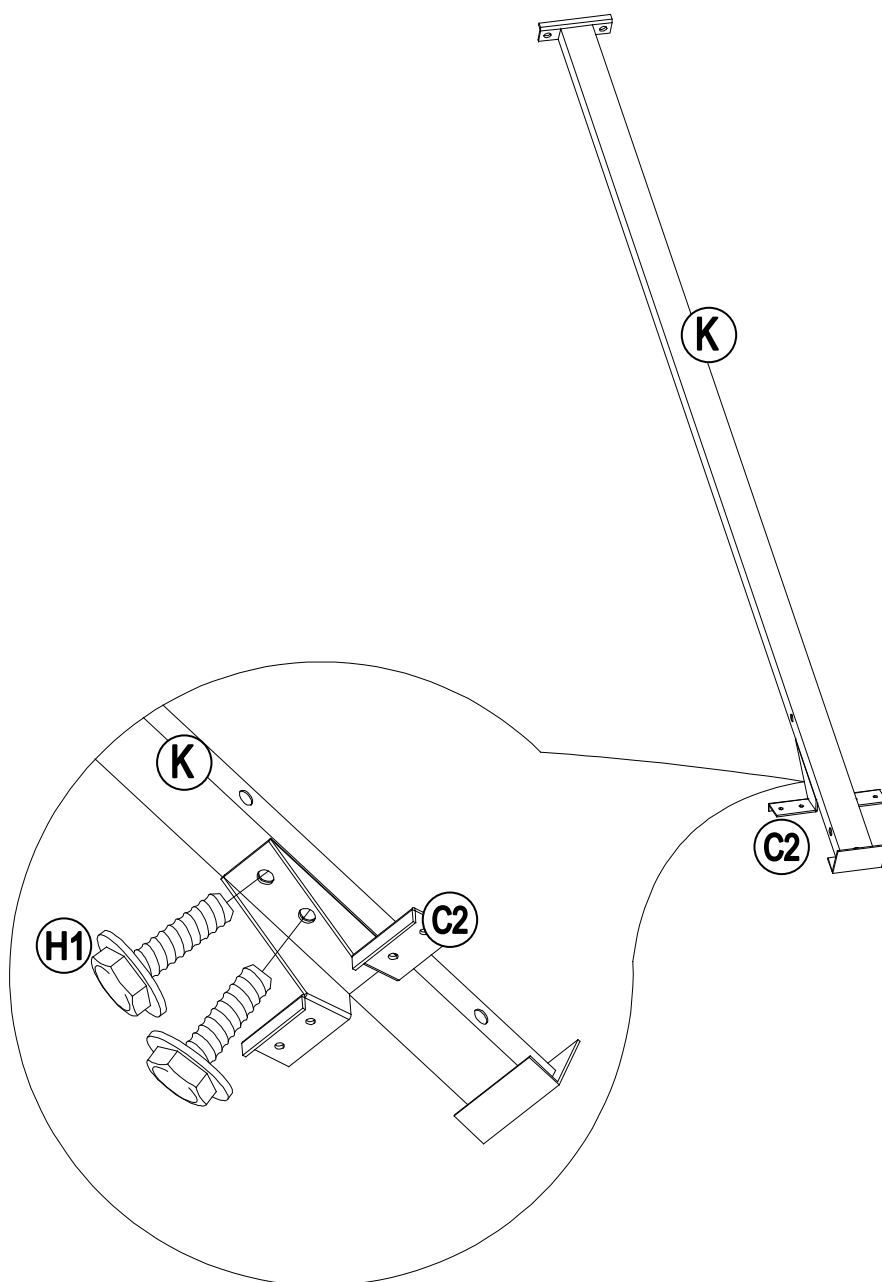
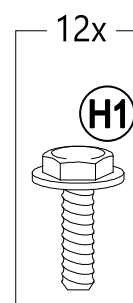
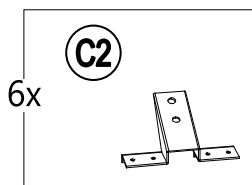
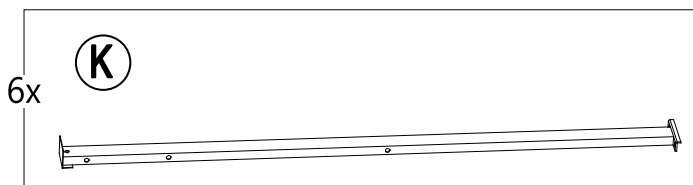

11

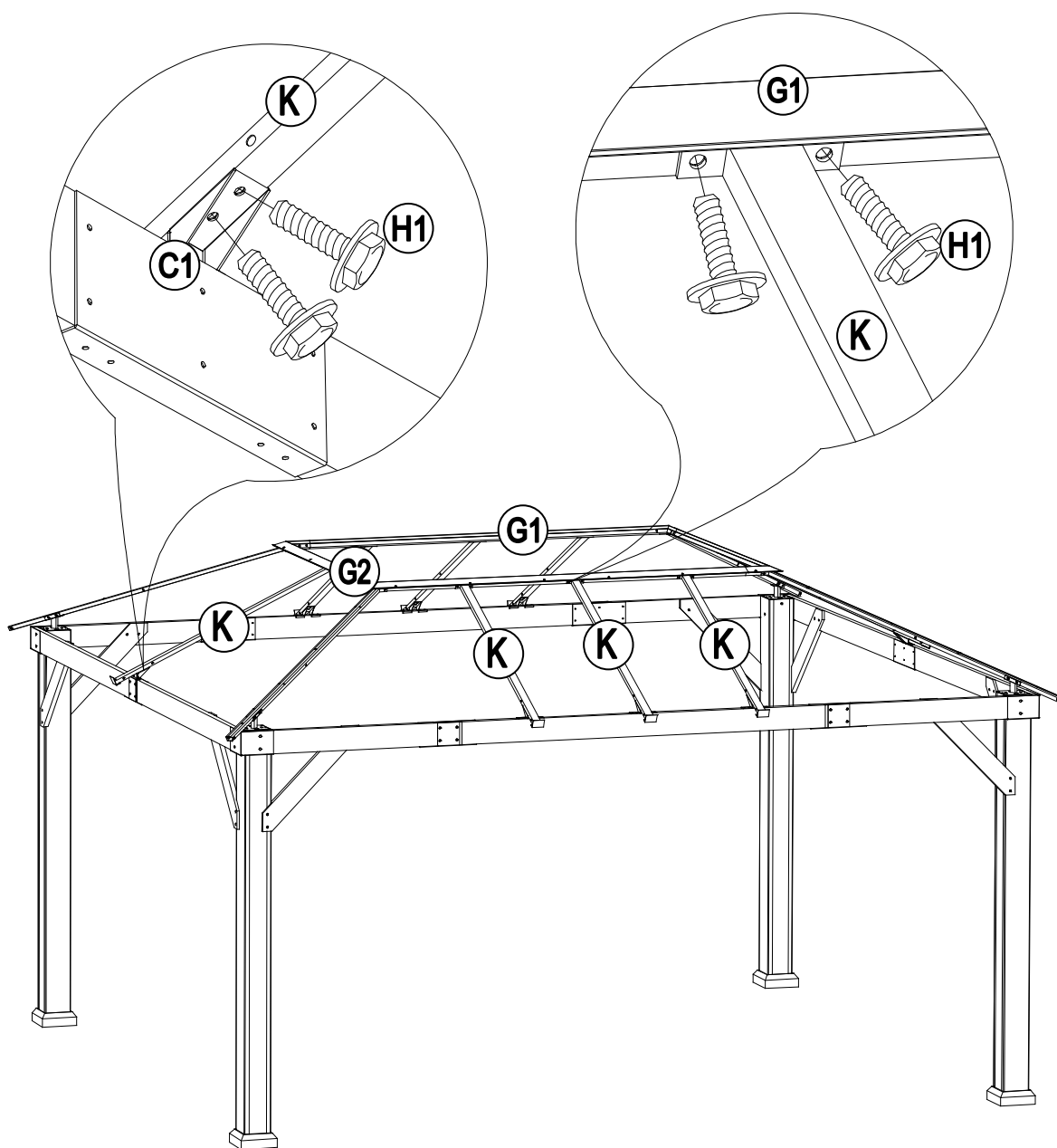
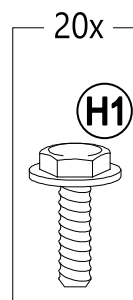
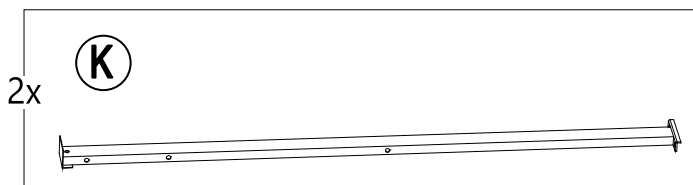

12

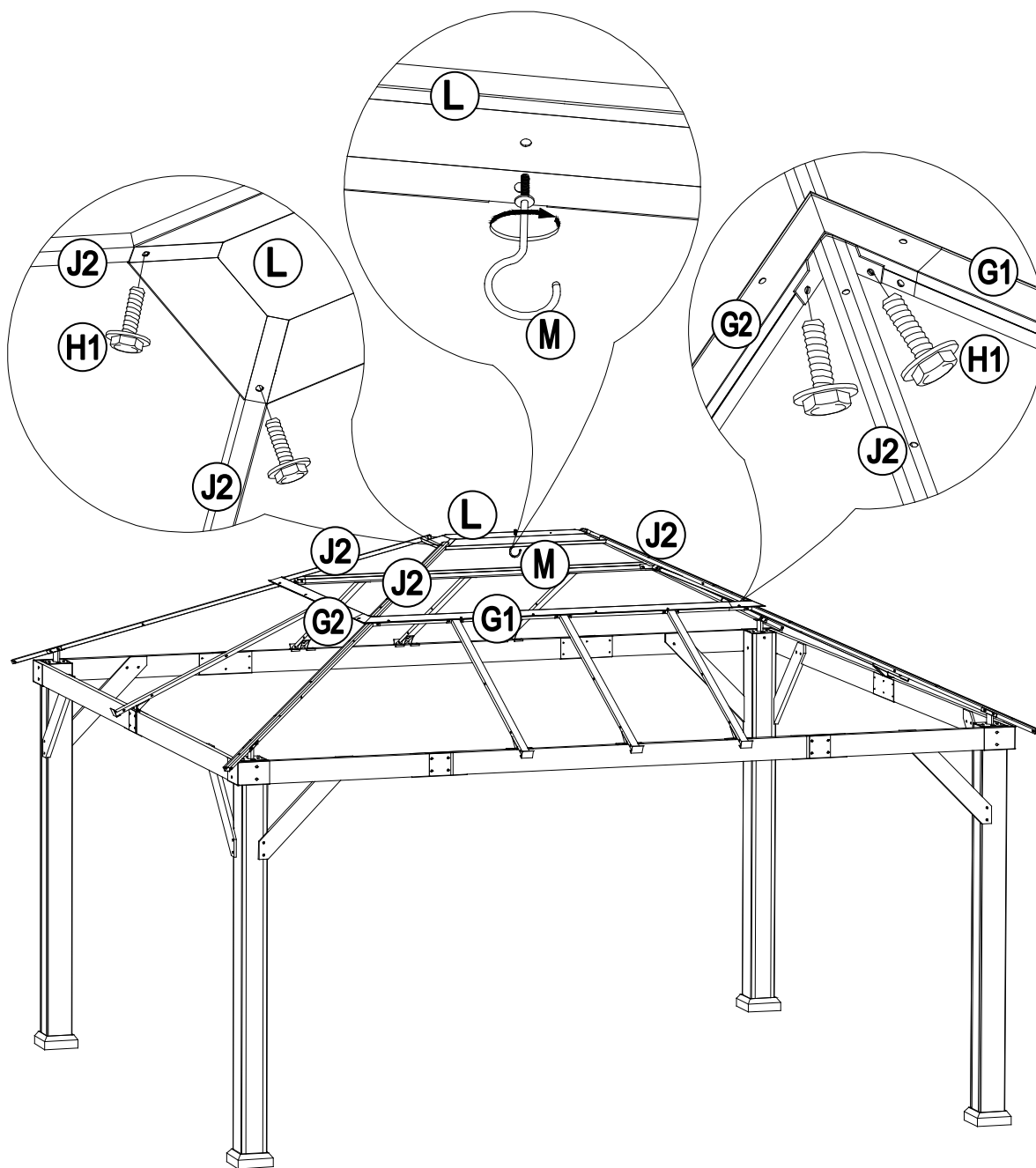
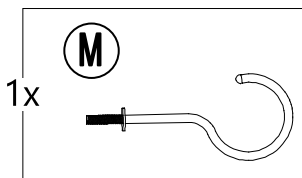
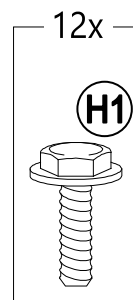
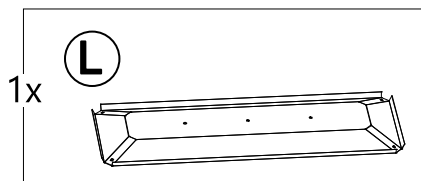
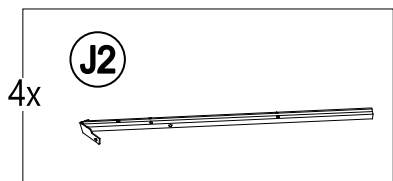

13

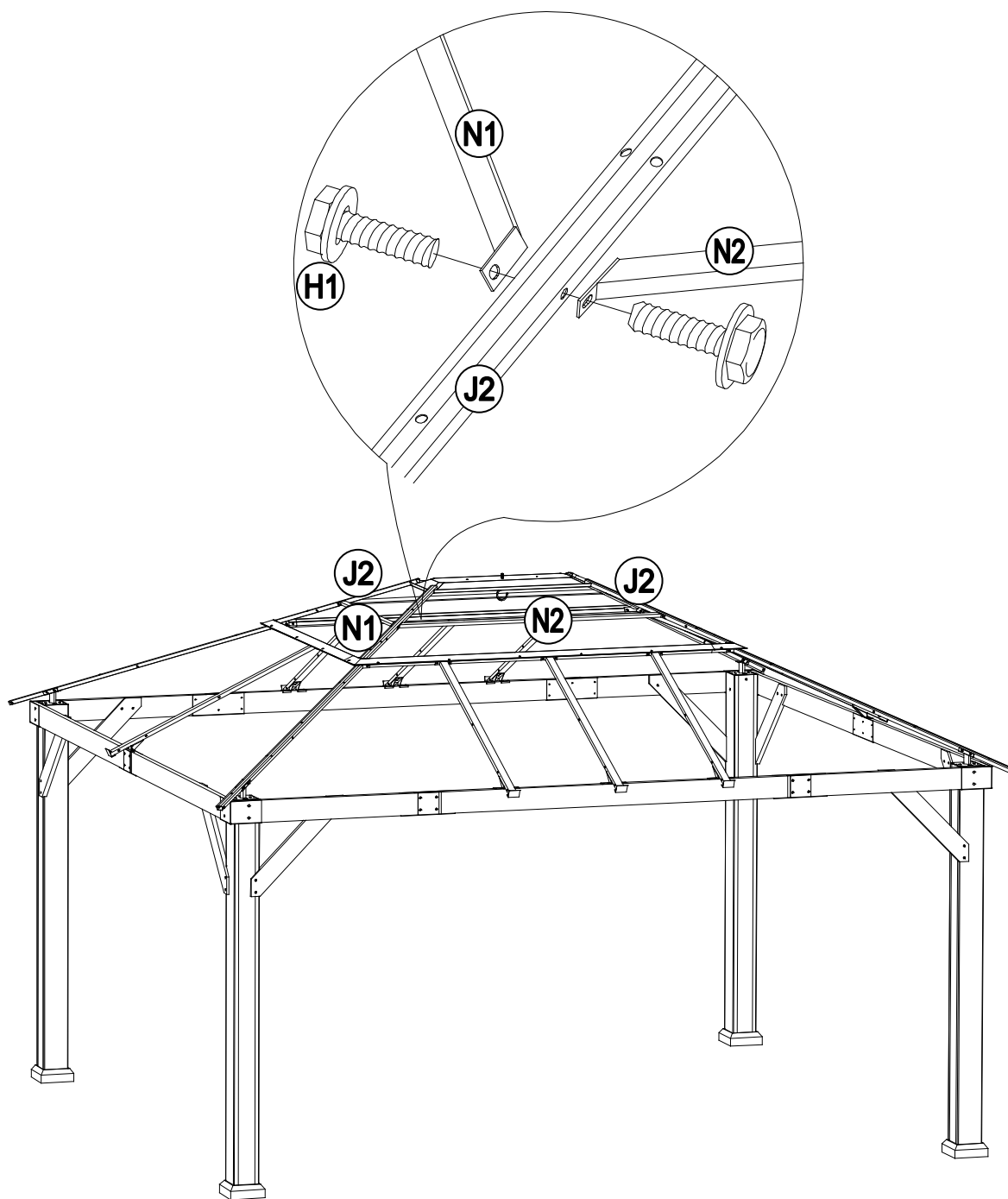
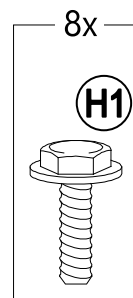
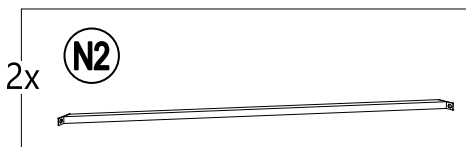
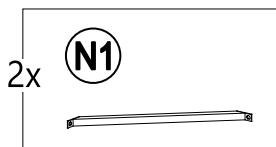

14

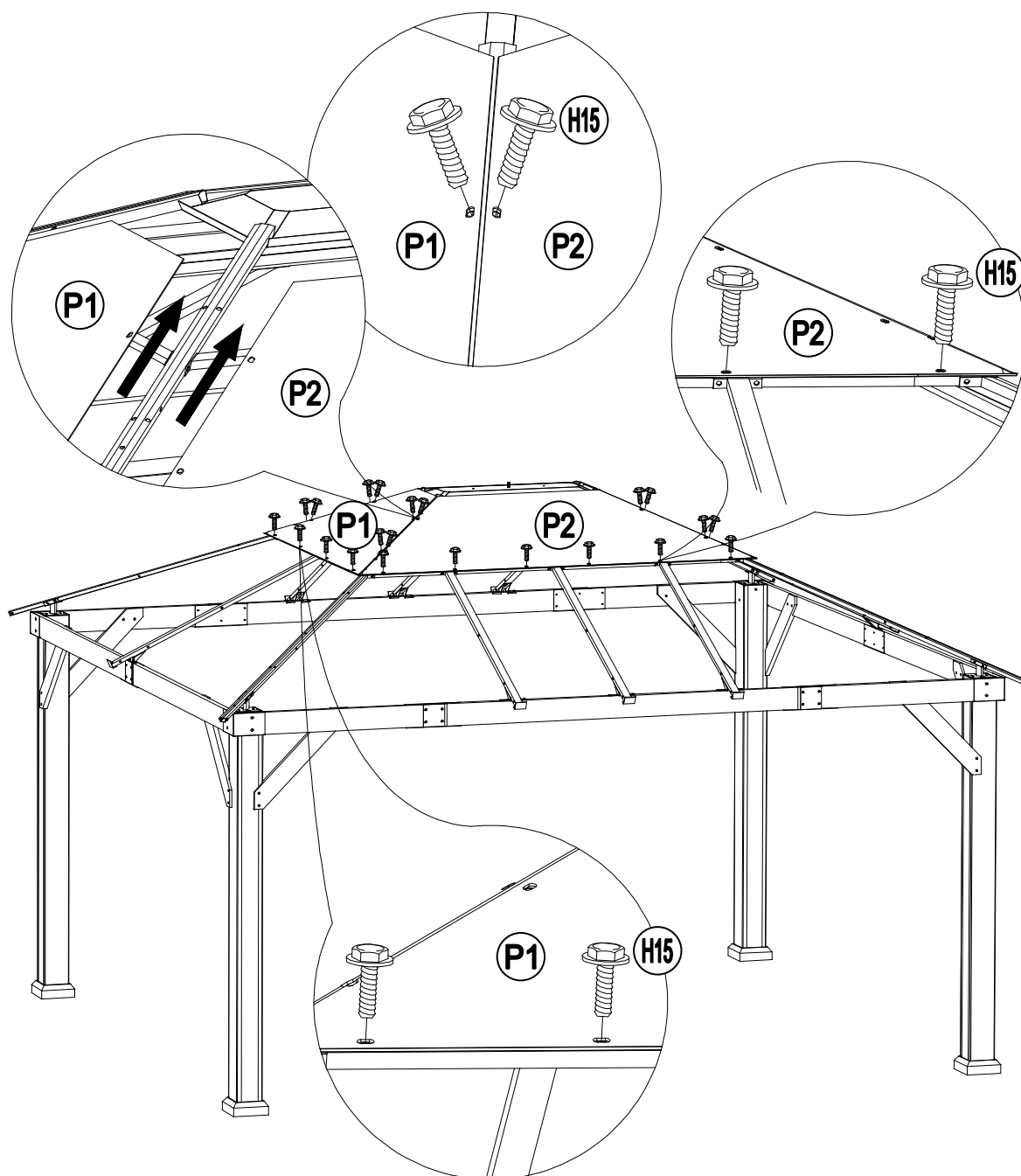
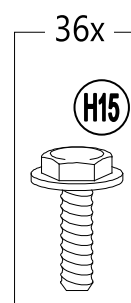
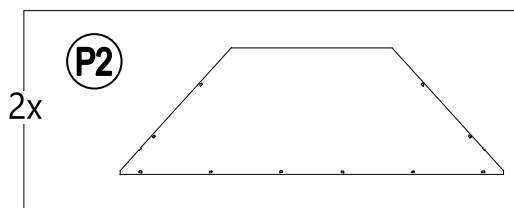
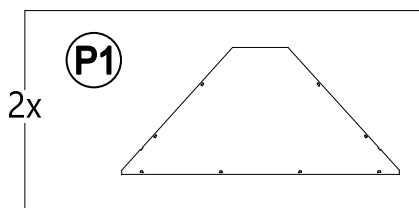

15

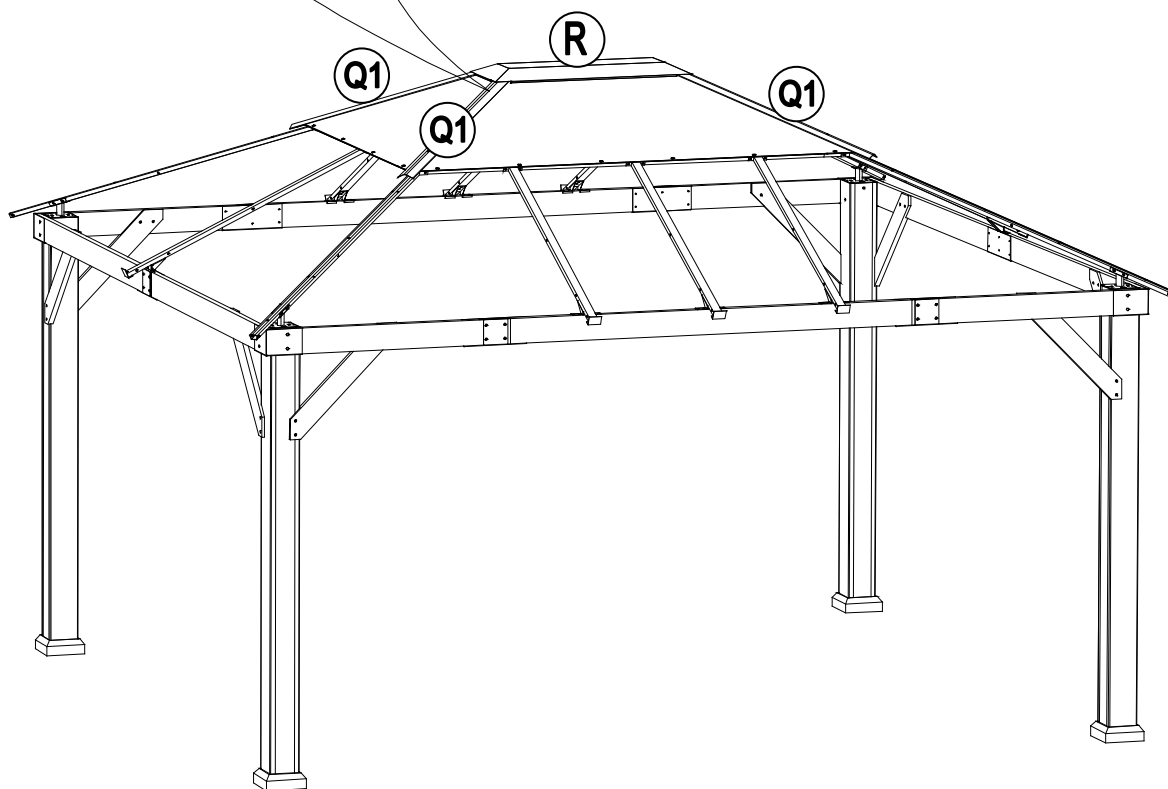
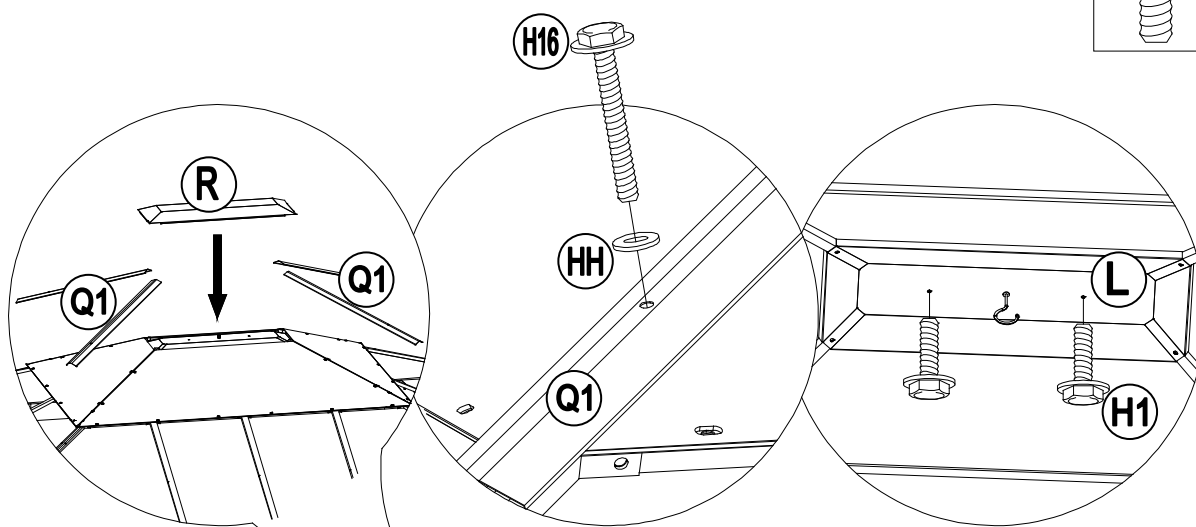
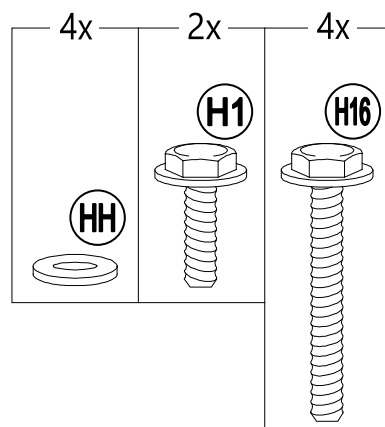
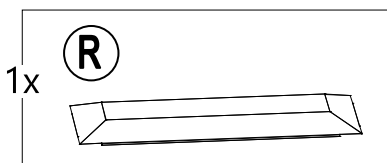
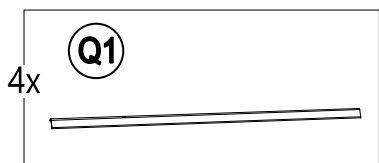

16

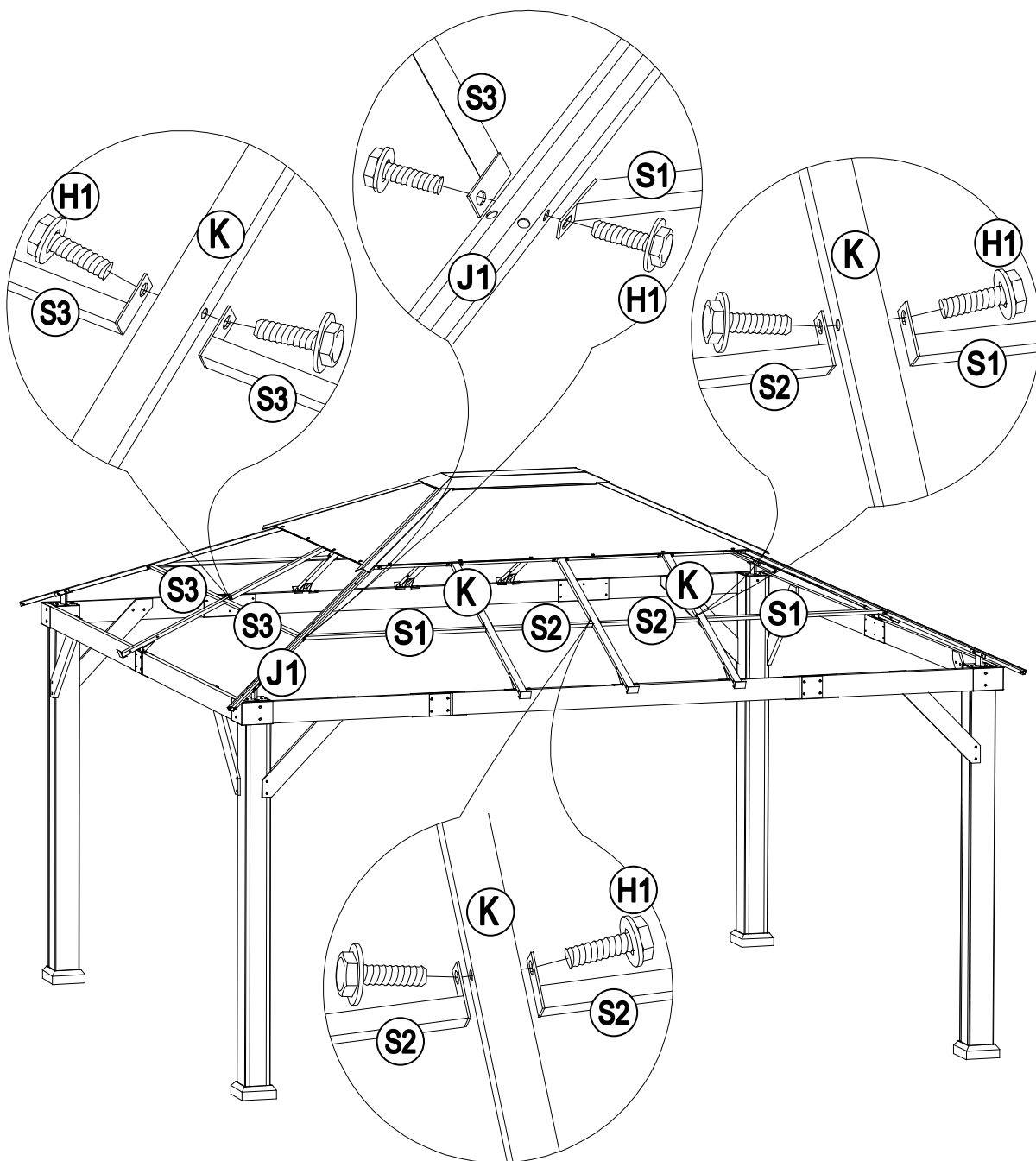
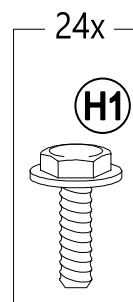
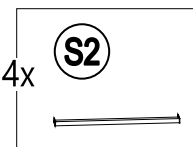
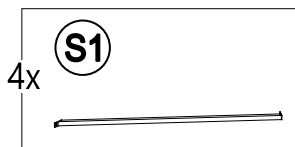

17

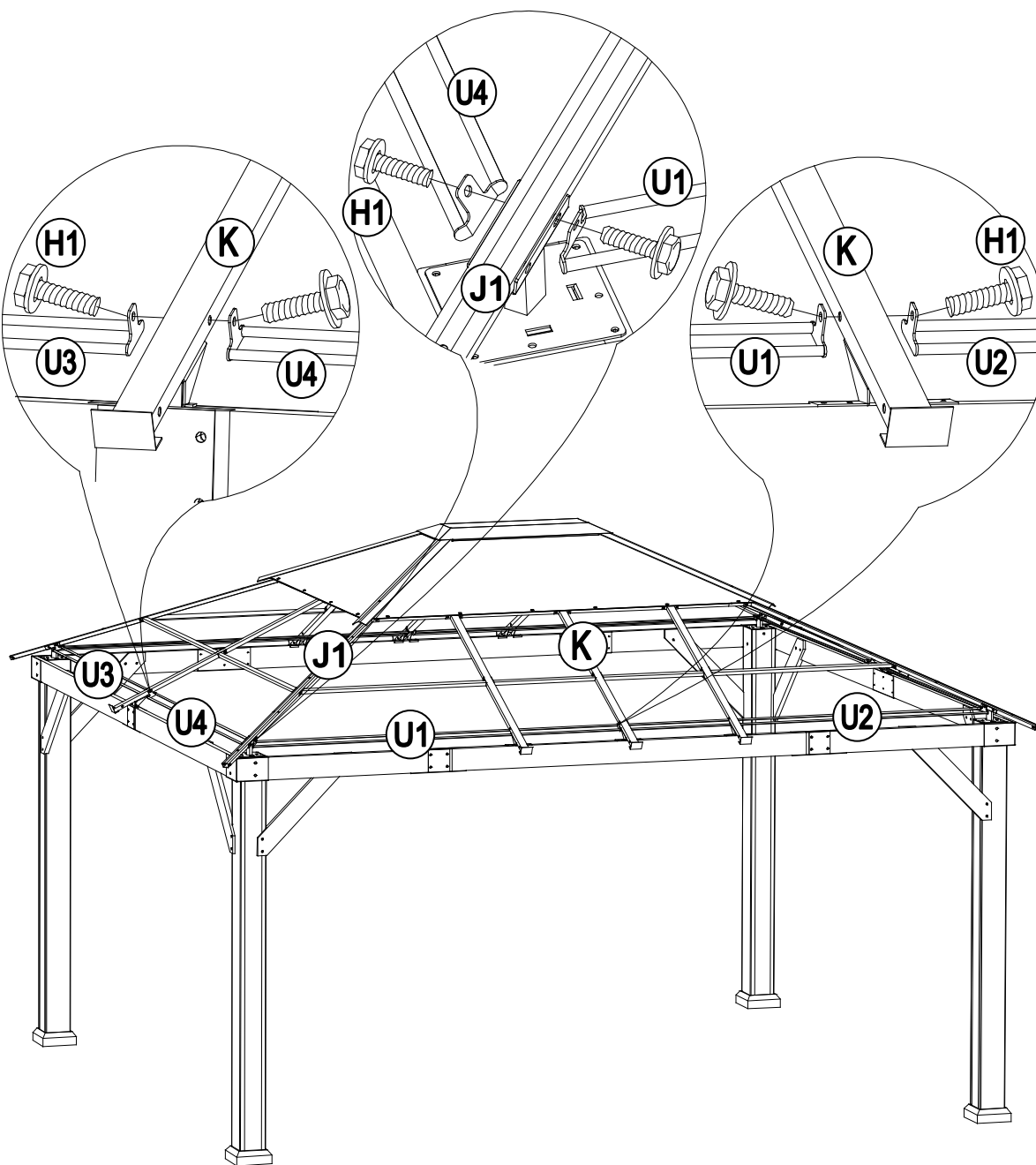
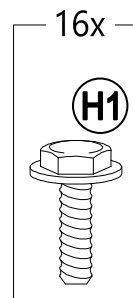

18

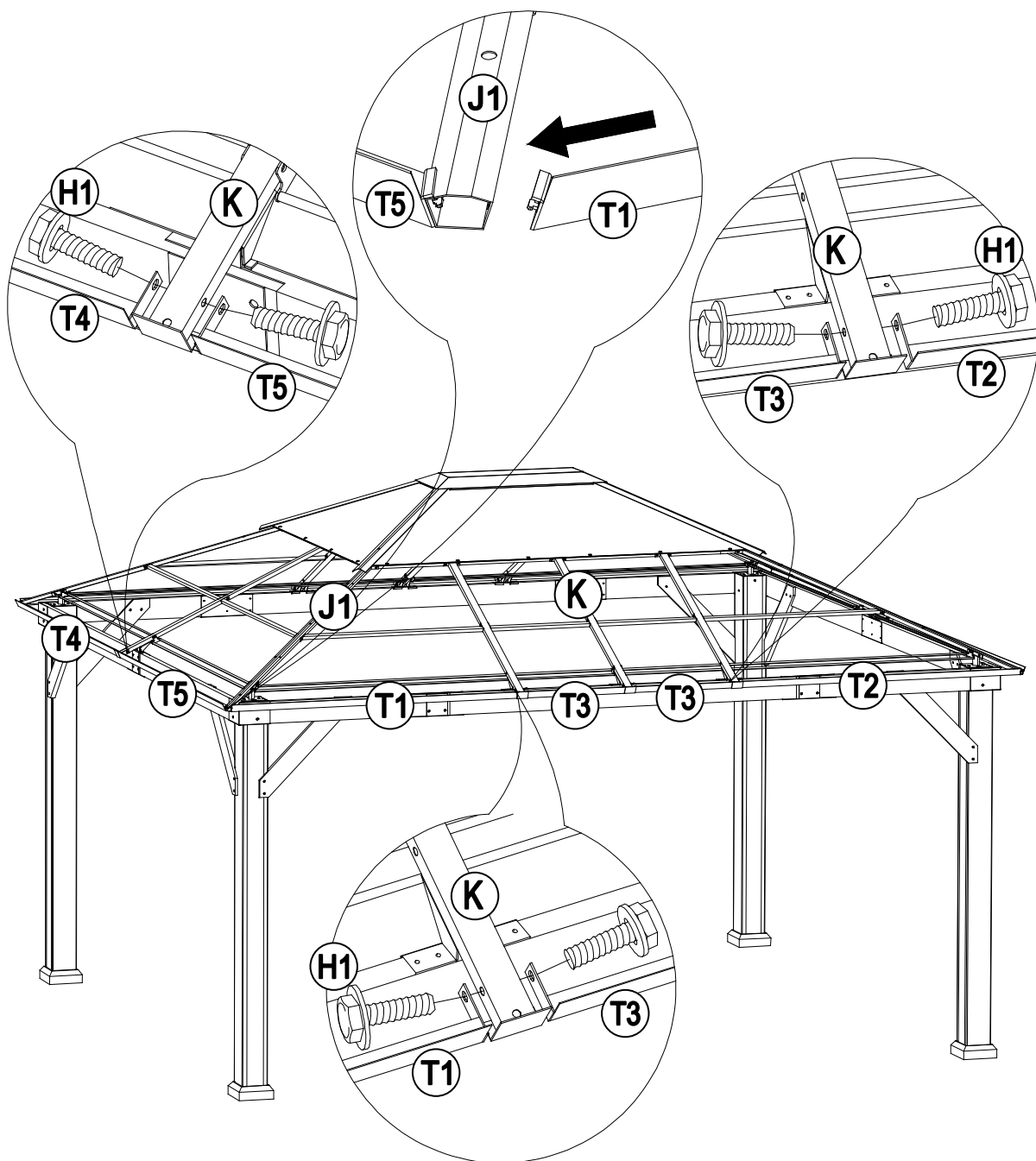
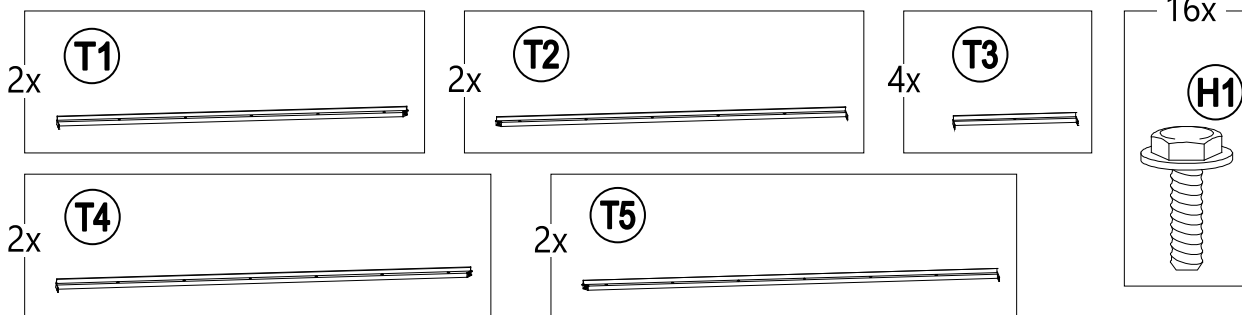

19

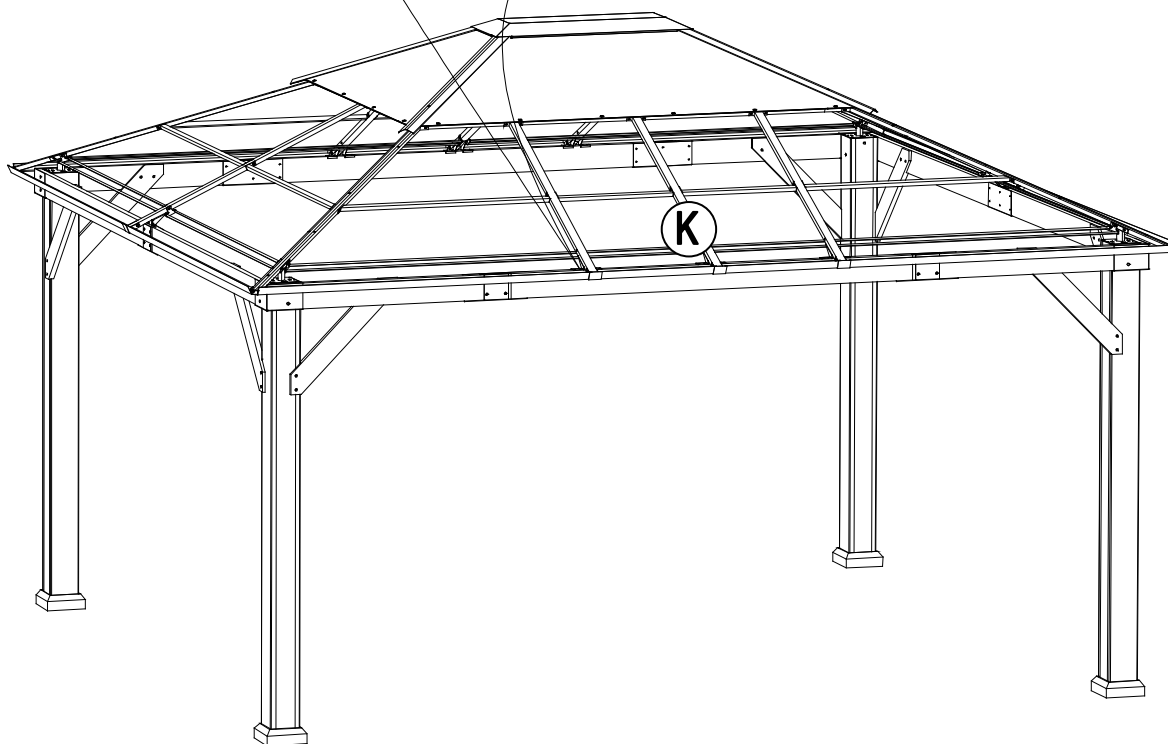
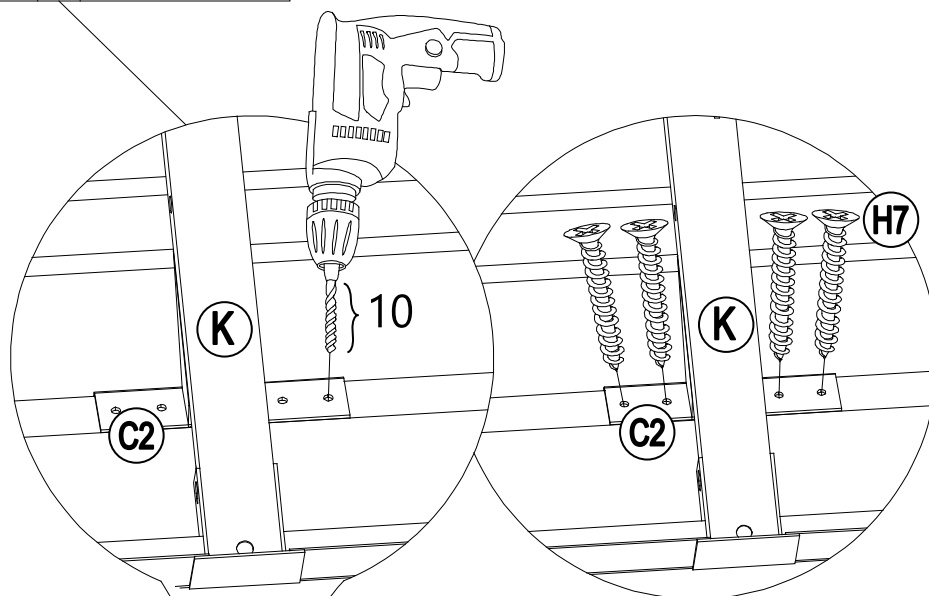
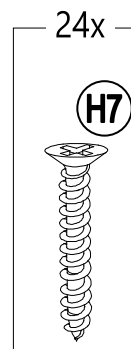
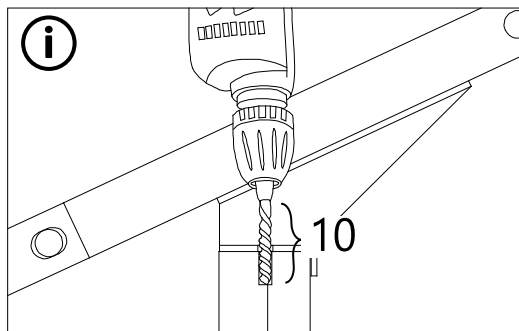

20

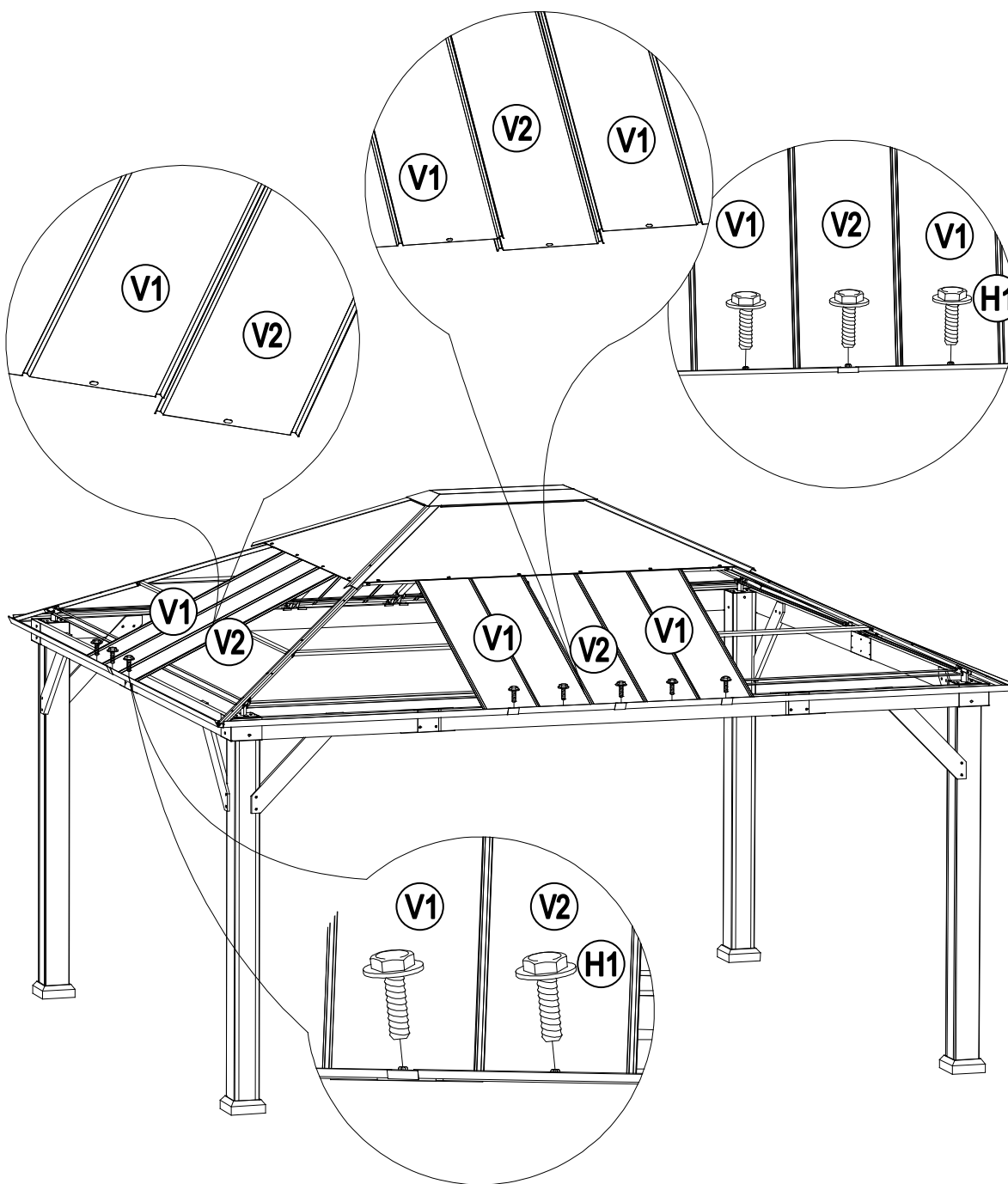
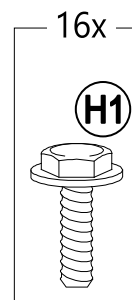
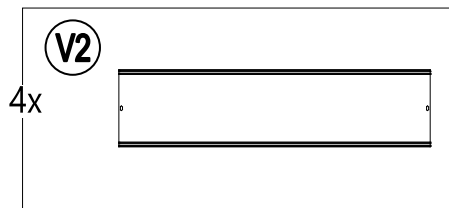
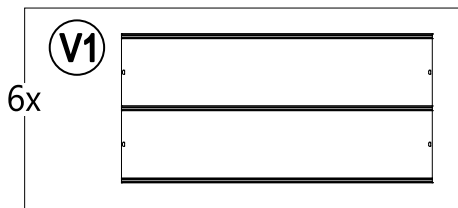

21

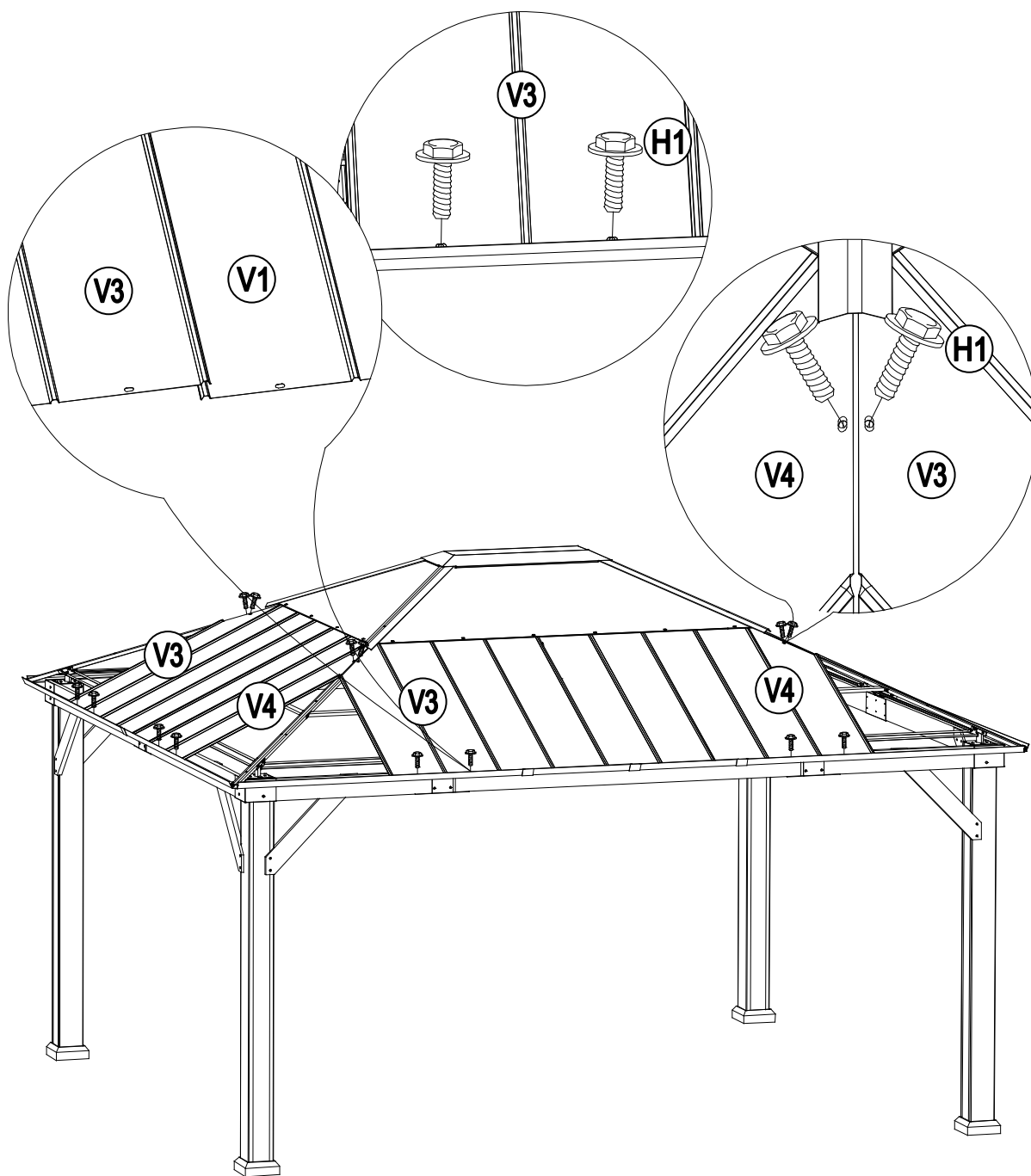
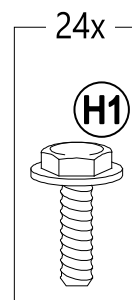
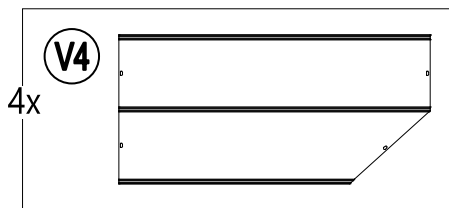
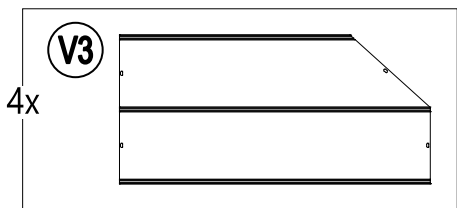

22

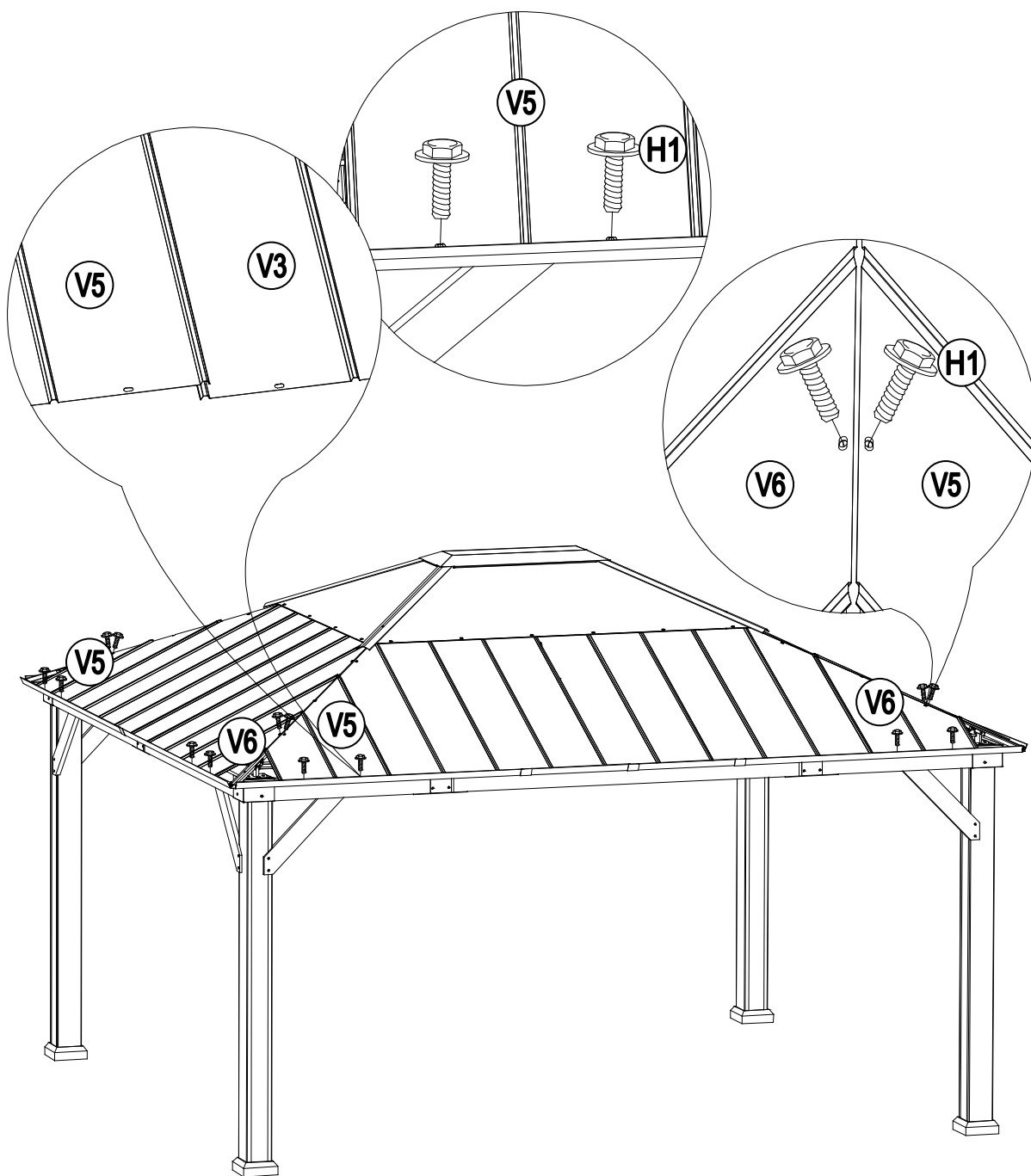
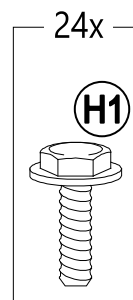
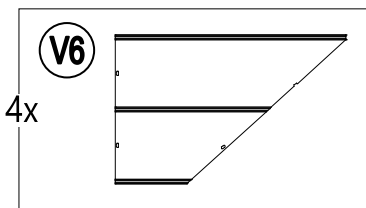
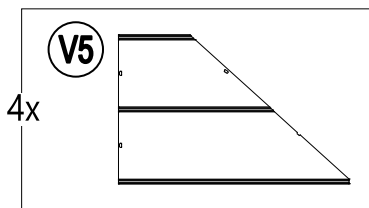

23

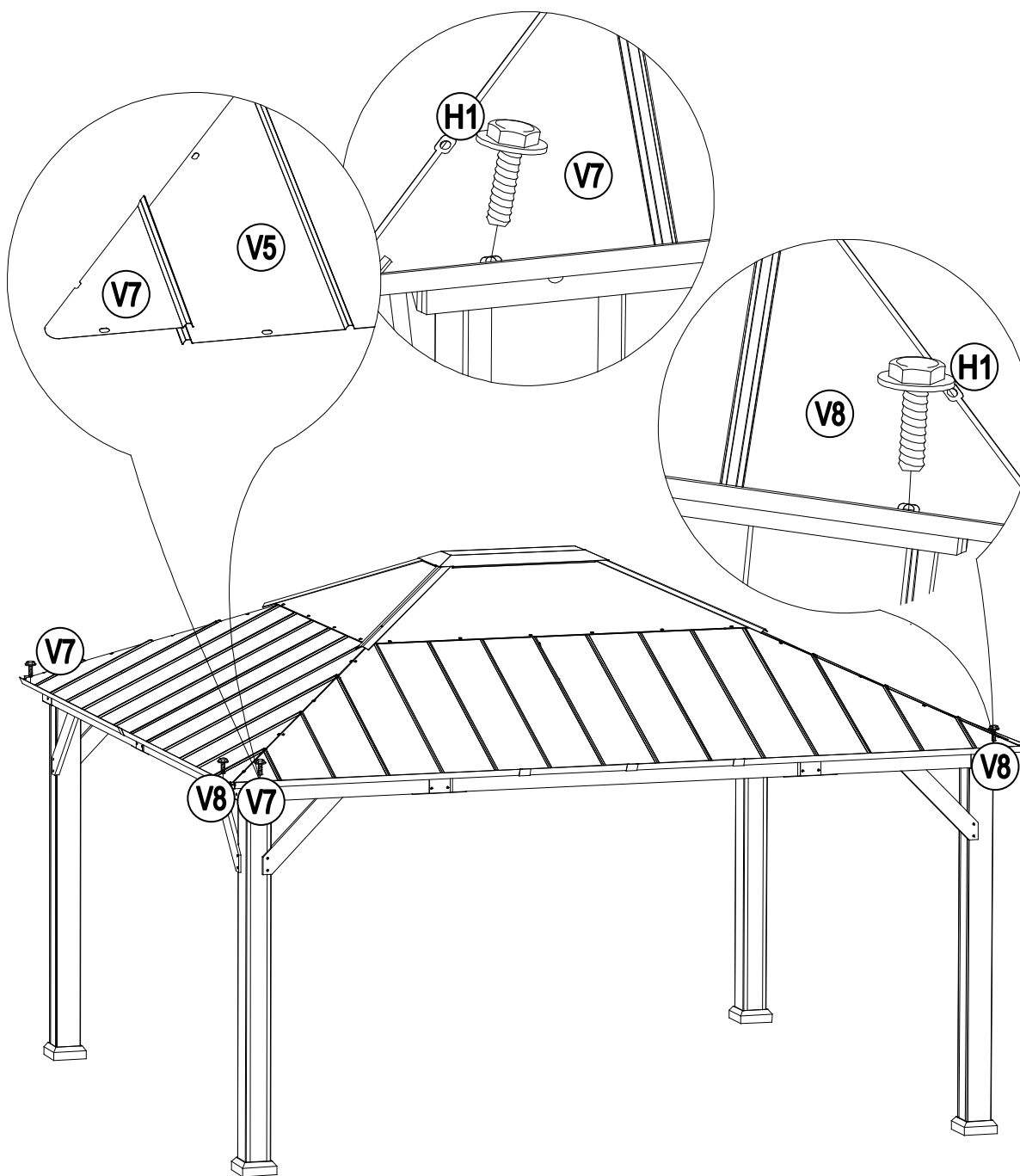
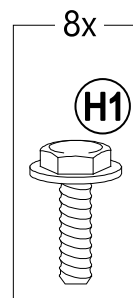
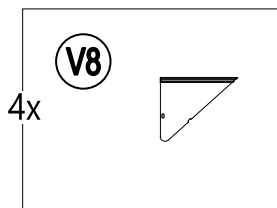
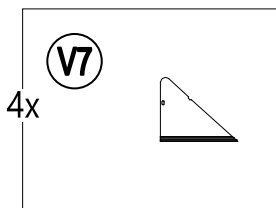

24

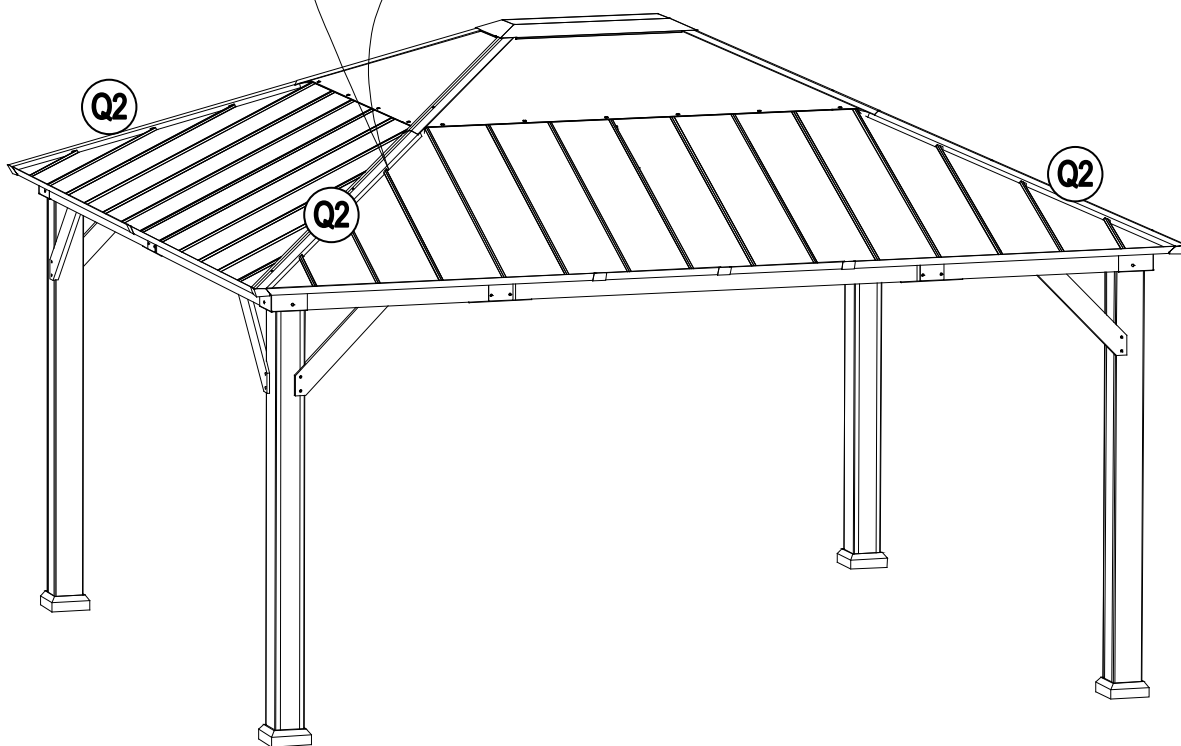
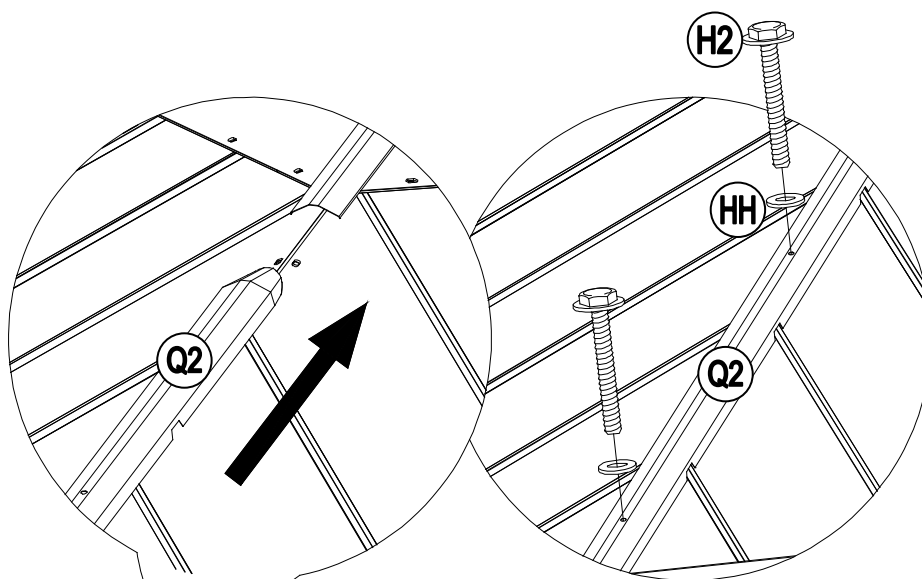
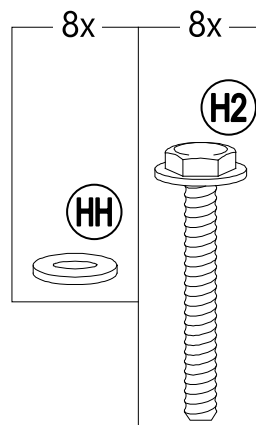
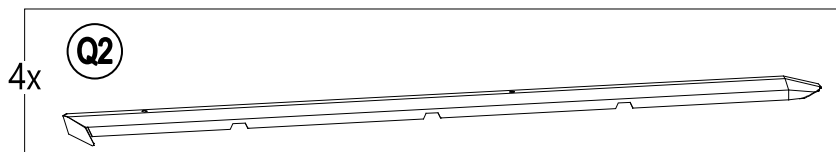

25

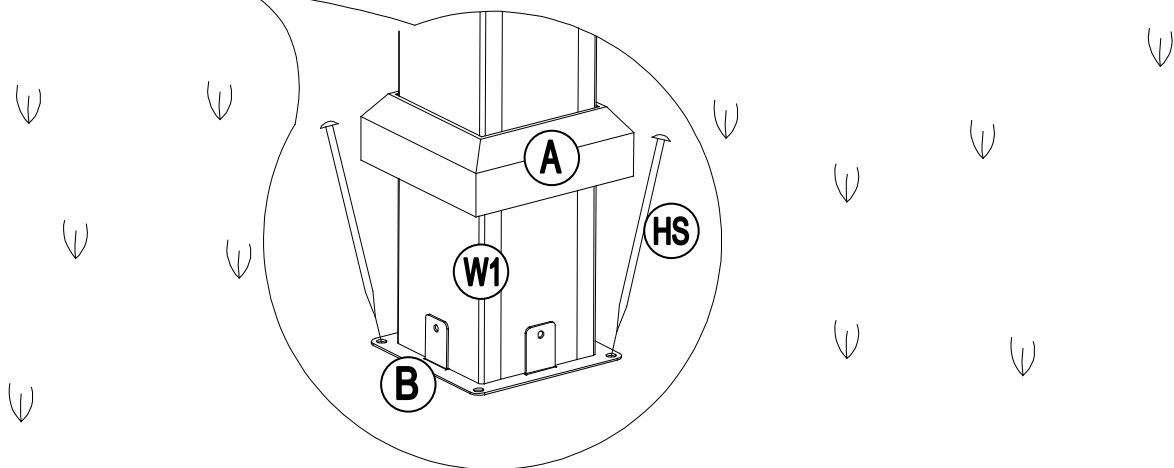
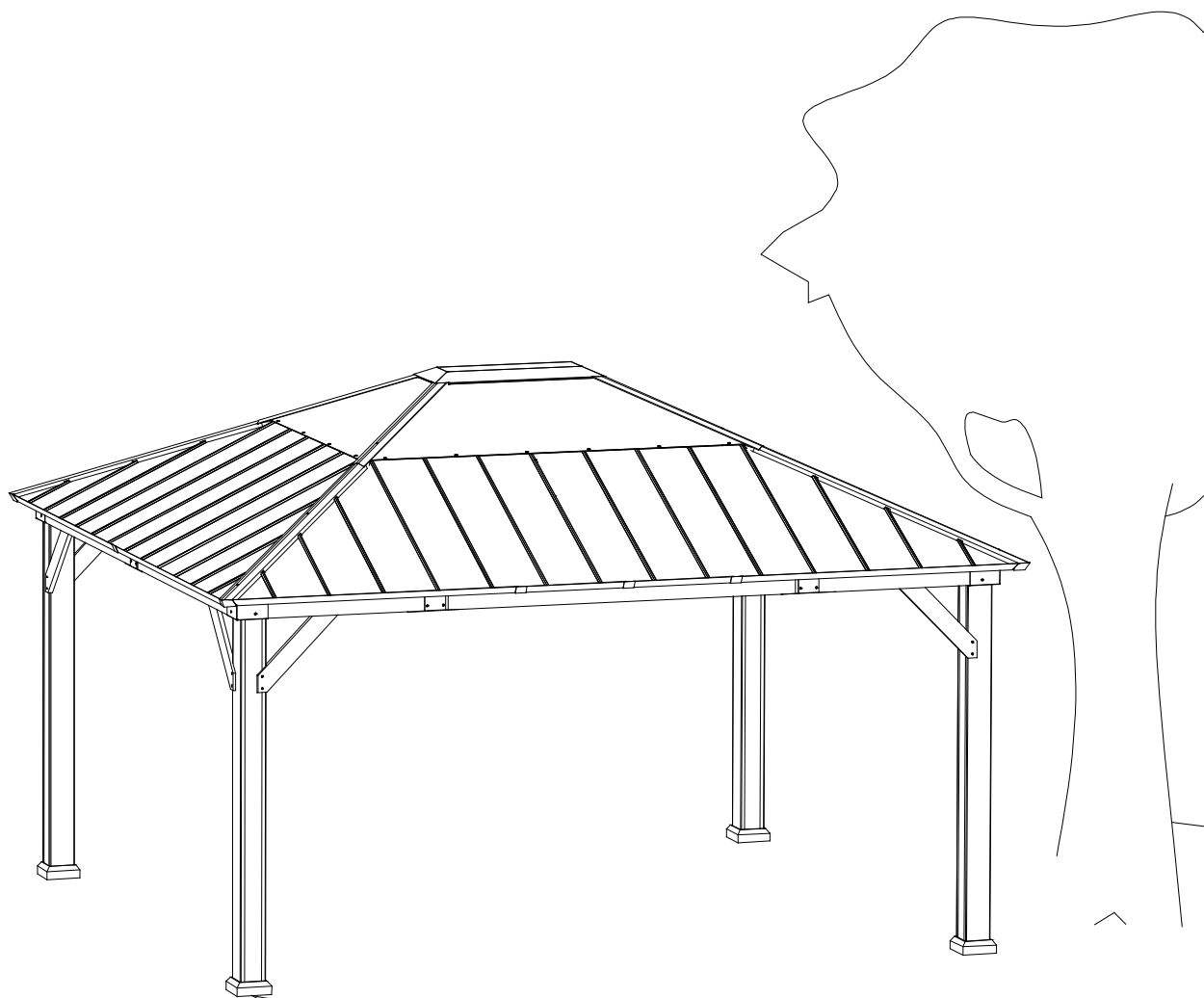
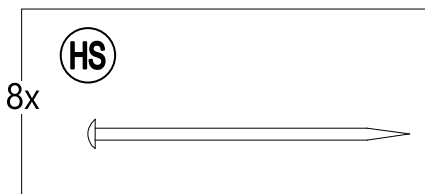

WOOD CARE GUIDELINES

Wood requires some care and attention over its lifetime to ensure a long-lasting beautiful finish. Proper cleaning and maintenance will keep your wood products looking beautiful for a long time. Please follow these guidelines to maintain your wood surfaces.

- **Fading and weathering:** Wood is a natural product and is expected to change over time. Long periods of sun exposure can naturally lead to color fading. Weather extremes, temperature fluctuations, and humidity highs/lows cause wood to expand and contract, possibly leading to warping and cracking. Knots and small surface cracks are naturally occurring and do not affect the strength of the product.
- **Keeping dry:** Prolonged moisture and high or low humidity can be harmful for wood. Cracking or splitting from extremes outside of the normal humidity range of 35-65% are not covered by our warranty. Preventing prolonged exposure to moisture is advisable.
- **Cleaning:** Frequent light cleaning is recommended. Dust regularly using a slightly damp soft cloth, and then wipe dry (following the direction of the wood grain). For more thorough cleaning, use a soft cloth and a gentle soap solution (dilute ¼ cup mild dishwashing liquid soap with 1 gallon of warm water). Rinse with water, and then immediately dry the surfaces using a soft cloth. Do not use bleach, acid, or other solvents on any metal parts or surfaces. Minor stains or scratches can be lightly buffed with No.0000 steel wool, followed by an application of good quality wood-care oil, wiping in the direction of the grain.
- **Annual sealing:** It is advisable to annually maintain the wooden parts with a sealant or outdoor wax/oil to protect and enhance the wood surfaces. Twice yearly, after cleaning, apply a good quality wood-care oil or water-based sealant to the surfaces. Recommended options are outdoor water-based sealant, linseed, teak, or tung oil. Refer to the manufacturer's specific instructions for application. It is best to try on a small section of wood, then if satisfied with the result, continue the application, taking care to avoid any metal surfaces.
- For further questions and concerns, please contact:
customer.care@sunjoygroup.com

RECOMMANDATIONS POUR SOIN

Le bois exige un peu de soin et d'attention pendant sa vie pour assurer une belle finition durable. Le nettoyage et l'entretien convenables maintiendront la beauté de vos produits en bois plus longtemps. Veuillez suivre ces conseils pour préserver vos surfaces en bois.

- **Décoloration et érosion:** le bois est un produit naturel qui est prévu de changer avec le passage du temps. De longues périodes d'exposition au soleil peuvent naturellement conduire à la décoloration des couleurs. Les extrêmes météorologiques, les fluctuations de la température et les hauts / bas d'humidité provoquent l'expansion et la contraction du bois, ce qui peut entraîner à la déformation et aux fissures. Les nœuds et les petites fissures de surface sont naturelles et n'affectent pas la solidité du produit.
- **Garderausec:** l'humidité prolongée et l'humidité élevée ou basse peuvent être défavorables pour le bois. La fissuration ou les fentes causées par les intempéries en dehors de la gamme d'humidité normale de 35 à 65% ne sont pas couvertes par notre garantie. Il est recommandé d'empêcher l'exposition prolongée à l'humidité.
- **Nettoyage:** un léger nettoyage fréquent est recommandé. Époussetez régulièrement avec un chiffon doux légèrement humide, et puis séchez (en suivant la direction du grain de bois). Pour un nettoyage plus profond, utilisez un chiffon doux et une solution de liquide de savon à vaisselle (diluer « tasse de savon lave-vaisselle doux dans 1 gallon d'eau tiède). Rincez avec de l'eau, puis séchez immédiatement les surfaces à l'aide d'un chiffon doux. N'utilisez pas de javelle, d'acide ou d'autres solvants sur aucune des pièces ou des surfaces métalliques. Les petites taches ou les rayures peuvent être légèrement polies avec de la paille de fer n° 0000, suivie d'une application d'huile de soins pour bois de bonne qualité, étendue dans le sens du grain.
- **Enduit annuel:** Il est conseillé d'entretenir chaque année les pièces en bois avec un enduit scellant ou une cire ou huile extérieure pour protéger et améliorer les surfaces en bois. Deux fois par an, après le nettoyage, appliquez sur les surfaces une huile de soins de bois de bonne qualité ou un enduit scellant à base d'eau. Les options recommandées sont le scellant extérieur à base d'eau, les graines de lin, le teck ou l'huile d'abrasin. Consultez les instructions spécifiques du fabricant pour l'application. Il est préférable d'essayer une petite section de bois, et si vous êtes satisfait du résultat, continuez l'application, en prenant soin d'éviter les surfaces métalliques.
- Pour d'autres questions ou des problèmes, veuillez contacter:
customer.care@sunjoygroup.com

Care and Maintenance

Our steel components for garden accessories and furniture are treated with rust inhibiting paint that protects it from rusting. However, due to the nature of steel, surface oxidation (rusting) will occur once these protective coatings are scratched. This is not a defect and thus not covered by the warranty.

To minimize this condition, we recommend care when assembling & handling the product to prevent scratching the paint. Should any scratching or damage occur, we recommend immediate touch-up with rust inhibiting paint.

Surface rust can also be easily removed with a very light application of common cooking oil. If surface oxidation (rusting) occurs and if no measure is taken to prevent this, the oxidation may start dripping on to deck or patio and caused damaging stains, which may be difficult to remove. This can be prevented if the above-mentioned measures are taken to keep the product from oxidizing.

Use damp cloth to wipe off the stains as quickly as possible.

If necessary, wash with a mild solution of soap and water; rinse thoroughly and dry completely.

Periodically check and ensure that all bolts are well-tighten during use

Limited Manufacturer's Warranty

Sunjoy Group warrants to the original purchaser that this item is free from defects in workmanship and materials for a period of **1 year** from the date of purchase, provided the item was factory-sealed at the time of purchase and is maintained with care and used only for personal, residential purposes. Should any manufacturing defect arise within this warranty period, Sunjoy Group will replace (at our option) any defective merchandise or parts upon proof of purchase; however, transportation and delivery costs, as well as payments to a third party for assembly or disassembly of the item, remain the responsibility of the purchaser. A purchaser of an "open box," previously-returned, or "clearance" item, as well as original purchasers outside of the warranty period, may obtain replacement parts from Sunjoy Group for products in current production, at nominal cost.

Exclusions

Items used for commercial, contract, or other non-residential purposes, or items damaged due to acts of nature, vandalism, misuse, or improper assembly are not covered. Corrosion or rusting of hardware is not covered. Proof of purchase (dated register receipt) is required for warranty claims. Warranty is to the original purchaser and is non-transferable. Any replacement of warranted items will be in the original style and color, or a similar style and color if the original is unavailable or has been discontinued. As some states do not allow exclusions or limitations on an implied warranty, the above exclusions and limitations may not apply. This warranty gives you specific rights, and you may also have other rights, which vary from state to state.

Care and Maintenance

Les composants en acier de nos meubles et accessoires de jardin sont traités avec une peinture antirouille qui les protège. Toutefois, en raison de la nature de l'acier, une oxydation de la surface (rouille) se produira si ces revêtements protecteurs sont égratignés. La garantie ne couvre pas ce phénomène puisqu'il ne s'agit pas d'un défaut.

Afin de minimiser cette situation, nous recommandons d'être prudent lors de l'assemblage et de la manipulation du produit afin d'éviter d'égratigner la peinture. En cas d'égratignure ou de dommage, nous recommandons d'effectuer immédiatement une retouche avec une peinture antirouille.

La rouille de surface peut facilement être retirée à l'aide d'une petite quantité d'huile de cuisson. Si une oxydation (rouille) de la surface se produit et qu'aucune mesure n'est prise pour corriger la situation, la rouille pourrait couler sur la terrasse et causer des taches dommageables qui peuvent être difficiles à enlever. Cela peut être évité si les mesures mentionnées ci-dessus sont prises pour empêcher l'oxydation du produit.

Utilisez un linge humide pour essuyer les taches le plus rapidement possible.

Au besoin, nettoyez le produit avec une solution d'eau et de savon doux, rincez-le abondamment et séchez-le complètement.

Vérifiez périodiquement pour vous assurer que tous les écrous sont bien serrés pendant l'utilisation.

Garantie limitée du fabricant

Sunjoy Group garantit à l'acheteur initial que ce produit ne présentera aucun défaut de fabrication et de matériaux pendant une période de un an à compter de la date de l'achat si le produit a été acheté dans son emballage scellé à l'usine, et s'il a été entretenu correctement et utilisé à des fins personnelles et résidentielles seulement. Si le produit présente un défaut de fabrication pendant cette période de garantie, Sunjoy Group remplacera (à sa discrétion) toute marchandise ou pièce défectueuse sur présentation d'une preuve d'achat. Toutefois, les frais de transport et de manutention, ainsi que les paiements versés à un tiers pour l'assemblage ou le démontage du produit, demeurent la responsabilité de l'acheteur. Les acheteurs de produits avec « boîte ouverte », précédemment retournés ou « en liquidation », ainsi que les acheteurs initiaux de produits dont la période de garantie est terminée, peuvent obtenir des pièces de rechange auprès de Sunjoy Group pour des produits actuellement en production, à peu de frais.

Exclusions:

Les articles utilisés à des fins commerciales, locatives ou non résidentielles et les articles endommagés par des phénomènes naturels, des actes de vandalisme, un usage inapproprié ou un assemblage inadéquat ne sont pas couverts. La corrosion et la rouille de la quincaillerie ne sont pas couvertes. Une preuve d'achat (une copie de votre reçu daté) doit être présentée avec toute réclamation au titre de la garantie. La garantie n'est accordée qu'à l'acheteur initial et est non transférable. Si l'article original n'est plus offert, il sera remplacé par un article d'une couleur et d'un style similaires. Certains États ou certaines provinces ne permettent pas l'exclusion ou la limitation d'une garantie implicite, de sorte que les limitations et exclusions mentionnées ci-dessus peuvent ne pas s'appliquer à vous. Cette garantie vous confère des droits précis. Il est possible que vous disposiez également d'autres droits, qui varient d'un État ou d'une province à l'autre.