

**ASSEMBLY INSTRUCTION**  
**ITEM#: A102007602**

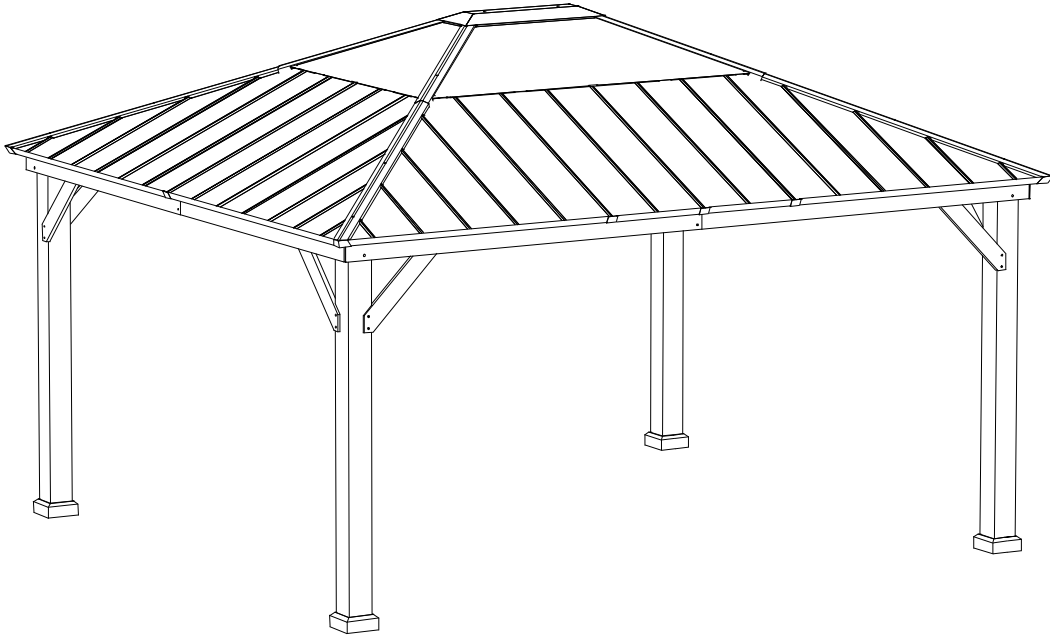

**WE HAVE YOU IN MIND, LET US SERVE YOU!**

Questions? Issues?

**CONTACT US**

24 hours / 7 days a week

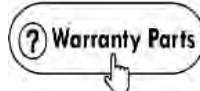

[www.sunjoyonline.com](http://www.sunjoyonline.com)



[customer.care@sunjoygroup.com](mailto:customer.care@sunjoygroup.com)



A10200761122

## Important Safety Instructions



**Warning!** To reduce the risk of serious injury, read the following safety instructions before assembling and using the gazebo.

Please check with your local governing authority/local municipal codes regarding installation of structures before assembly.

**Caution!** Proper placement of your gazebo is essential.

Do not place the product underneath electrical lines.

Keep children away during assembly.

This product contains small parts which can be swallowed by children.

Keep fingers away from the places where they can be pinched or trapped. Do not attempt to assemble the gazebo if any parts are missing.

- This product is intended for domestic outdoor use only.
- The product should be placed on flat, horizontal ground.
- Ensure enough clearance around the product. Before assembling the product, find level ground not less than 6' (1.8 m) away from any structures or obstructions, such as fences, garages, houses, overhanging branches, laundry lines, or electrical wires.
- This gazebo is not to be regarded as part of a building/house structure. The gazebo is to be anchored onto the ground for added safety. Do not assemble the gazebo onto soil/earth ground. It is best advisable to have the gazebo built onto a wooden deck or concrete ground for stability. If it is to be build onto a wooden deck/ground, do ensure that the wooden deck/ground has a strong foundation. It is advisable to use appropriate floor plugs (not provided) to anchor the gazebo onto the wooden/concrete ground.
- Some structures may require two or more people to install safely. Check for underground utilities before digging or driving stakes into the ground.
- During installation, follow all safety warnings provided with your tools, and use safety glasses.
- In case you set up more than one gazebo, keep a minimum distance of 10' (3 m) between the gazebos.
- Any assembly or maintenance of the product must be carried out by adults only.
- Arrange necessary manpower when assembling or moving the product.
- Some parts may contain sharp edges. Wear protective gloves if necessary.
- Keep children and pets away while setting up the gazebo.
- Check all nuts and bolts periodically to ensure bolts/nuts are tightened.
- Repairing and replacing parts should be done by a qualified technician.
- This gazebo is intended for decorative and sunshade purposes only, and it is not designed to withstand harsh weather, including high winds, rain, and snow.
- Do not light any fires inside or near the product!
- Stay calm if fire breaks out. Search for the nearest exit. Do not return to the gazebo before firemen allow you to do so.
- Do not hang heavy weights on the roof frame.
- Do not climb onto the roof of the gazebo. Falling off the gazebo can result in serious injury.
- Retain the original packaging to store the gazebo.

**Country of Origin: China**

**IMPORTANT:**

- Please read and understand this manual before any assembly. Before beginning assembly of product, make sure all parts are present. Compare parts with packaging contents list.
- **When assembling wooden parts, do not overtorque the bolts to avoid splitting the wood. See image illustration.**
- Place all parts from the box in a cleared area and position them on the floor in front of you.
- Remove all packing materials and place them back into the box. Do not dispose of the packing materials until assembly is complete.
- Needed for assembly: (The following tools are not included)

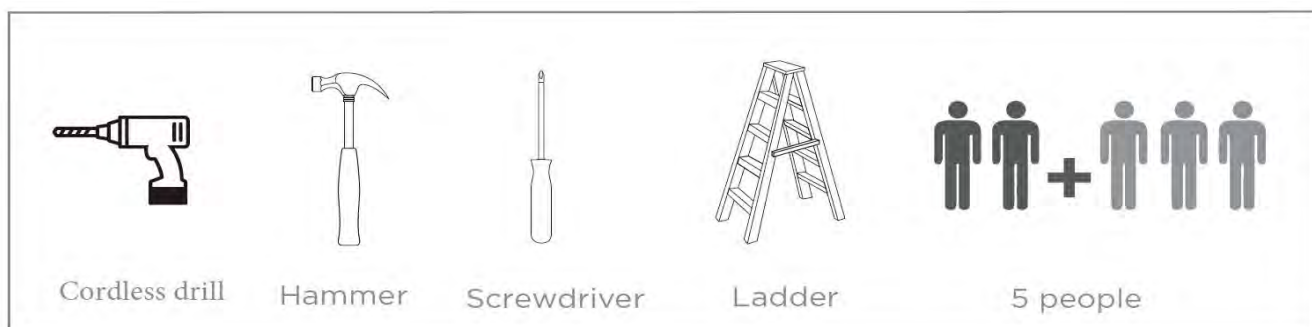

This identifies information that requires special attention. Improper assembly could lead to an unsafe or dangerous condition.

**Use Level**

Check that set or assembly is properly level before proceeding.

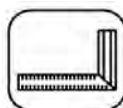
**Square Assembly**

Check that assembly is square before tightening bolts.

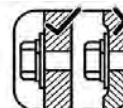
**Tighten Bolts**







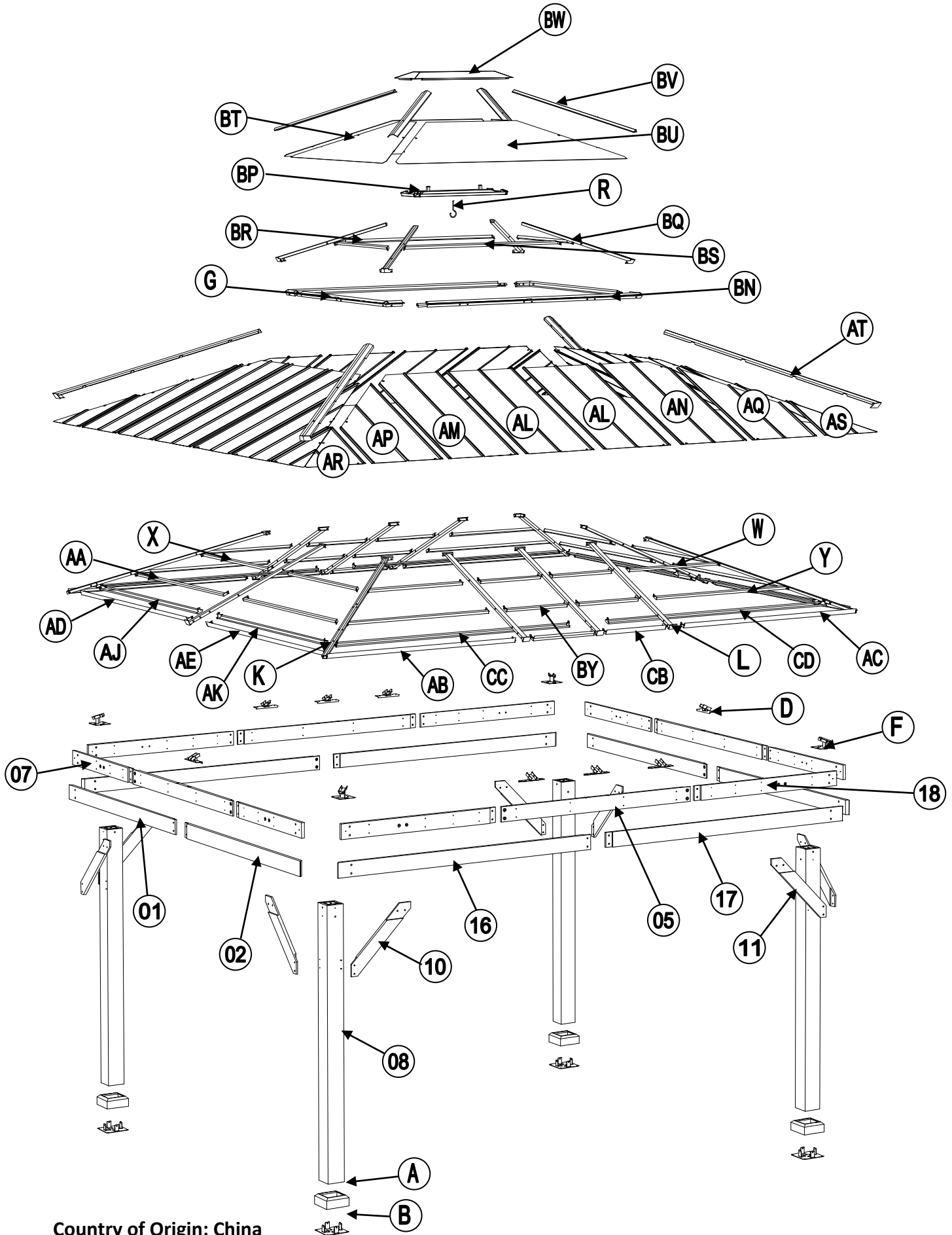



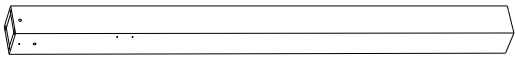

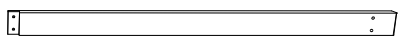



Do not overtighten mounting bolts. Overtightening may cause the wood to crack creating splinters and other structural damage.

**Measure Distance**



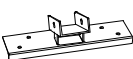







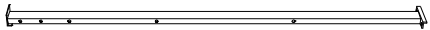
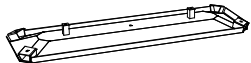

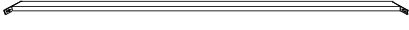

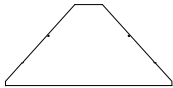
# EXPLODED DRAWING



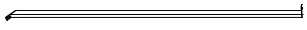

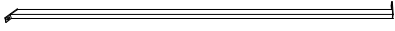





Country of Origin: China

Parts List				
Label	Part Number	Description	Qty	Part Image
08	P000200227	Post	4	
01	P000400506	Outer Left Long Beam	2	
02	P000400507	Outer Right Short Beam	2	
16	P000400946	Outer Long Left Beam	2	
17	P000400947	Outer Short Right Beam	2	
05	P000400510	Inner Long Beam	4	
07	P000400511	Inner Short Beam (Short)	4	
18	P000400948	Inner Long Beam (Long)	4	
10	P005000200	Arc Support 1	4	
11	P005000201	Arc Support 2	4	
A	P00610021602	Base Cover	4	
B	P00010025802	Base	4	
D	P00050025102	Middle Beam Connector	8	
F	P00050024802	Slanting Beam Connector	4	
G	P00050157002	Big Roof Short Connector Tube	2	
BN	P00050157102	Big Roof Long Connector Tube	2	
K	P00060197102	Big Roof Slanting Beam	4	

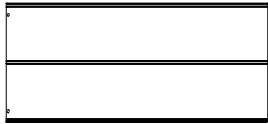

Country of Origin: China

L	P00060198302	Big Roof Middle Beam	8	
BP	P00050156602	Small Roof Connector	1	
BQ	P00060195802	Small Roof Oblique Beam	4	
BR	P00060196302	Small Roof Top Beam(Short Side)	2	
BS	P00060196602	Small Roof Top Beam(Long Side)	2	
R	P005800001	Hook	1	
BT	P00070094601	Small Roof Panel(Short Side)	2	
BU	P00070094801	Small Roof Panel(Long Side)	2	
BV	P00080033302	Small Roof Slanting Beam Cover	4	
BW	P00090015602	Top Cover	1	
X	P00060199003	Big Roof Top Beam(Upper)	4	
W	P00060198902	Big Roof Top Beam(Upper)	4	
BY	P00060200903	Small Roof Middle Top Beam(Oversize Long Side)	8	
AA	P00060200003	Short Roof Top Beam(Middle)	4	
Y	P00060199902	Big Roof Top Beam(Middle)	4	
AD	P00060201303	Big Roof Panel Flashing(Short Side Left)	2	
AE	P00060201702	Big Roof Panel Flashing(Short Side Right)	2	
AB	P00060201202	Big Roof Panel Flashing(Long Side Left)	2	

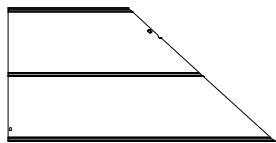
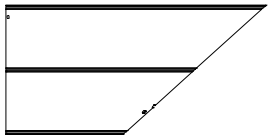
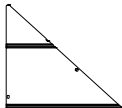
Country of Origin: China

AC	P00060201603	Big Roof Panel Flashing(Long Side Right)	2	
CB	P00060201803	Big Roof Middle Panel Flashing(Oversiez Side)	4	
AJ	P00570034703	Left Mosquito Netting Rod	2	
AK	P00570034803	Right Mosquito Netting Rod	2	
CC	P00570034903	Left Mosquito Netting Rod (Ocersize Long Side)	2	
CD	P00570035003	Right Mosquito Netting Rod (Oversize Long Side)	2	
AL	P00070103503	Big Roof Middle Panel	6	
AM	P00070102102	Big Roof Big Panel (Left)	4	
AN	P00070102602	Big Roof Big Panel (Right)	4	
AP	P00070101402	Big Roof Small Panel (Left Middle)	4	
AQ	P00070101602	Big Roof Small Panel (Right Middle)	4	
AR	P00070101002	Big Roof Small Panel (Left)	4	

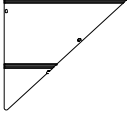

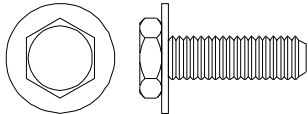
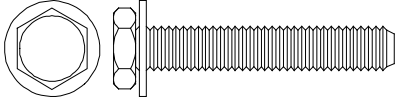
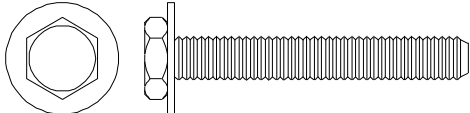
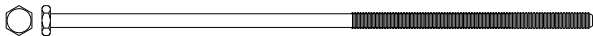
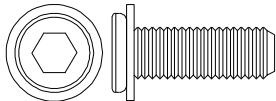
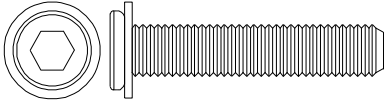
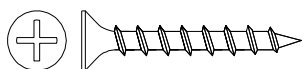
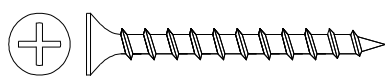
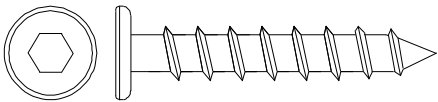
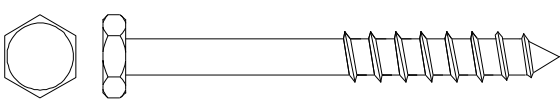
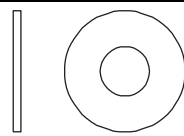
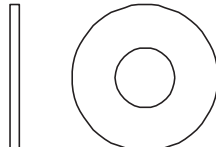
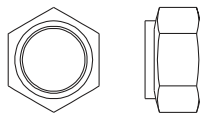

Country of Origin: China

AS	P00070101202	Big Roof Small Panel (Right)	4	
AT	P00080034403	Big Roof Inclined Beam Cap	4	

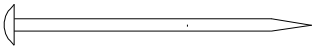
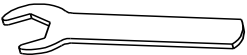

Hardware Pack					
Label	Part Number	Description	Qty	Add	Part Image
H1	H100010047	Bolt M6*20	222	14	
H2	H100010069	Bolt M6*35	4	1	
H3	H100010059	Bolt M6*45	8	1	
H4	H010010449	Bolt M10*205	8	1	
H5	H100010054	Bolt M8*25	24	2	
H6	H100010055	Bolt M8*35	16	1	
H7	H030050058	Screw ST4.8*30	80	4	
H8	H030050057	Screw ST4.8*40	96	5	
H9	H030030013	Screw ST8*35	16	1	
H10	H030010031	Screw ST9.5*80	8	1	
H11	H050030002	Flat Washer M8	16	1	
H12	H050030003	Flat Washer M10	24	2	
H13	H040050026	Non-slip Nuts M10	8	1	

Country of Origin: China

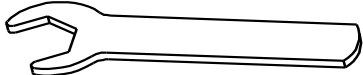
H14	H040090004	T-Nut M8*8	24	2	
H15	H040090005	T-Nut M8*20	16	1	
H16	H090990002	M3 Drill	2	0	
HS	H070010003	Stake Φ8*180	8	0	
HW1	H090010017	M6 Wrench	2	0	
HW2	H090030005	Allen Key M8	1	0	
HW3	H090010015	M10 Wrench	2	0	

# 1

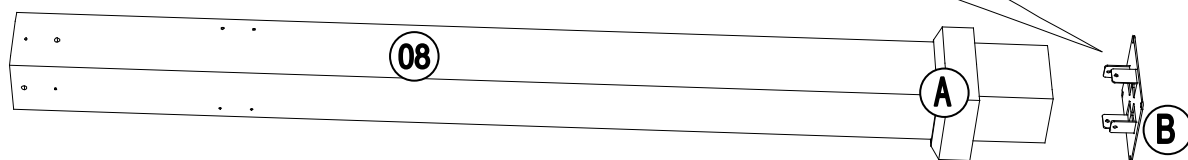
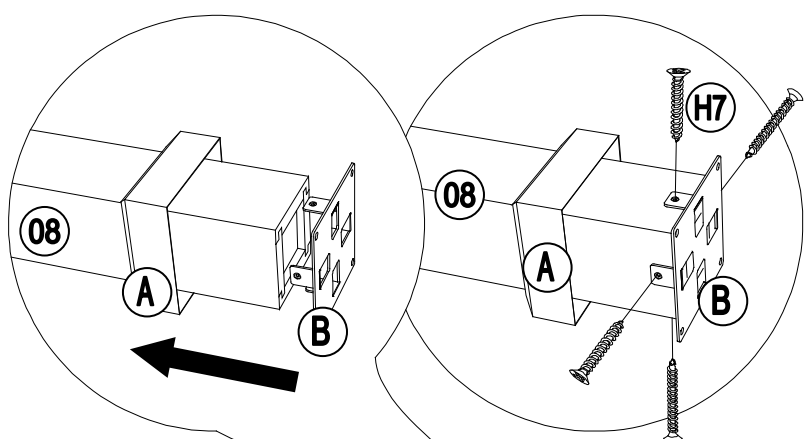
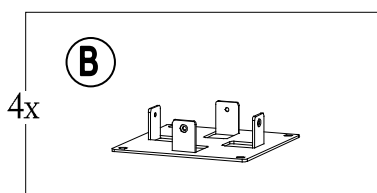
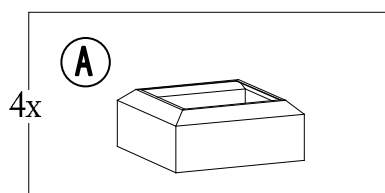
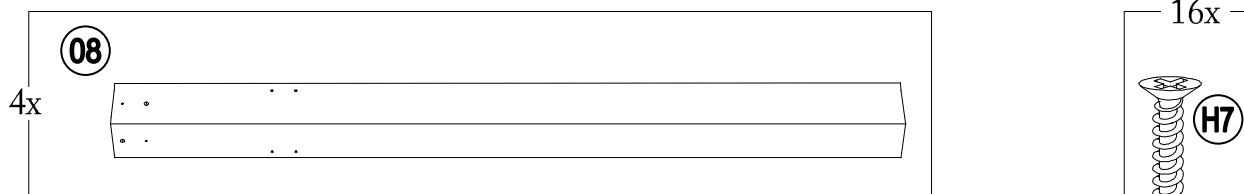

# 2

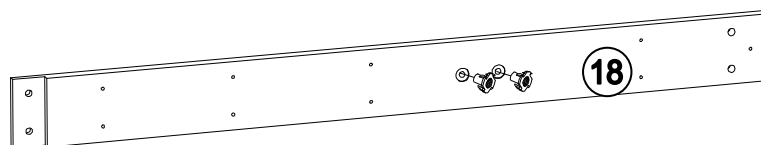
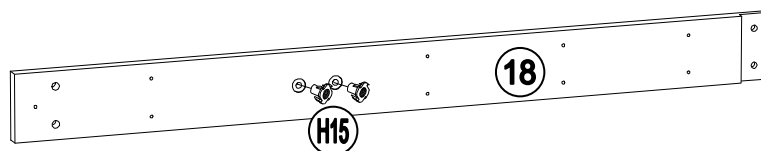
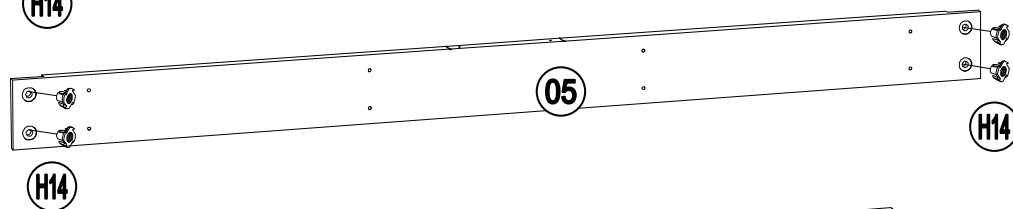
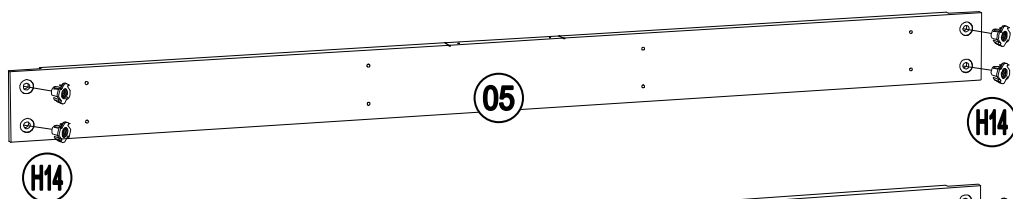
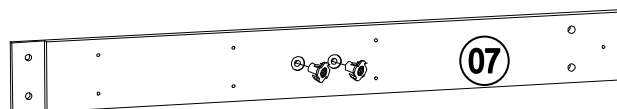
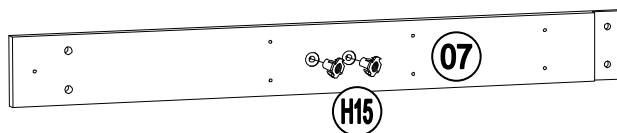
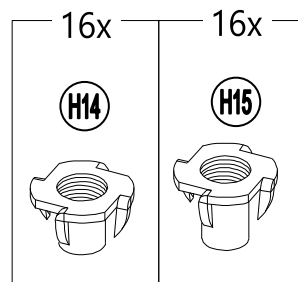
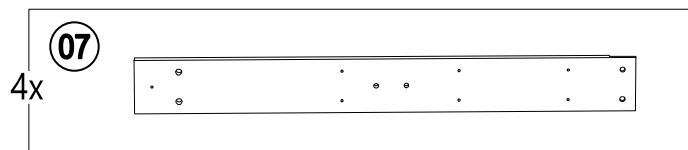
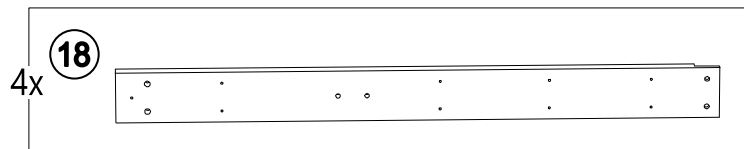
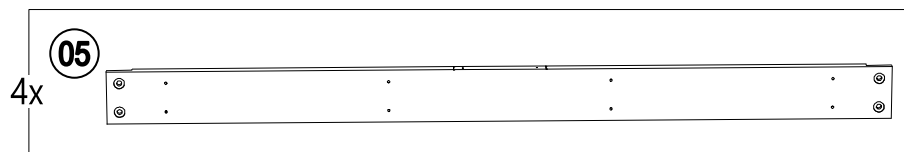

3

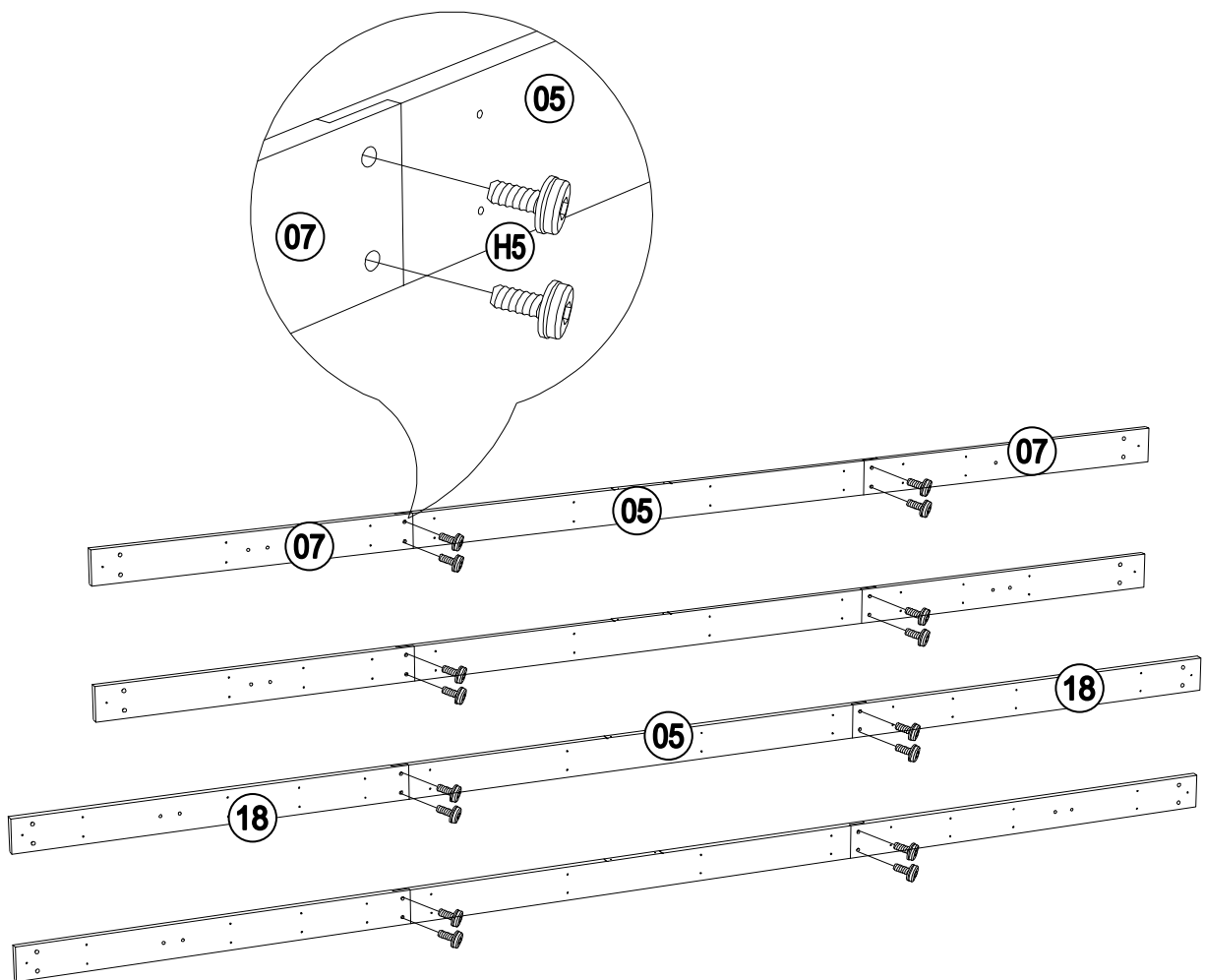
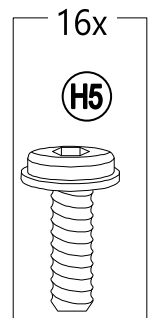

# 4

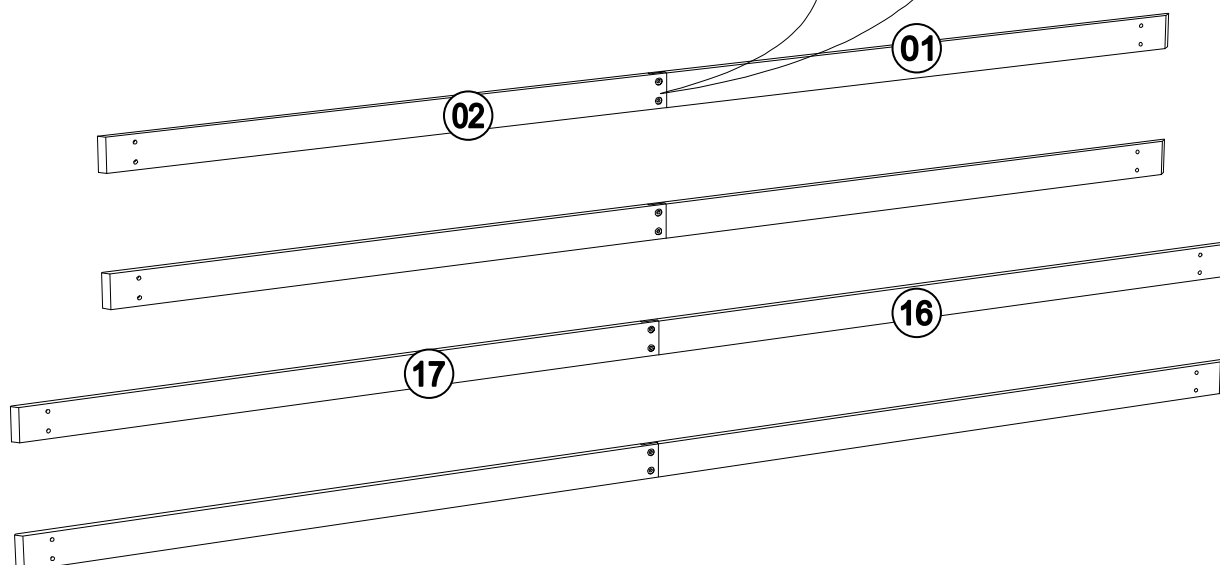
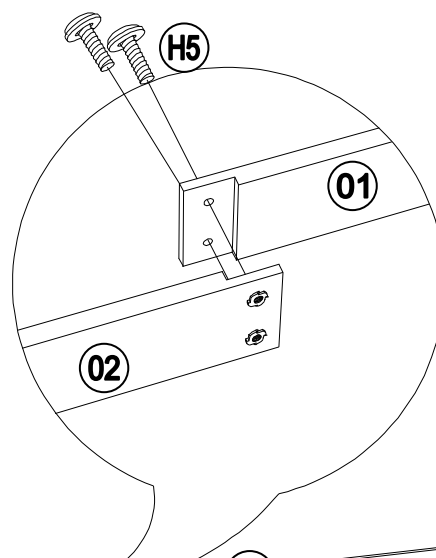
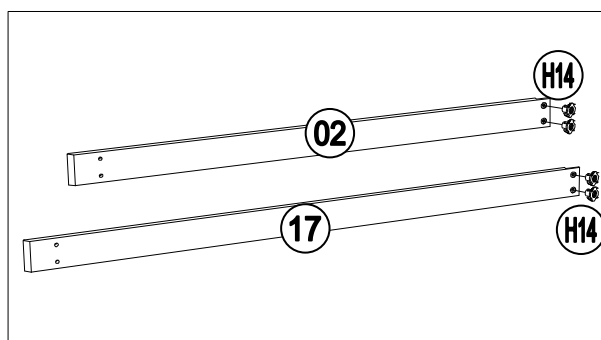
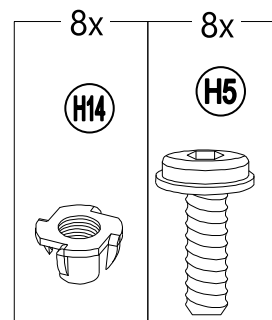
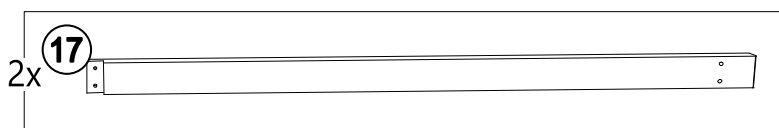
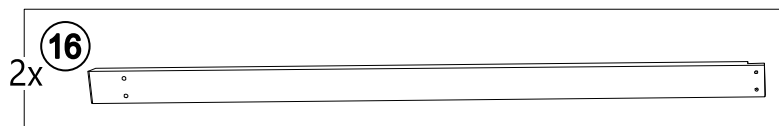
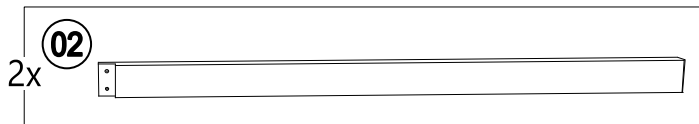
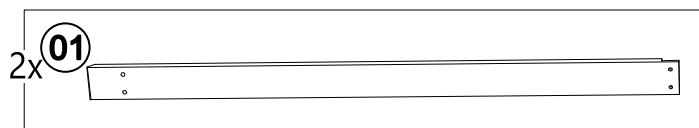

# 5

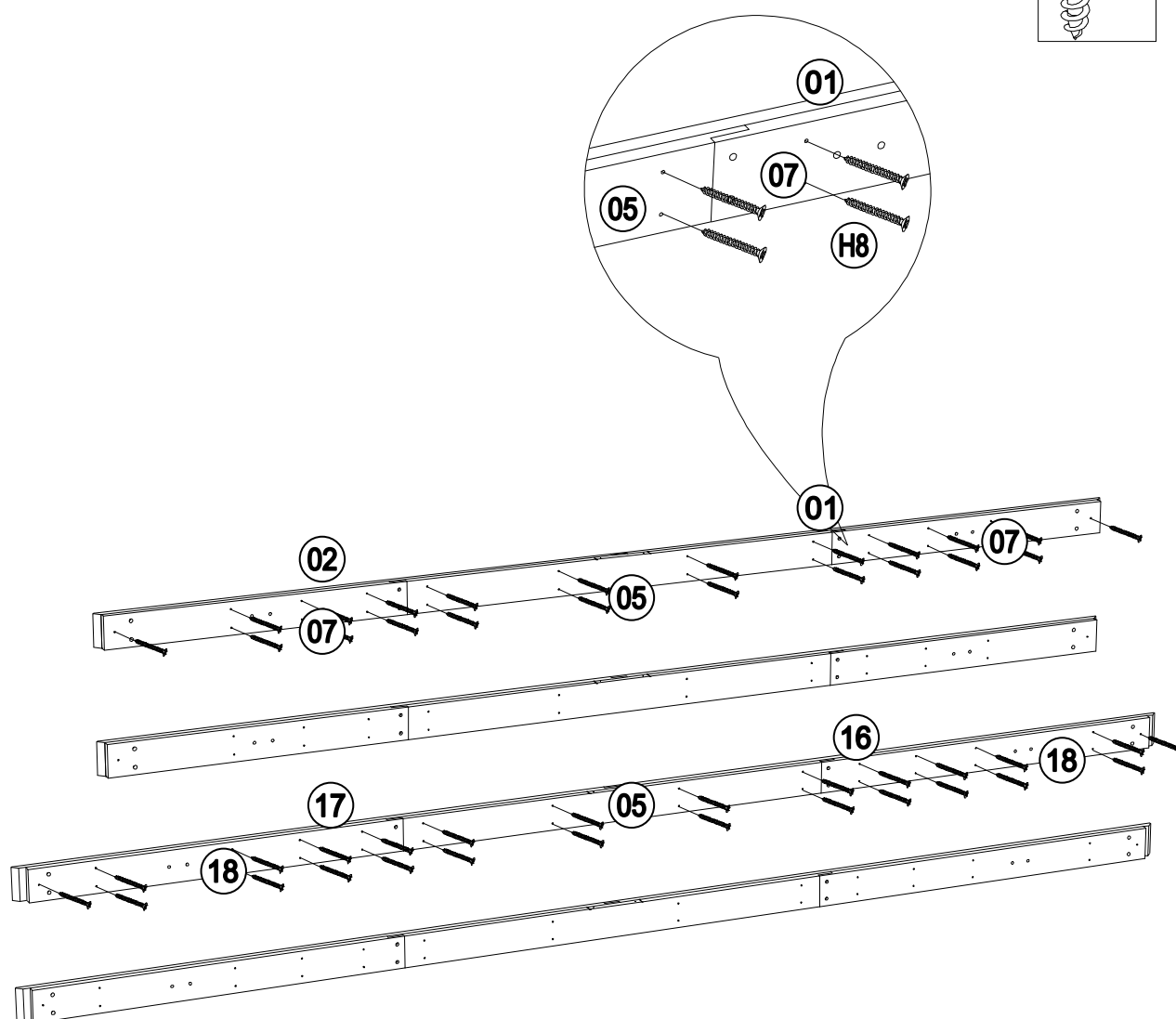
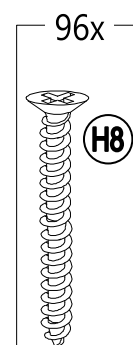

# 6

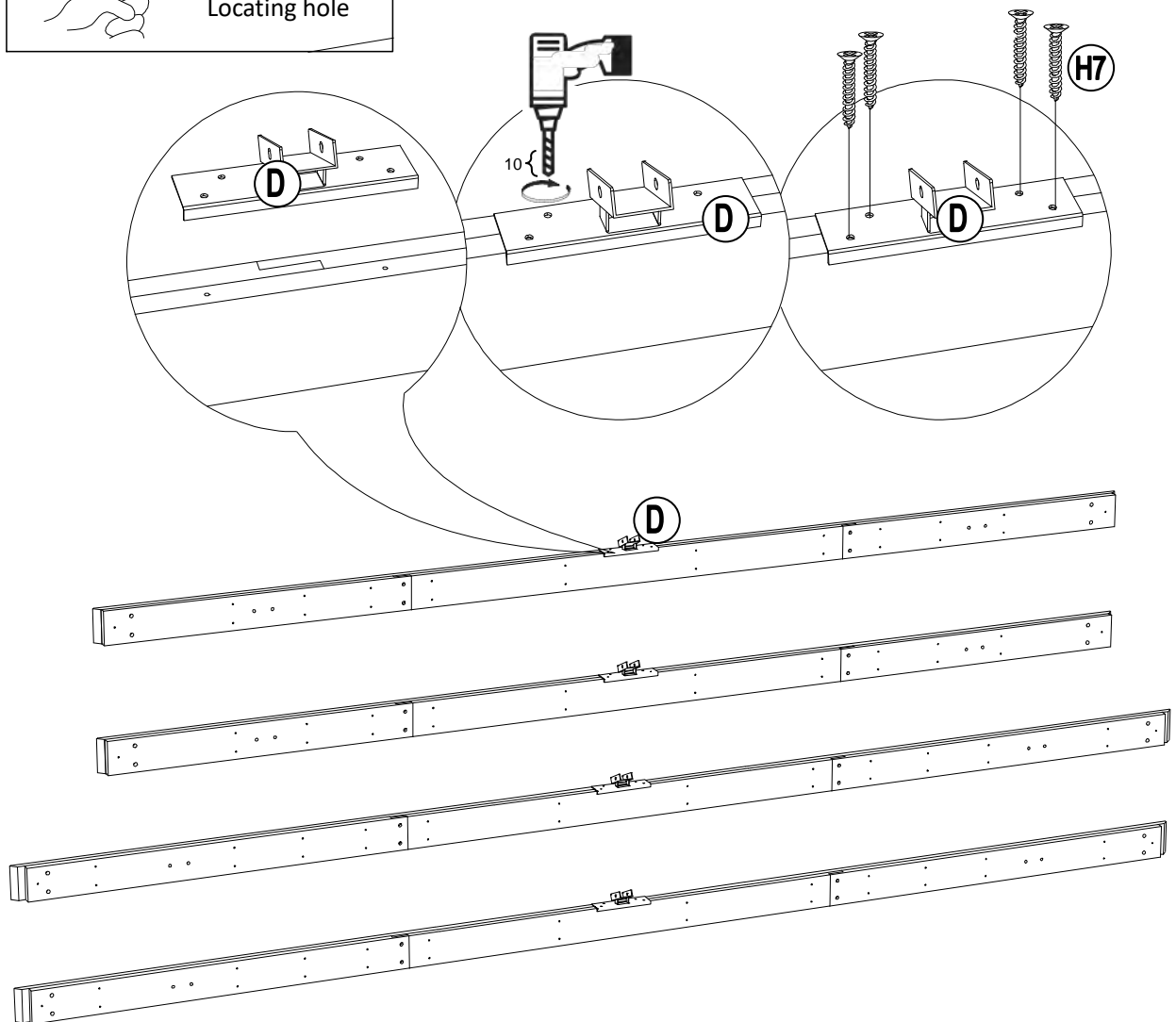
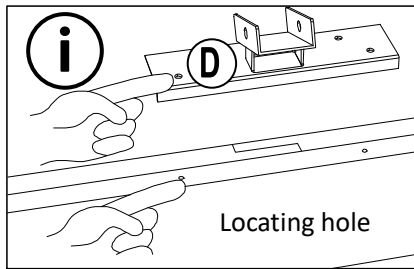
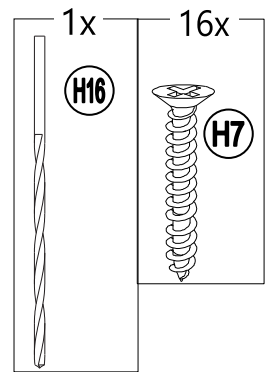
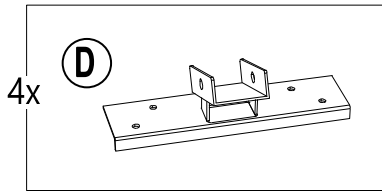



7

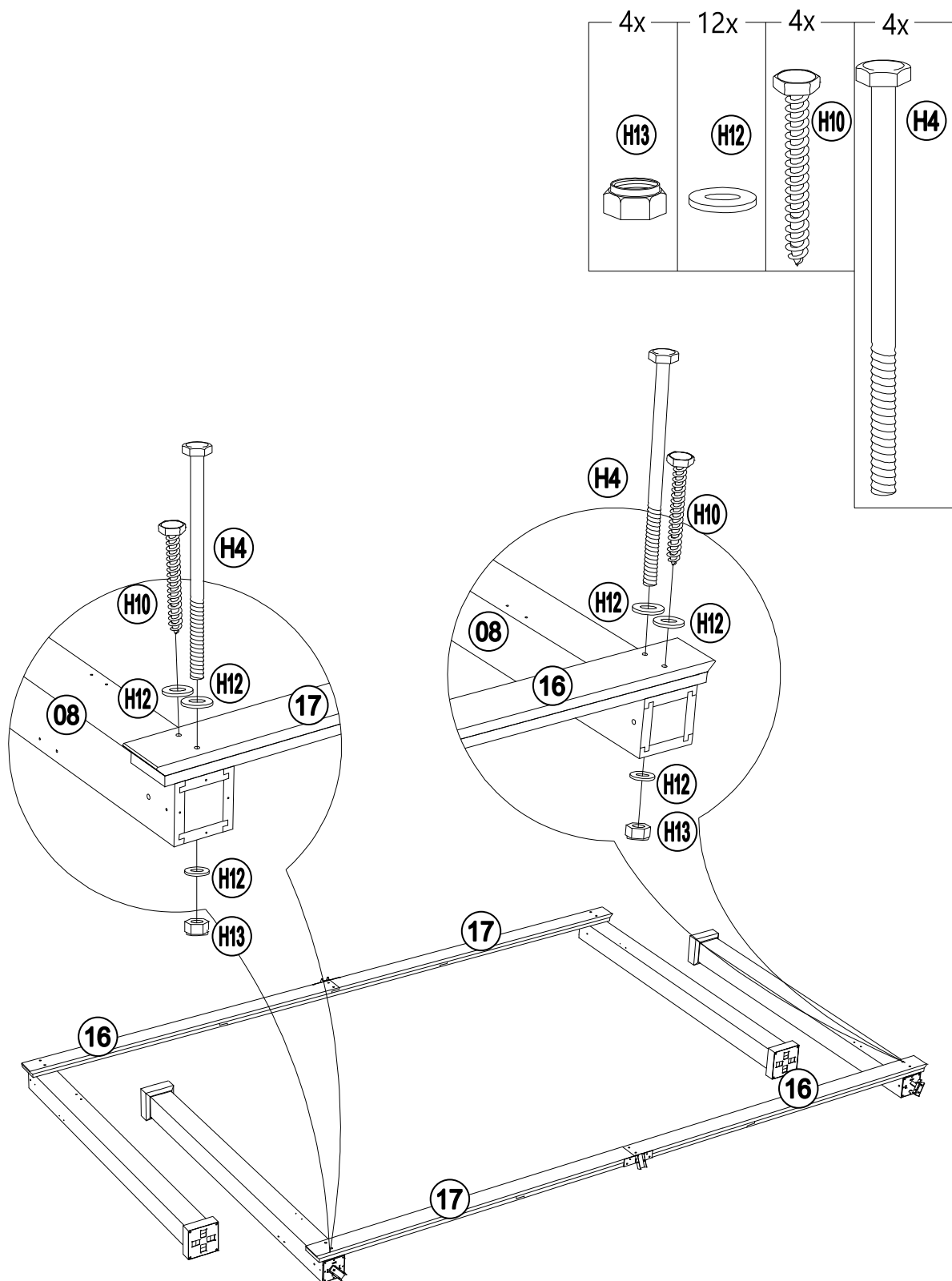

# 8

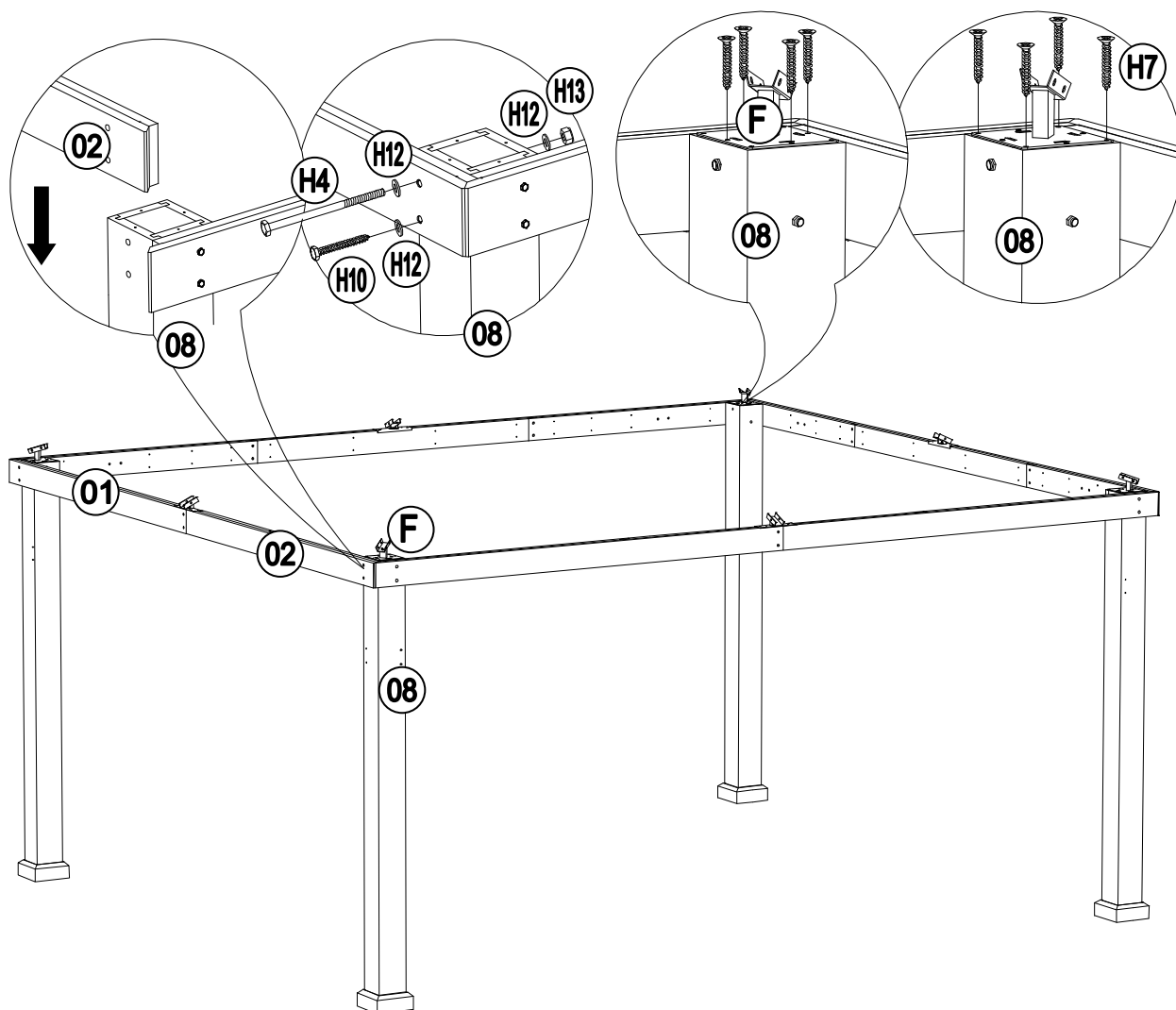
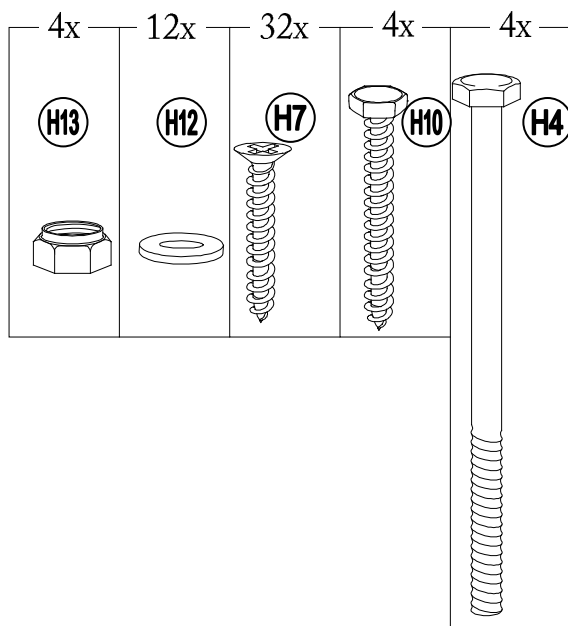
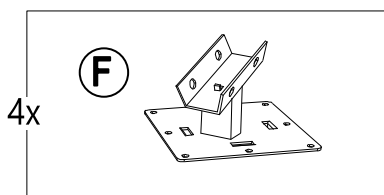

9

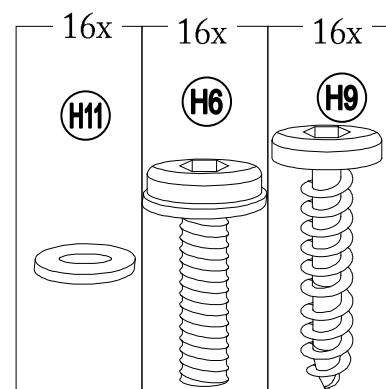
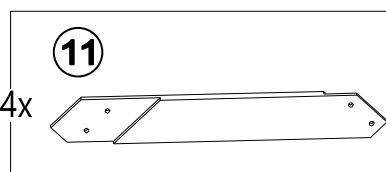
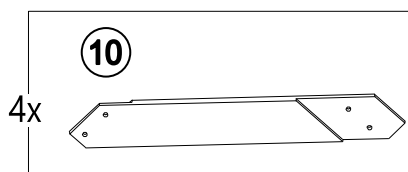

**i**  $d1=d2$

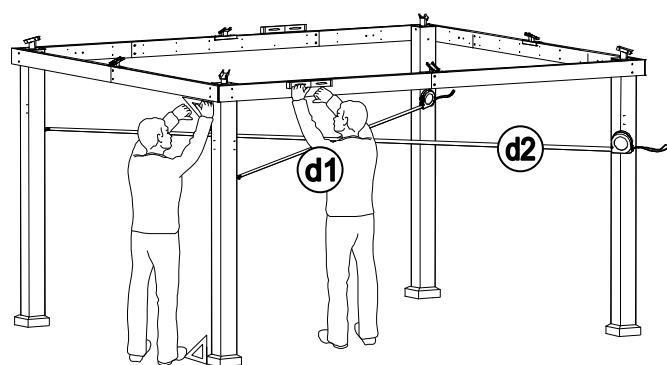

Rt  $\angle 90$

**Assembly Tip on Step 8:**

Please measure to make sure the length of d1 is equal to d2 before moving to next step to ensure a square frame and best results. Keep the beam at right angles to the post, the post at right angles to the ground, and keep the beam horizontal.

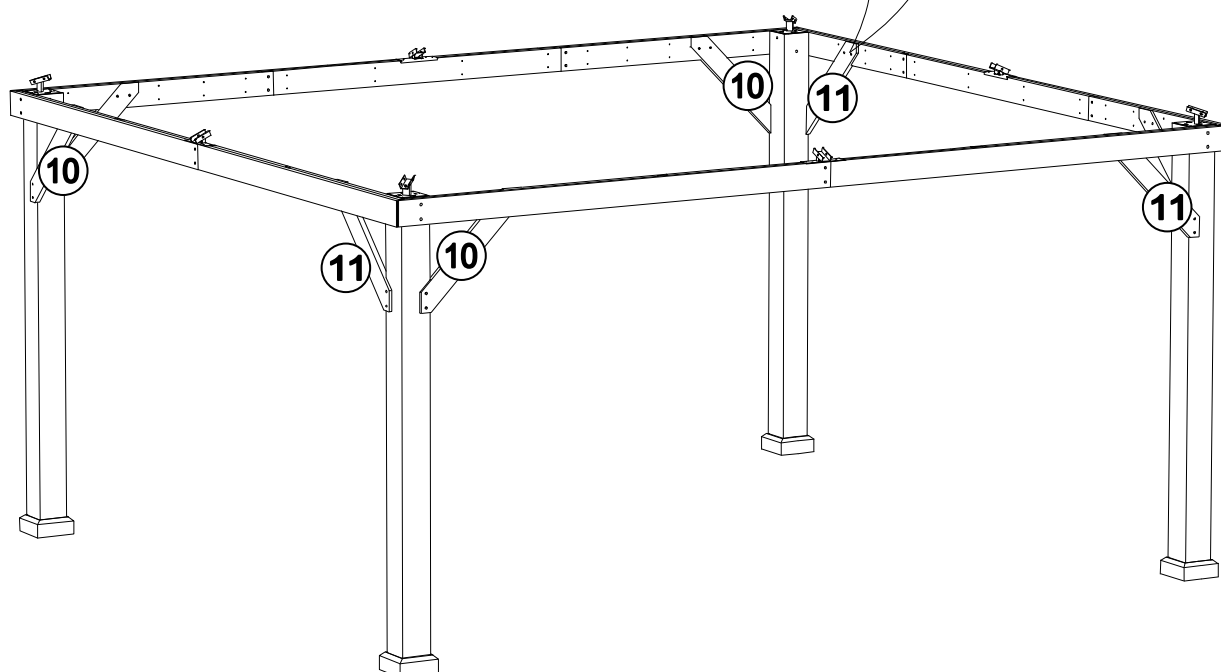
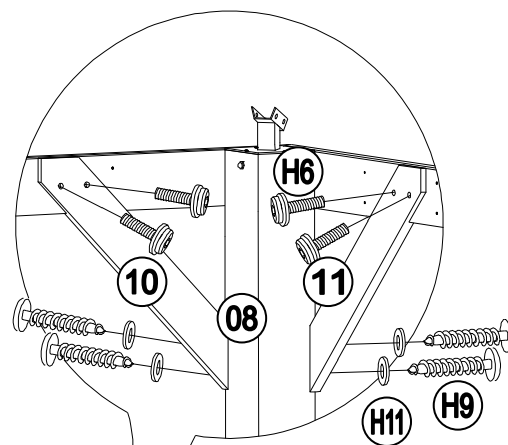

# 10

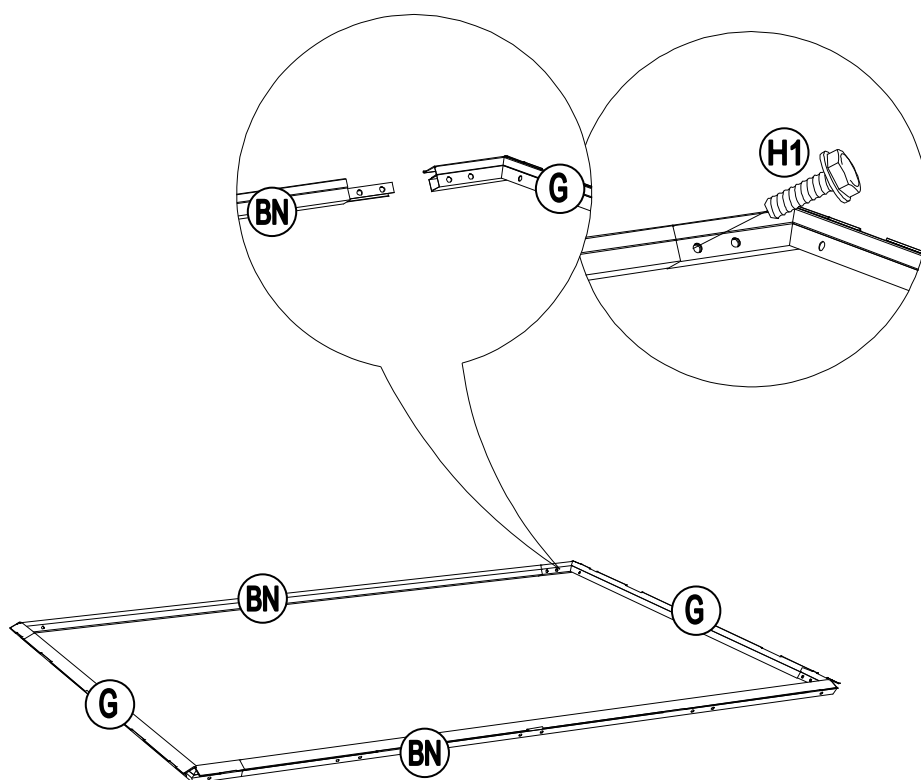
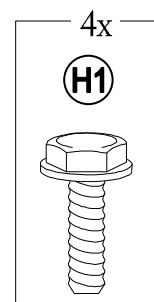
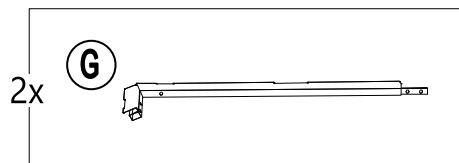
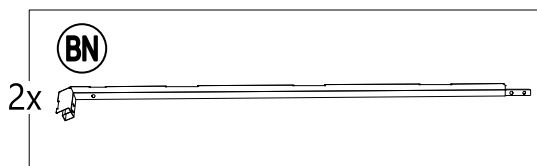

# 11

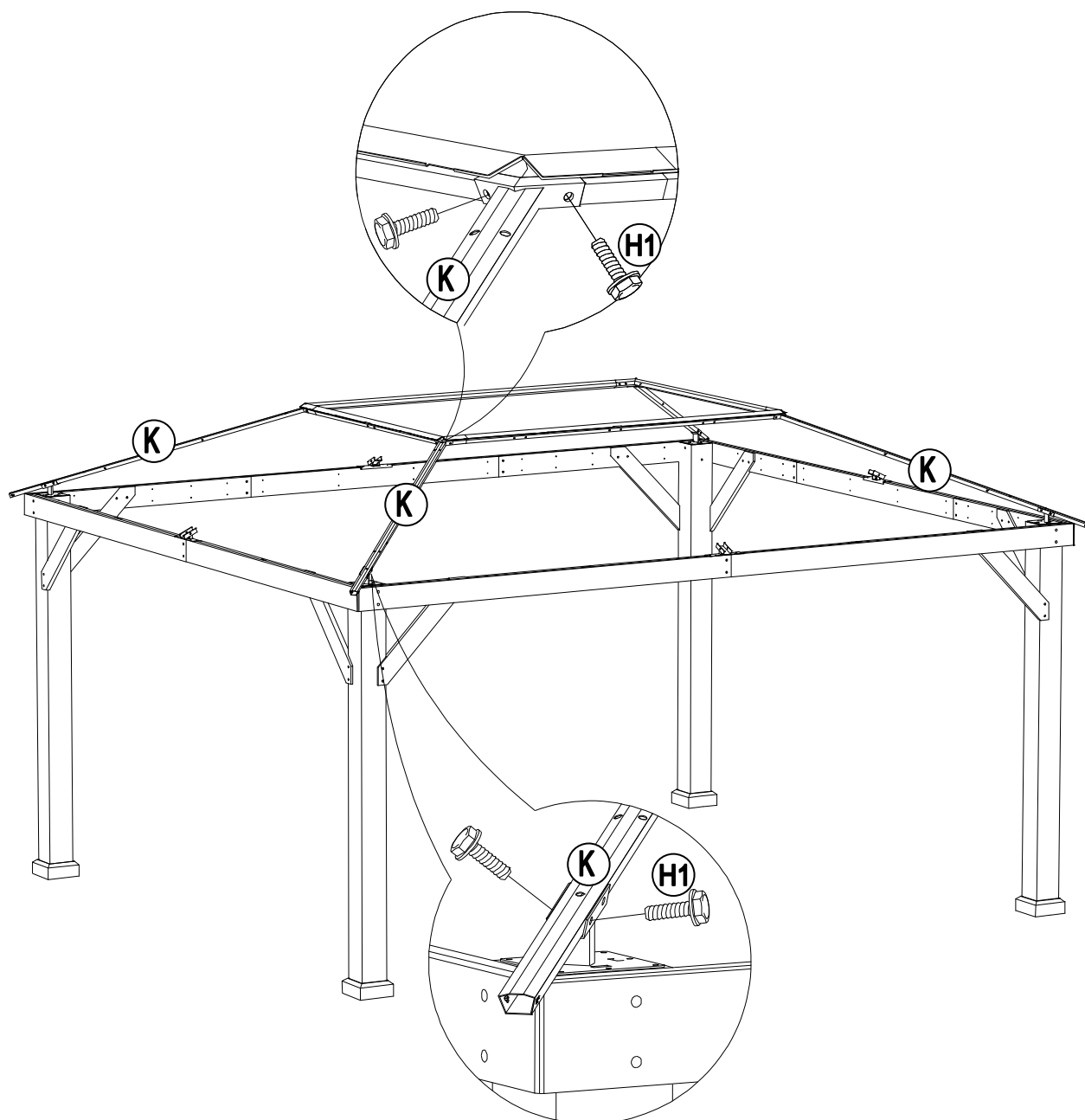
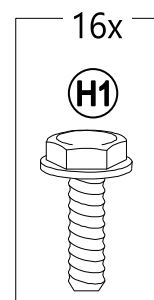
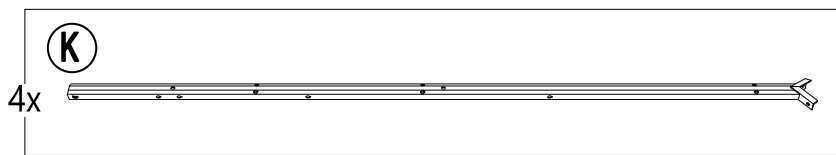

Country of Origin: China

# 12

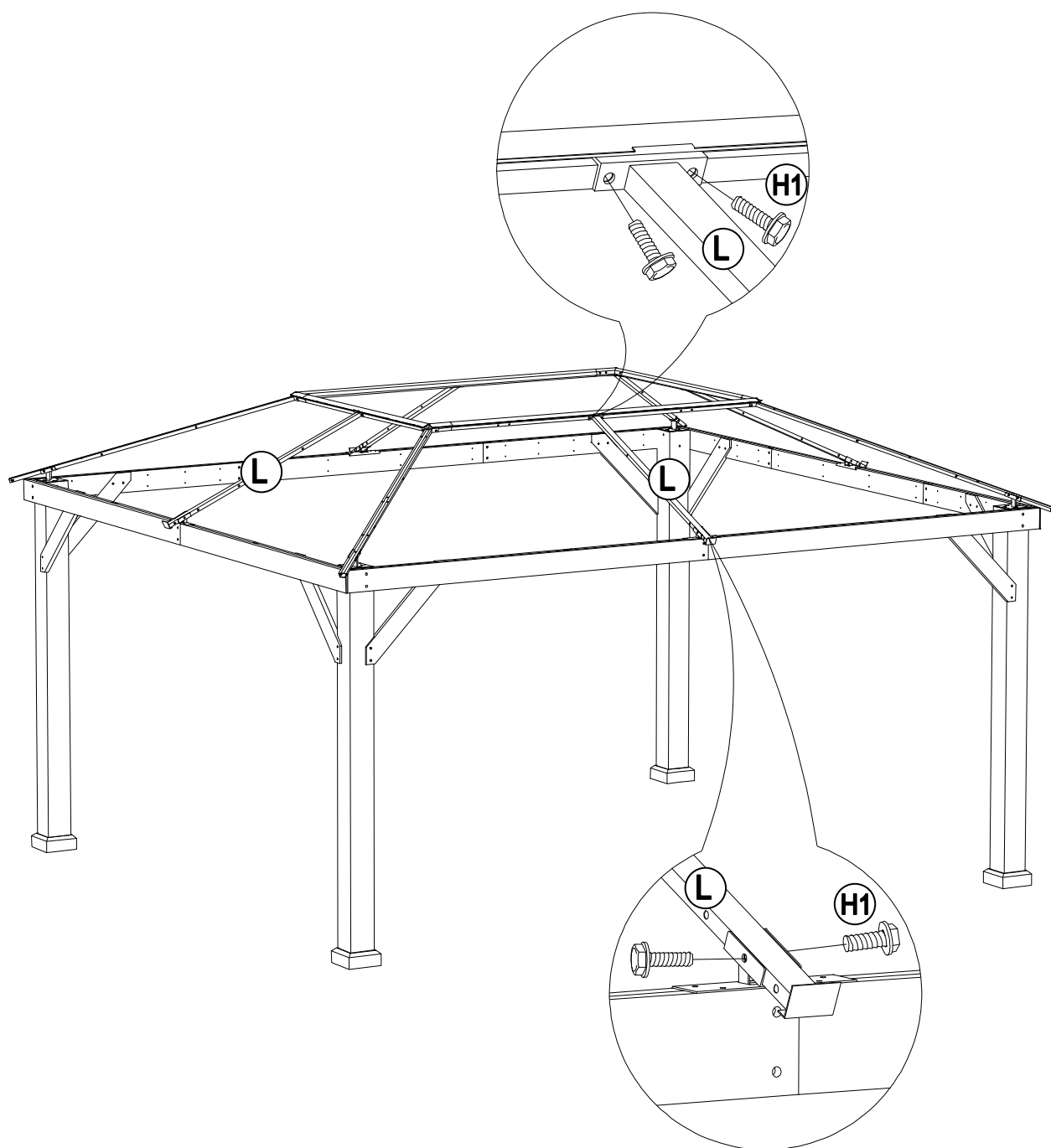
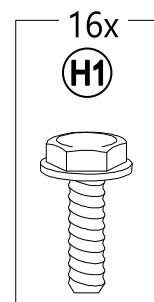
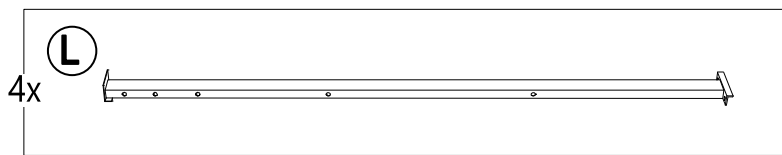

## 13

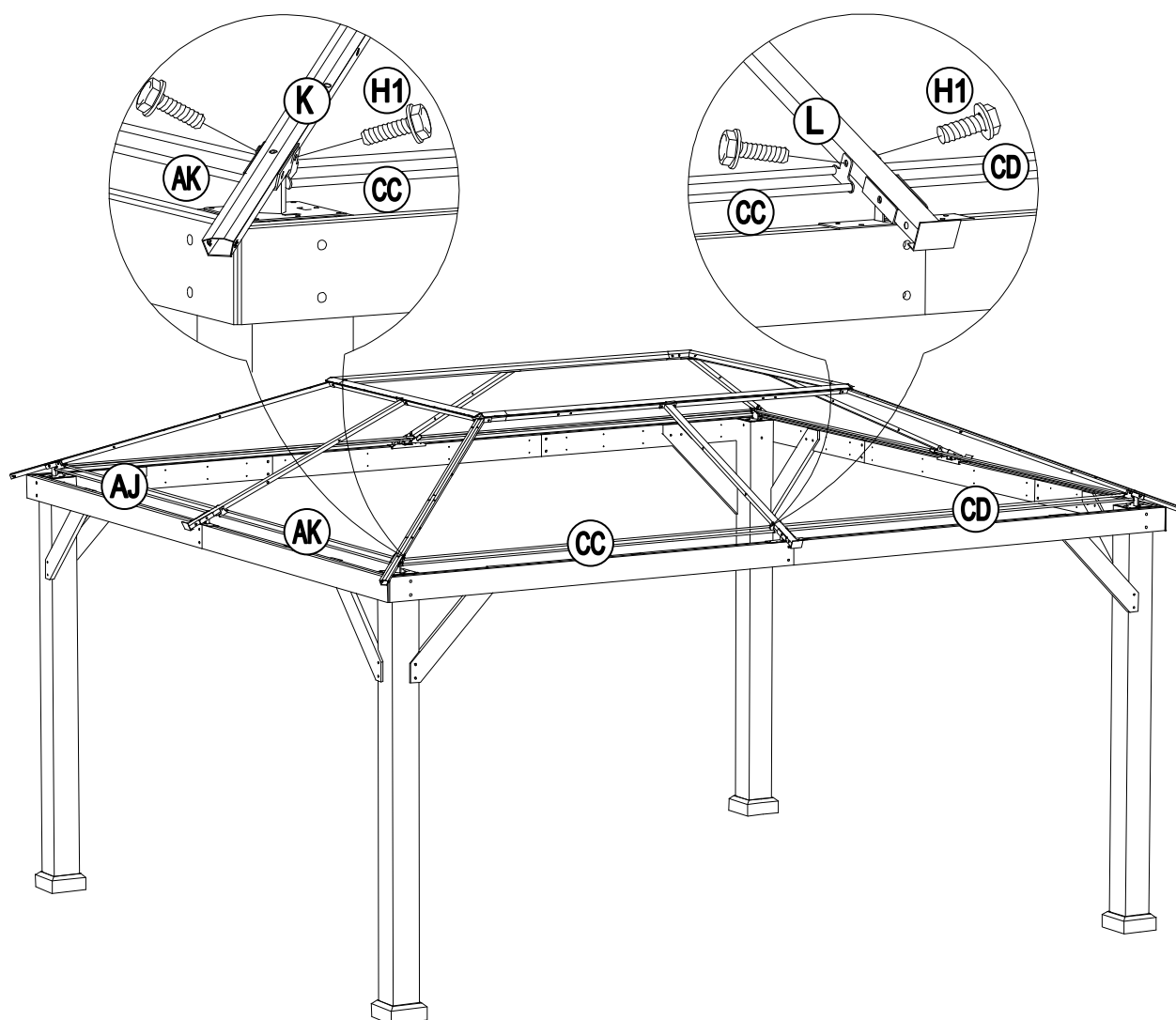
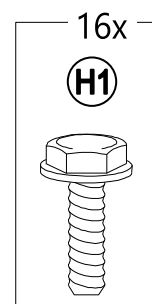
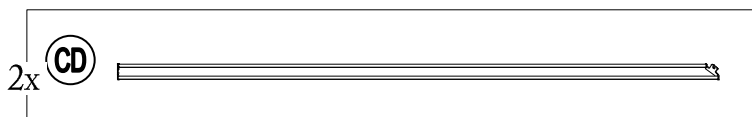
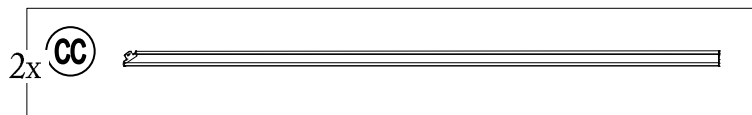
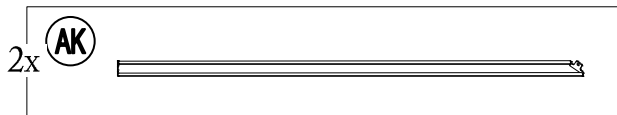
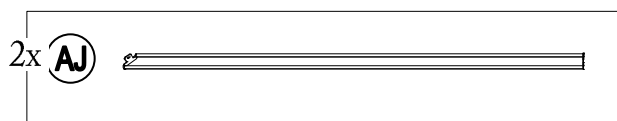

Country of Origin: China

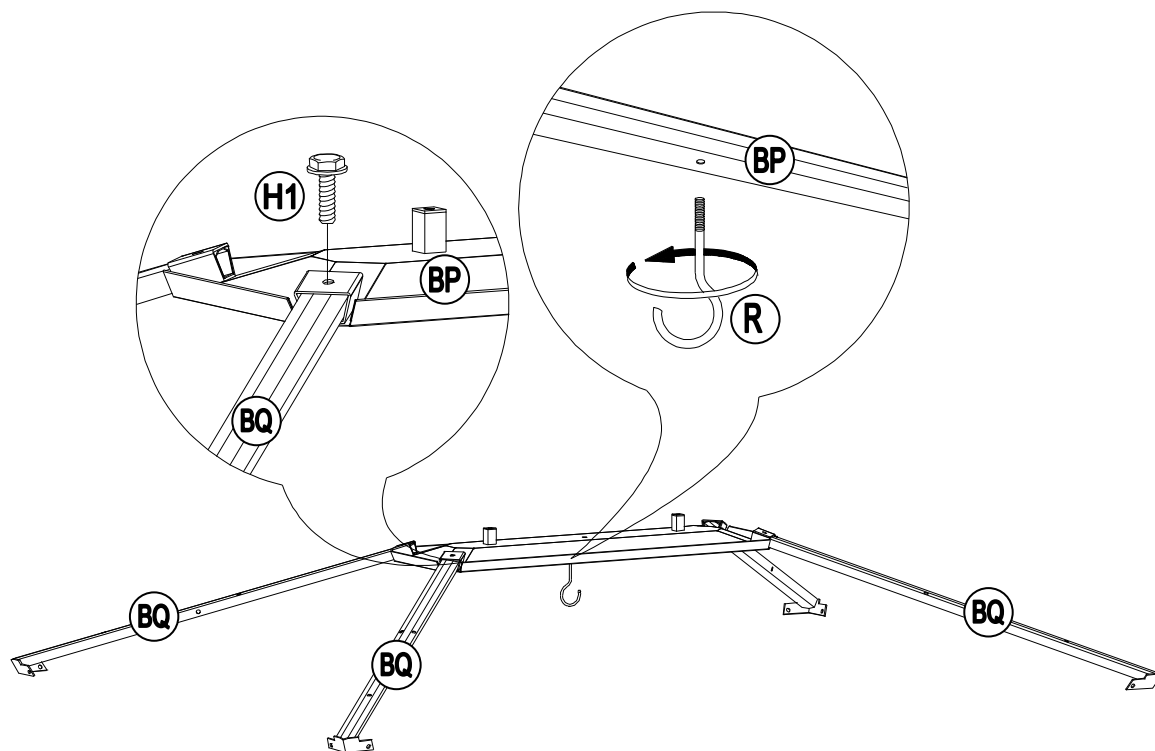
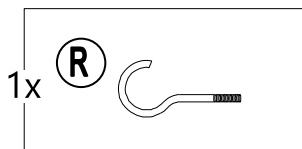
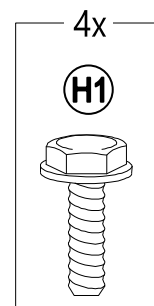
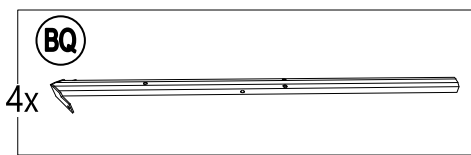
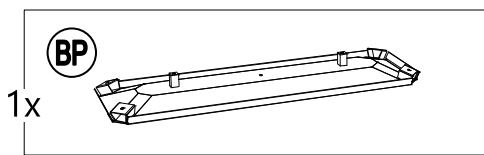



# 15

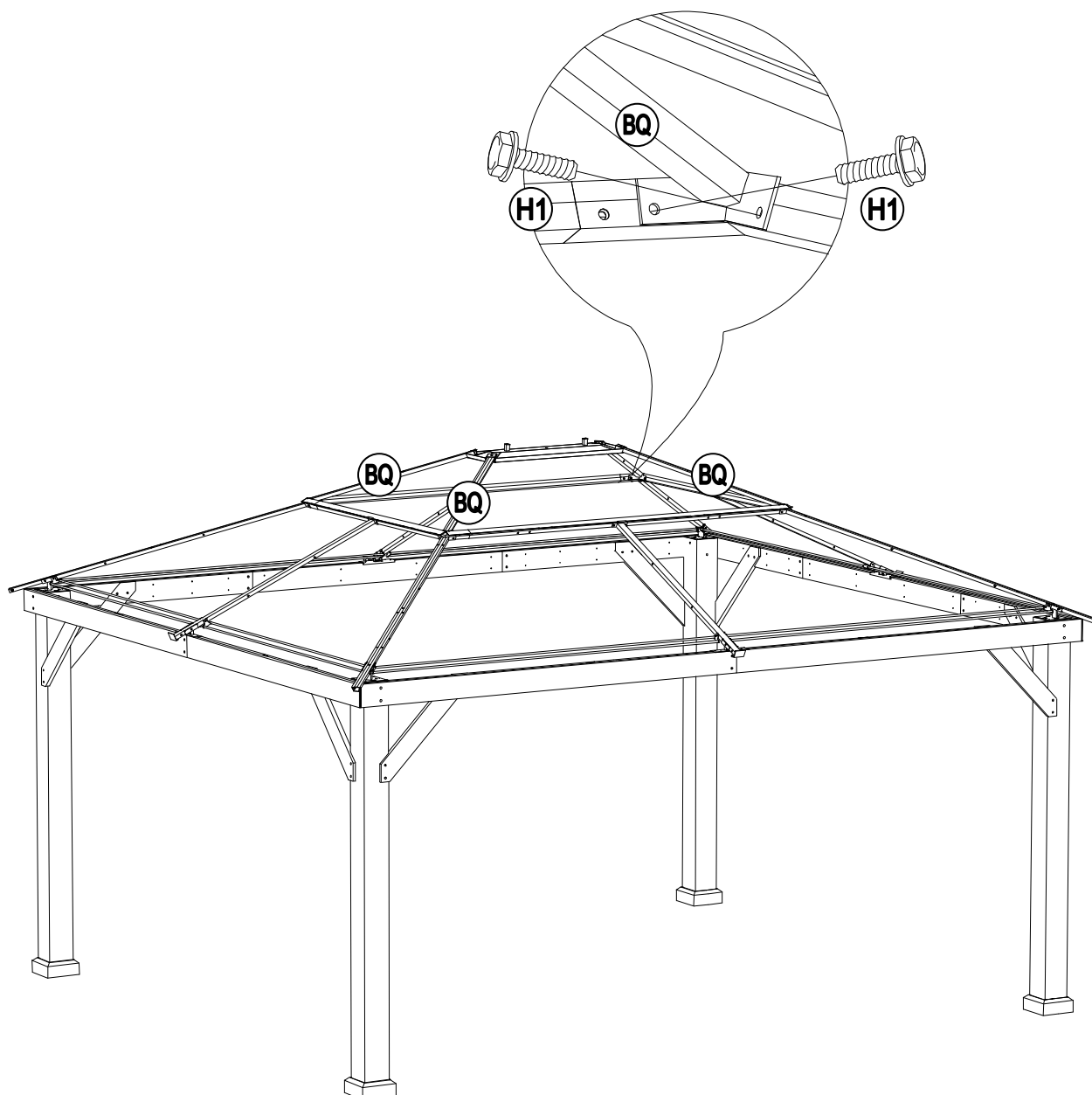
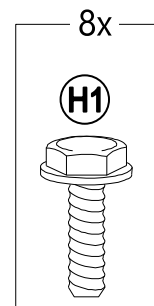
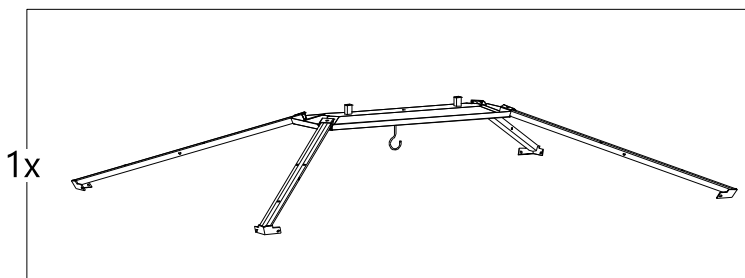

# 16

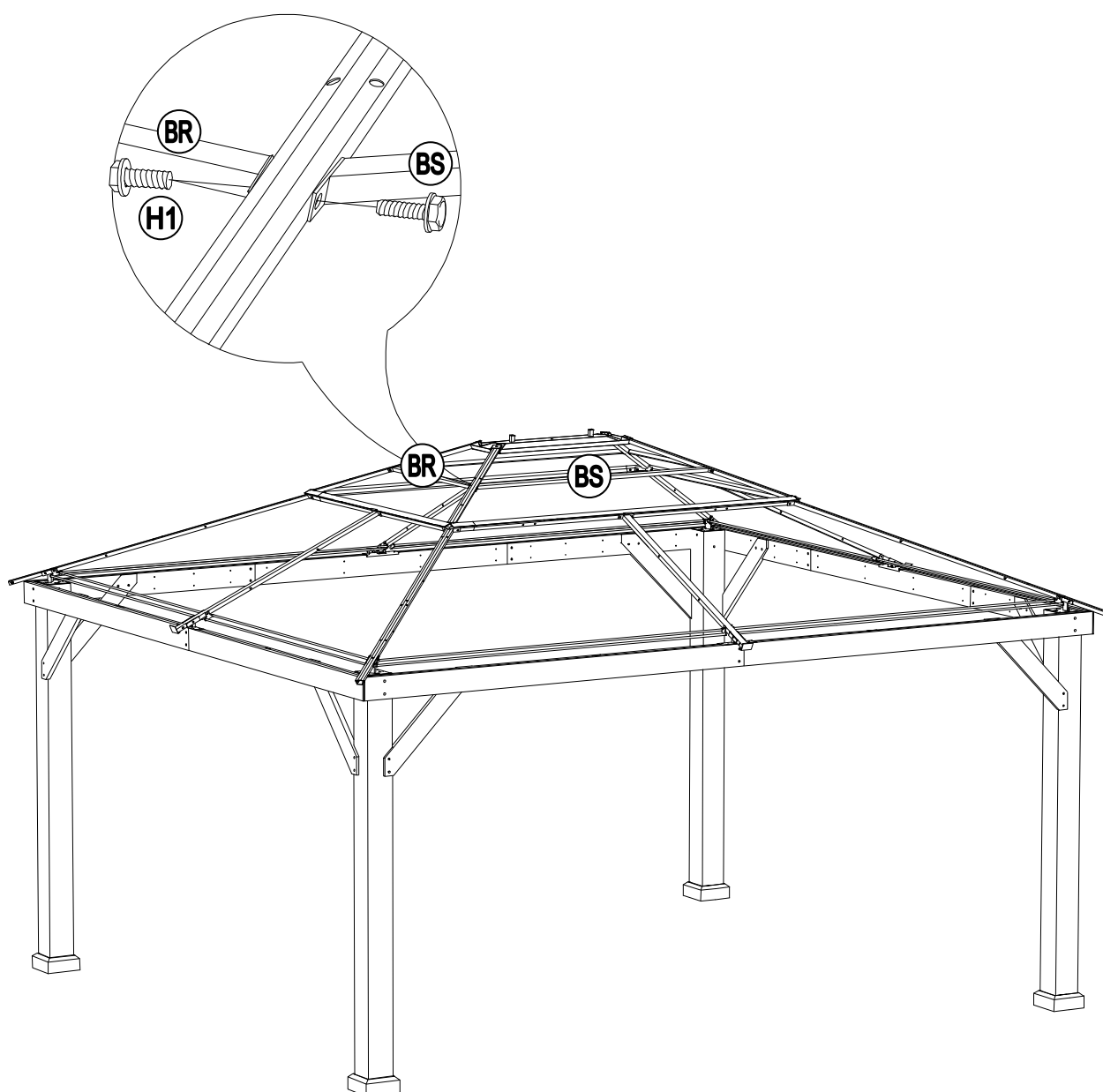
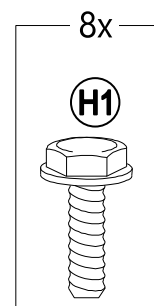
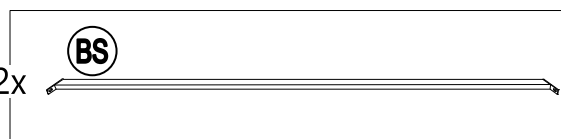
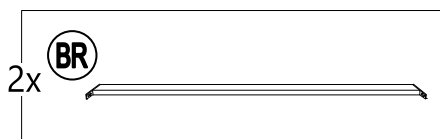

Country of Origin: China

# 17

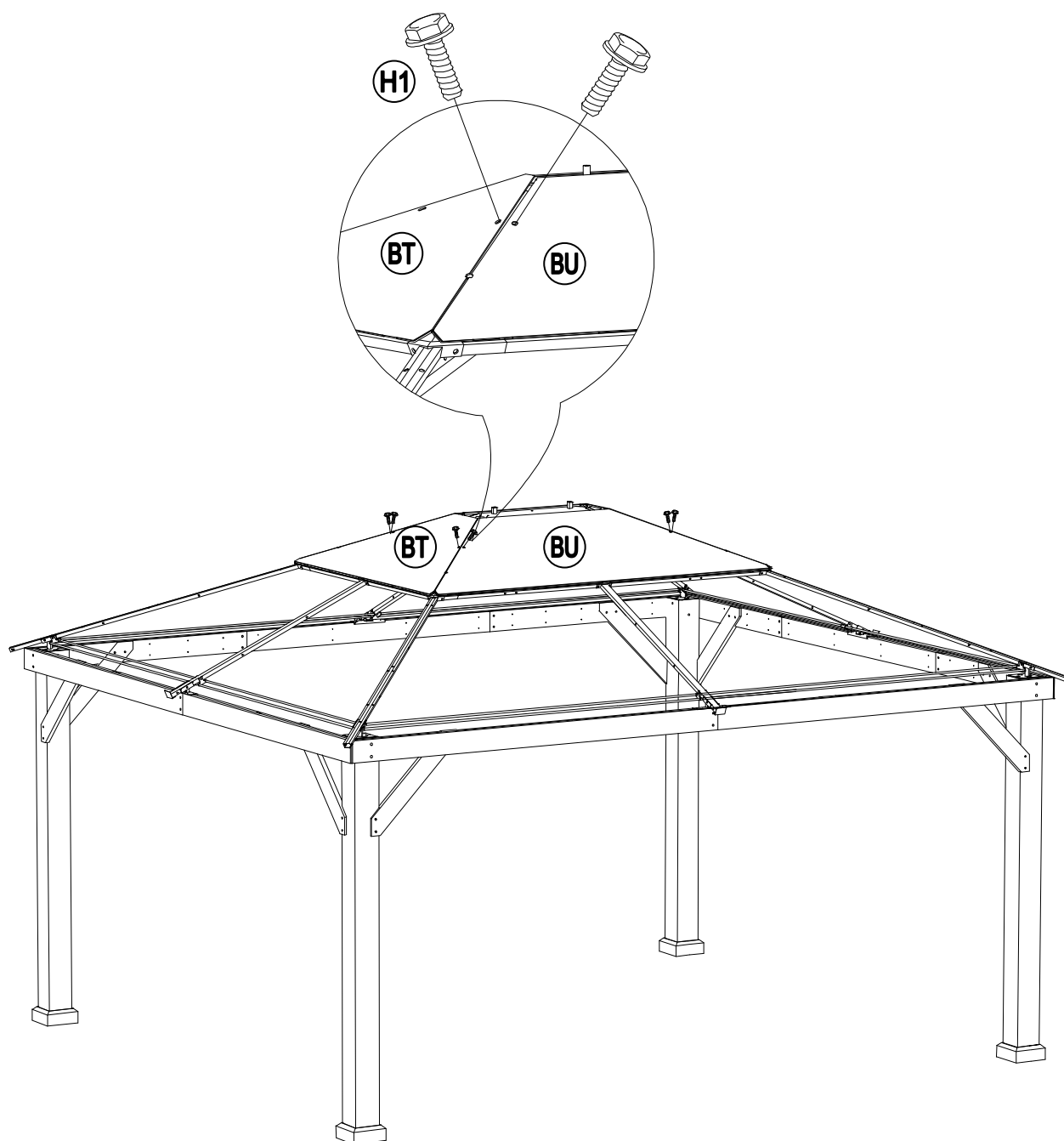
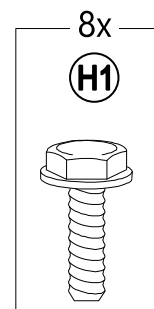
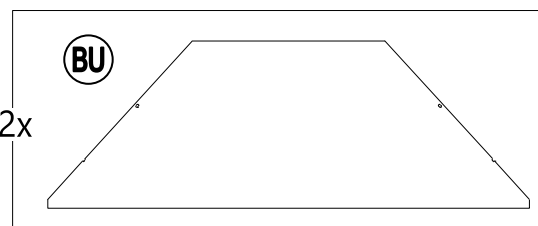
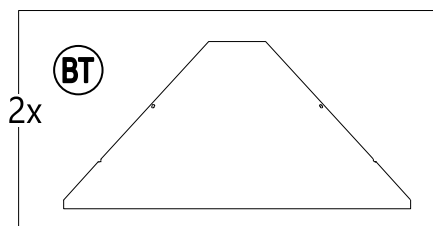

# 18

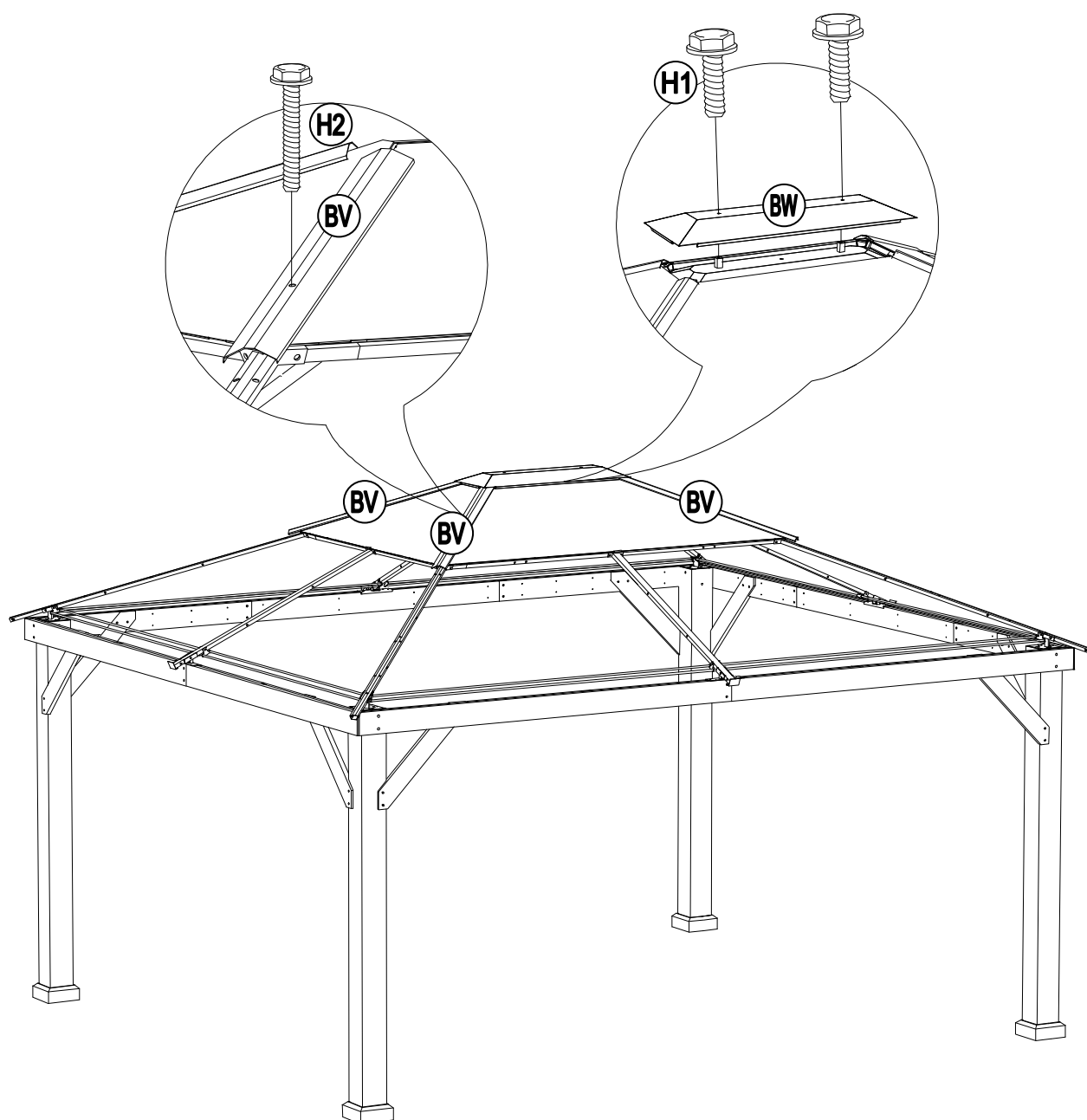
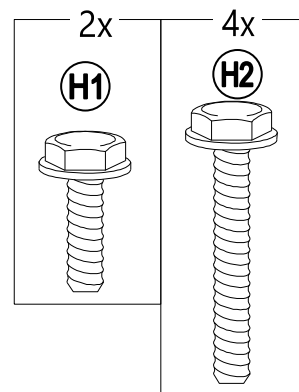
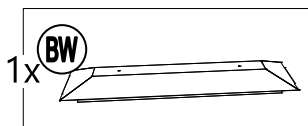
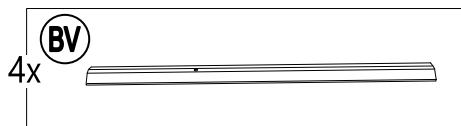

# 19

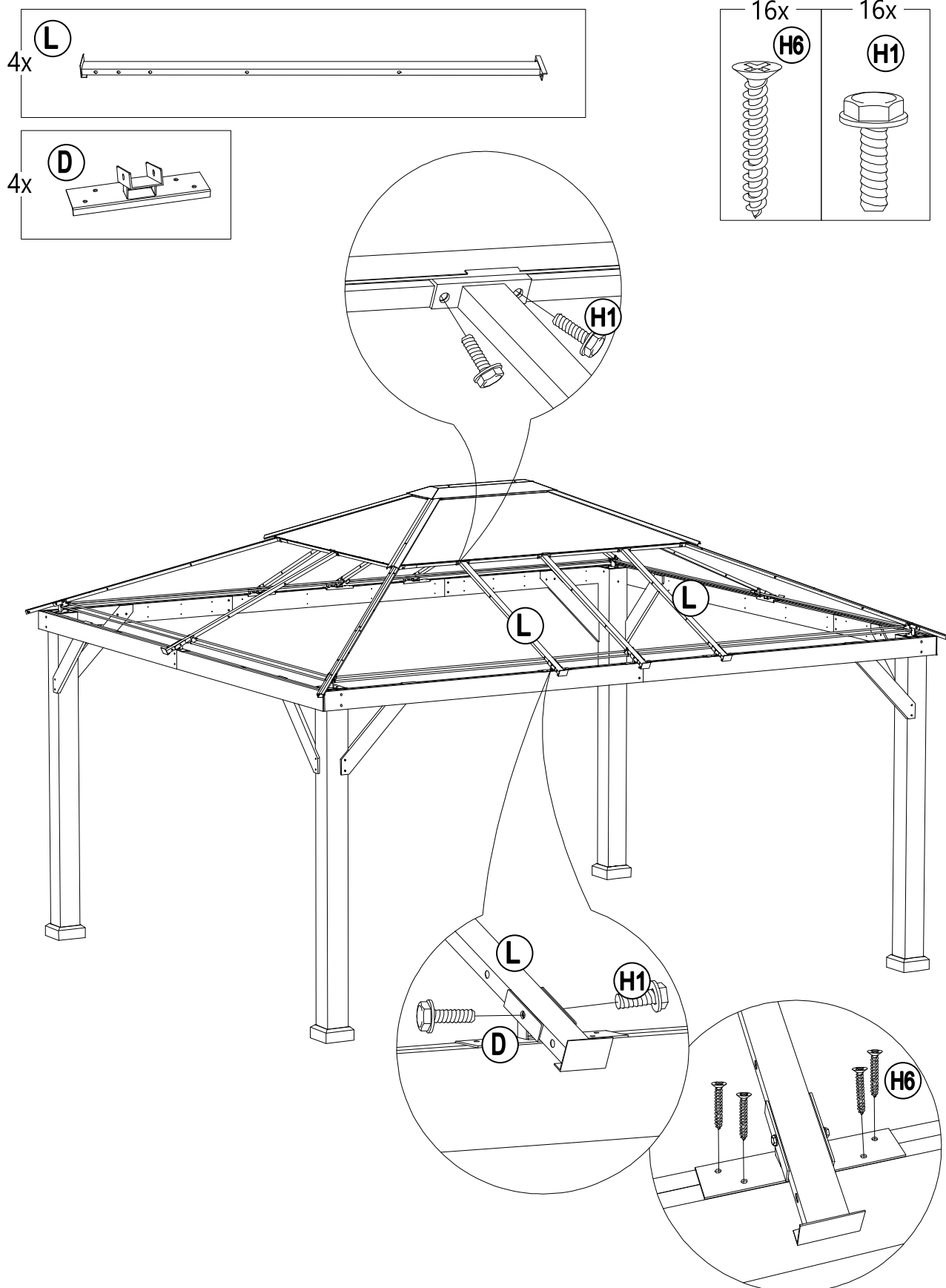

# 20

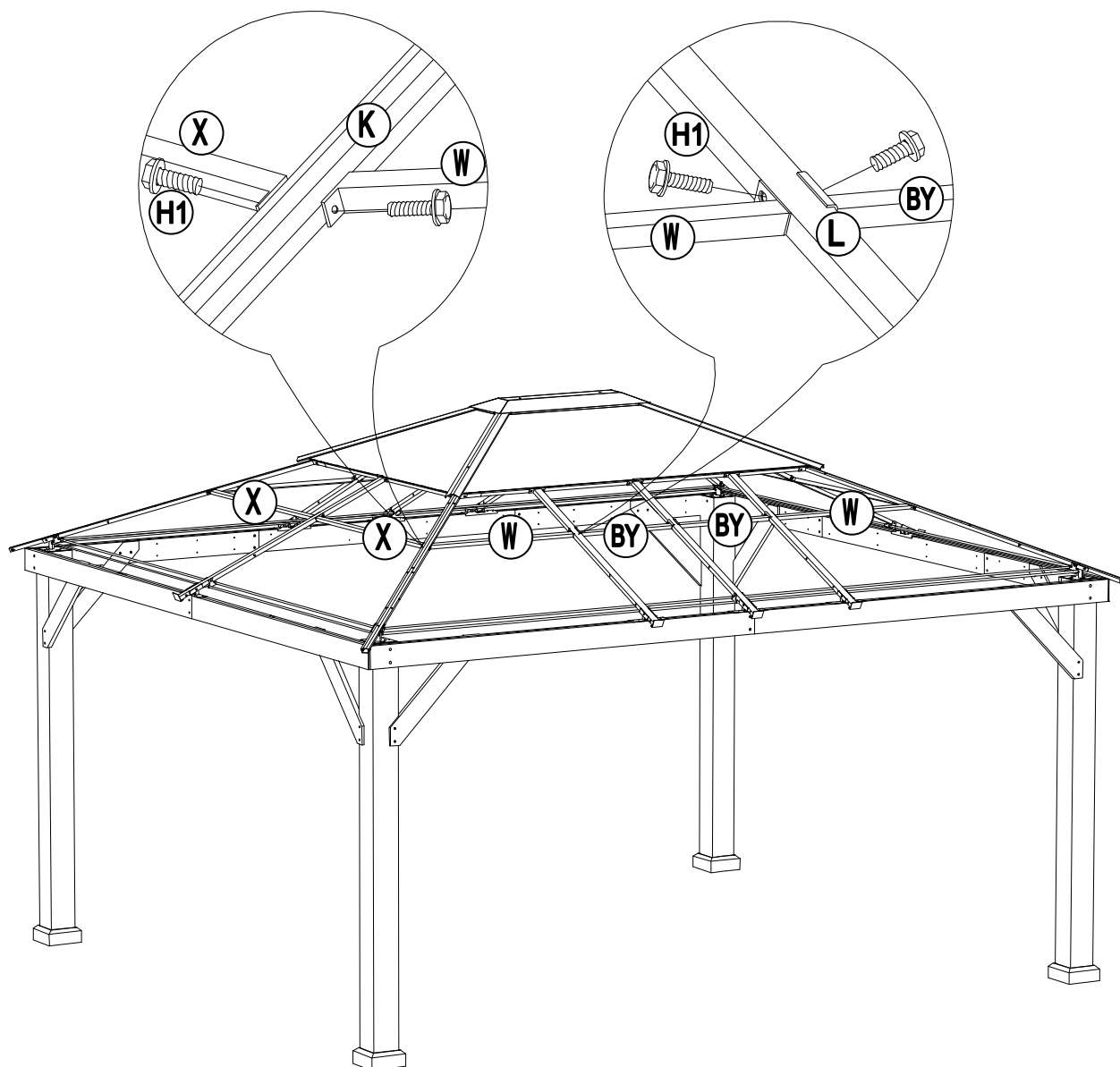
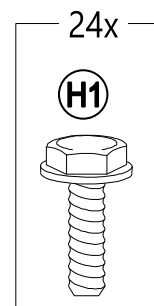
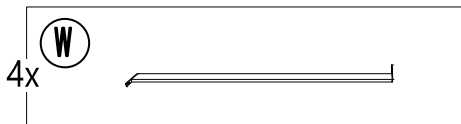
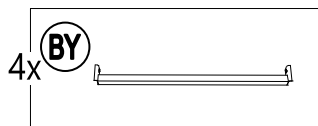
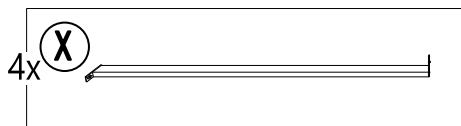

Country of Origin: China

# 21

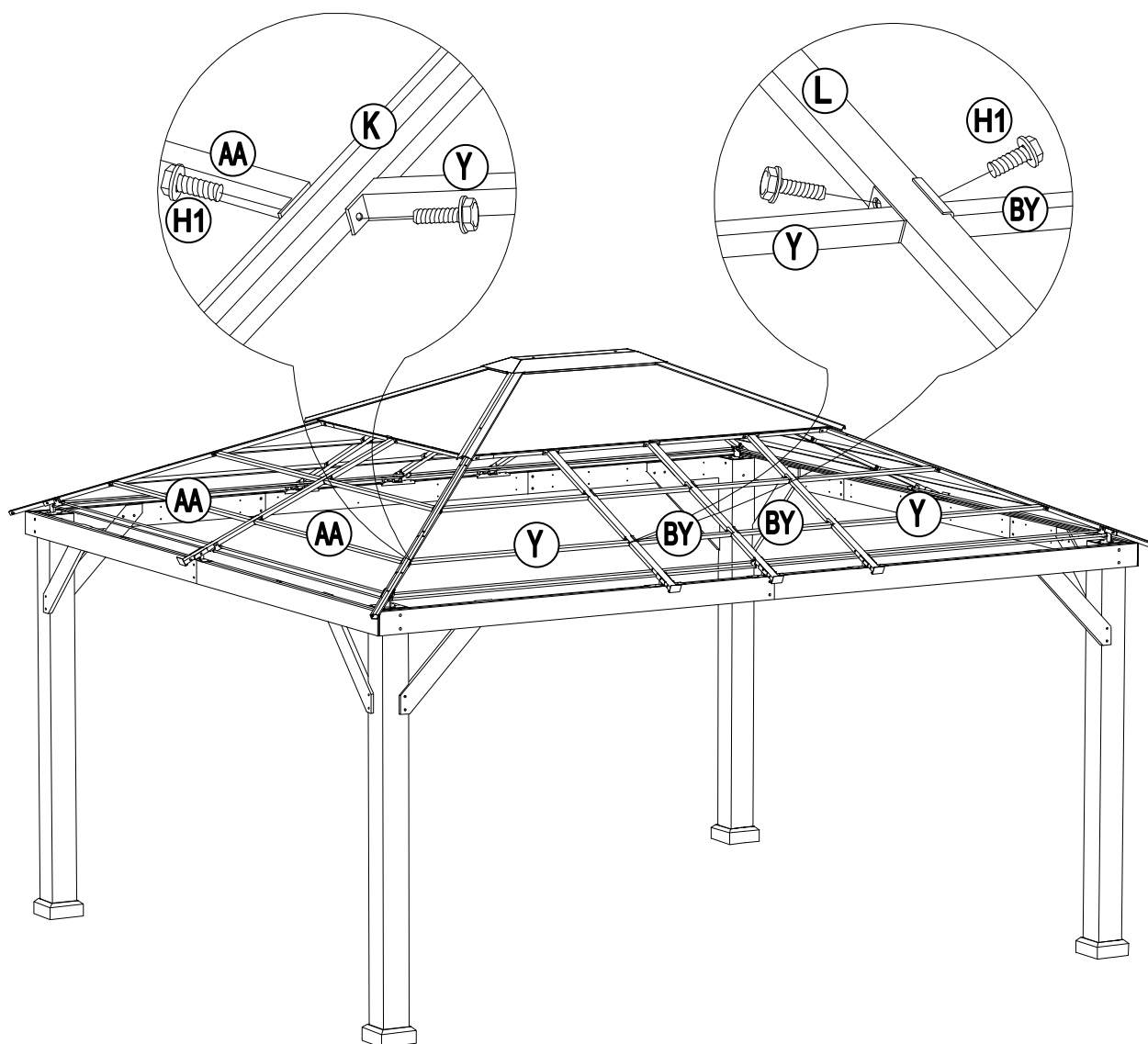
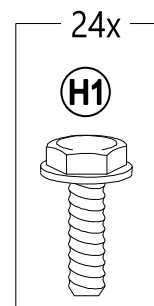
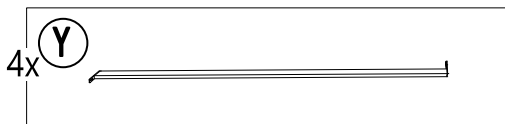
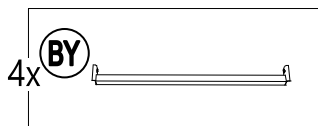
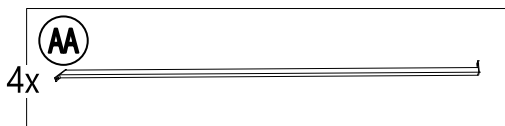

# 22

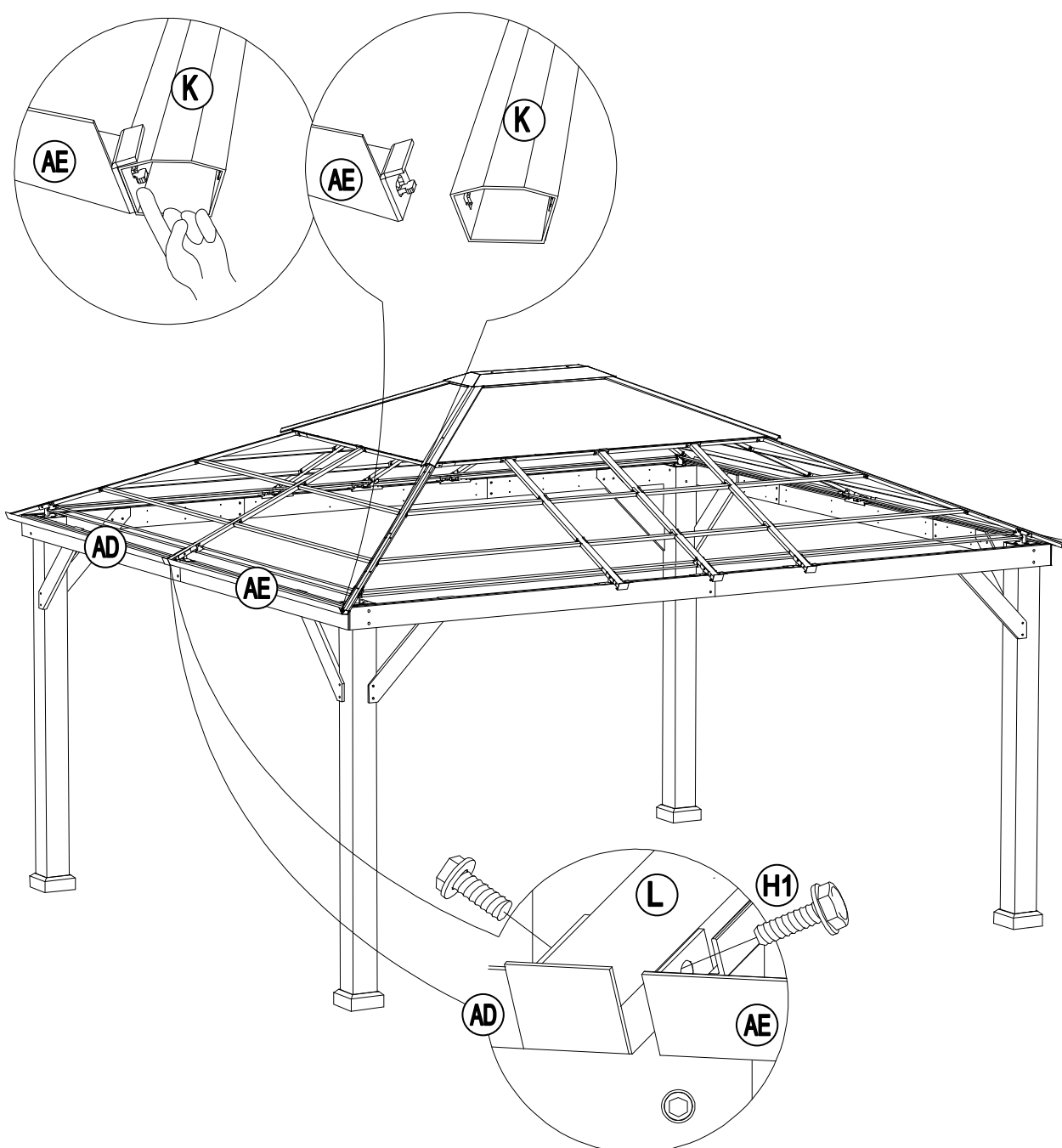
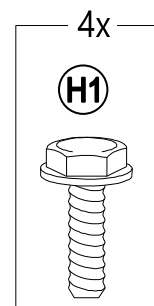
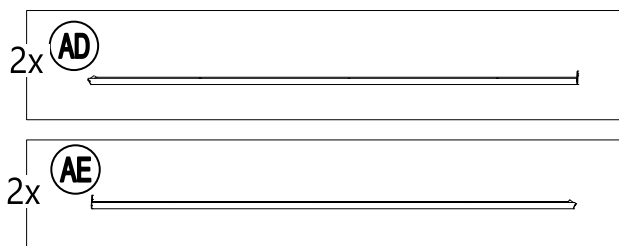



# 23

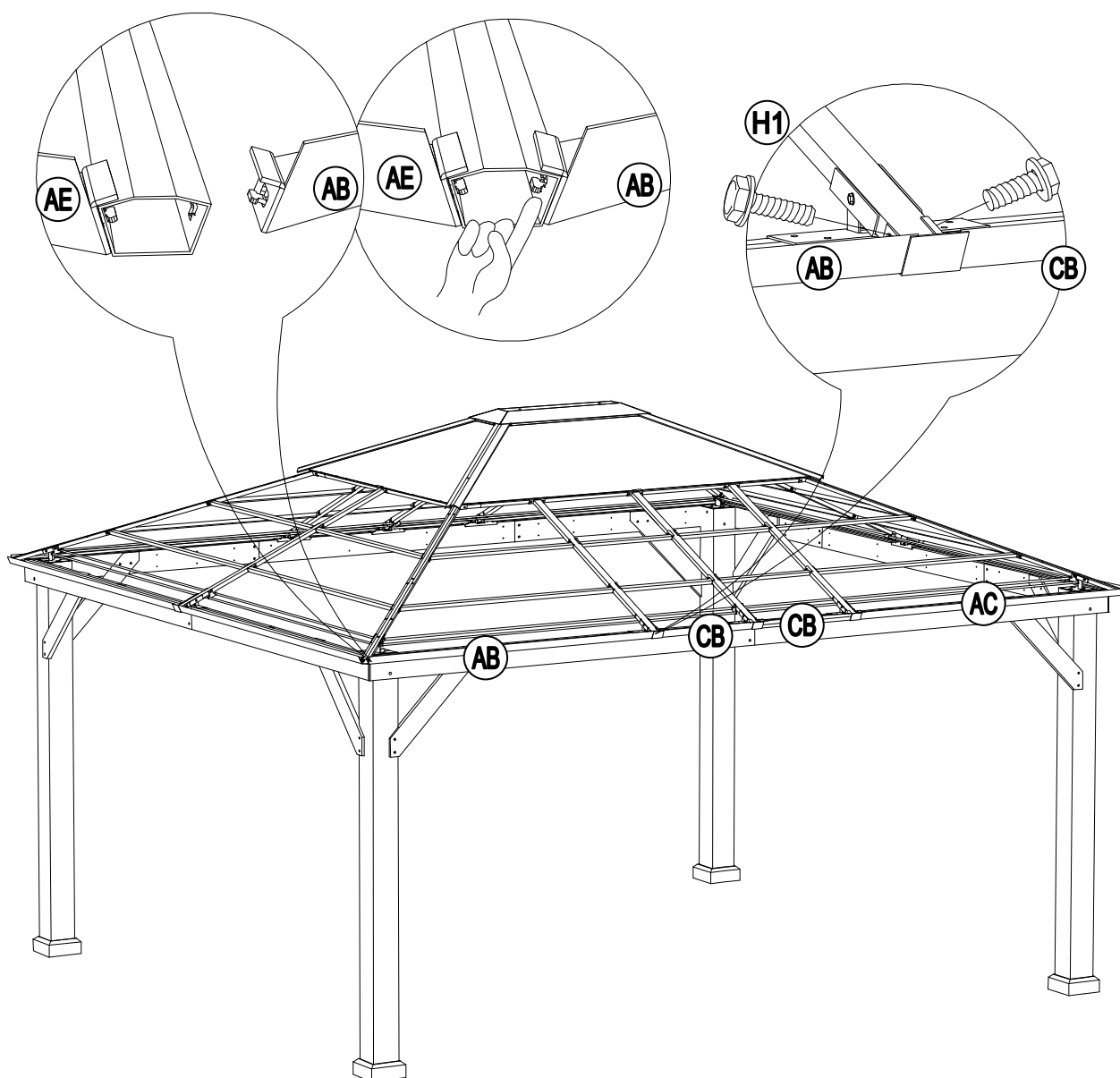
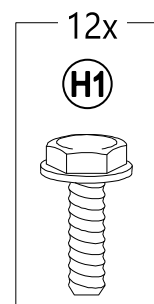
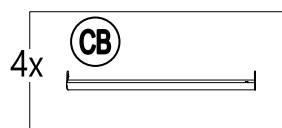
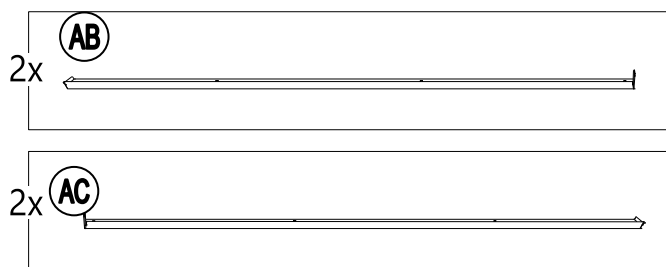

# 24

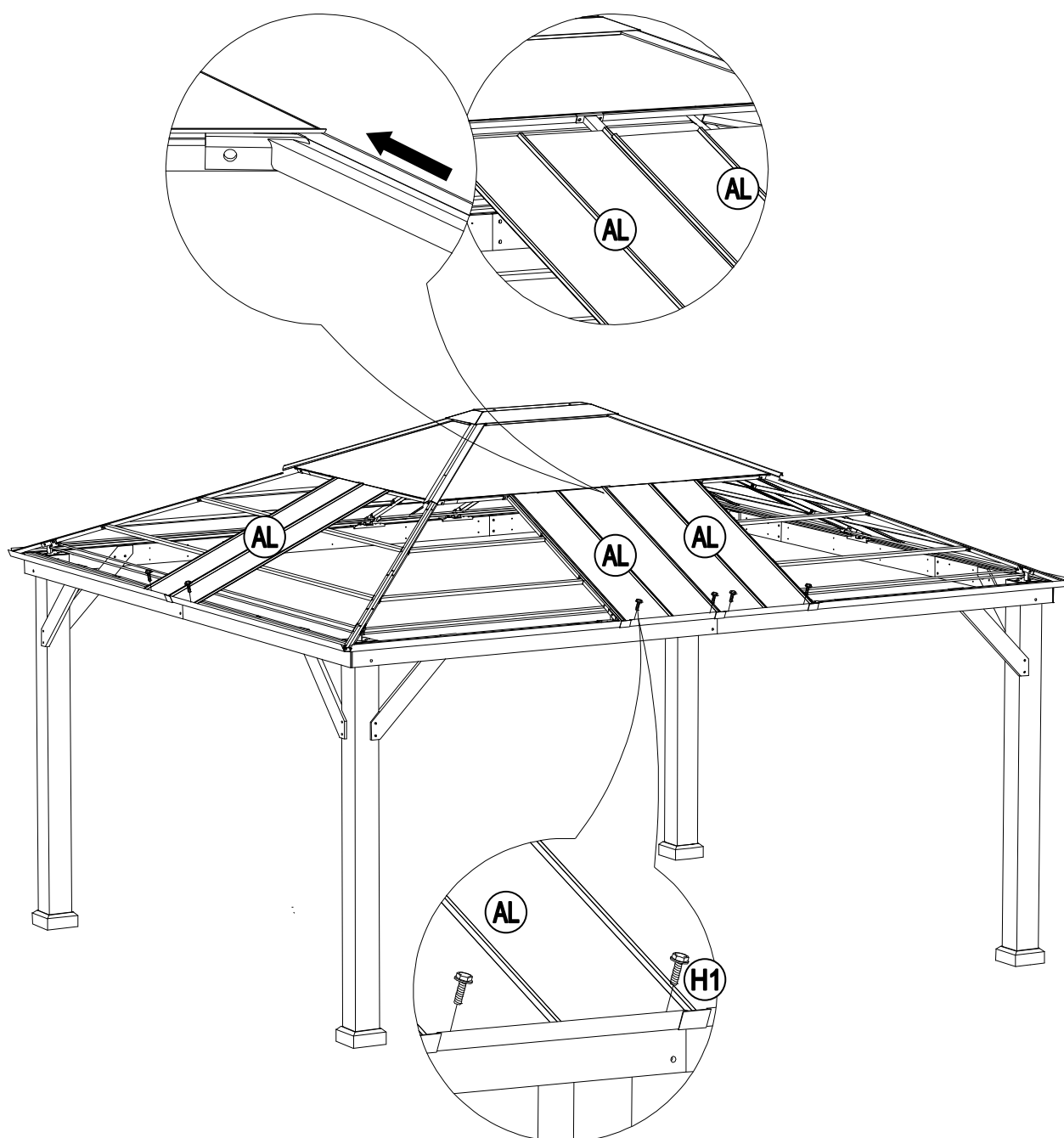
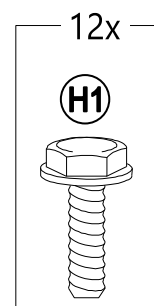
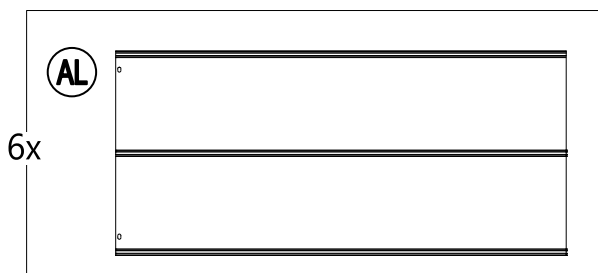

# 25

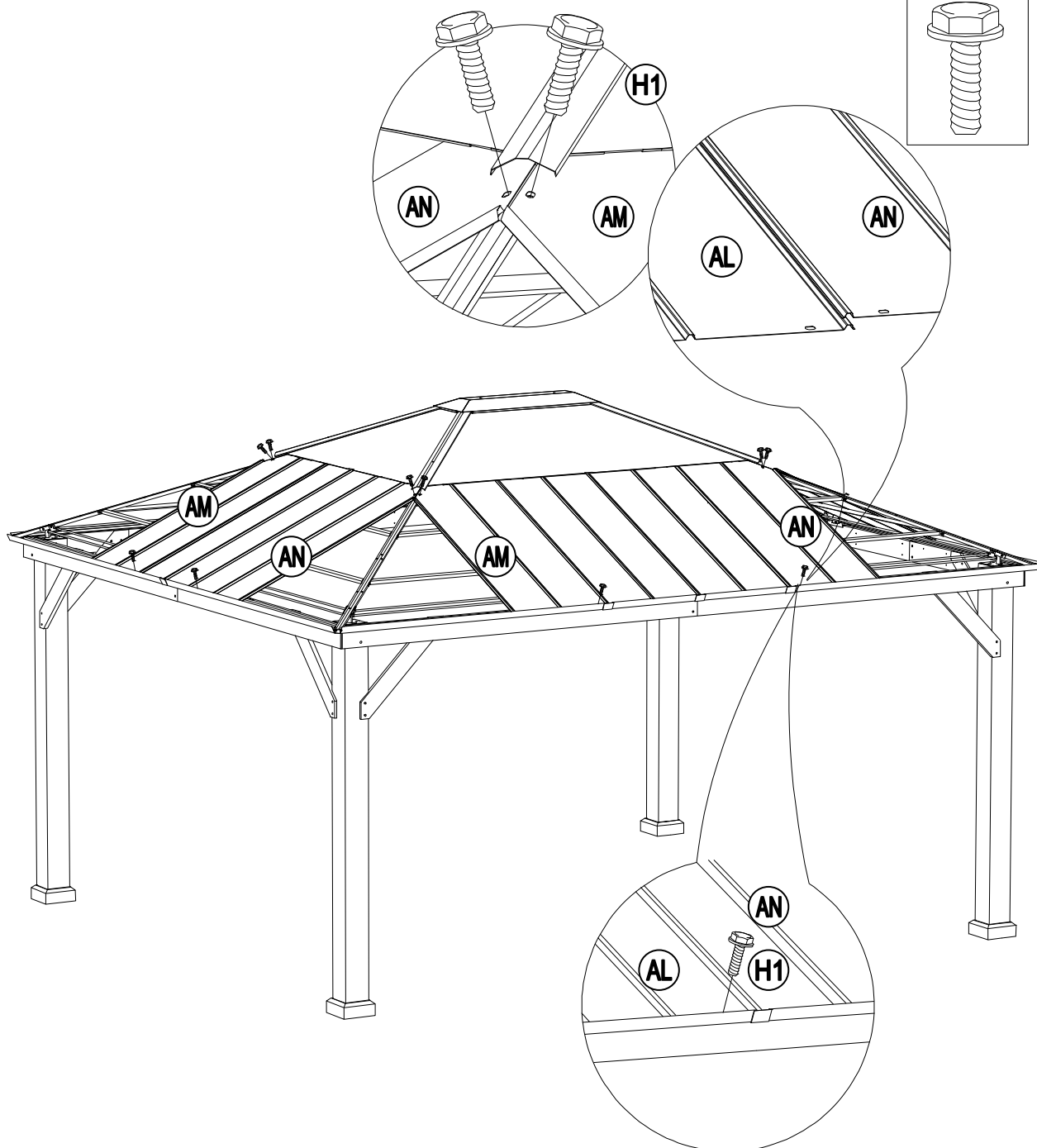
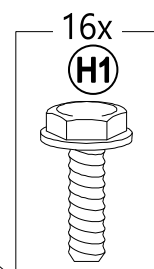
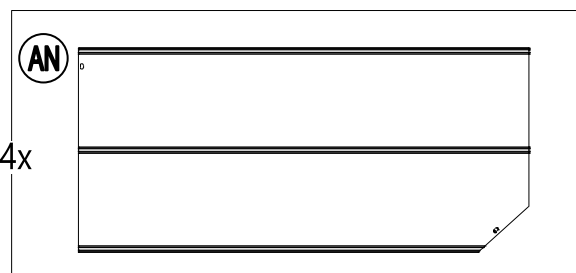
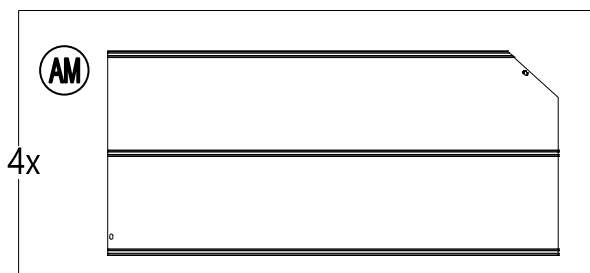

Country of Origin: China

# 26

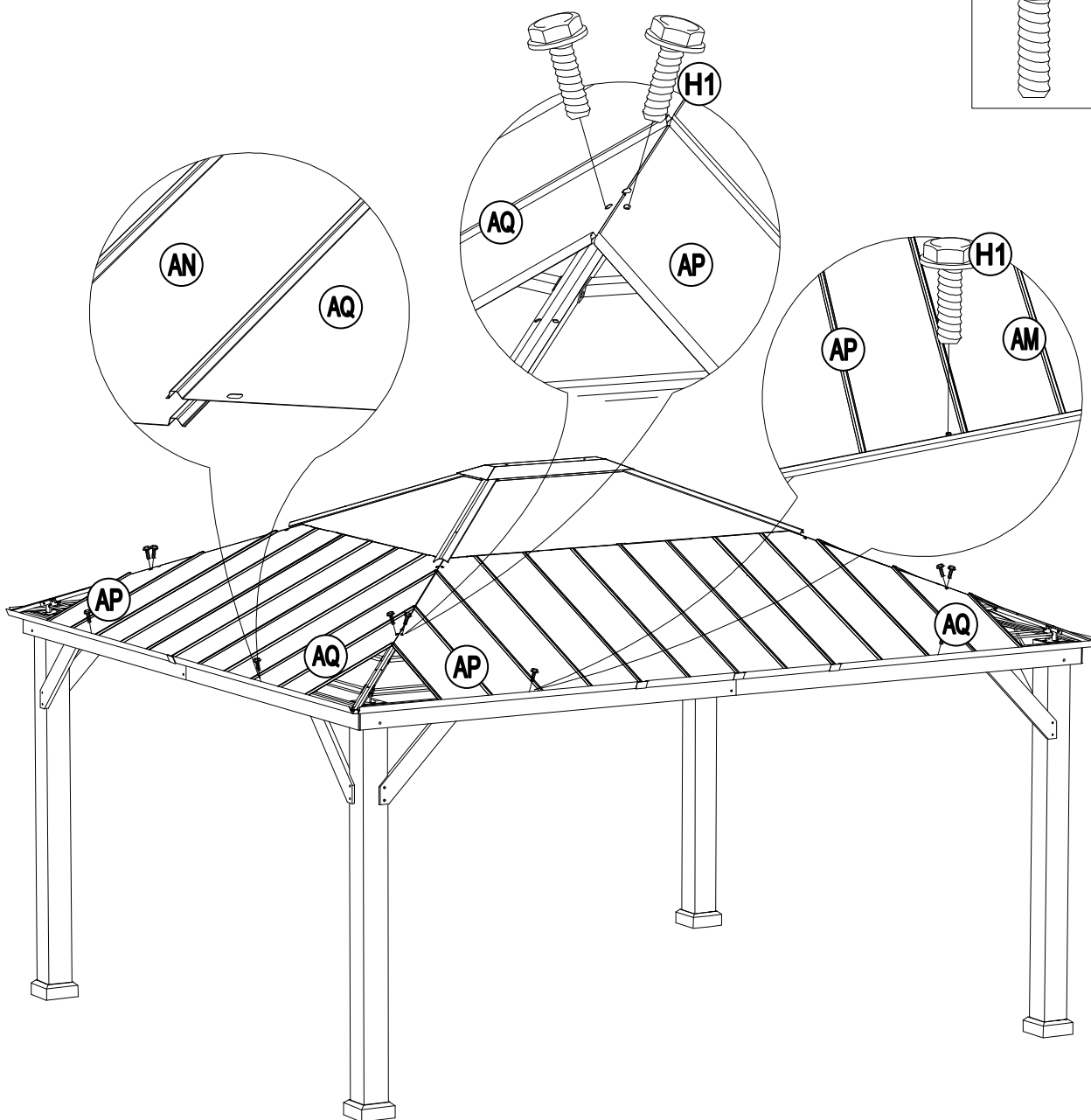
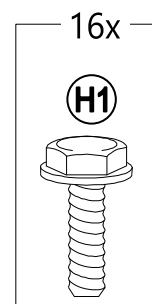
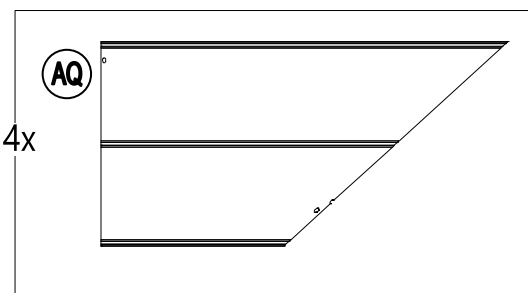
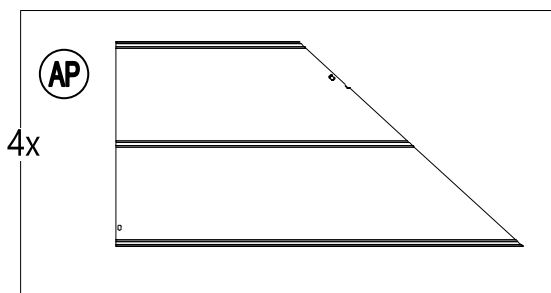

Country of Origin: China

# 27

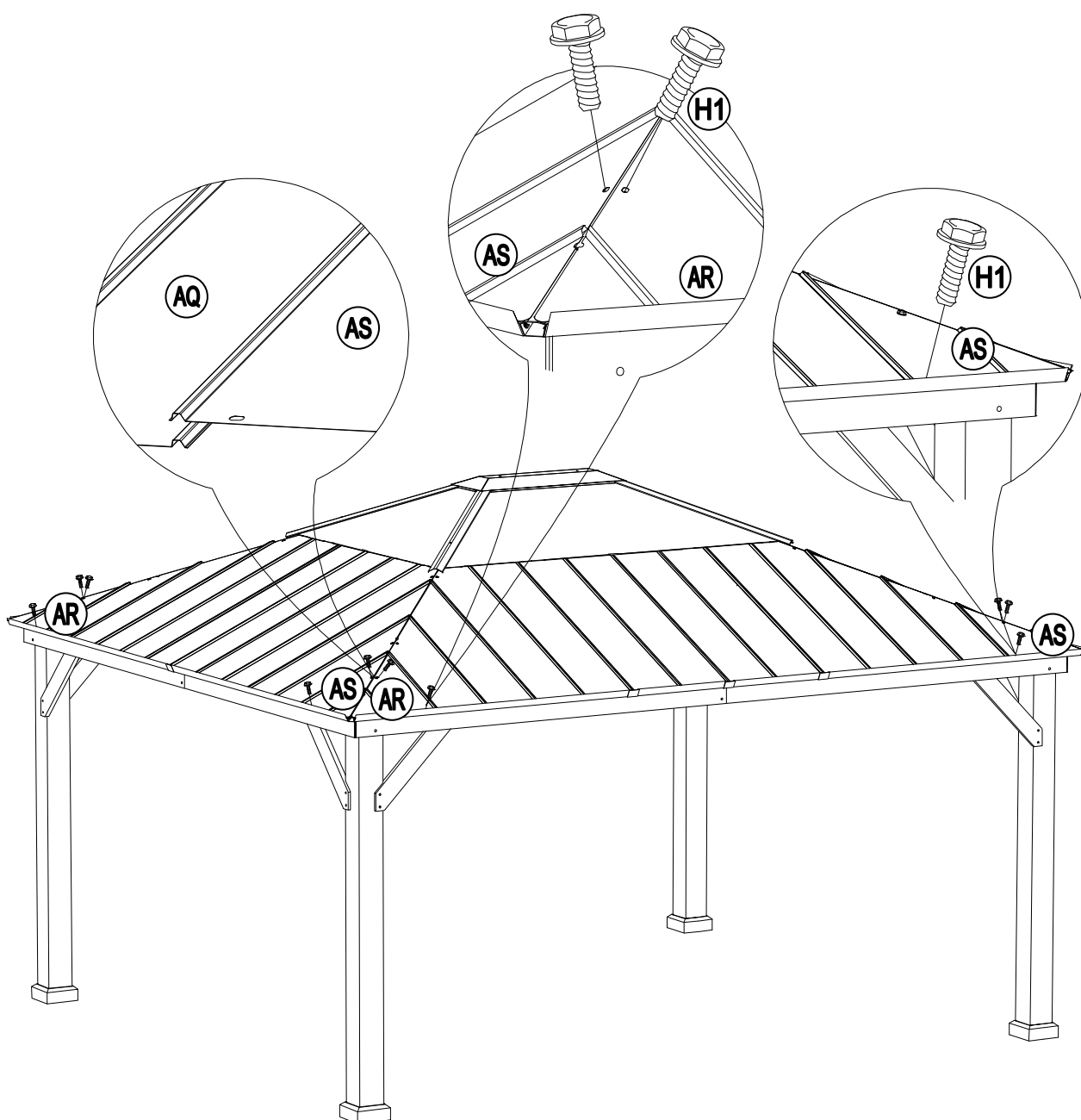
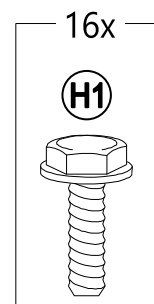
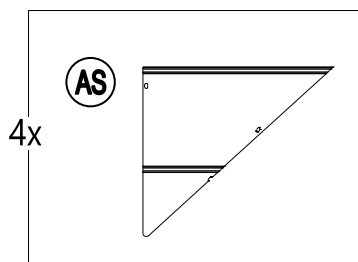
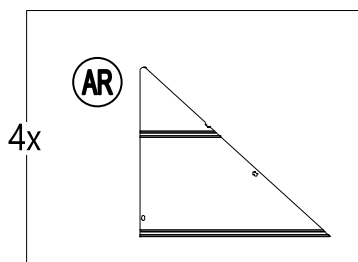

# 28

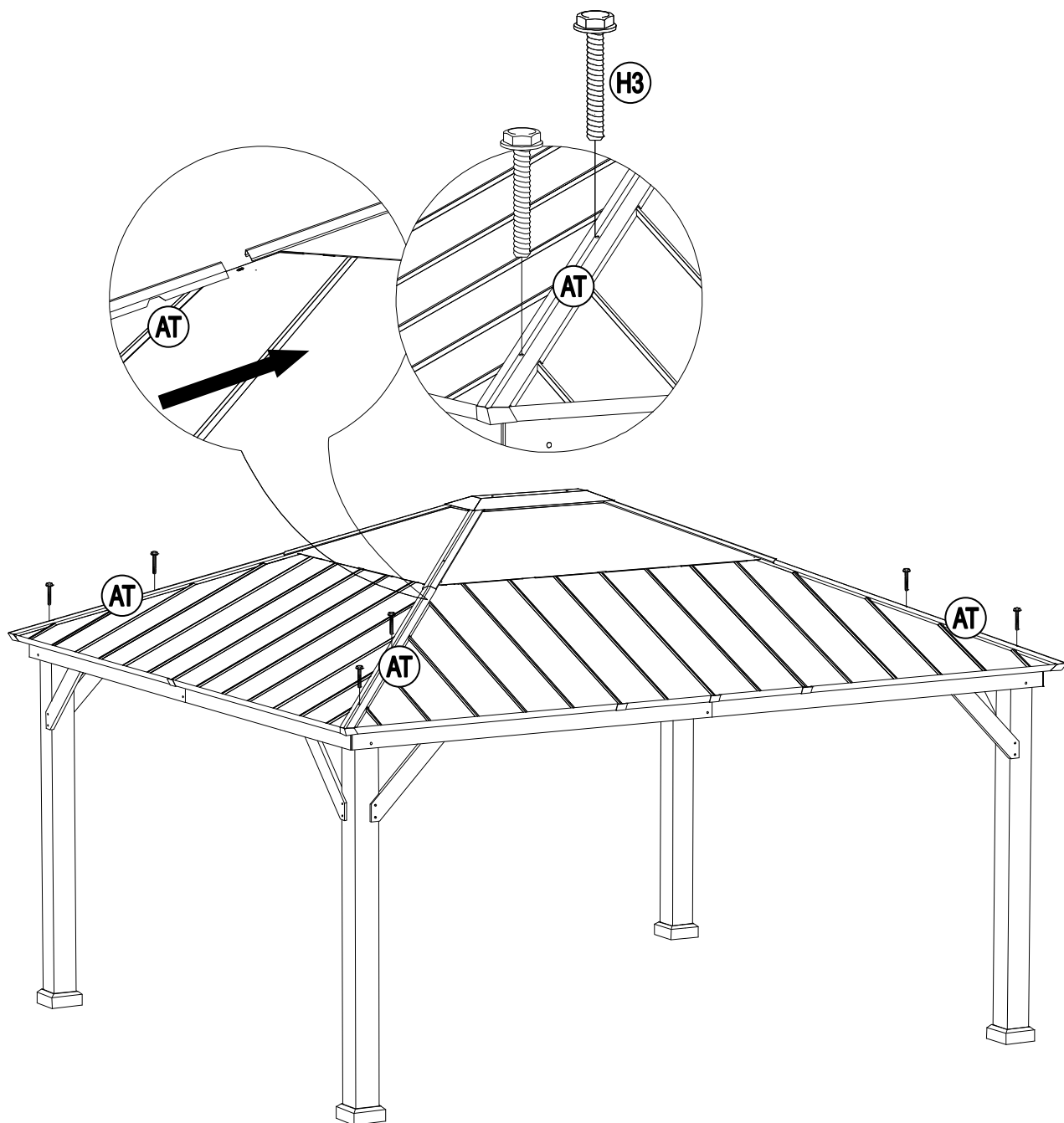
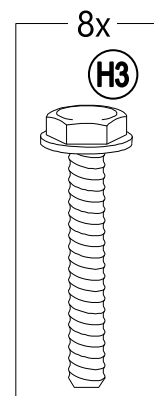
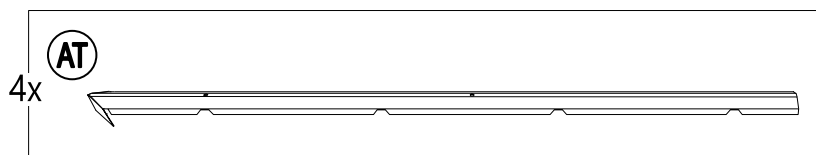

# 29

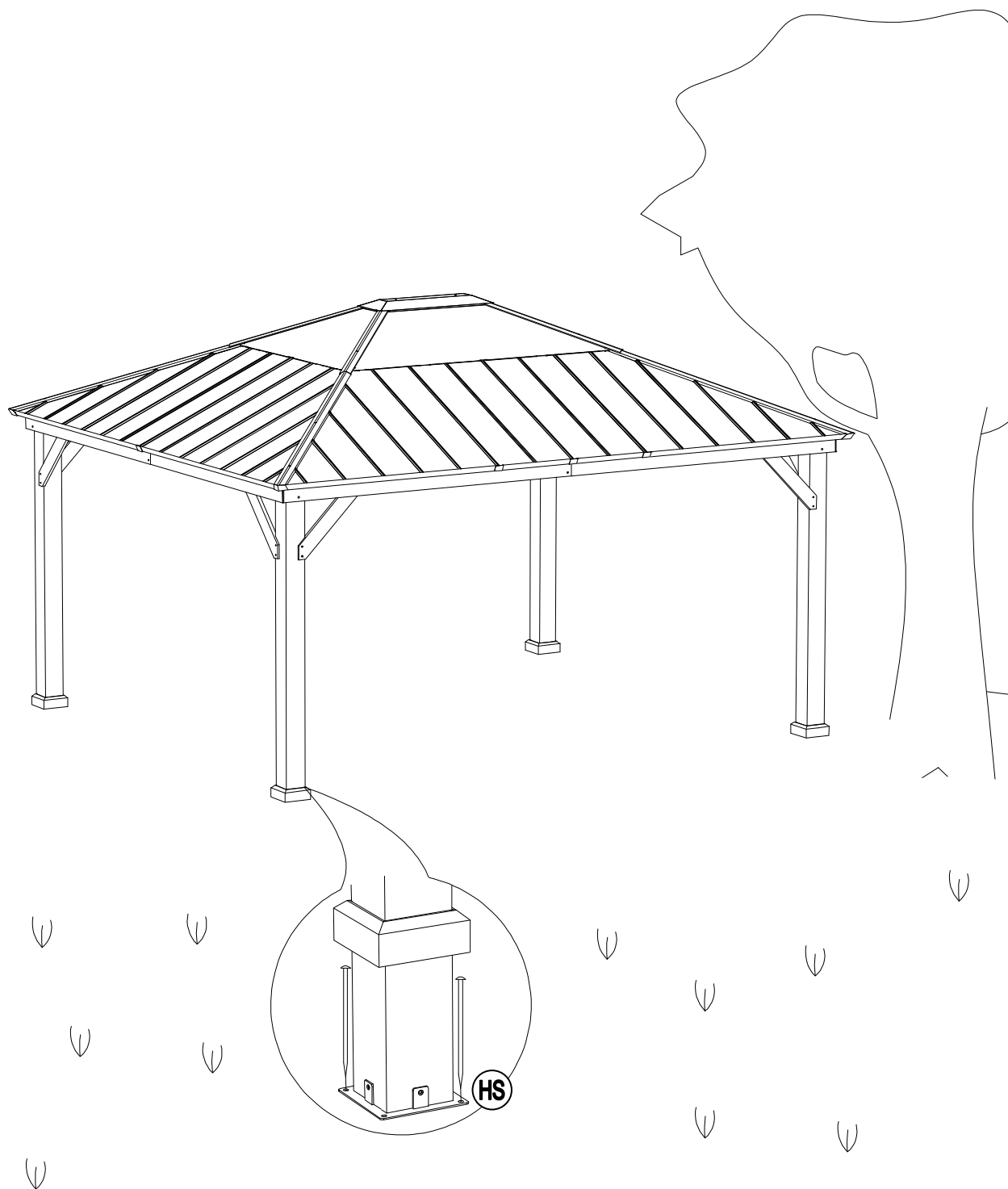
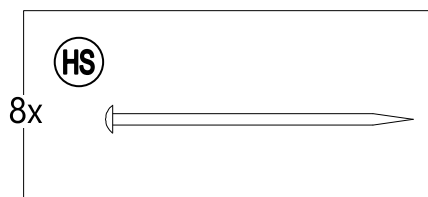

## Care and Maintenance

- Our steel components for garden accessories and furniture are treated with rust inhibiting paint that protects it from rusting. However, due to the nature of steel, surface oxidation (rusting) will occur once these protective coatings are scratched. This is not a defect and thus not covered by the warranty.
- To minimize this condition, we recommend care when assembling & handling the product to prevent scratching the paint. Should any scratching or damage occur, we recommend immediate touch-up with rust inhibiting paint.
- Surface rust can also be easily removed with a very light application of common cooking oil. If surface oxidation (rusting) occurs and if no measure is taken to prevent this, the oxidation may start dripping on to deck or patio and caused damaging stains, which may be difficult to remove. This can be prevented if the above-mentioned measures are taken to keep the product from oxidizing.
- Use damp cloth to wipe off the stains as quickly as possible.
- If necessary, wash with a mild solution of soap and water; rinse thoroughly and dry completely.
- Periodically check and ensure that all bolts are well-tighten during use

## Limited Manufacturer's Warranty

Sunjoy Group warrants to the original purchaser that this item is free from defects in workmanship and materials for a period of **1 year** from the date of purchase, provided the item was factory-sealed at the time of purchase and is maintained with care and used only for personal, residential purposes. Should any manufacturing defect arise within this warranty period, Sunjoy Group will replace (at our option) any defective merchandise or parts upon proof of purchase; however, transportation and delivery costs, as well as payments to a third party for assembly or disassembly of the item, remain the responsibility of the purchaser. A purchaser of an "open box," previously-returned, or "clearance" item, as well as original purchasers outside of the warranty period, may obtain replacement parts from Sunjoy Group for products in current production, at nominal cost.

## Exclusions

Items used for commercial, contract, or other non-residential purposes, or items damaged due to acts of nature, vandalism, misuse, or improper assembly are not covered. Corrosion or rusting of hardware is not covered. Proof of purchase (dated register receipt) is required for warranty claims. Warranty is to the original purchaser and is non-transferable. Any replacement of warranted items will be in the original style and color, or a similar style and color if the original is unavailable or has been discontinued. As some states do not allow exclusions or limitations on an implied warranty, the above exclusions and limitations may not apply. This warranty gives you specific rights, and you may also have other rights, which vary from state to state.

**Country of Origin: China**