

ITEM NO.: A101012400

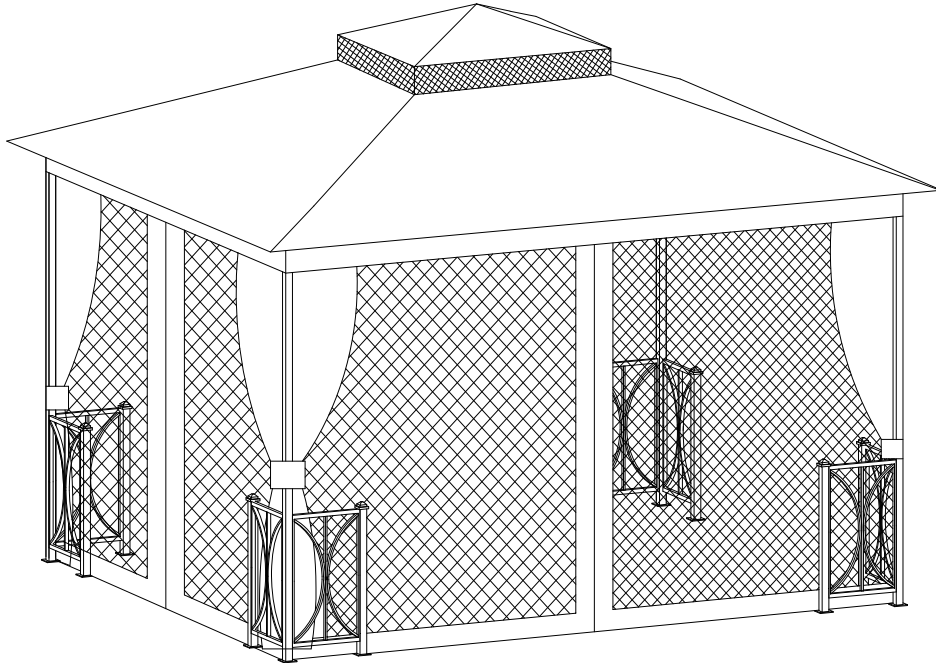

WE HAVE YOU IN MIND, LET US SERVE YOU!

Questions? Issues?

CONTACT US

24 hours / 7 days a week

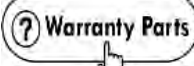

www.sunjoyonline.com



customer.care@sunjoygroup.com



A10101241022

Country of Origin: China

Production Number: xxxxxxxxxxxx

Safety Information

- **two people** are required for this assembly.
- Some parts may contain sharp edges. Wear protective gloves.
- When assembling and using this product, basic safety precautions should always be followed to reduce the risk of personal injury and damage to equipment. Please read all instructions before assembly and usage.



CAUTION: Do not climb on top of the gazebo. Falling off the gazebo can result in serious injury.

NOTICE: For outdoor use

Warranty: 1 Year



DANGER: This unit is heavy! Do not assemble this item alone.



WARNING: Do not leave the gazebo where there is a risk of high wind, as possible damage will occur to the structure.



WARNING: Keep all flame and heat sources away from this gazebo fabric. This Gazebo is made with fabric that meets CPAI-84 specifications for flame resistance. It is not fire proof. The fabric will burn if left in continuous contact with any flame source. The application of any foreign substance to the gazebo fabric may render the flame-resistant properties ineffective.

WHAT IS COVER?











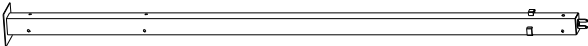







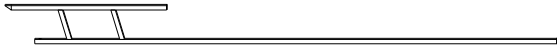

The limited warranty is extended to the original purchaser and applies to material and manufacturer's defect provided the item is maintained with care and used only for personal, residential purposes.

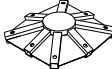
IMPORTANT

KEEP THIS INSTRUCTION MANUAL FOR FUTURE REFERENCE.

Country of Origin: China

Parts List

Description	Label	Part#	Qty	Image
Post	A	P00020060701	4	
Fence	B	P006200012	8	
Long screen 1	D	P00040117001	2	
Long screen 2	E	P00040117101	2	
Short screen 1	F	P00040117201	2	
Short screen 2	G	P00040117301	2	
Long netting rod	H	P005700657	4	
Short netting rod	I	P005700656	4	
Long middle beam	J	P00060205302	2	
Short middle beam	K	P00060205104	2	
Slanting beam	L	P00060121902	4	
Slanting bottom tube	M	P00060122302	4	
Large top connector	N	P00050026302	1	
hook	R	P005800001	1	
Adjustable tube	C	P005700029	4	
Beam connector	S	P00050026402	4	
Small canopy	T	P00110067401	1	
Large canopy	U	P00110067301	1	
Mosquito netting	V	P001200213	1	
curtain	W	P001300105	1	

Country of Origin: China

Hardware Pack 1

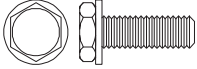
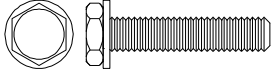
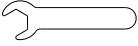
Description	Label	Part#	Qty	Image
M6*20 bolt	AA	H100010047	24 PCS	
M6*25 bolt	HH	H100010086	32 PCS	
M6 wrench	II	H090010017	2 PCS	

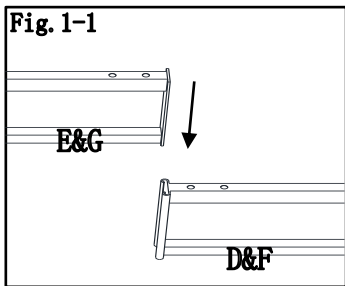
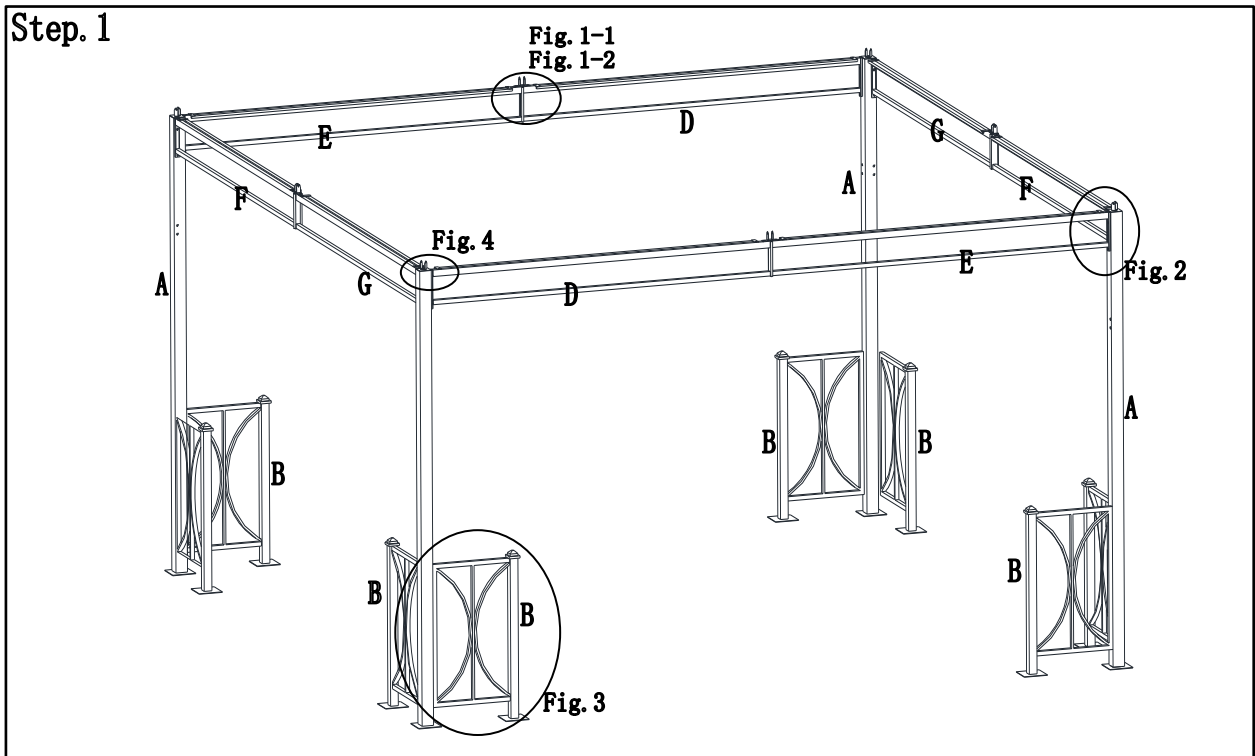

Fig.1-1:Insert long screen1 (D) into long screen 2(E).

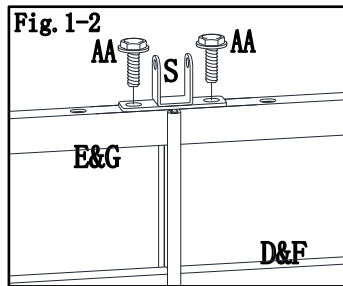

Fig.1-2:Fix middle beam connector(S) to screen, by using bolt(AA).

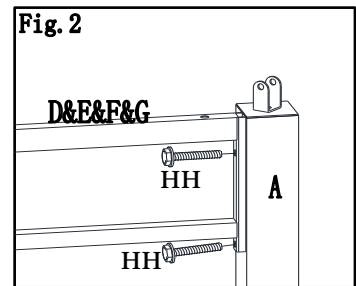

Fig.2: By using bolt(HH) fix screen to post(A).

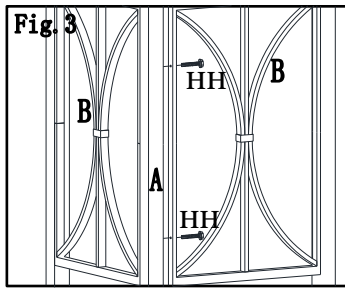

Fig.3: Attach fence(B) to post(A),by using bolt (HH).

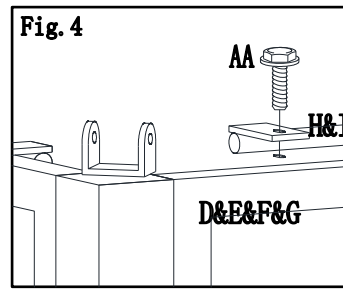

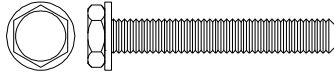

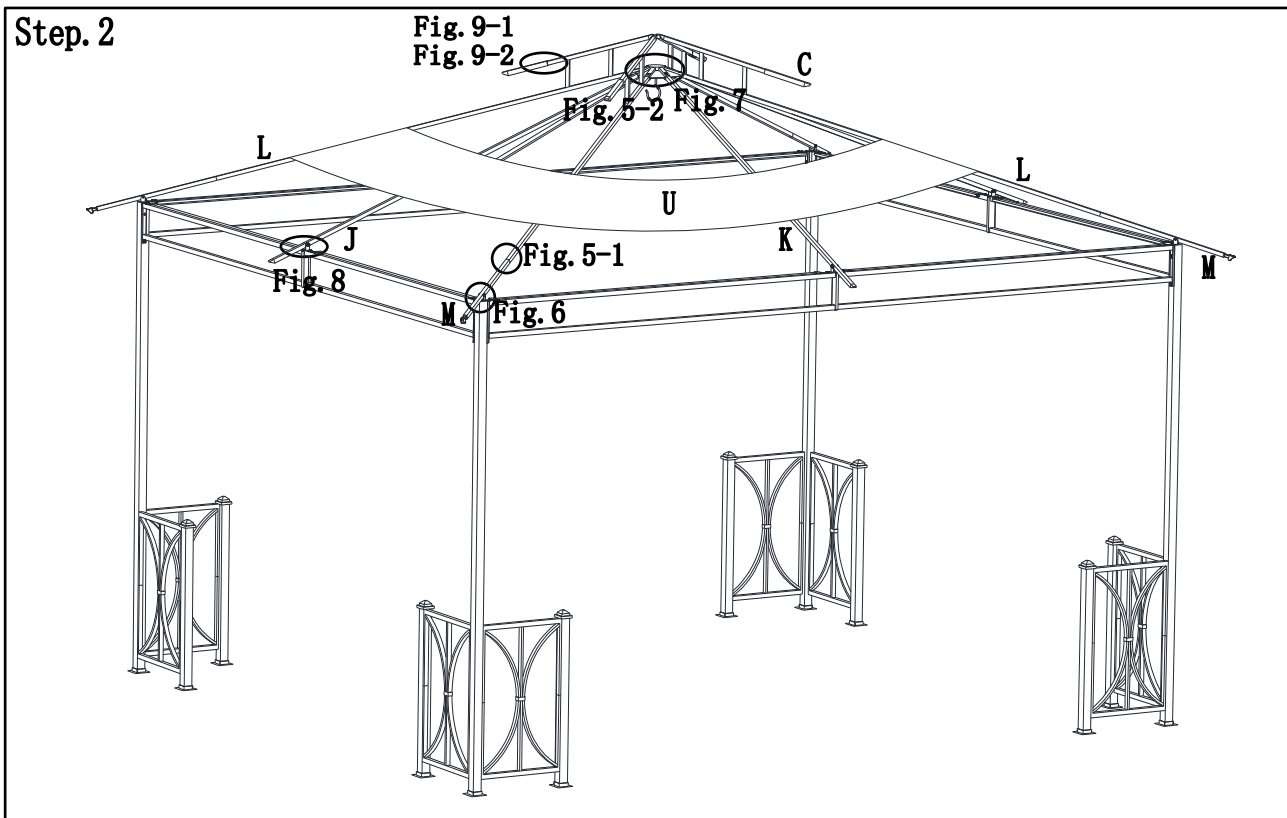

Fig.4: Attach long netting rod(H) to long screen, short netting rod(I) to short screen, by using bolt(AA).

Hardware Pack 2

Description	Label	Part#	Qty	Image
M6 washer	BB	H050030001	8 PCS	
M6*35 bolt	CC	H100010069	8PCS	
M6 nut	DD	H040010004	8PCS	



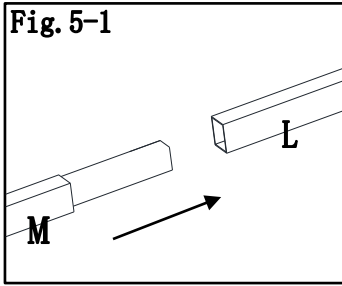

Fig.5- 1:Insert slanting bottom tube(M) into slanting beam(L).

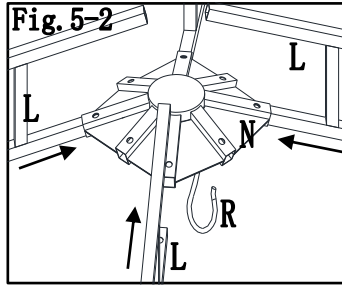

Fig.5-2: Insert slanting beam upper end(L) into large top connector(N),then attach hook(R) to top connector(N).

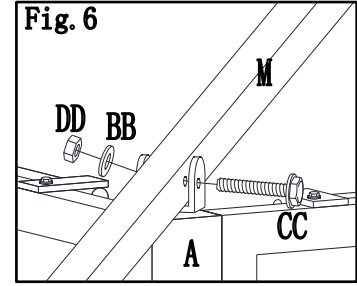

Fig.6 Attach the assembled slanting beam bottomend (M) to plate top of post(A), by using bolt(CC),washer (BB) and nut(DD).

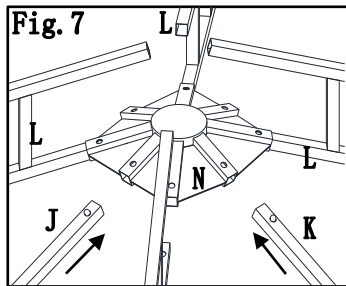

Fig.7: Attach long middle beam (J) to large top connector(N), (repeat step for short middle beam(K).

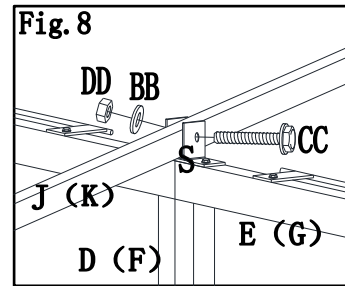

Fig.8: Attach long middle beam(J) short middle beam(K) to beam connector(S),by using bolt(CC),washer(BB),nut(DD), cover large canopy to large top frame, do not spread out.

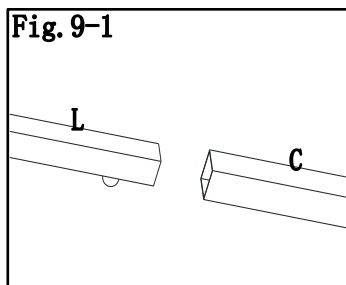

Fig.9-1: Insert adjustable tube(C) to Slanting beam(L).

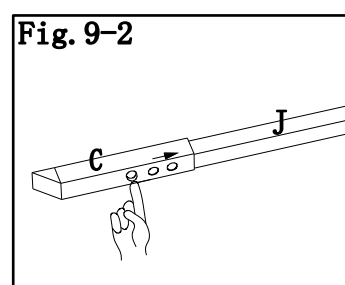





Fig.9-2: Adjust tub(C) length to shortest.

Hardware Pack 3

Description	Label	Part#	Qty	Image
Small ring	EE	P005100299	52 PCS	
Large ring	FF	P005100265	52 PCS	
Φ6*230*7"stake	GG	H070010005	24 PCS	

Step. 3

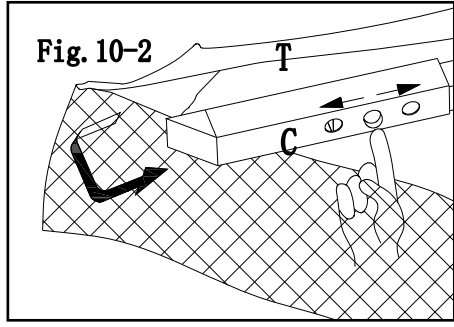
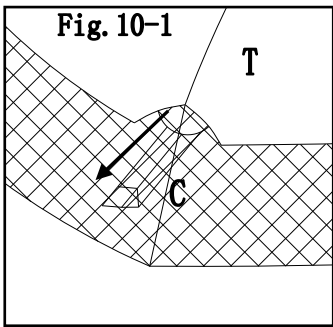
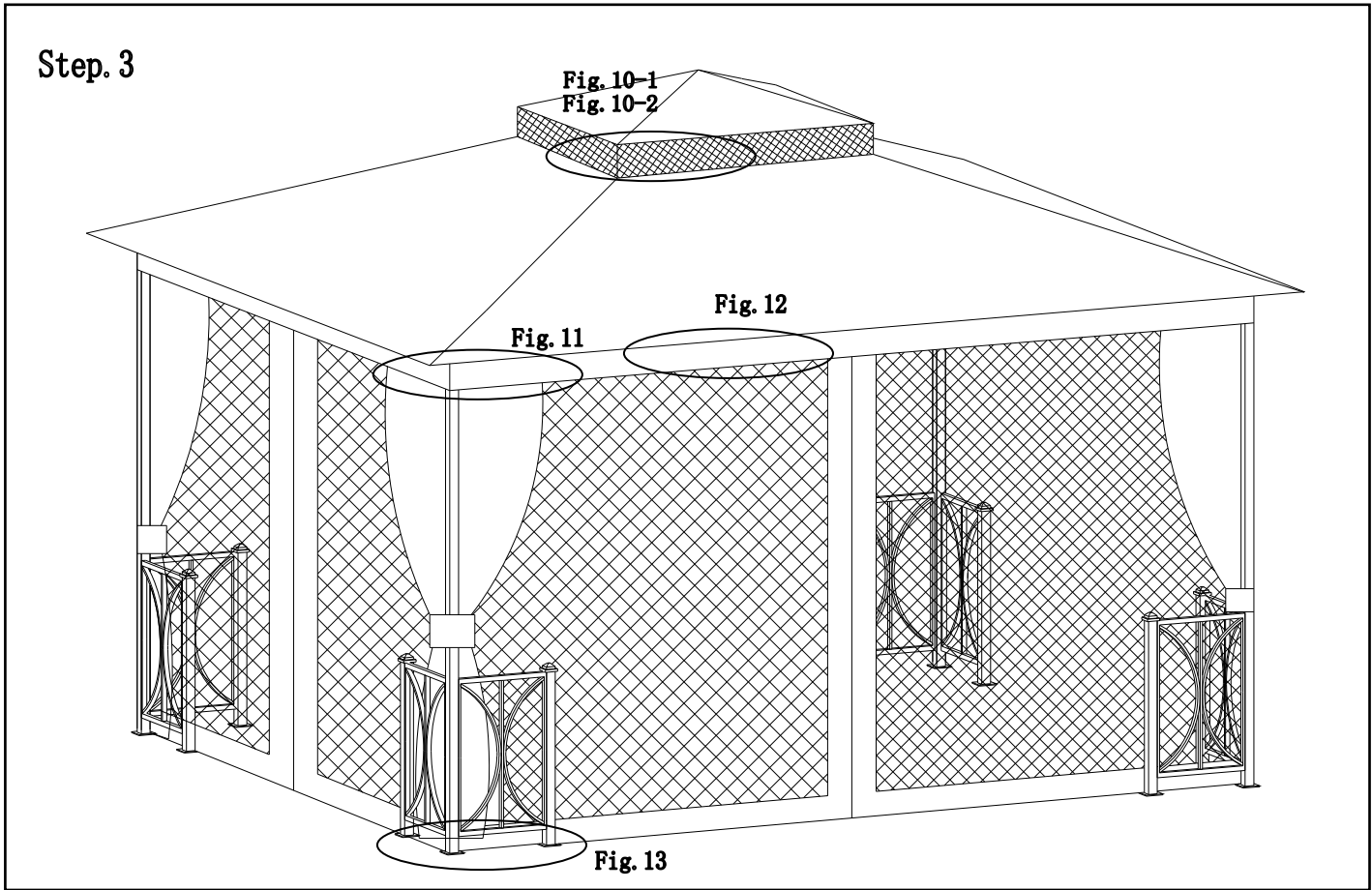

Fig.10-1:Spread small canopy(C) to small top frame.

Fig.10-2: Adjust tube length (C),till canopy tight.

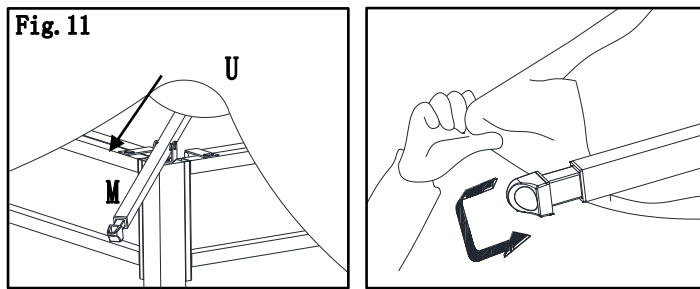

Fig.11:Spread large canopy (U) to large top frame, fix each corner to adjustable tube (C) , then adjust tube length till large canopy tight.

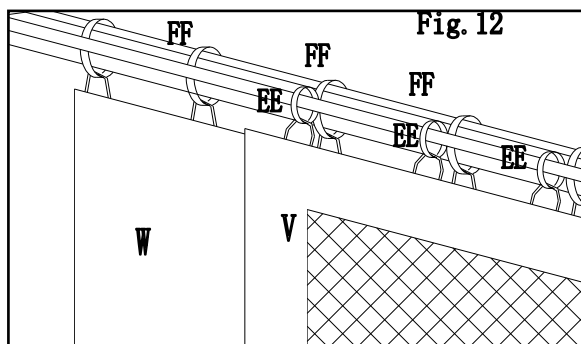

Fig.12:Using small ring (EE) hang mosquito netting (V) on netting rod (H/I). using large ring (FF) hang curtain (W) on screen upper rod(D/E/F/G).

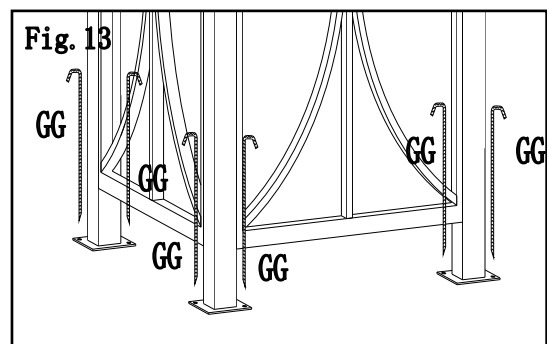

Fig.13:Fix assembled gazebo on ground, by using stake (GG) .

Care and Maintenance

- Our steel components for garden accessories and furniture are treated with rust inhibiting paint that protects it from rusting. However, due to the nature of steel, surface oxidation (rusting) will occur once these protective coatings are scratched. This is not a defect and thus not covered by the warranty.
- To minimize this condition, we recommend care when assembling & handling the product to prevent scratching the paint. Should any scratching or damage occur, we recommend immediate touch-up with rust inhibiting paint.
- Surface rust can also be easily removed with a very light application of common cooking oil. If surface oxidation (rusting) occurs and if no measure is taken to prevent this, the oxidation may start dripping on to deck or patio and caused damaging stains, which may be difficult to remove. This can be prevented if the above-mentioned measures are taken to keep the product from oxidizing.
- Use damp cloth to wipe off the stains as quickly as possible.
- If necessary, wash with a mild solution of soap and water; rinse thoroughly and dry completely.
- Periodically check and ensure that all bolts are well-tighten during use

Limited Manufacturer's Warranty

Sunjoy Group warrants to the original purchaser that this item is free from defects in workmanship and materials for a period of **1 year** from the date of purchase, provided the item was factory-sealed at the time of purchase and is maintained with care and used only for personal, residential purposes. Should any manufacturing defect arise within this warranty period, Sunjoy Group will replace (at our option) any defective merchandise or parts upon proof of purchase; however, transportation and delivery costs, as well as payments to a third party for assembly or disassembly of the item, remain the responsibility of the purchaser. A purchaser of an "open box," previously-returned, or "clearance" item, as well as original purchasers outside of the warranty period, may obtain replacement parts from Sunjoy Group for products in current production, at nominal cost.

Exclusions:

Items used for commercial, contract, or other non-residential purposes, or items damaged due to acts of nature, vandalism, misuse, or improper assembly are not covered. Corrosion or rusting of hardware is not covered. Proof of purchase (dated register receipt) is required for warranty claims. Warranty is to the original purchaser and is non-transferable. Any replacement of warranted items will be in the original style and color, or a similar style and color if the original is unavailable or has been discontinued. As some states do not allow exclusions or limitations on an implied warranty, the above exclusions and limitations may not apply. This warranty gives you specific rights, and you may also have other rights, which vary from state to state.

Country of Origin: China