

ITEM NO.:A101012100

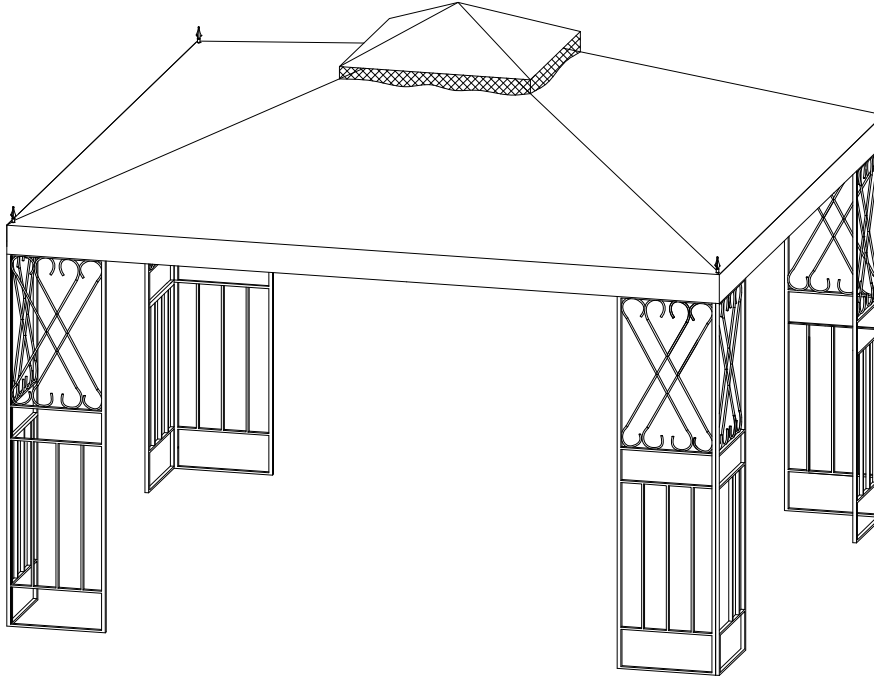

WE HAVE YOU IN MIND, LET US SERVE YOU!

Questions? Issues?

CONTACT US

24 hours / 7 days a week



www.sunjoyonline.com



customer.care@sunjoygroup.com



A10101210021

Country of Origin: China

Production Number: xxxxxxxxxxxx

Safety Information

1. **Two people** are required for this assembly.
2. Some parts may contain sharp edges. Wear protective gloves.
3. When assembling and using this product, basic safety precautions should always be followed to reduce the risk of personal injury and damage to equipment. Please read all instructions before assembly and usage.



CAUTION: Do not climb on top of the gazebo. Falling off the gazebo can result in serious injury.

NOTICE: For outdoor use

Warranty: 12 months



DANGER: This unit is heavy! Do not assemble this item alone.



WARNING: Do not leave the gazebo where there is a risk of high wind, as possible damage will occur to the structure.



WARNING: Keep all flame and heat sources away from this gazebo fabric. This Gazebo is made with fabric that meets CPAI-84 specifications for flame resistance. It is not fire proof. The fabric will burn if left in continuous contact with any flame source. The application of any foreign substance to the gazebo fabric may render the flame-resistant properties ineffective.









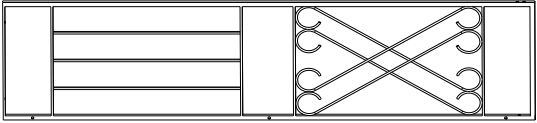
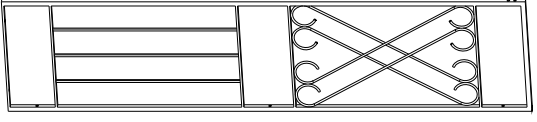

WHAT IS COVER?

The limited warranty is extended to the original purchaser and applies to material and manufacturer's defect provided the item is maintained with care and used only for personal, residential purposes.

IMPORTANT

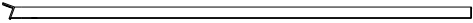
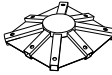
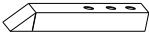
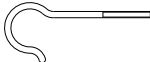
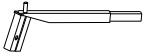



Country of Origin: China

Parts List

Description	Label	Part#	Qty	Image
Screen 1	A	P006300073	4	
Screen 2	B	P006300074	4	
Short across beam	C	P000400868	2	
Long across beam 1	D	P000400870	2	
Long across beam 2	E	P000400869	2	
Slanting beam upper tube	F	P000601308	4	
Middle beam (Long)	G	P000601309	2	
Middle beam (Short)	H	P000601310	2	
Big top connector	J	P000501141	1	
Adjust tube	K	P005700643	4	
Hook	L	P005800001	1	
Connector for Slanting Beam 1	M	P000501142	2	
Connector for Slanting Beam 2	N	P000501173	2	
Finial	P	P005600298	4	
Big canopy	Q	P001100524	1	
Small canopy	R	P001100525	1	

Country of Origin: China

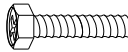
Hardware Pack 1

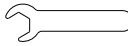
Label	Description	Part#	Qty	Image
AA	M6X15 Bolt	H010020011	4PCS	
BB	M6 flat washer	H050030001	48PCS	
CC	M6X30 Bolt	H010020023	28PCS	
DD	M6 nut	H040010004	16 PCS	
W1	M6 Wrench	H090010017	2 PCS	

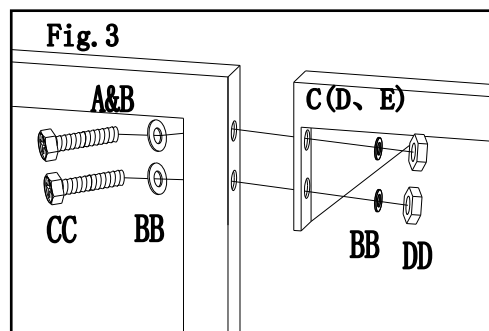
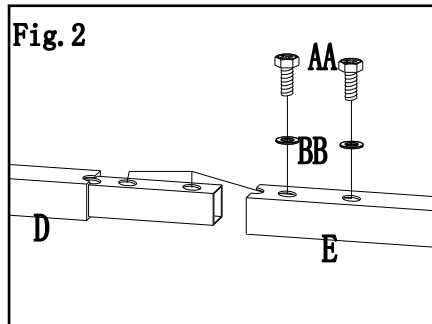
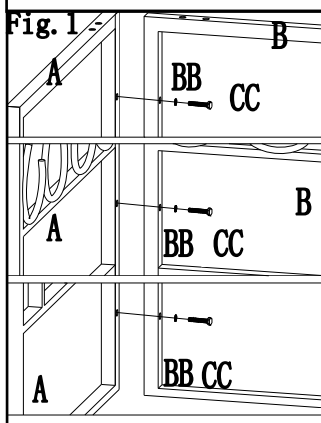
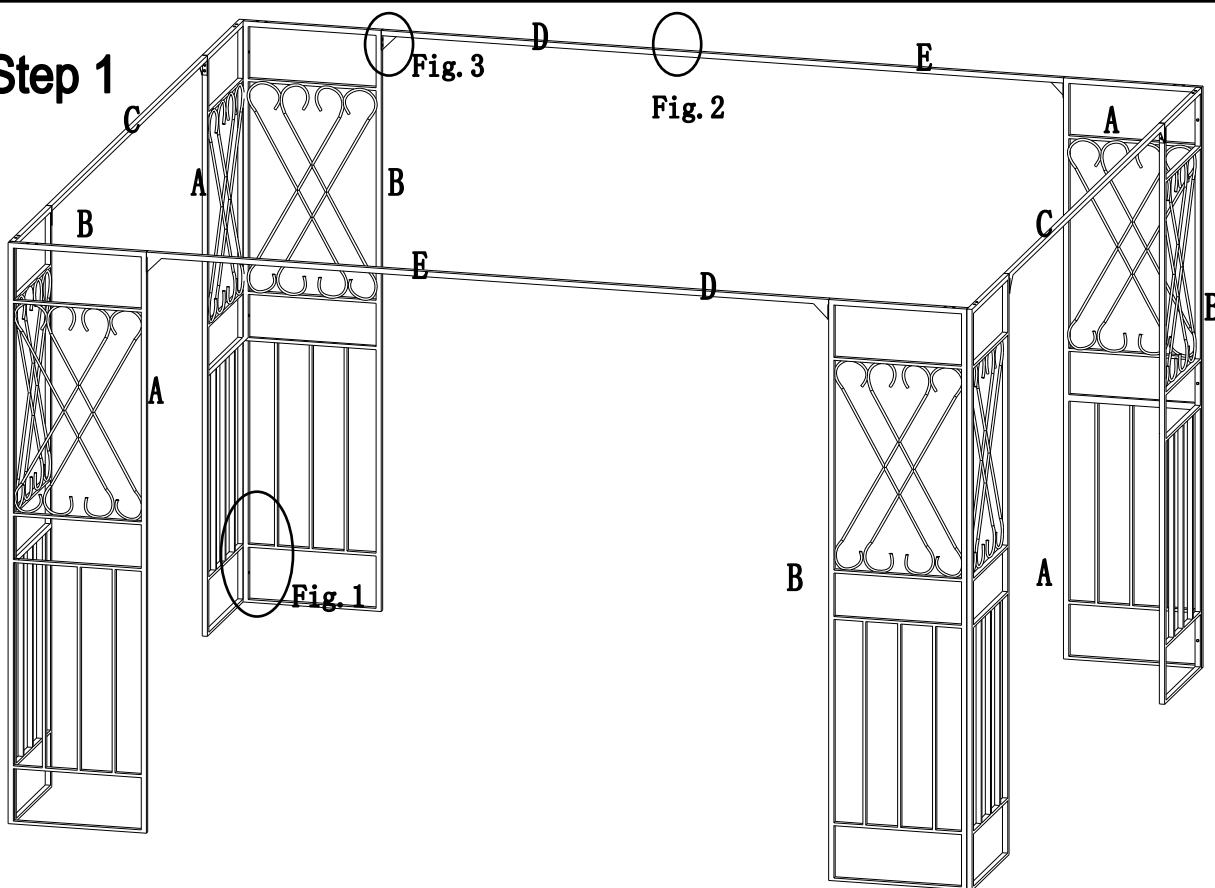

Step 1



Country of Origin: China

- Fig.1:** Attach screen1 (A) to screen2 (B), then fix by using Bolt (CC) and Flat washer (BB) .
- Fig.2:** Insert Long across beam 1(D) into Long across beam 2(E) then fix by using Bolt (AA) and Flat washer (BB) .
- Fig.3:** Attach the across beam (C/D/E) to screen (A/B) fix by using Bolt (CC) and Flat washer (BB) nut (DD), form the whole framework.

Hardware Pack 2

Label	Description	Part#	Qty	Image
BB	M6 flat washer	H050030001	4PCS	
AA	M6X15 Bolt	H010020011	4 PCS	

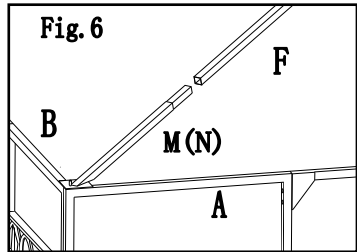
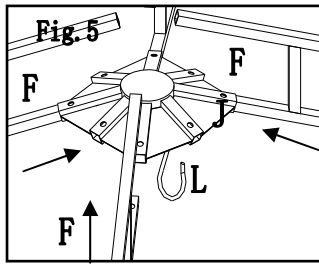
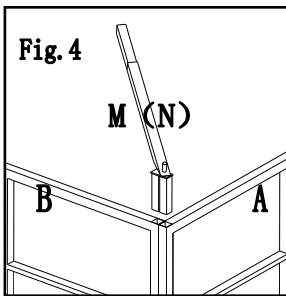
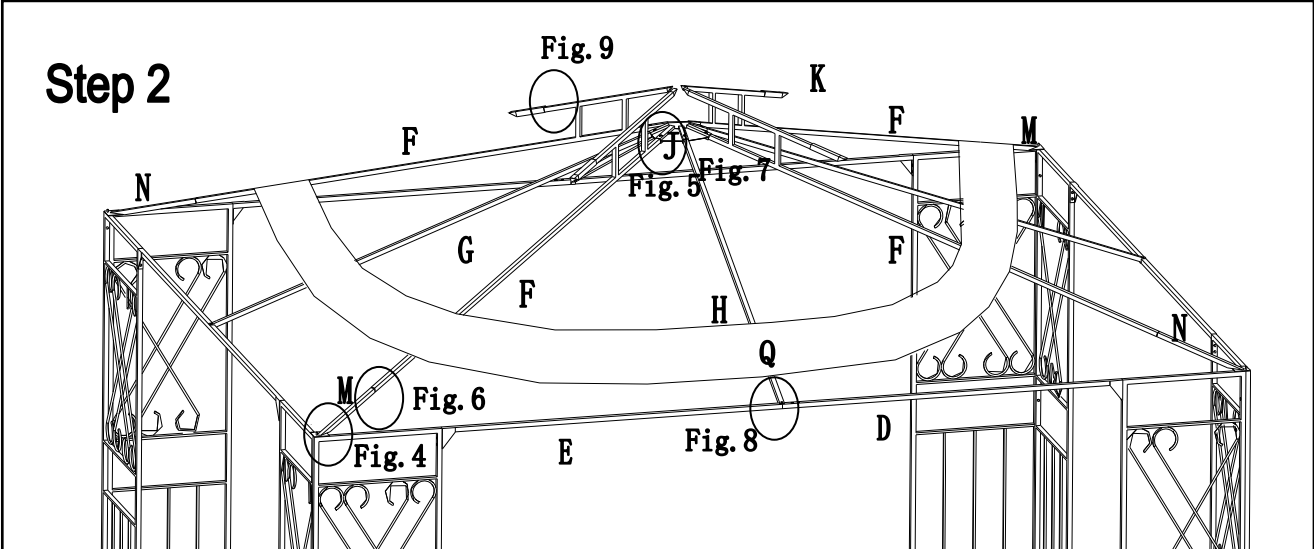

- Fig.4:** Insert Connector for Slanting Beam(M/N) to screen (A/B) .
- Fig.5:** Insert Slanting beam upper tube(F) to Big top connector(J).
- Fig.6:** Insert Slanting beam upper tube(F) to Connector for Slanting Beam(M/N).

Country of Origin: China

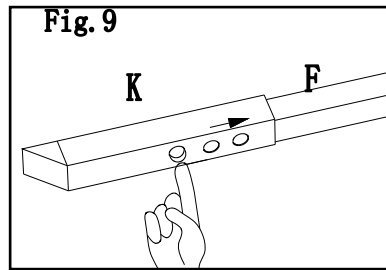
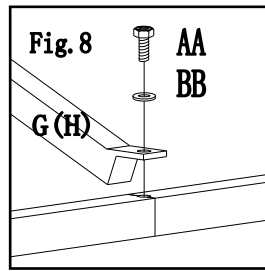
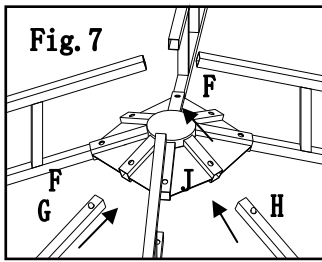

Fig.7: Insert Middle beam(G/H) to Big top connector(J).

Fig.8: Attach Connector for Slanting Beam(G/H)to across beam fix by using Bolt(AA)and Flat washer (BB) .then Put big canopy (Q) on big top frame(Do not fasten corner)。。

Fig.9: Insert Adjust tube(K) to Slanting beam upper tube(F), then Adjust the Adjust tube(K) to the minimum.

Hardware Pack 3

Label	Description	Part#	Qty	Image
FF	∅ 6*230	H070010005	16 PCS	

Step 3

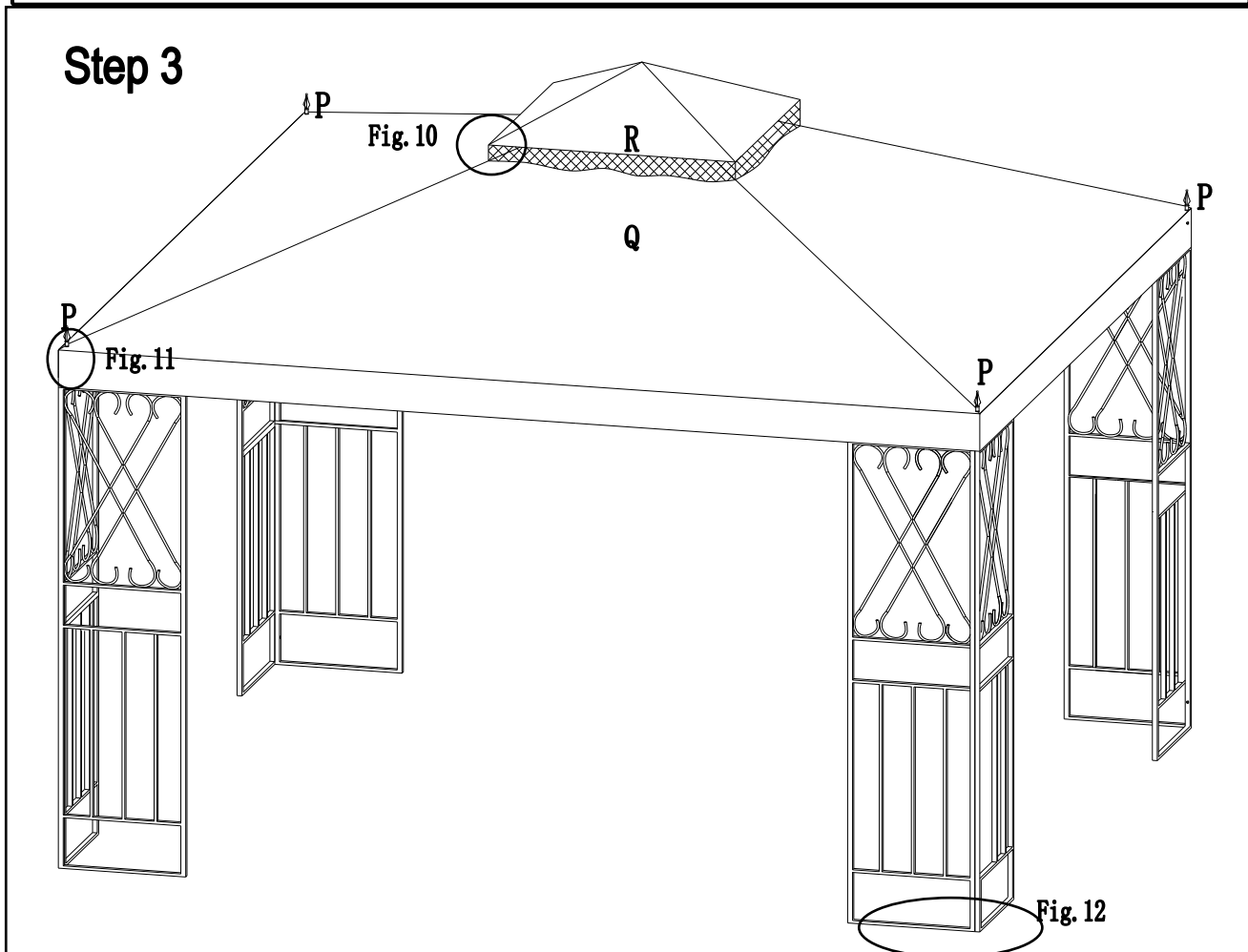

Country of Origin: China

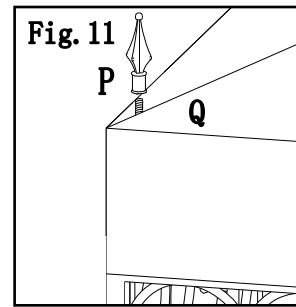
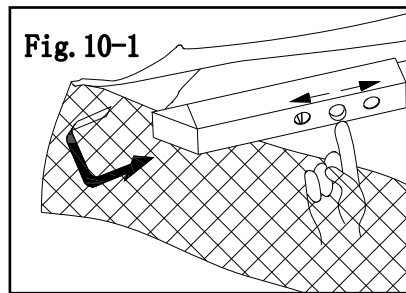
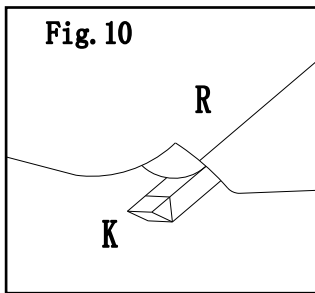

Fig.10: Put small canopy (R) on small top frame. Fix small canopy four corner to adjustable tube, then adjust the tube to right position until small canopy tight.

Fig.11: Fix big canopy four corner then Attach Finial(P) to the top.

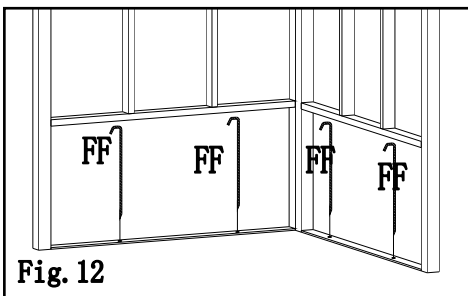

Fig.12: by using stake “7” (FF) fix assembled gazebo on ground.

Care and Maintenance

- Our steel components for garden accessories and furniture are treated with rust inhibiting paint that protects it from rusting. However, due to the nature of steel, surface oxidation (rusting) will occur once these protective coatings are scratched. This is not a defect and thus not covered by the warranty.
- To minimize this condition, we recommend care when assembling & handling the product to prevent scratching the paint. Should any scratching or damage occur, we recommend immediate touch-up with rust inhibiting paint.
- Surface rust can also be easily removed with a very light application of common cooking oil. If surface oxidation (rusting) occurs and if no measure is taken to prevent this, the oxidation may start dripping on to deck or patio and caused damaging stains, which may be difficult to remove. This can be prevented if the above-mentioned measures are taken to keep the product from oxidizing.
- Use damp cloth to wipe off the stains as quickly as possible.
- If necessary, wash with a mild solution of soap and water; rinse thoroughly and dry completely.
- Periodically check and ensure that all bolts are well-tighten during use

Limited Manufacturer's Warranty

Sunjoy Group warrants to the original purchaser that this item is free from defects in workmanship and materials for a period of 12 months from the date of purchase, provided the item was factory-sealed at the time of purchase and is maintained with care and used only for personal, residential purposes. Should any manufacturing defect arise within this warranty period, Sunjoy Group will replace (at our option) any defective merchandise or parts upon proof of purchase; however, transportation and delivery costs, as well as payments to a third party for assembly or disassembly of the item, remain the responsibility of the purchaser. A purchaser of an "open box," previously-returned, or "clearance" item, as well as original purchasers outside of the warranty period, may obtain replacement parts from Sunjoy Group for products in current production, at nominal cost.

Exclusions:

Items used for commercial, contract, or other non-residential purposes, or items damaged due to acts of nature, vandalism, misuse, or improper assembly are not covered. Corrosion or rusting of hardware is not covered. Proof of purchase (dated register receipt) is required for warranty claims. Warranty is to the original purchaser and is non-transferable. Any replacement of warranted items will be in the original style and color, or a similar style and color if the original is unavailable or has been discontinued. As some states do not allow exclusions or limitations on an implied warranty, the above exclusions and limitations may not apply. This warranty gives you specific rights, and you may also have other rights, which vary from state to state.

Country of Origin: China