

Dimensions are Metric

Do not mix ceramic, plastic, and teflon insulators

Wide Version
Usually used with Ceramic Insulators

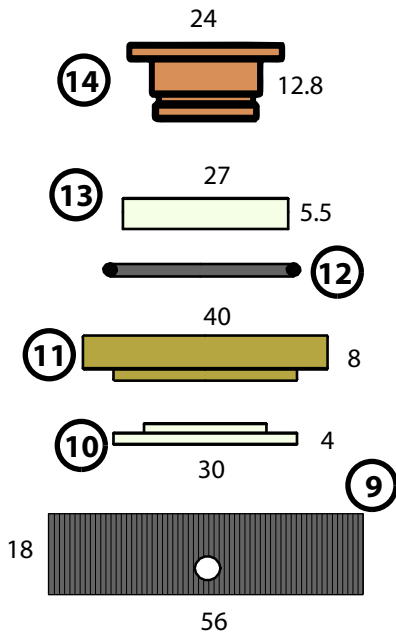

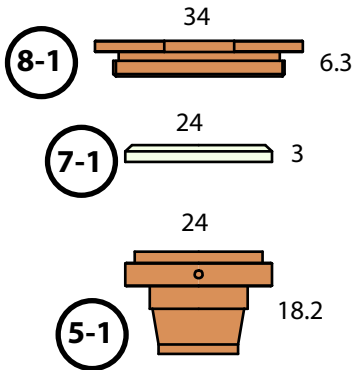

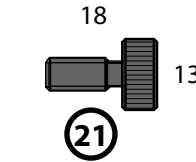
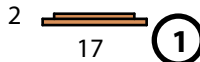
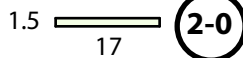
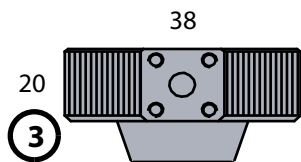
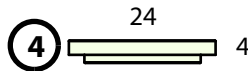
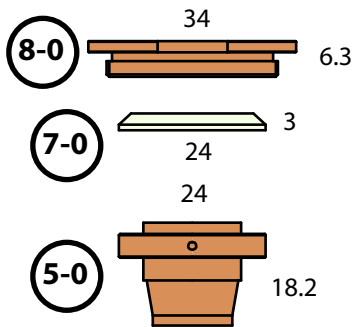



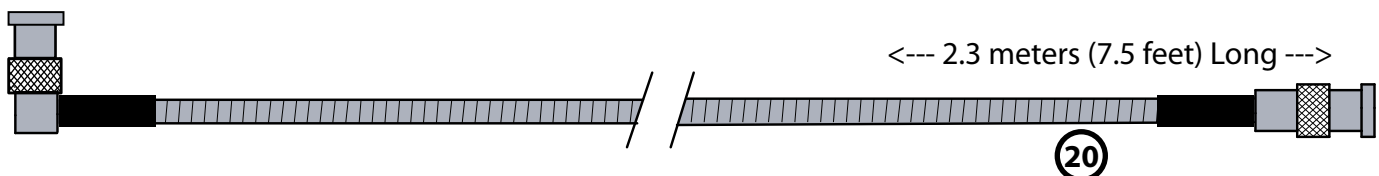
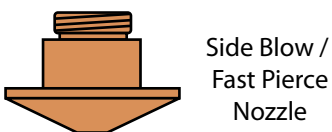
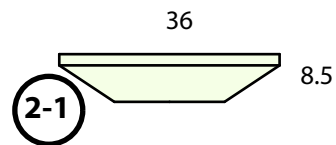
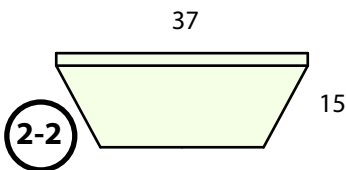
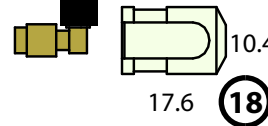
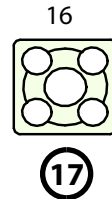
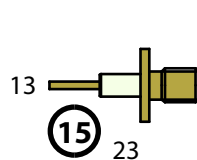
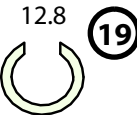
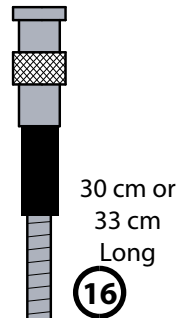

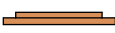
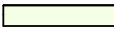



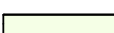
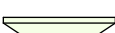
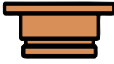
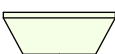

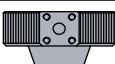



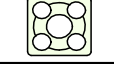

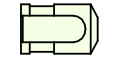









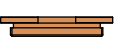

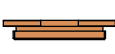



Narrow Version



Custom Cables Available



1		M101U0	Copper Ring 17x2	13 C		M113C0	Isolation Ring Ceramic 27x5.5
2-0		M102T0	Teflon Spacer 17x1.5	13 P		M113P0	Isolation Ring Plastic 27x5.5
2-1 P		M102P1	Nozzle Cover: Plastic	13 T		M113T0	Isolation Ring Teflon 27x5.5
2-1 T		M102T1	Nozzle Cover: Teflon	14		M114U0	Central Copper Body
2-2		M102T2	Side Blow Nozzle Cover: Teflon	15		M115B0	Connector Assembly
3		M103A0	Aluminum Body	16-30		M116S0	Sensor Cable 30cm
4 C		M104C0	Isolation Ring Ceramic 24x4	16-33		M116S1	Sensor Cable 33cm
4 P		M104P0	Isolation Ring Plastic 24x4	17		M117T0	Connector Cover Teflon
4 T		M104T0	Isolation Ring Teflon 24x4	18		M118T0	Cable Connector Cover Teflon
5-0		M105U0	Nozzle Holder Narrow Top	19		M119T0	Cover Clip Teflon
5-1		M105U1	Nozzle Holder Wide Top	20		M120S0	Long Sensor Cable
6		M106S0	Set Screw	Nozzles: The last two digits of the part number indicate the nozzle orifice diameter: 10 = 1.0mm, 15 = 1.5mm, 20 = 2.0mm, etc...			
7-0 C		M107C0	Isolation Ring Ceramic 24x3 Narrow				
7-0 P		M107P0	Isolation Ring Plastic 24x3 Narrow				
7-0 T		M107T0	Isolation Ring Teflon 24x3 Narrow				
7-1 C		M107C1	Isolation Ring Ceramic 24x3 Wide		MN10XX	Nozzle: Narrow (10 Pack)	
8-0		M108U0	Copper Nut Narrow Bottom		MN11XX	Nozzle: Wide (10 Pack)	
8-1		M108U1	Copper Nut Wide Bottom		MN12XX	Nozzle: Wide Chrome Plated (10 Pack)	
9		M109S0	Ring H18		MN14XX	Nozzle: Wide Chrome Plated Double (10 Pack)	
10 C		M110C0	Isolation Ring Ceramic 30x4		MN15XX	Side Blow / Fast Pierce Nozzle	
10 P		M107P0	Isolation Ring Plastic 30x4		MN16XX	Side Blow / Fast Pierce Nozzle Chrome Plated	
10 T		M110T0	Isolation Ring Teflon 30x4		MN18XX	Side Blow / Fast Pierce Nozzle Chrome Plated Double	
11		M111B0	Brass Bass				
12		M112G0	O-ring External Base				