

# Projecteur au LED FL-07-G9



## Meilleure solution pour projecteur au LED



Hydrofuge IP66



Installation facile



AC100-277V 50/60Hz  
AC277-480V  
130Lm/W  
150Lm/W

Temp. opération: -40°C ~ +50°C Temp. entreposage: -40°C ~ +80°C



## Options

Alimentation	CCT	Couleur boîtier	Beam Angle
INVENTRONICS DRIVER	3000K	Black+Red	15°
	4000K	Black+Blue	30°
	5000K	Black+Green	45°
	5700K	Black+Black	80°
		Grey+Grey	

## Applications

Éclairage pour stades, aires de sport, stationnements, installations en hauteur, gares et terminaux ferroviaires, ports et autres applications d'extérieur à grande échelle. Éclairage d'architecture, de paysage, d'applications industriels et commerciaux. Éclairage décoratif pour fêtes, conventions et exhibitions.

## Spécifications

Item	Puissance	Efficacité	Leds	CRI	Poids	Beam Angle
FL300W-07-G9	300W	130Lm/W 150Lm/W	SAMSUNG 3535 SMD5050	>70	17.2kg(37.9lbs)	15° 30°/45°/80°
FL400W-07-G9	400W	130Lm/W 150Lm/W	SAMSUNG 3535 SMD5050	>70	17.2kg(37.9lbs)	15° 30°/45°/80°
FL500W-07-G9	500W	130Lm/W 150Lm/W	SAMSUNG 3535 SMD5050	>70	17.2kg(37.9lbs)	15° 30°/45°/80°
FL600W-07-G9	600W	150Lm/W	SMD5050	>70	18.2kg(40.1lbs)	30°/45°/80°
FL700W-07-G9	700W	130Lm/W 150Lm/W	SAMSUNG 3535 SMD5050	>70	28.7kg(63.3lbs)	15° 30°/45°/80°
FL800W-07-G9	800W	130Lm/W 150Lm/W	SAMSUNG 3535 SMD5050	>70	28.7kg(63.3lbs)	15° 30°/45°/80°
FL1000W-07-G9	1000W	130Lm/W 150Lm/W	SAMSUNG 3535 SMD5050	>70	28.7kg(63.3lbs)	15° 30°/45°/80°
FL1200W-07-G9	1200W	150Lm/W	SMD5050	>70	28.7kg(63.3lbs)	30°/45°/80°

## Dimensions(mm)

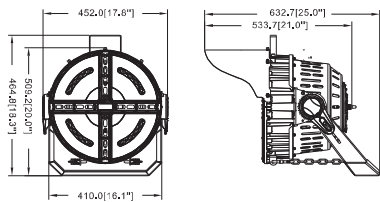

300W/400W/500W/600W

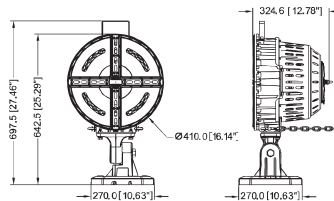

300W/400W/500W/600W

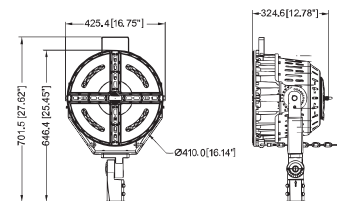

300W/400W/500W/600W

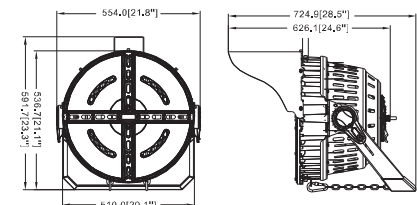

700W/800W/1000W

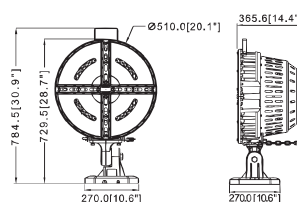

700W/800W/1000W

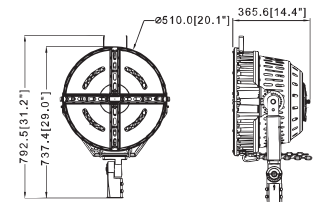

700W/800W/1000W

# FL-07-G9

## Options de modèle



## Photométrie

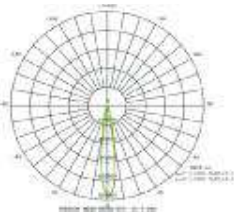

15°

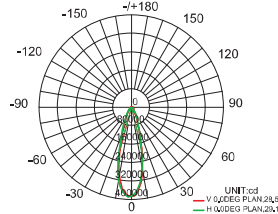

30°

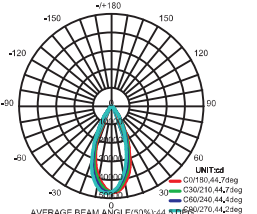

45°

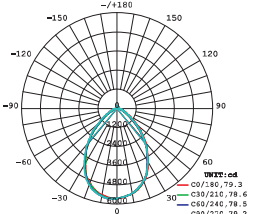

80°

## Installation et utilisation

### P1 Support en U

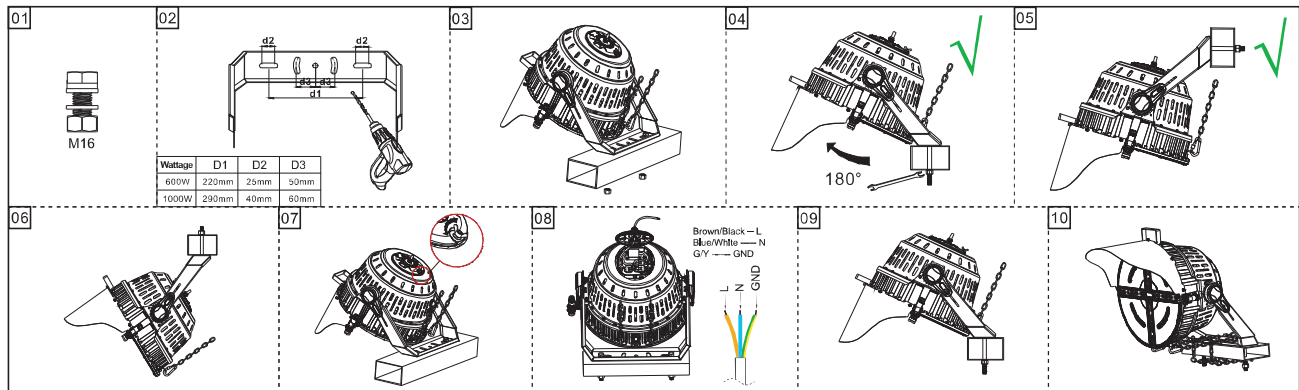

### P2 Support rotatif

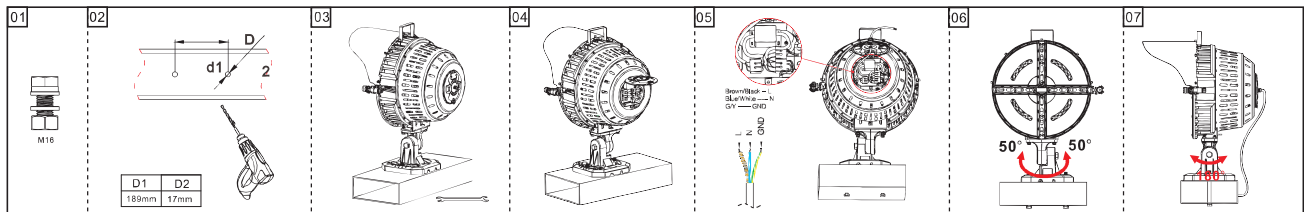

### P3 Support par insertion ("Slip fitter")

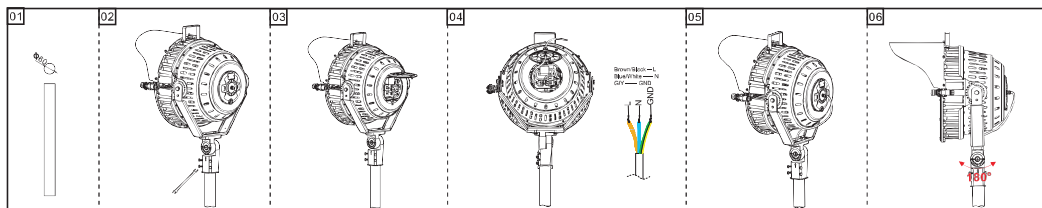

# FL-07-G9

## P4 Support en poteau

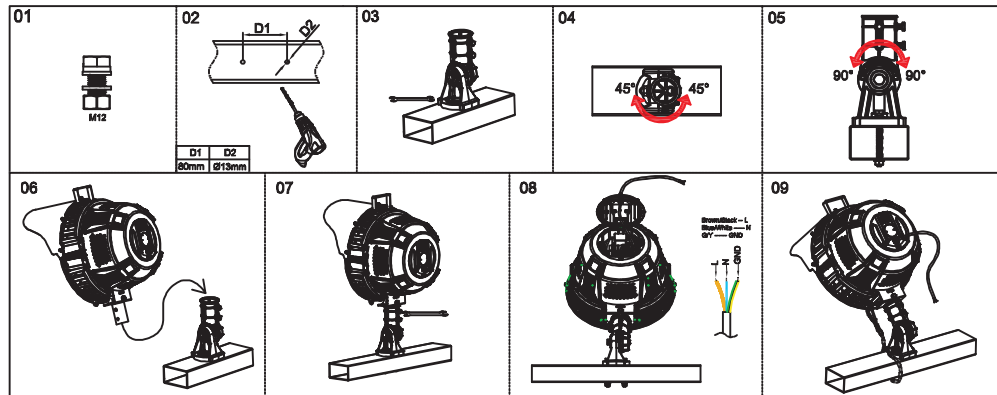

## P7 Slip Fitter (Installation séparée)

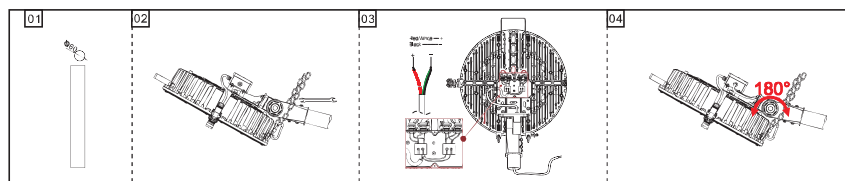

## P8 Support rotatif (Installation séparée)

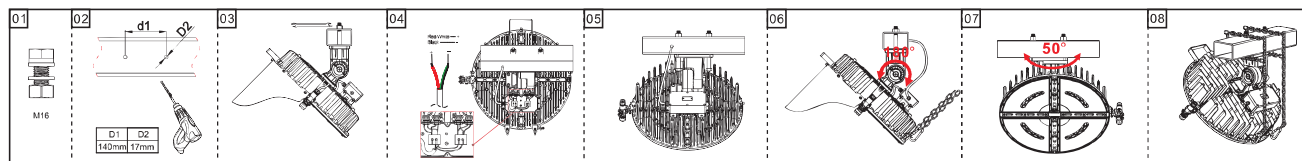

## Spécifications d'emballage

Item	Boîte			Mesures (mm)	Poids	Mcx/boîte
	Mesures (mm)	Poids	Mcx/boîte			
FL300W/400W/500W/600W-07-G9-P1P3	635L*525W*385H	21,80kg (48,06lbs)	1	/	/	/
FL700W/800W/1000W-07-G9-P1P3	745L*615W*450H	32,34kg (71,30lbs)	1	/	/	/
FL300W/400W/500W/600W-07-G9-P2/P4	735L*525W*385H	24,7kg(54,5lbs)	1	/	/	/
FL700W/800W/1000W-07-G9-P2/P4	825L*615W*450H	34kg(75,0lbs)	1	/	/	/