

Installer Instructions

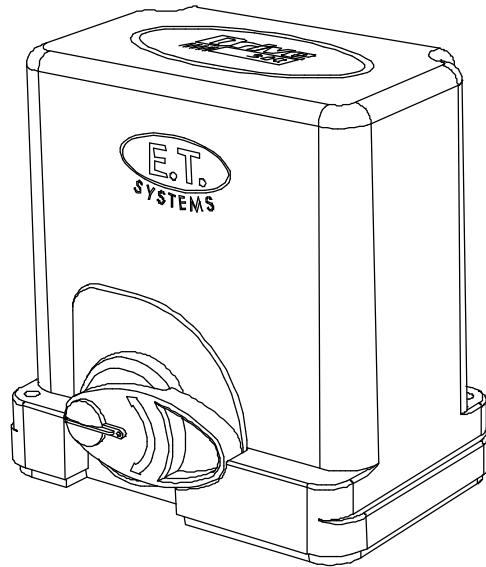

Low traffic 300kg Slide Gate Operator



a company of TheNiceGroup



Introduction.	
Page 3	Be Safe! Instructions, warnings and obligations.
Page 4	Technical specifications.
Page 5	Component identification and operator dimensions.
Site preparation.	
Page 6	Gate preparation and mechanical requirements.
Page 7	Duty cycle.
Page 7	Motor positioning.
Page 8	Cabling requirements.
Hardware installation - Mechanical.	
Page 9	Baseplate kit and installing the baseplate.
Page 10	Cable conduit height above baseplate.
Page 10	How to use the manual release override.
Page 11	Mounting the motor onto the baseplate.
Page 12	Installing the rack.
Hardware installation - Electrical.	
Page 14	Terminating the AC supply.
Page 15	Wiring and termination of the control card.
Page 16	Installing the limit actuator.
Control card programming and setup.	
Page 17	Using the control card display and dashboard.
Page 18	Programming menu quick reference guide.
Page 19	Setting up the gate runtime.
Page 20	Selecting a safety level.
Page 20	Safety infra-red beams setup.
Page 21	Selecting a BT operating mode and adjusting the BT auto-close time.
Page 22	Setting up the pedestrian open distance and pedestrian auto-close time.
Page 23	Receiver programming and setup.
Page 29	Switching the AC monitoring and/or built-in charger on or off.
Page 30	Adjusting the length of the slow speed at the ends of travel.
Page 30	Switching the positive close mode on or off.
Page 31	Selecting the Auxiliary relay's mode of operation.
Operating mode definitions and examples.	
Page 32	Collision sensing and safety overload routines
Page 33	Safety infra-red beams function. All modes except P.I.R.A.C. auto-close mode.
Page 34	"BT" Button triggers - Standard mode.
Page 35	"BT" Button triggers - Simple auto-close mode.
Page 36	"BT" Button triggers - Condominium auto-close mode.
Page 37	"BT" Button triggers - P.I.R.A.C. auto-close mode.
Page 38	"PED" Pedestrian trigger. With no safety beams installed.
Page 39	"PED" Pedestrian trigger. With safety beams installed.
Page 40	Auxiliary relay modes - Strike lock mode.
Page 41	Auxiliary relay modes - Magnetic lock mode.
Page 42	Auxiliary relay modes - Receiver relay mode.
Page 43	Auxiliary relay modes - Courtesy light mode.
Page 44	Auxiliary relay modes - Alarm mode.
Page 45	Positive close mode.
Page 46	Holiday lock-out mode.
Page 47	Auto-close override/party mode.
Troubleshooting.	
Page 48	Status LED, buzzer and diagnostics menu definitions.
Page 49	Troubleshooting guide and display definitions.
Page 50	Warranty.

Be Safe!

WARNING!! These are the general safety obligations for the installers and users of ET Systems automation equipment. A copy of this document also appears in the user instructions. Those instructions must be issued to the responsible end user during the handover and instruction meeting.

1. Only suitably qualified persons, may install, repair or service the product. Unless expressly indicated in the user instructions, no user serviceable components can be found inside any ET Systems automation product.
2. It is important for personal safety to study and follow all the instructions carefully. Incorrect installation or misuse may cause serious personal harm.
3. Keep the instructions in a safe place for future reference.
4. This product was designed and manufactured, strictly for the use indicated in the accompanying documentation. Any other use not expressly indicated in the documentation, may damage the product and/or be a source of danger. ET Systems cannot accept responsibility for improper use or incorrect installation of this product.
5. ET Systems cannot accept responsibility if the principles of good workmanship are disregarded by the installer.
6. ET Systems cannot accept responsibility regarding safety and correct operation of the automation, if other manufacturers' equipment is added to this product.
7. Do not make any modifications or alterations to this product. Do not substitute any component of this product with any other component not expressly designed into this product.
8. Anything other than expressly provided for in the accompanying instructions is not permitted.

Prior to installation:

1. All unnecessary ropes, chains and fasteners must be removed and all unnecessary latches or locks must be disabled from locking.
2. The gate or door must be balanced correctly where it, neither opens nor closes from any position under its own load. When operated by hand the gate or door should be free of hindrance and easily moved (In the case of a garage door if the balancing springs need to be adjusted the adjustment should only be carried out by a qualified and experienced person).
3. The construction of the gate or door must be sound and automatable. It is the responsibility of the installer to ensure that the mechanical components of the gate or door system are sufficient to withstand the necessary forces in cases of overload.
4. It is the responsibility of the installer to ensure the gate or door is sufficiently trapped within its range of travel by means of mechanical ends of travel stoppers.
5. Ensure all fixed mounting points, such as the wall above the door in a garage door system or the posts in a swing gate system, are sound and strong enough to allow proper fixing of the operator.
6. It is the responsibility of the installer to ensure the installed position selected for this product, falls within the limitations of the products ingress protection rating.
7. Ensure the area of installation is not subject to explosive hazards. There should be no volatile gasses or fumes as these can present a serious safety hazard.
8. All ET Systems garage door operators are supplied with a sealed 15A safety plug on lead for use in an electrical code of practice approved plug point. Do not extend, modify or replace the plug lead unless duly qualified as an electrician. Before installing the unit, ensure the mains supply is switched off.
9. ET Systems gate operators are supplied with a terminal connection for the electrical supply beneath the screwed down cover of the operator. In the case of a model requiring 220Vac supply at the operator, an all pole negatively biased switch, with a contact opening of greater than 3mm must be installed within 1,5m of the operator. This switch must be clear of all workings of the system and must be in a position secure from public access. This switch and its connections must be inspected and passed by a certified electrician prior to using it.
10. It is the responsibility of the installer to ascertain that the designated persons (including children) intended to use the system, do not suffer reduced physical sensory or mental capabilities, or lack of experience and knowledge, unless they have been given supervision or instruction concerning the use of the system by a person responsible for their safety.
11. The drive may not be installed on a door incorporating a wicket door, unless the drive is disabled by the release of the wicket door. (Wicket door :- A pedestrian door within the main gate or door)

During installation:

1. Ensure the working area is clear of obstructions and obstacles.
2. Install the safety warning sticker within clear view of where the gate or door will be operated from. Typically this would be adjacent to any fixed trigger switches or on the gate or door itself.
3. The emergency manual release must be installed where it is no higher than 1,8m from the floor level. This would apply to the cord in a garage installation or the lockable lever in a gate installation.
4. Any additional fixed door control switches such as wall consoles or keypads, if installed, must be at a height of at least 1,5m, within clear sight of the gate or door and away from any moving components of the system.

Continued overleaf.....

5. It is highly recommended that a set of safety infra-red beams be used in conjunction with this product. The safety beams must be installed in such a way that the product is prevented from running when anything is in the path of the door or gate.
6. Over and above the recommendation to use safety infra-red beams with this product it is mandatory to install and use a safety beam set when using the automatic closing feature. It is recommended that a warning light be fitted to any automation system.
7. The emergency manual release instruction label must be installed on or adjacent to the emergency manual release mechanism.

After installation - It is the responsibility of the installer to ensure the users:

1. Is proficient in the use of the manual emergency release mechanism.
2. Is issued with the documentation accompanying this product.
3. Understands that the gate or door may not be operated out of clear sight.
4. Ensures that children are kept clear of the gate or door area at all times, and that children do not play with the remote transmitters or any fixed trigger switches linked to the system.
5. Is instructed not to attempt to repair or adjust the automation system and to be aware of the danger of continuing to use the automation system in an unsafe condition before a service provider attends to it.
6. Is proficient in testing the unit's safety obstruction sensing system.
7. Is aware of what to check for with regards to wear and tear that may need to be attended to from time to time by the service provider.
8. Is aware that a fatigued battery may not be disposed of in the general refuse and must be handed in at a battery merchant for safe disposal. Before removing the battery from the system the household mains must be disconnected. In the case of the motor unit being removed and scrapped, the battery must be removed first.

Technical specifications.

Rated gate mass.	300kg
Maximum gate leaf length.	25m
Primary power supply to gate.	220 – 240Vac @ 50Hz – 60Hz (A low voltage plug-in transformer can be purchased and installed if required)
Peak power consumption at gate	18W
Electrical class.	Class 1 
Motor voltage.	24Vdc
Motor current limiting.	5A Starting / 3,5A Running
Rated duty cycle.	25% with 220Vac present (See determining your duty cycle on page 7)
Number of operations on battery reserve within 24 hours of power failure.	100 (Gate load and battery health dependent. Based on a gate opening of 4m)
Gate speed.	25m/min (Gate load and battery health dependent)
Rated Load.	300N Starting / 240N Running
Operating temperature range.	-10 to 50° C (14F to 122F)
Anti-crushing safety sensing.	Yes – Electronic gate profiling
Auxiliary supply output.	12Vdc @ 400mA
Built in battery charger.	Multiple stage auto-calibrating (350mA peak)
Receiver format.	ET BLU MIX ® Backward compatible with ET BLUE (Rolling code)
Receiver frequency.	433.92MHz
Receiver channels.	4CH (BT, PED, Aux relay, Holiday lock-out)
Receiver memory capacity.	32 users
All users can be allowed control of all channels.	Yes
Ingress protection.	IPX4

Component identification and descriptions.

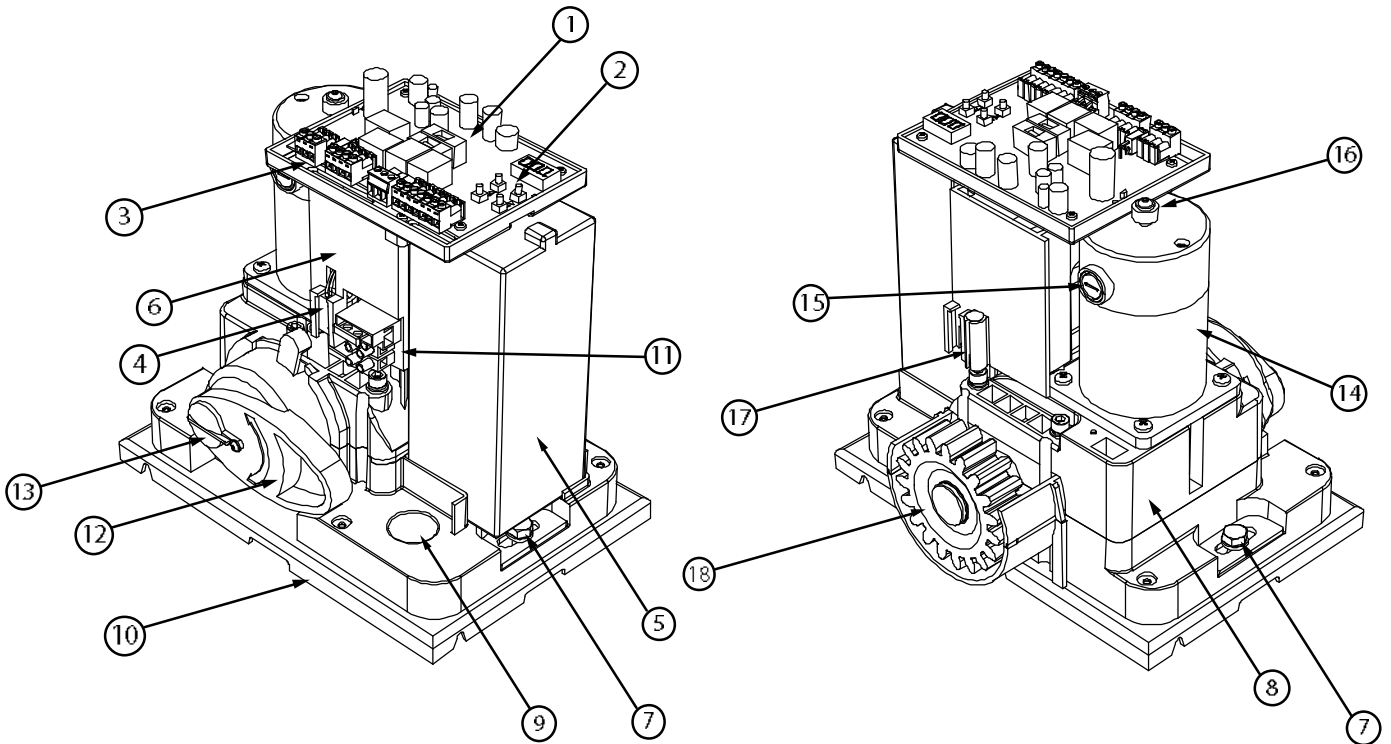
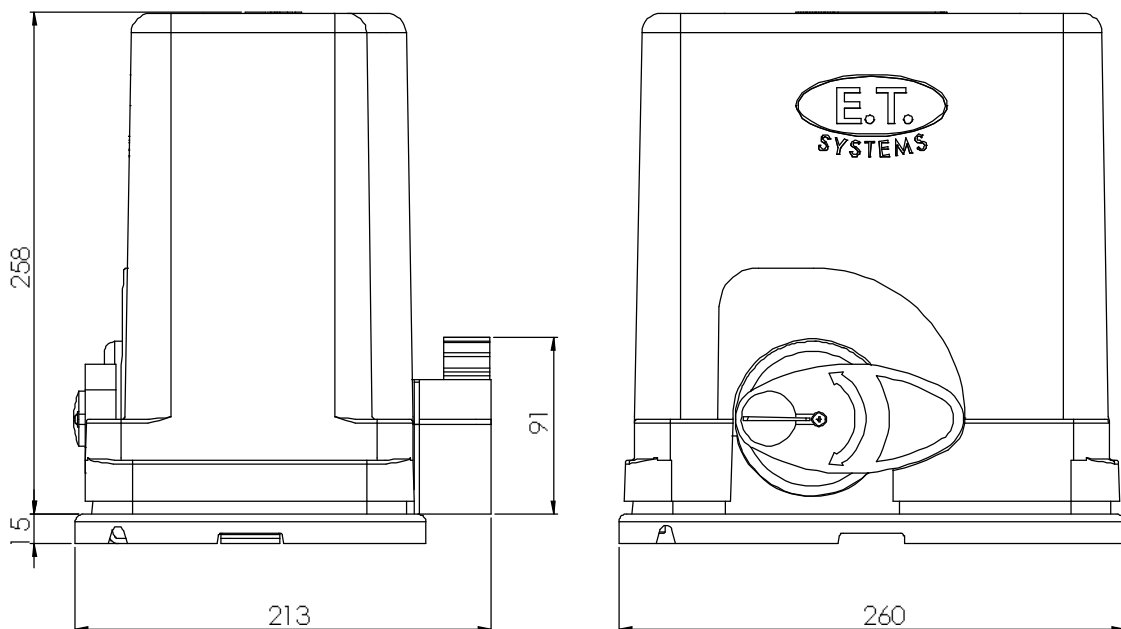

Diagram number	Description	Diagram number	Description
1	Control card	10	Baseplate
2	Dashboard	11	220V connector
3	Plug-in terminal connectors	12	Manual release
4	Manual release monitoring reed switch	13	Manual release lock
5	Battery	14	Electric motor
6	Transformer housing	15	Electric motor brush ports
7	Mounting bolts	16	Revolution counter ring magnet
8	Gearbox	17	Ends of travel limits, reed switch
9	Cable inlets	18	Output drive pinion

Operator dimensions.



Gate preparation and mechanical requirements.

BEFORE ATTEMPTING TO INSTALL A SLIDE GATE OPERATOR, PLEASE BE CERTAIN YOU HAVE READ AND UNDERSTOOD THE FOLLOWING TO ENSURE CONTINUED SATISFACTORY SAFE SERVICE FROM THIS PRODUCT:

The following are points to note before installing your new slide gate operator:

1. Gate mechanics.
2. Duty cycle.
3. Where to position the gate motor with regards to ingress protection.
4. Cabling requirements.

Gate mechanics.

Gate Leaf:

Gate leaf must be sound and of sufficient construction to accommodate an operator of this type (see technical specifications). Gate leaf should be straight and true with minimal deviation to the fascia that the rack must attach to (no 'banana-effect').

Wheels and track:

The track must be secure, straight, level and free of all obstructions.

Recommended wheel type and size for this automation is steel or steel alloy, machined or cast wheels of at least 100mm diameter using sealed roller bearings. The larger the wheel the less rolling resistance generated. Larger wheels also maintain their plumb and momentum longer. When wheels are fixed in the gate, and not able to pivot, binding can occur if the gate is bowed. (Banana effect) For wheel profile and matching track types, see the three examples below:

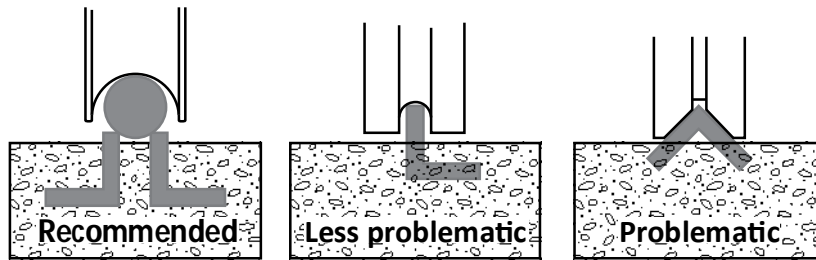

Guides:

- It is recommended that a roller guide consisting of a sealed roller bearing clad in nylon be used.
- The guidance system should be installed at the top edge of the gate whenever possible. In cases where this is not possible the guidance system should never be below the halfway point of the total gate height when the gate is in position on its track.
- In the case of a single guide roller running in a guide channel, ensure the guide never touches both inside walls of the channel simultaneously. This causes the roller to snag as it tries to roll in both directions at once.
- In the case of 2 guide rollers being used on either side of the gate leaf, ensure that both wheels never touch the leaf simultaneously.
- Avoid using more than 1 guide roller on the same side of the gate leaf to prevent binding.
- As with the wheels the larger the guide the less rolling resistance generated.

Gate Travel:

Using a fisherman's pull scale, as shown below, pull the gate fully open and fully closed at approximately the same speed as the operator you intend to use (see technical specifications). For optimum performance, ensure that the maximum resistance does not exceed 30kgF starting and 24kgF running. The starting resistance should fall away within 300 to 500mm. Note the recommended track, wheel and guide types mentioned b) and c) above.

NB! Install physical stoppers at the ends of the gate travel to prevent the gate over-running the ends of the track as shown here. (National safety standard requirement)

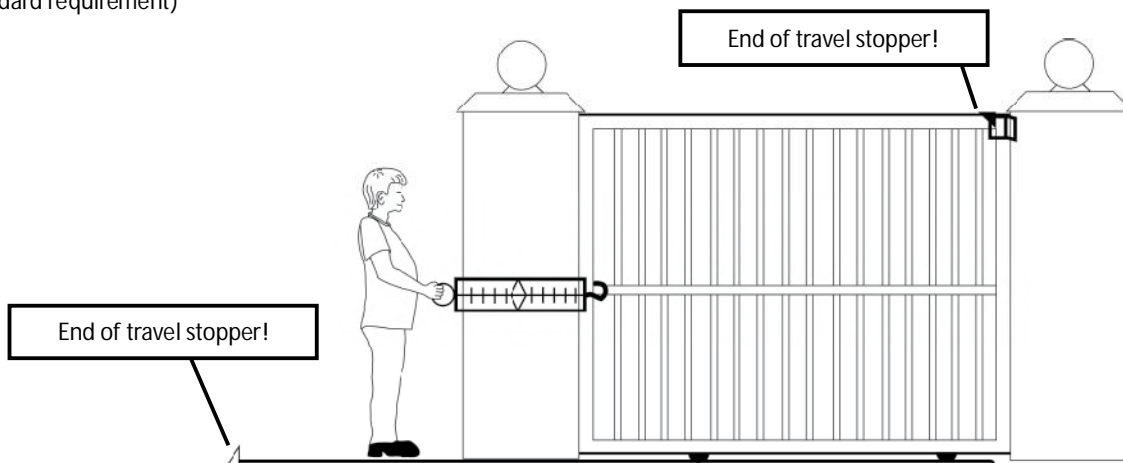

Duty Cycle.

The Formula used to determine duty cycle is:

$$\frac{\text{Run time}}{\text{Run time} + \text{rest time}} \times 100 = \text{Duty cycle}$$

Working example 1: (Low duty cycle)

Run time: 12 seconds.

Rest time: 36 seconds.

$$12 \div 48 \times 100 = 25$$

Thus the duty cycle in example 1 is said to be 25%

Working example 2: (High duty cycle)

Run time: 12 seconds.

Rest time: 1 second.

$$12 \div 13 \times 100 = 92.3$$

Thus the duty cycle in example 2 is said to be 92.3%

The above examples do not factor in resistance and gate mass. These two elements contribute greatly to the amount of heat generated in your gate automation system.

Below are the maximum allowed duty cycles based on the gate mass and rolling resistance for the ET motor models. These are calculated to conform to the standards set out in the SANS 60335-95-1:2011 safety code.

Duty cycle capabilities guideline of the ET Drive series motor models:

Model	Gate Mass	Starting resistance	Rolling resistance	Max Duty Cycle
Drive 300	≤ 300kg	≤ 30kgf	≤ 24 kgf	25%

Where to position the gate motor.

Liquid ingress:

The ET Drive series motor models all carry an ingress protection rating of IPX4. This means they are protected from splashing water. They are not water tight as there are sensitive electronic and electrical circuits that require uninhibited airflow to remain cool and dry.

When deciding on an installation position, be aware of water collection points around and near the desired mounting position of the motor unit. If the water does not flow away quickly enough, it can seep into the system and cause expensive and possibly hazardous damage. Always install the unit higher than the highest level that any water flowing past the motor unit can reach.

Physical protection:

Whenever possible, always install the gate motor on the opposite side of the gate's guide/emergency post, to the driveway itself. This way it is out of the path of the motor vehicles as they pass through the entrance/exit.

Cabling requirements.

- Before mounting the operator ensure your cables and conduiting are in place to prevent any inconvenience at a later stage.
- All household mains cabling and circuits need to be installed by a qualified electrician and signed off by a registered electrician.
- Allow for spare cabling in case of faulty cable & breakages (especially important when using low specification cable).
- As automation systems vibrate when in use, it is highly recommended that only multi-stranded, flexible cables be used.
- If installing an intercom, remember to allow for sufficient cable cores for all the users of the system as per manufacturers cabling requirements.
- The Drive 300 motor is designed to facilitate 1 x 20mm conduit going directly into its housing from below. If more cabling needs to be routed to the motor, we suggest that a weatherproof electrical box be installed as a distribution box. All of the circuits can then be extended to the distribution box and terminated there.

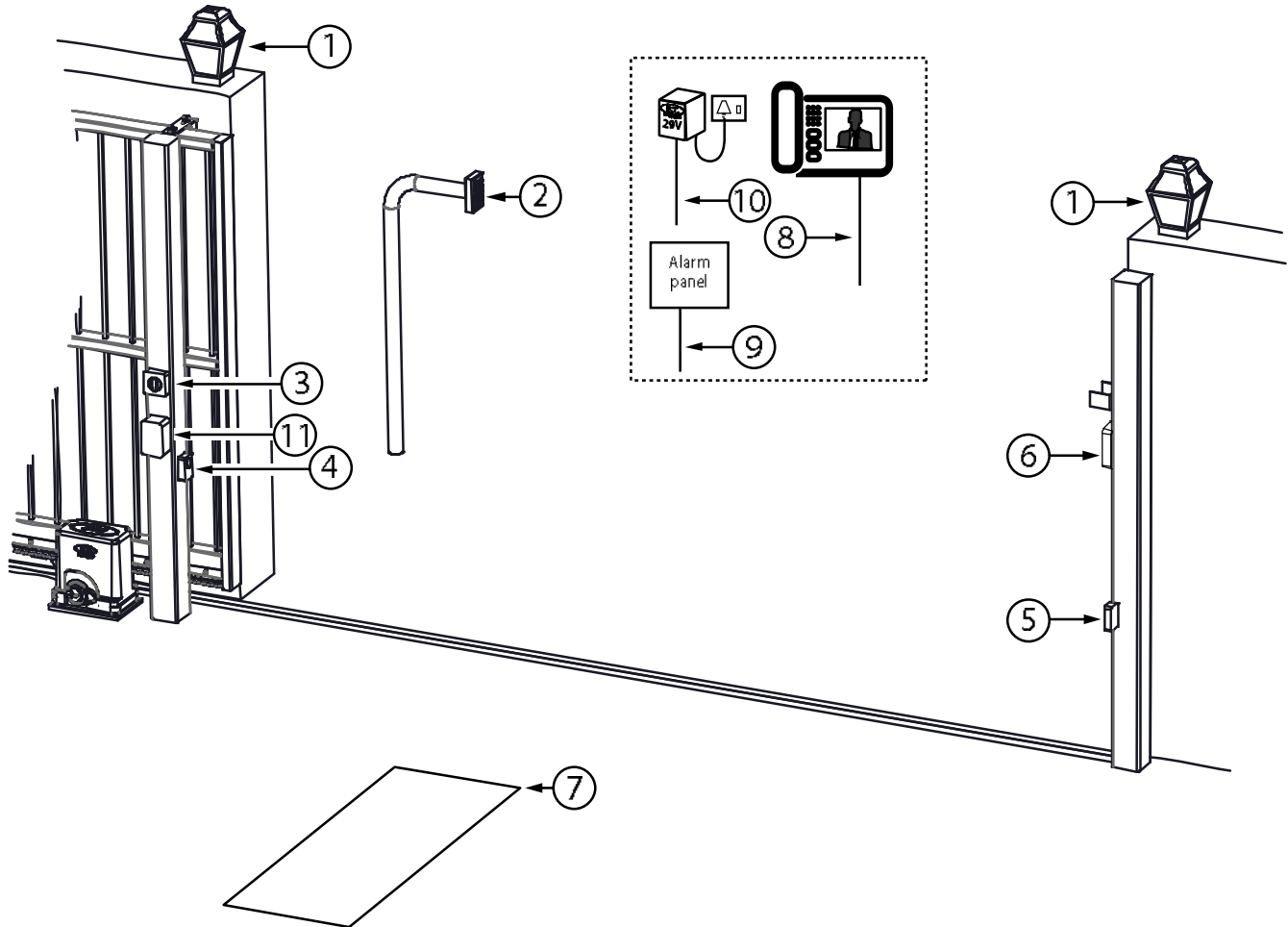

1.	Courtesy lights twin + earth 1.0mm back to motor housing and isolator switch.	7.	Free exit loop 1.5mm silicone insulated single core flexible stranded cable back to loop detector that is typically installed in the motor housing.
2.	Intercom gate station (check with intercom supplier for cable specifications)	8.	From intercom internal equipment (check with intercom supplier for specifications) + 5 cores 0,5mm stranded for status LED, BT and Pedestrian triggers.
3.	(220Vac) - twin + earth: 2,5mm stranded (An all pole negatively biased isolator must be installed within 1,5m of the motor unit, in circuit with the 220Vac supply)	9.	Alarm monitoring circuit. 2 cores 0,5mm stranded back to motor housing.
4.	Safety infra-red beam RX power & switch. 4 cores 0,5mm stranded back to motor housing.	10.	Optional plug in transformer for low traffic sites (29Vac) - twin + earth. Min 0,5mm stranded (1Amp)
5.	Safety infra-red beam TX power. 2 cores 0,5mm stranded back to motor housing.	11.	Lock power supply. Twin + earth 2,5mm stranded from isolator switch.
6.	Electric lock power. 2 cores 0,5mm stranded back to independent lock power supply via motor housing.		

Baseplate and fastener kit assembly.

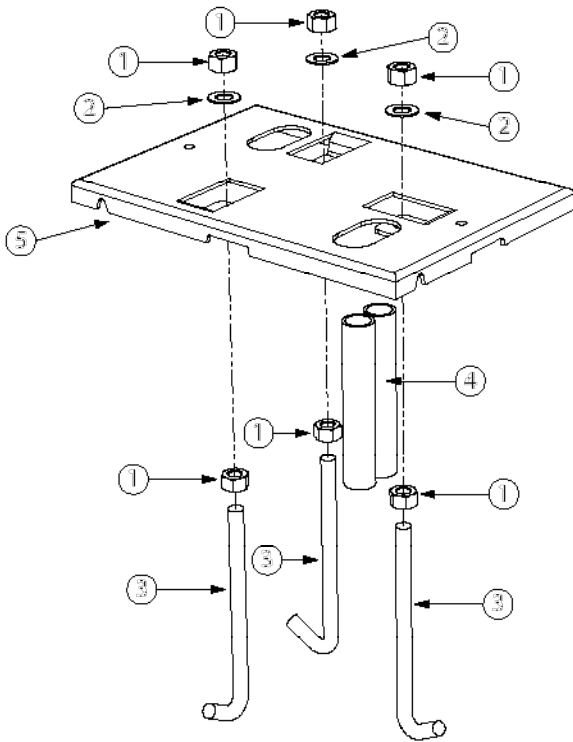
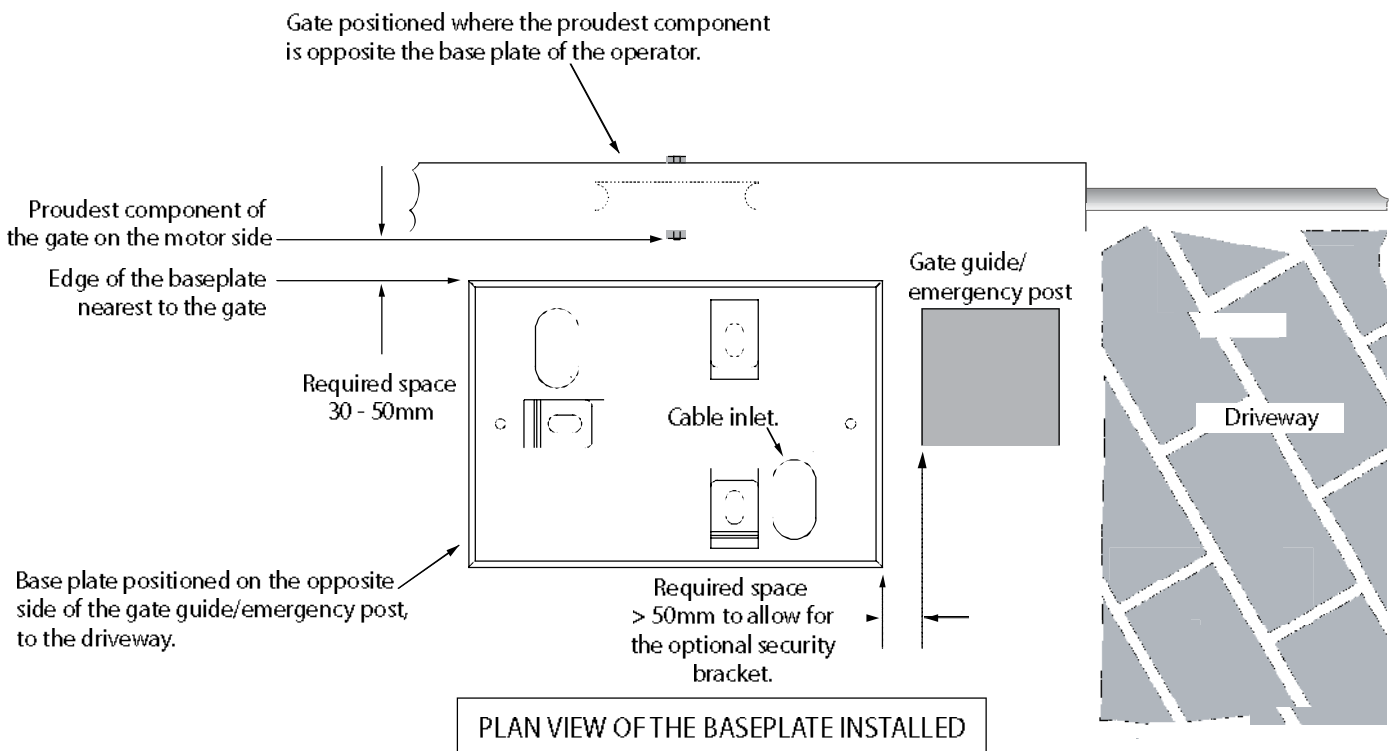

Diagram number	Description
1	M10 Machine nuts.
2	M10 Flat washers.
3	M10 J-Bolts for concrete casting method.
4	Cabling conduit piping.
5	Baseplate.

Installing the baseplate.

There are a number of different fastening techniques that can be used to fasten the baseplate in position. The standard kit is supplied with J-bolts so that the baseplate can be cast in concrete. While this method offers a nice solid base it takes more than 48hrs to install as the concrete must cure properly before continuing with the installation. Whichever mounting method you opt for, the position of the base plate will always remain the same. Below are the dimensions to use when positioning the baseplate. The baseplate should be installed above the highest point of flooding that may occur with the run off of water down the driveway.



Cabling conduits height:

Trim the conduits off where the ends are level with the top of the baseplate. If any part of the conduits protrude above the top of the baseplate, it will be difficult to adjust the position of the gearbox on top of the baseplate.

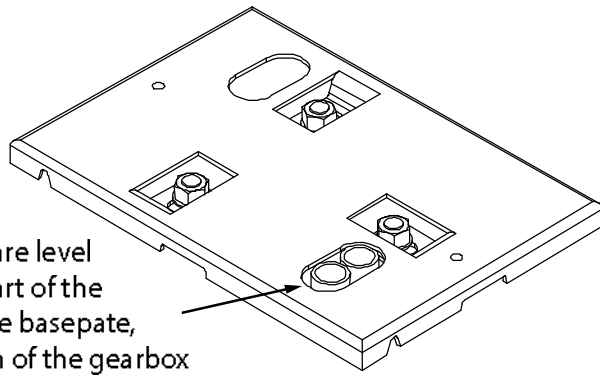

How to use the manual release.

Move gate open and closed by hand.

1. Unlock the manual release lever lock using the key supplied.
2. Swing the manual release lever upright to disengage the gearbox.

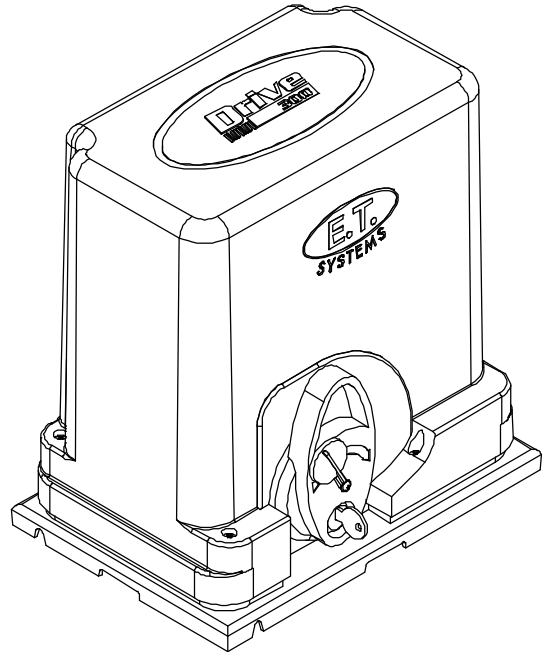
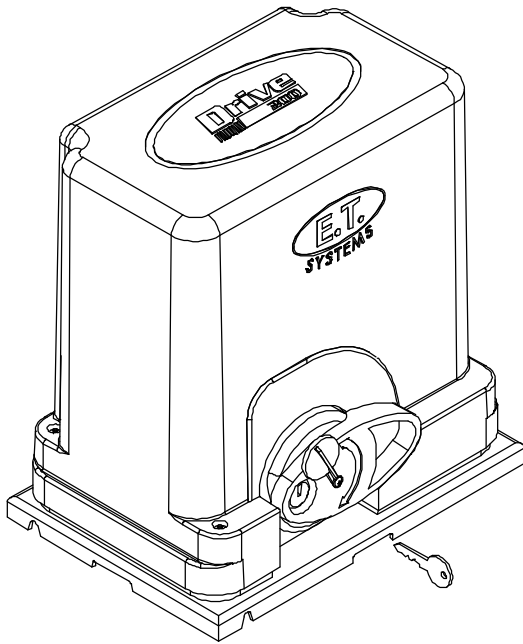

To re-engage the gearbox lower the manual release lever and lock it once again. Gently pull or push the gate by hand until the gears fall into place before triggering the unit to run.

Referencing the closed position

On the first trigger subsequent to the gearbox being engaged after a manual release, the gate will close at half speed. The system is looking for the closed position which is the origin point. This is known as referencing the closed position. If any of the trigger inputs are activated or the safety overload sensing is activated while the gate is busy "referencing" then the gate will simply stop. The next trigger will cause the unit to continue "referencing". While referencing the closed position the display will show $r \in f$. Referencing the closed position will also occur on the first trigger after exiting programming or powering up a previously programmed control card.

Mounting the operator onto the baseplate.

Removing the cover:

The cover is secured in place by means of four screws. One of which is secured beneath the manual override lever.

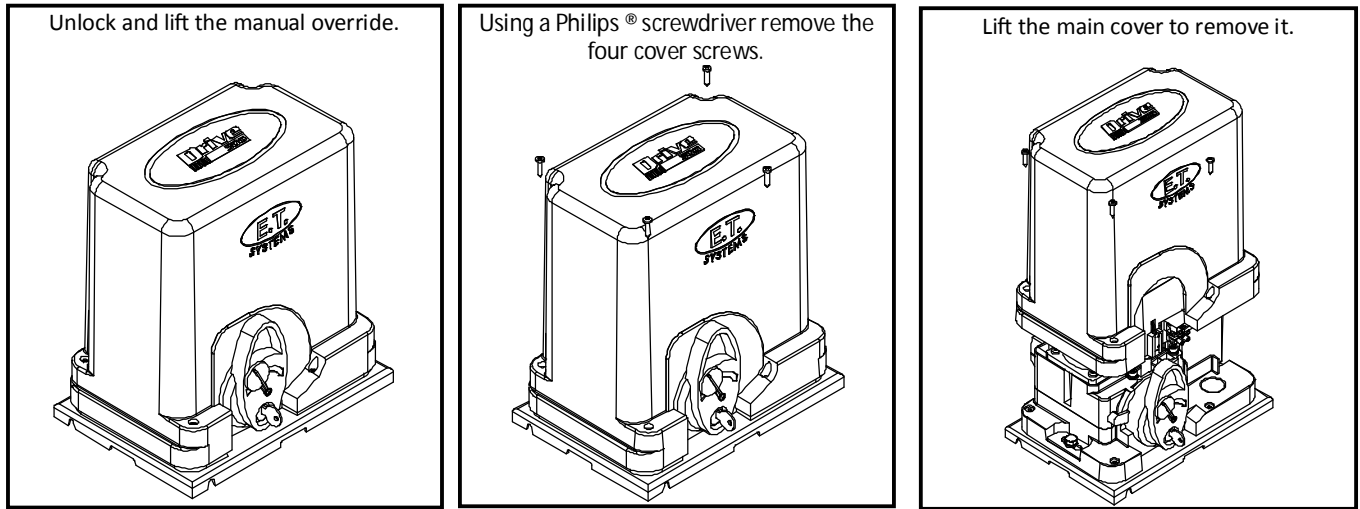

Mounting the gearbox: (You will need a 13mm socket or spanner)

The gearbox is fastened onto the baseplate by means of the 2 x 25mm x M8 machine bolts and custom mounting plates. The gearbox distance from the gate can be adjusted backwards and forwards by up to 30mm. Remember to ensure that there is enough space allowed between the fascia of the pinion and the proudest part of the gate that passes the pinion. This is to prevent any part of the gate snagging on the pinion as the gate runs. At this stage of the installation it is recommended that you place 2 x 2mm thick flat bars in between the baseplate and motor to facilitate the correct rack height later. See page 12 and 13 overleaf.

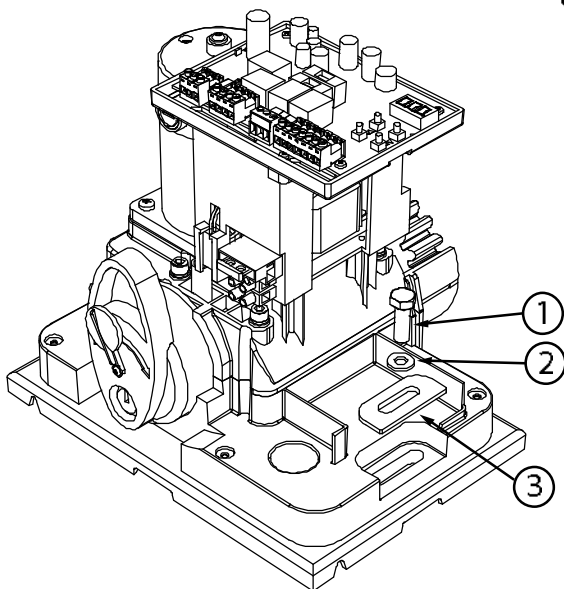
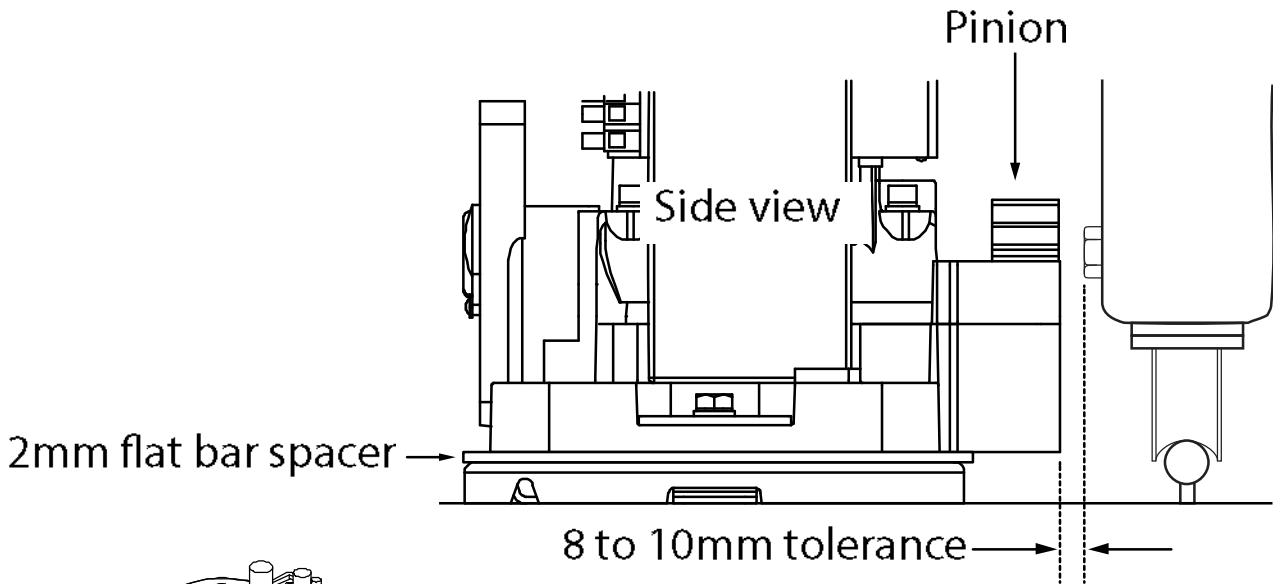

Diagram number	Description
1	M8 Machine bolt.
2	M8 Flat washer.
3	Mounting plate.

Installing the rack.

Rack to pinion spacing.

Correct.	Incorrect!	Incorrect!
<p>The driving surfaces of each tooth are 1 to 2mm apart. Allowing for slight variance in the height of the rack when the wheels shrink in colder conditions or where the gate flexes and the rack is no longer square to the pinion.</p>	<p>This will cause skipping of teeth at the slightest resistance to the gate travel, resulting in the motor control going out of synchronization to the gate position. The long term damage here will be stripped teeth.</p>	<p>This will cause unwanted rolling resistance especially in colder conditions. Where the wheel shrinkage will cause the gate to sit heavier on the pinion or when the rack is no longer square to the pinion due to gate flex. (False safety sensing activation)</p>
Correct	Too loose	Too tight

The following shows a simple method of installing a rack that ensures you achieve the correct fit between the rack and pinion.

- Clamp the end of the first length of rack's end to the closing edge of the gate.
- Rest the other end of the length on the pinion as shown here.
- Use a spirit level to ensure the rack remains true.

Rack resting on pinion

Spirit level

Rack clamped to end of gate

2mm flat bar spacers

- If satisfied with the rack level fasten the first "TEK" screw (supplied) in the middle of the slot nearest the closing edge of the gate.

- Move the gate towards the open position. Far enough that you can access the last mounting slot at the opposite end of the length of rack to the end already fastened. Fasten the next "TEK" screw here while the rack still rests atop the pinion.

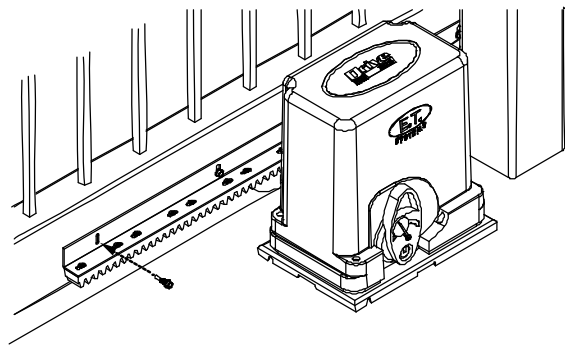

- To install additional lengths of rack, move gate closed until the next length of rack meets the first length and the opposite end once again rests on the pinion.
- To ensure the 2 lengths of rack marry correctly use an off cut of rack clamped upside down across the join of the 2 lengths.
- Continue to fasten the "TEK" screws as before

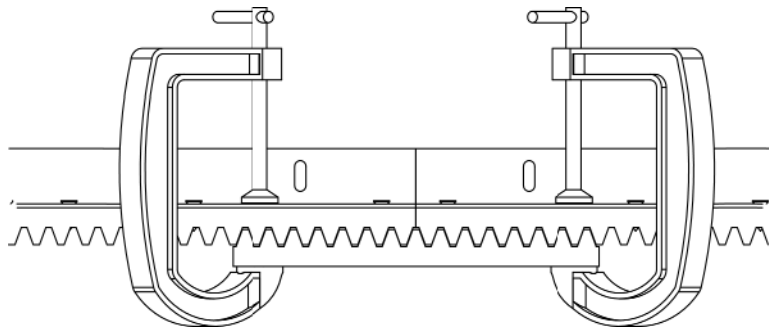

- When finished installing sufficient rack to allow for the full travel of the gate plus enough to allow for the limit actuator (as shown in the next section) lower the gearbox by removing the two 2mm spacer bars.

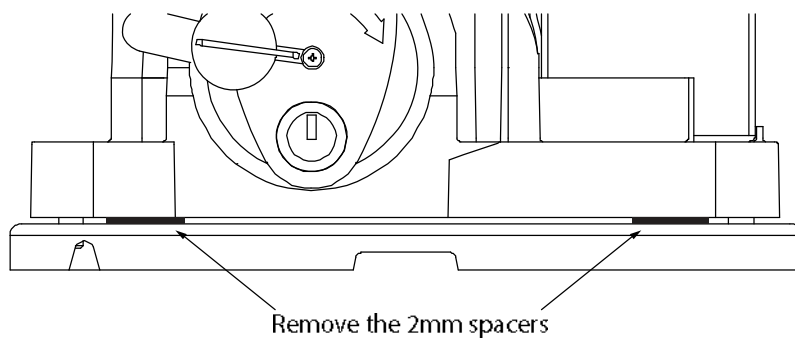

- Test the meshing of the rack and pinion. (See pictures of rack to pinion spacing on previous page).
- If satisfied fasten a "TEK" screw directly through both the rack angle and the gate so that you have 5 "TEK" screws per length of rack evenly spaced.

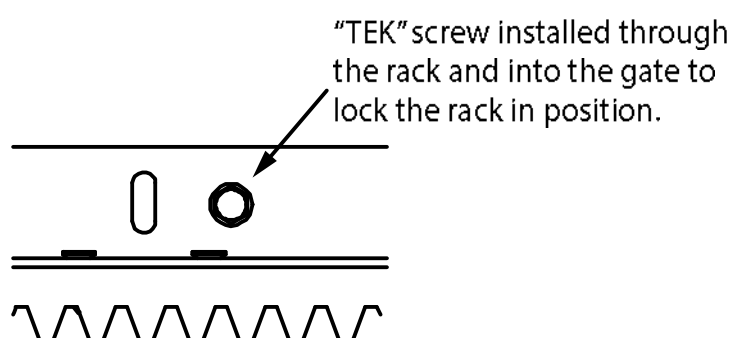

Electrical and electronic installation and setup.

As a gate motor vibrates when in use, it is strongly recommended that only multiple strand flexible cables be used.

Before closing the unit, always remember to double check that all connections are securely made, that there are no stray strands flaring out that can short circuit against other adjacent connections or bared wires and that no cables will be pulled loose when the cover is replaced on the unit.

Double check the battery connections as loose connections can cause arcing and corrosion of the battery terminals.

Terminating the AC voltages:

If you have chosen to install the standard kit which requires 220Vac at the gate motor then the 220Vac must be circuited through a weatherproof all pole isolator switch. This isolator switch must be installed within 1,5m of the unit, must not be installed within the workings of the system (the gate may not pass in front of it) and must be positioned so that it cannot be tampered with for the outside of the property. This circuit must be certified by way of a C.O.C. (certificate of compliance) by a registered electrician.

In the case of the plug-in transformer option being used, where the low voltage 29Vac is run to the gate, there is no need for the all pole isolator at the gate and the circuit does not need to be certified by a registered electrician*. The cable however must still be installed in its own dedicated conduit pipe and the basic principles of electrical safety standards should still be followed when selecting, working with and installing the cable for this circuit.

* Some municipalities may require certification of all domestic electrical circuits including those below 50V.

Terminating the 220Vac supply at the motor.

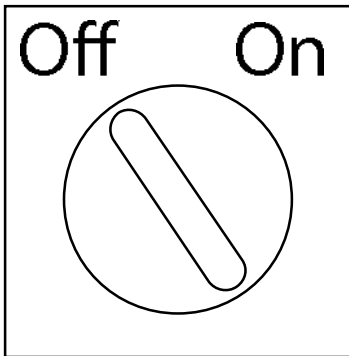

Ensure the 220Vac has been isolated.

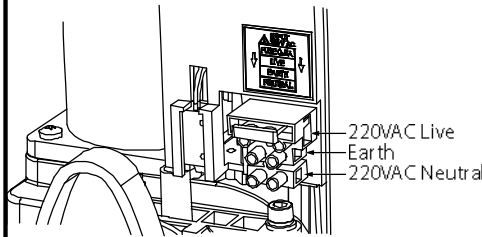

Terminate the 220Vac and earth as shown here.

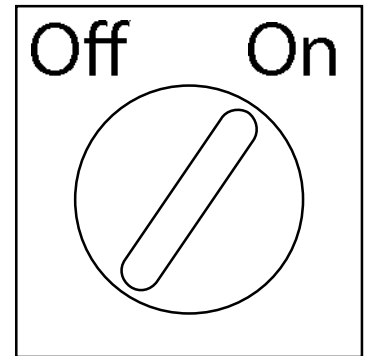

Switch the 220Vac back on.

Accessing the 220VAC 0.5A fuse in the case of a burnt out fuse.

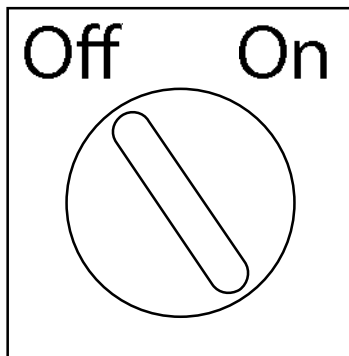

Ensure the 220Vac has been isolated.

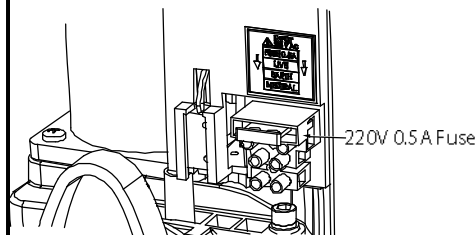

Replace the 0.5A 220V fast blow fuse here.

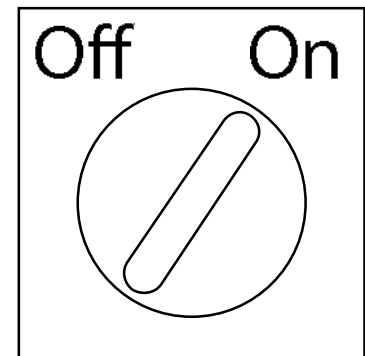

Switch the 220Vac back on.

Wiring and termination of the control card.

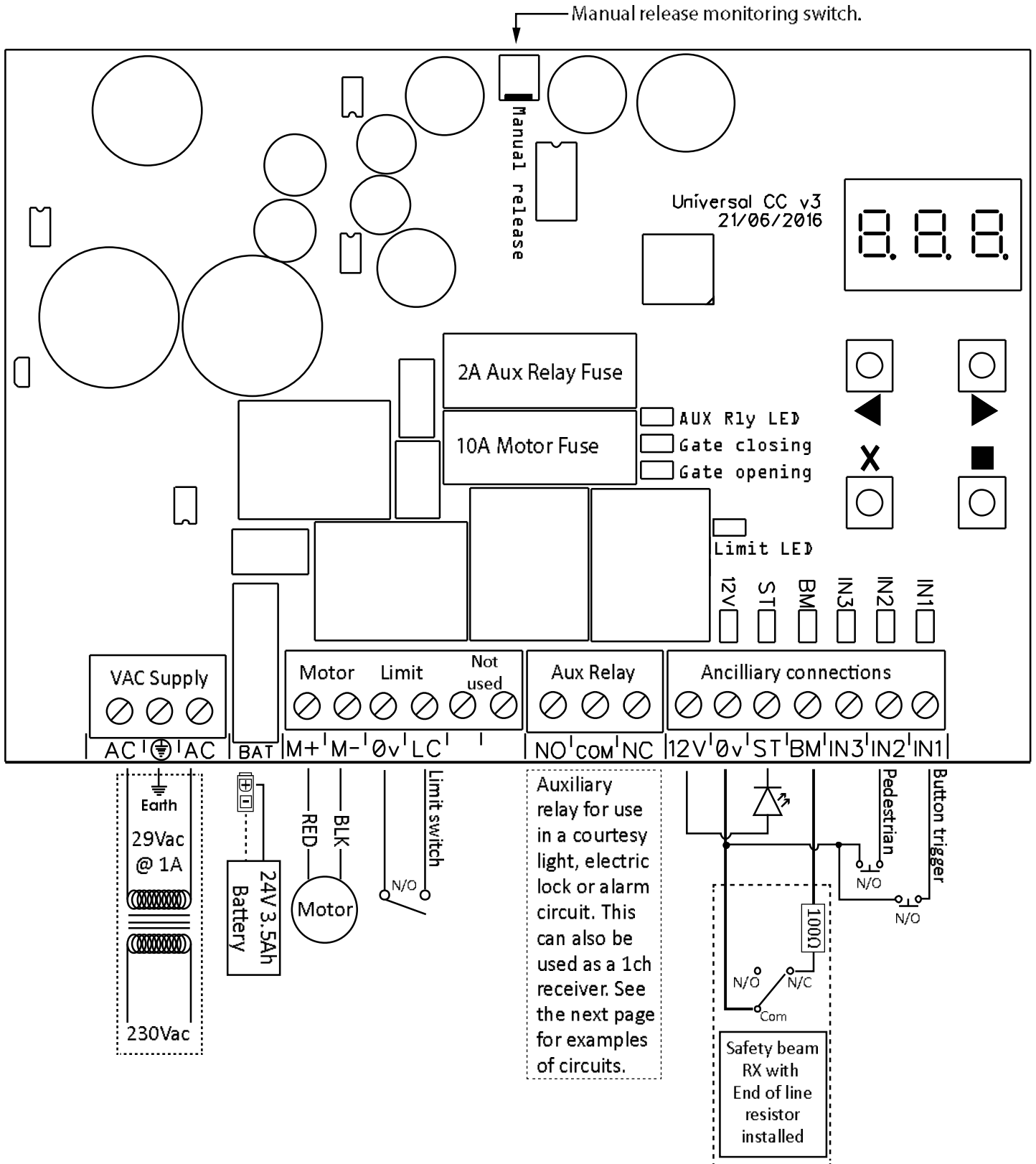

Label	Description	Label	Description
AC	29VAC input.	COM	Auxiliary relay common input.
BAT	Battery power input.	NC	Auxiliary relay normally closed output.
M+	Motor red output.	12V	Ancillaries 12VDC power output.
M-	Motor black output.	0V	0V Common output.
0V	0V Common output.	ST	Status LED output. (-)
LC	Closed limit input.	BM	Safety beam (detection device) input.
LO	Not used	IN1	Button trigger input. Full opening.
5V	Not used	IN2	Pedestrian trigger input. Partial opening.
NO	Auxiliary relay normally open output.	IN3	Not used

Wiring and termination of the control card - Auxiliary relay examples.

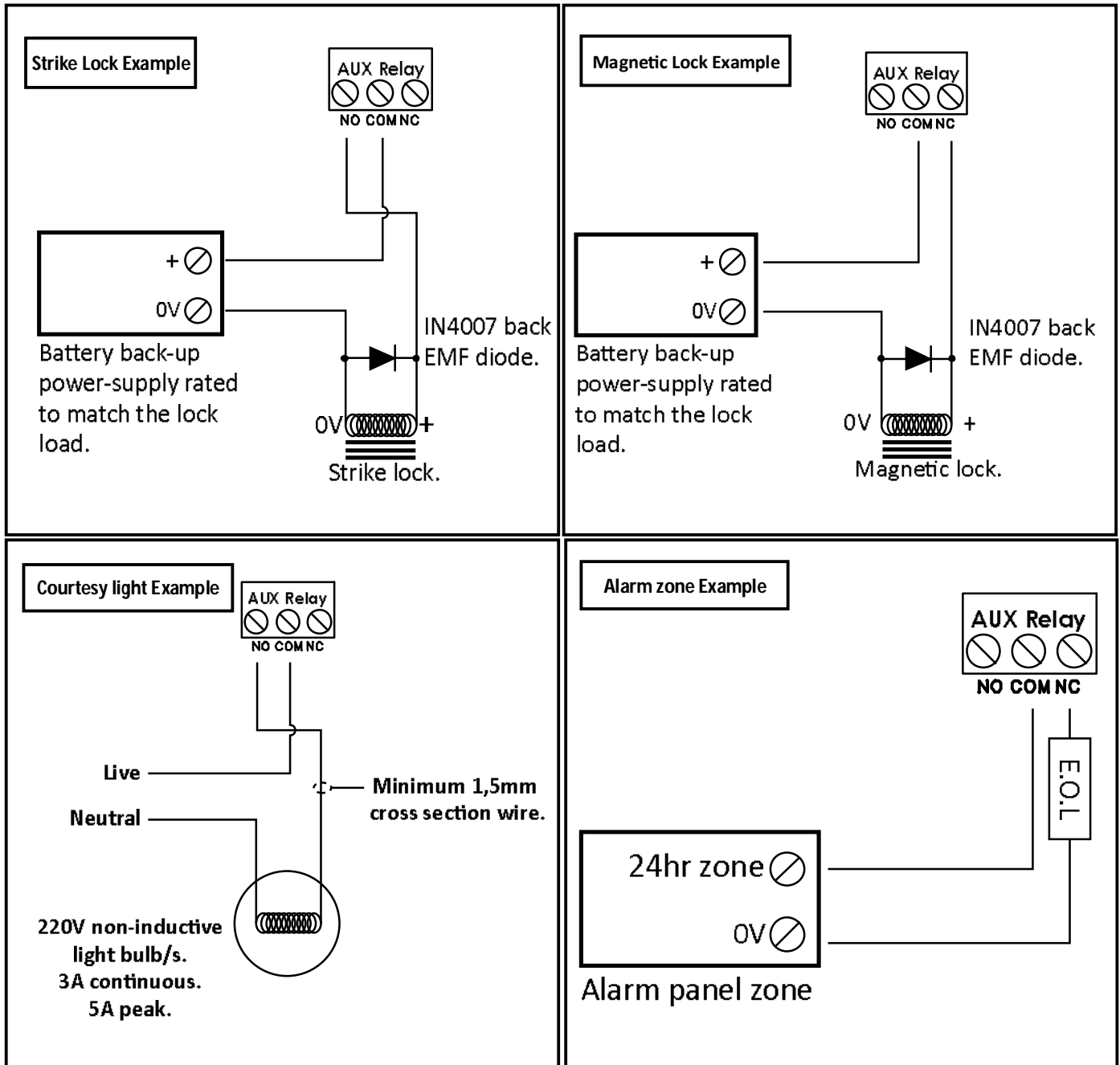

Installing the limit actuator.

This diagram depicts how to install the limit actuator.

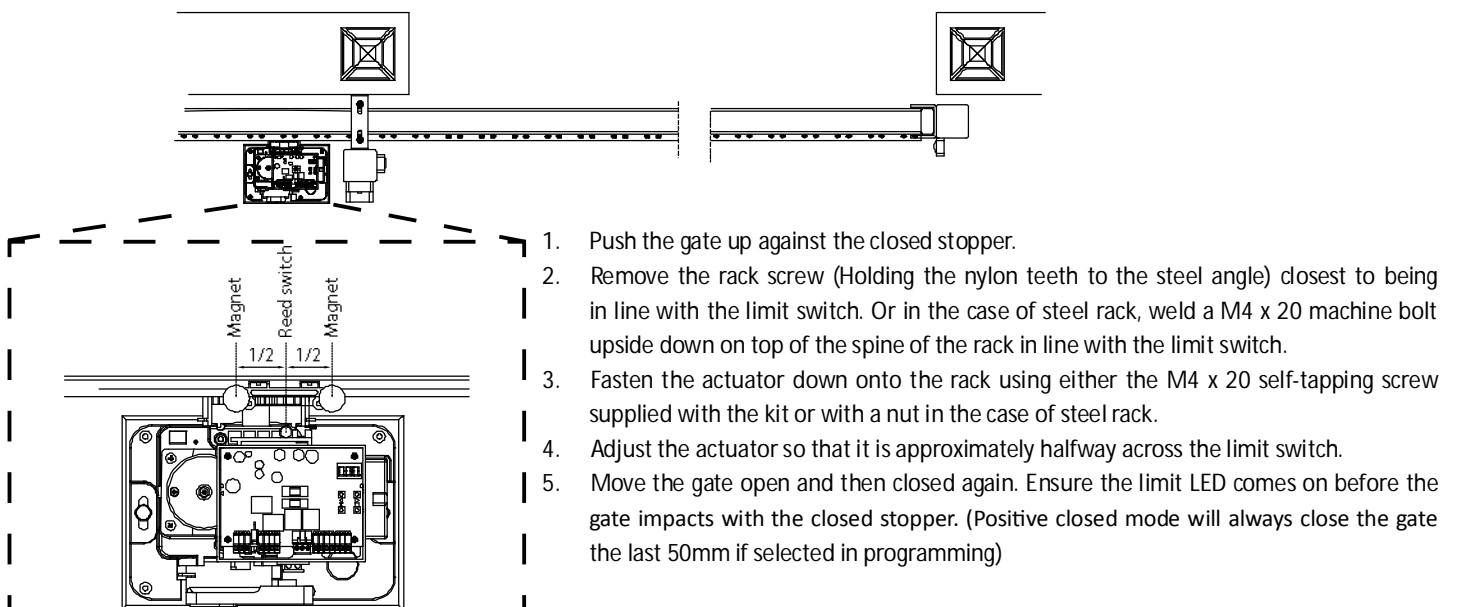

Before continuing with the commissioning.

If you are unfamiliar with the functionality of this product's modes, it is suggested that you familiarise yourself with the basic and advanced operating features detailed from page 32 of this instruction manual.

Using the control card display and dashboard.



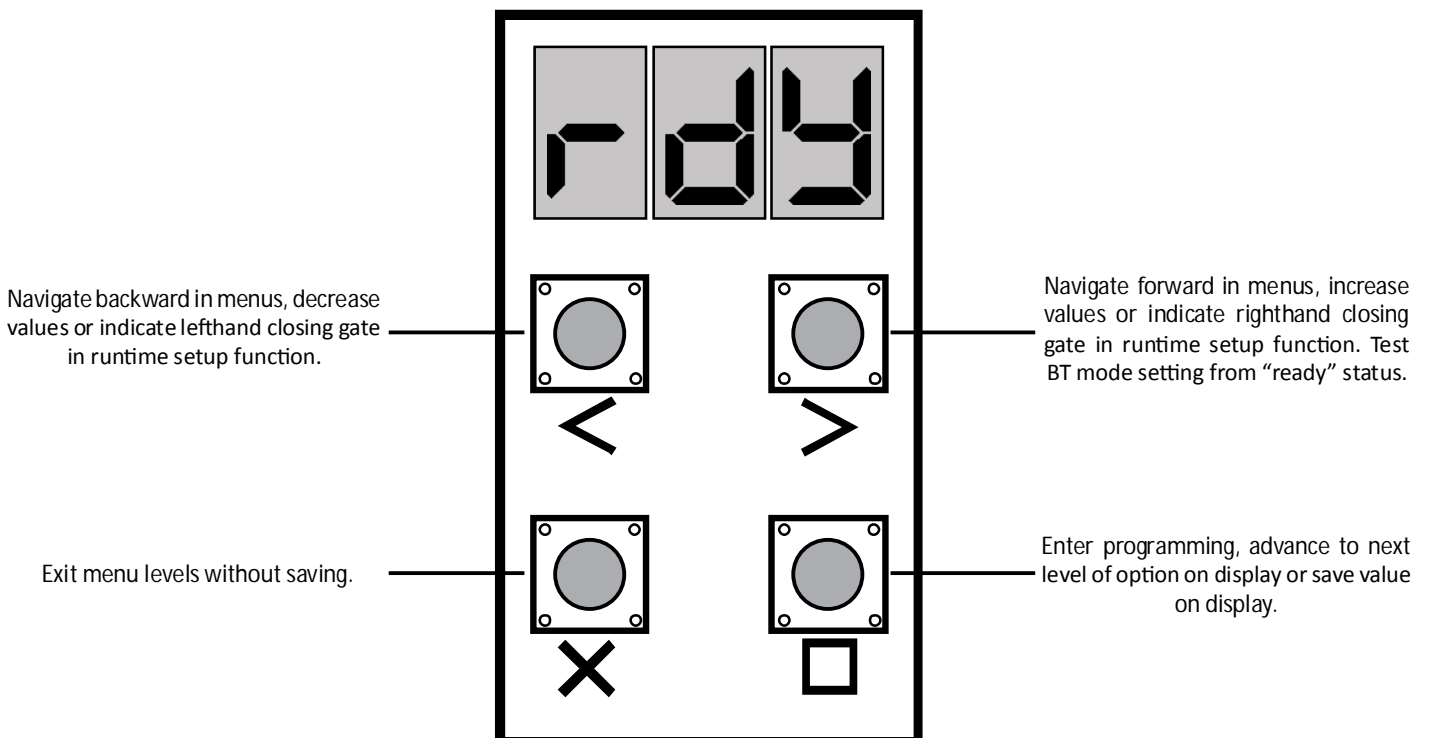





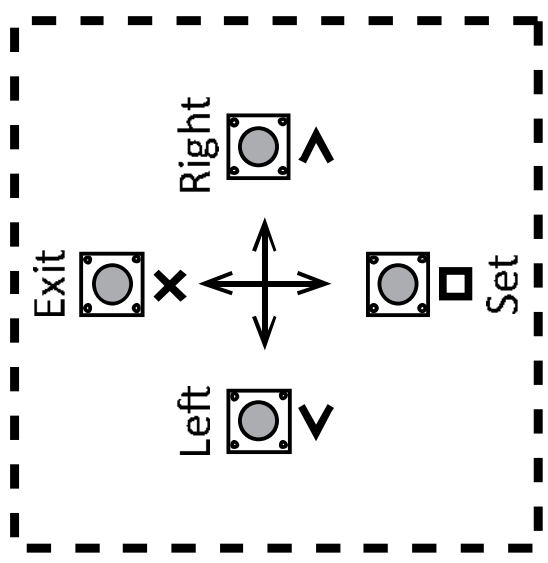
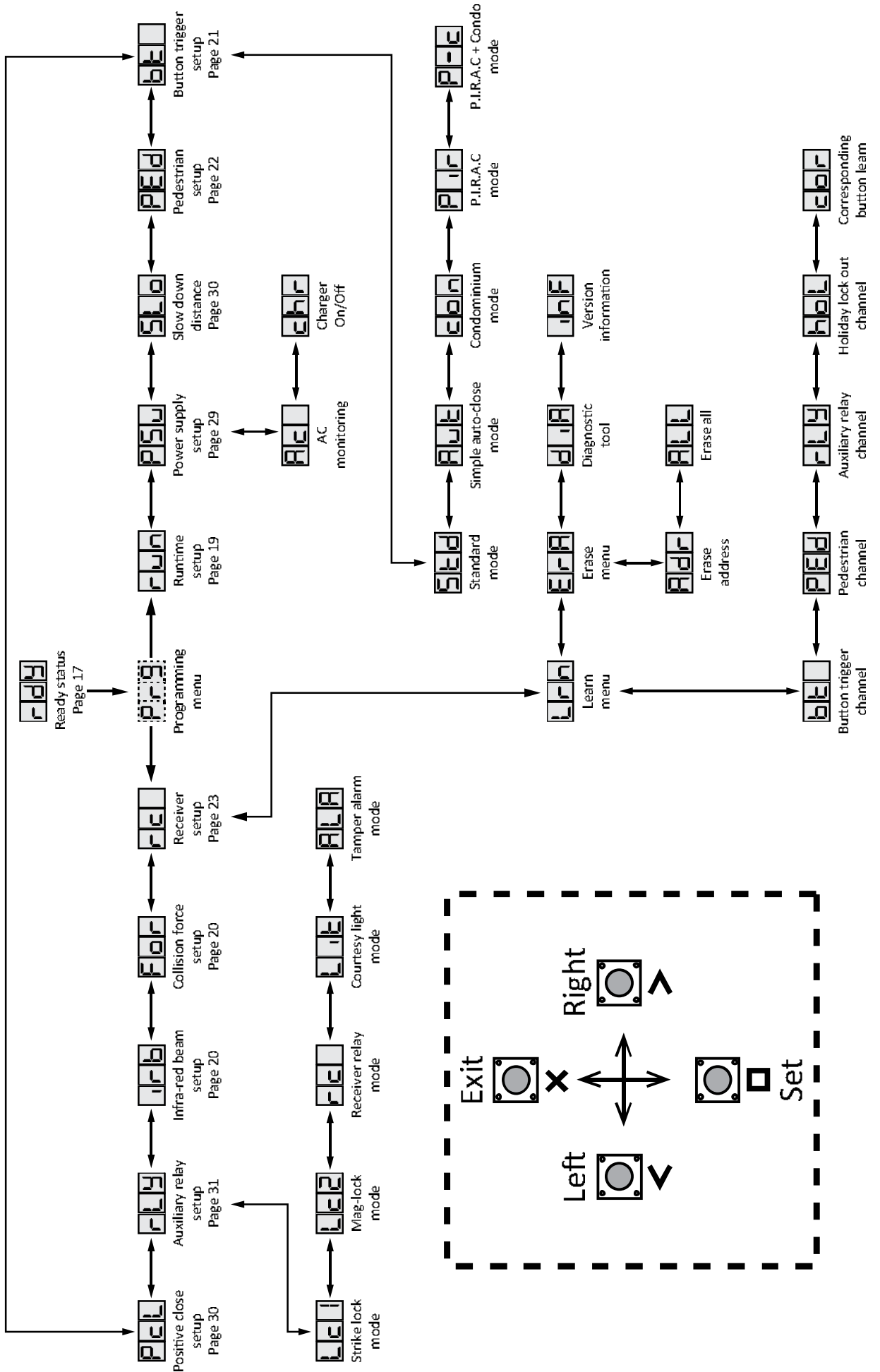

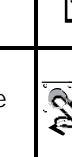
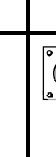



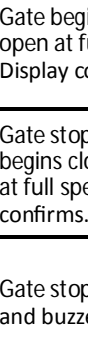

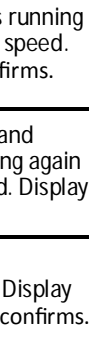

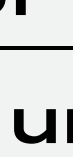

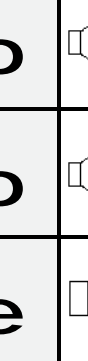



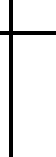

The Drive 300 is equipped with an LED display and interactive keys for simplified programming and diagnostics. All setup of the various features requires that the control card dashboard be used. Below are the functions of each key on the dashboard.













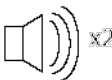







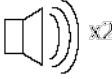

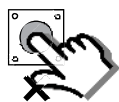

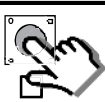
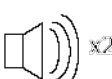

Control card programming and setup.



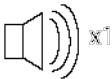



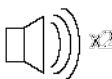

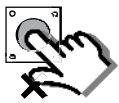







Programming menu quick reference guide:







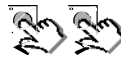





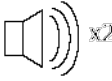
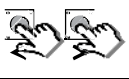

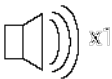
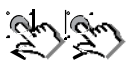

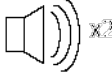

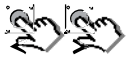

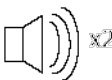
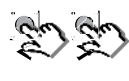
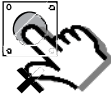



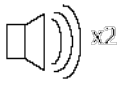

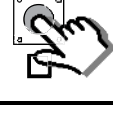
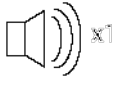
Setting up the gate runtime. (Mandatory)				run	
From Ready status		r dy		<p>Before continuing with the runtime setup ensure the limit actuator has been installed correctly as per page 16 in this manual. Begin with the gate midway in its travel.</p> <p>NB. To speed up the gate while running during this procedure, press and hold either the < or > buttons.</p>	
Action	Response				
	Description	Display	Buzzer	Gate/s	
To enter the program menu. Press and hold the  button until buzzer beeps.		Display and buzzer confirms.	pr 9		
Scroll < or > to select the runtime setup option.		Display scrolls through options.	run		
Ensure gate is engaged midway and then press  button.		Display prompts you to confirm gate closing direction.	cl di r		
Confirm gate closing direction by pressing and releasing either the < or > button.		Gate closes slowly. Display confirms.	Lft r 9t		
When the closed position is reached and the closed limit is triggered. LED on.		Gate stops and starts opening.	l rn		
Press and release the  button to stop the gate at the required open position.		Gate stops opening. Display asks you to fine adjust the open position if required.	adj		
Fine adjust the open position using the < or > buttons, if necessary.		Gate moves with each button press in either direction.	adj		
When satisfied with the open position, press and release the  button to save that position.		Gate closes slowly. Display and buzzer confirms.	l rn		
When the closed position is reached and the closed limit is triggered. LED on.		Gate stops. Display and buzzer warn the profiling is about to begin.	pro		
Once warning tone has stopped.		Gate begins running open at full speed. Display confirms.	pro		
When the previously programmed open position is reached.		Gate stops and begins closing again at full speed. Display confirms.	pro		
When the closed position is reached and the closed limit is triggered. LED on.		Gate stops. Display and buzzer confirms.	dne		
Scroll left or right to next program option.		OR	EXIT back to ready status		r dy

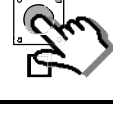
for		Selecting a safety level.			
From Ready status		rdy	This adjusts the force level, over and above the nominal gate resistance, needed to trigger the safety overload routines. Level 1 being the most sensitive and 8 being the least sensitive. The factory default is level 3.		
Action		Response			
		Description	Display	Buzzer	Gate
To enter the program menu. Press and hold the  button until buzzer beeps.		Display and buzzer confirms.	pr 9	 x2	
Scroll < or > to select the collision force setup option.		Display scrolls through options.	for		
With "For" on the display, press and release  .		Display shows current option status.	003	 x1	
Scroll < or > to the required setting.		Display changes respectively.	006		
With required setting displayed, press and release  .		Display briefly shows the new setting is saved.	006	 x2	
After display confirms new setting.	006	Display returns to programming menu options list.	for		
Scroll left or right to next program option.		OR	EXIT back to Ready status		rdy

irb		Safety infra-red beams setup.			
From Ready status		rdy	Use this option to enable the safety beam circuit. The safety beams circuit must be configured as per page 15 with the end of line resistor installed.		
Action		Response			
		Description	Display	Buzzer	Gate
To enter the program menu. Press and hold the  button until buzzer beeps.		Display and buzzer confirms.	pr 9	 x2	
Scroll < or > to select the beam setup option.		Display scrolls through options.	irb		
With "irb" on the display, press and release  .		Display shows current option status.	off	 x1	
Scroll < or > to toggle between "on" or "off".		Display changes respectively.	on		
With required setting displayed, press and release  .		Display briefly shows the new setting is saved.	on	 x2	
After display confirms new setting.	Beam Setup Enabled Saved	Display returns to programming menu options list.	irb		
Scroll left or right to next program option.		OR	EXIT back to standby status		pr 9

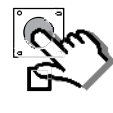
Selecting a BT operating mode and adjusting the BT auto-close time.				bt	
From Ready status		rdy	<p>The factory default is standard 3 step mode. The factory default auto-close time is 15 seconds. The timer range is 1 – 254 seconds. PLEASE NOTE!! A set of safety infra-red beams must be installed using the technique indicated in this manual before selecting any of the auto-close modes. If “irb” mode has not been configured then the auto-close modes are blanked out of programming and not available. The safety beam function on this control card conforms to the CE safety standards.</p>		
Action		Response			
		Description	Display	Buzzer	Gate
To enter the program menu. Press and hold the  button until buzzer beeps.		Display and buzzer confirms.	pr 9	 x2	
Scroll < or > to select the bt setup option.		Display scrolls through options.	bt		
With “bt” on the display, press and release  .		Display shows current option status.	5td	 x1	
Scroll < or > to the required BT mode option.		Display changes respectively.	5td		
			aut		
			con		
			pi r		
			p- c		
With required setting displayed, press and release  .		<p>If Standard mode was selected, the display and buzzer will confirm the setting is saved. Display then reverts to programming options list.</p> <p>If Auto-close, CONDO, P.I.R.A.C. or P.I.R.A.C.+ CONDO were selected, then the display prompts you to select the required auto-close time.</p>	bt	 x2	
			015		
Scroll < or > to the required setting.		Display changes respectively.	010		
With required setting displayed, press and release  .		Display briefly shows the new setting is saved.	010	 x2	
After display confirms new setting.	010	Display returns to programming menu options list.	bt		
Scroll left or right to next program option.		OR	EXIT back to standby status		rdy

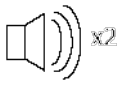
ped		Setting up the pedestrian open distance and pedestrian auto-close time.			
From Ready status		r dy		<p>NB! The runtime setup must be completed first before the pedestrian setup can be attempted.</p> <p>The factory default pedestrian opening is 1000 mm. The factory default auto-close time is 2 seconds. The timer range is 1 – 254 seconds.</p> <p>PLEASE NOTE!! If no safety beams are installed then the pedestrian mode reverts to 3 step mode where the gate will not auto-close. A set of safety infra-red beams must be installed using the technique indicated in this manual to allow for auto-closing in pedestrian mode. The safety beam function on this control card conforms to the CE safety standards.</p>	
Action		Response			
		Description	Display	Buzzer	Gate
To enter the program menu. Press and hold the  button until buzzer beeps.		Display and buzzer confirms.	pr 9	 x2	
Scroll < or > to select the pedestrian setting option.		Display scrolls through options.	ped		
With "Ped" on the display, press and release  .		Display shows current pedestrian opening distance. in 100mm increments.	010	 x1	
Scroll < or > to the required setting.		Display changes respectively.	00.7		
With required setting displayed, press and release  .		If irb mode has not been configured then the display briefly shows the new setting is saved and reverts back to the programming options list.	ped	 x2	
		If irb mode has been configured then the display briefly shows the new setting is saved and then displays the current pedestrian mode auto-close time.	002	 x2	
Scroll < or > to the required setting if necessary.		Display changes in seconds with each button press.	001		
With required setting displayed, press and release  .		Display briefly shows the new setting is saved and buzzer confirms.	001	 x2	
After display confirms new setting.	001	Display returns to programming menu options list.	ped		
Scroll left or right to next program option.		OR	EXIT back to standby status		r dy

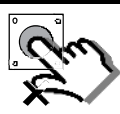
Receiver programming and setup. Setting up a new user.				l r n	
From Ready status		r d y		The gate can be in any position when performing this routine. Please note that if an ET BLU MIX © transmitter is being used and not all of the buttons have been set to the same format, then the receiver will allocate 2 user addresses for the various buttons. 1 for the buttons set to ET BLU MIX© and 1 for the buttons set to ET BLUE.	
Action		Response			
		Description	Display	Buzzer	Gate
To enter the program menu. Press and hold the  button until buzzer beeps.		Display and buzzer confirms.	pr 9		
Scroll < or > to select the receiver setup option.		Display scrolls through options.	rc		
With "rc" on the display, press and release  .		Display shows current option status.	l r n		
With "Lrn" on the display, press and release  .		Display prompts you to select a function.	bt		
Scroll < or > to the required receiver function/channel option. NB! Corresponding 4 function learn option is explained in the next instruction table on the next page.		Display changes respectively.	bt ped r l y hol cor		
Press and hold required button on the remote transmitter.					
While still transmitting with the remote button, press and release  .		After the  button has been released, the user address for that transmitter displays and the buzzer beeps confirms.	001		
Release the button on the remote transmitter.					
Repeat the last 4 steps here for additional users or functions, or exit back one level in the receiver setup menu for other receiver setup options.					
Scroll left or right to next program option.		OR	EXIT back to standby status		r d y

cor	Receiver programming and setup. Setting up a new user. (Corresponding 4 function learn option)
------------	---

From Ready status	rdy	The gate can be in any position when performing this routine.
-------------------	------------	---

Action		Response			
		Description	Display	Buzzer	Gate
To enter the program menu. Press and hold the button until buzzer beeps.		Display and buzzer confirms.	pr 9	x2	
Scroll < or > to select the receiver setup option.		Display scrolls through options.	rc		
With "rc" on the display, press and release .		Display shows current option status.	l rn	x1	
With "Lrn" on the display, press and release .		Display prompts you to select a function.	bt		
Scroll < or > to the corresponding learn option.			cor		
Press and hold any button on the remote transmitter. All four buttons must be set to the same format for this to work in the same way as this example.					
While still transmitting with the remote button, press and release .		After the button has been released, the user address for that transmitter displays and the buzzer beeps once.	002	x2	
Release the button on the remote transmitter.					







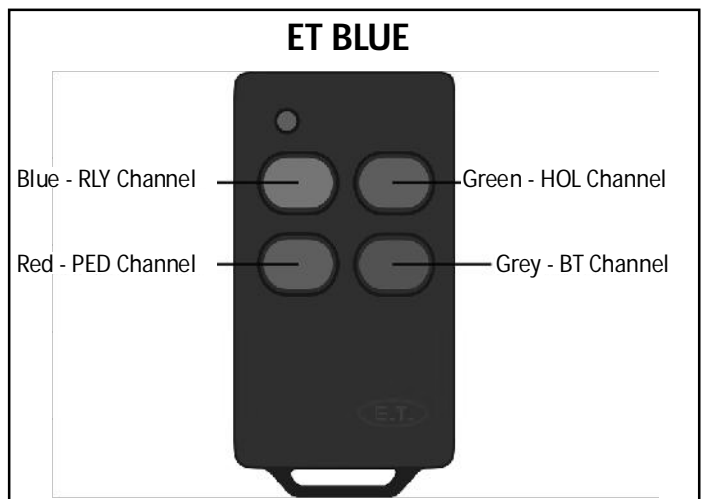
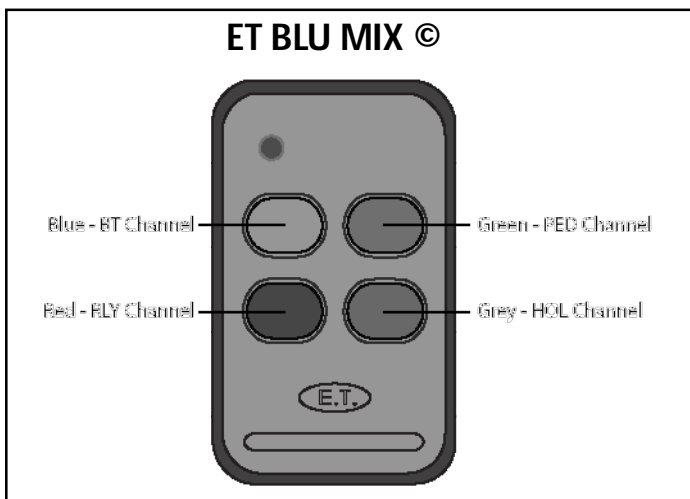





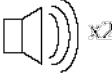



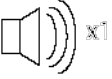

Each button on that remote transmitter has been allocated to the channels on the receiver. Please see below for the automatic button to receiver channel allocations.



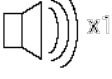



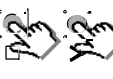
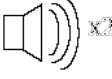













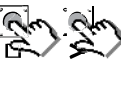
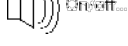

Repeat the last 4 steps here for additional users or exit back one level in the receiver setup menu for other receiver setup options.

Scroll left or right to next program option.		OR	EXIT back to standby status		rdy
--	--	----	-----------------------------	--	------------















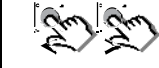

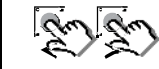

All buttons should be set to either ET BLUE format or ET BLU MIX © format for this to work as shown here.















Receiver programming and setup. Erasing a single user from the memory.				adr	
From Ready status		rdy		The gate can be in any position when performing this routine.	
Action		Response			
		Description	Display	Buzzer	Gate
To enter the program menu. Press and hold the  button until buzzer beeps.		Display and buzzer confirms.	pr 9		
Scroll < or > to select the receiver setup option.		Display scrolls through options.	rc		
With "rc" on the display, press and release  .		Display shows current option status.	Lrn		
Scroll < or > to select the Erase remotes option.		Display scrolls through options.	era		
With "ErA" on the display, press and release  .		Display shows first erase option.	adr		
With "Adr" on the display, press and release  .		First user address displays.	001		
Scroll < or > to the user address that you would like to erase.		Display scrolls through user addresses.	003		
With the correct user address displayed, press and hold  .		Display begins flashing the user address selected.	003		
While still holding  press the > button.		Display confirms the user address erase is done.	dne		
After the display confirms the erasing of the address is done release the buttons.	dne	Display reverts back to the user address erased.	001		
Repeat the last 4 steps here to erase additional users or exit back one level in the receiver setup menu for other receiver setup options.					
Scroll left or right to next program option.		OR	EXIT back to standby status		rdy

all		Receiver programming and setup. Master erasing all users from the memory.			
From Standby status		rdy	The gate can be in any position when performing this routine.		
Action		Response			
		Description	Display	Buzzer	Gate
To enter the program menu. Press and hold the  button until buzzer beeps.		Display and buzzer confirms.	pr 9		
Scroll < or > to select the receiver setup option.		Display scrolls through options.	rc		
With "rc" on the display, press and release  .		Display changes to "Lrn" and buzzer beeps once	l rn		
Scroll < or > to select the Erase remotes option.		Display scrolls through options.	era		
With "ErA" on the display, press and release  .		Display changes to "Adr" and buzzer beeps once.	adr		
Scroll < or > to select the Erase ALL memory option.		Display scrolls through options.	all		
With "ALL" on the display, press and hold  .		"ALL" remains displayed	all		
While still holding  press the > button.		Buzzer begins beeping intermittently and "ALL" begins flashing. NB! Releasing either button at this point will "Can" cancel the master erase.	all		
Keep holding the buttons.		Display changes to "---" and buzzer silences. The master erase has begun.	---		
Release the buttons.		Buzzer beeps and "dnE" displays to indicate master erase is done.	dne		
Press and release X to return to the main receiver programming menu.		Display changes to "ALL" and buzzer beeps.	all		
Scroll left or right to next program option.		OR	EXIT back to standby status		rdy

**Receiver programming and setup.
Using the diagnostics feature.**

di a

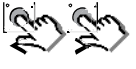
From Ready status		rdy	The gates can be in any position when performing this routine.		
Action		Response			
		Description	Display	Buzzer	Gate
To enter the program menu. Press and hold  until buzzer beeps.		Display and buzzer confirms.	pr 9	 x2	Not applicable.
Use the < or > buttons and scroll until "rc" displays			rc		Not applicable.
With "rc" on the display, press and release  .		Display changes to "Lrn" and buzzer beeps once	l rn	 x1	Not applicable.
Use the < or > buttons to select "diA"		Display changes with each button press.	di a		Not applicable.
With "diA" on the display, press and release  .		Display changes to the signal strength indicator and buzzer beeps once	i	 x1	Not applicable.
In the case of any transmitter on the same frequency as the receiver, being active in the area, the signal strength guide will display how strong the incoming interfering signal is.		Weak signal	i		Not applicable.
		Low signal.	ii		Not applicable.
		Low/medium signal	iii		Not applicable.
		Medium signal	iiii		Not applicable.
		Medium/strong signal	iiiii		Not applicable.
		Strong signal	iiiiii		Not applicable.
Press and release a remote transmitter button already learnt into the receiver memory.		Buzzer beeps once and user address display momentarily.	008	 x1	Not applicable.
		Followed by the channel that button is learnt into.	bt		Not applicable.
		Followed by the signal strength of the transmission.	iiiiii		Not applicable.
When done testing remotes, press and release X to return to the main receiver programming menu.		Display changes to "diA" and buzzer beeps once	di a	 x1	Not applicable.
Scroll < or > to next program option.		OR	EXIT back to Ready status		rdy

i nf		Receiver programming and setup.			
		Viewing the receiver version and information. "inF"			
From Ready status		rdy	The gates can be in any position when performing this routine.		
Action		Response			
		Description	Display	Buzzer	Gate
To enter the program menu. Press and hold  until buzzer beeps.		Display changes to "Prg" and buzzer beeps.	pr 9	 x2	Not applicable.
Use the < or > buttons and scroll until "rc" displays		Display changes with each button press.	rc		Not applicable.
With "rc" on the display, press and release  .		Display changes to "Lrn" and buzzer beeps once	l rn	 x1	Not applicable.
Use the < or > buttons to select "inF"		Display changes with each button press.	i nf		Not applicable.
With "inF" on the display, press and release  .		Buzzer beeps once and the display scrolls through the receiver information. Note the position of the decimal point each time the display changes.		 x1	Not applicable.
		Users already in memory.	010		Not applicable.
			of		Not applicable.
		User memory capacity.	032		Not applicable.
		Software version.	002		Not applicable.
		Hardware version.	003		Not applicable.
		Device identification.	002.		Not applicable.
When done, press and release X to return to the main receiver programming menu.		Display changes to "inF" and buzzer beeps once	i nf	 x1	Not applicable.
Scroll < or > to next program option.		OR	EXIT back to Ready status		rdy













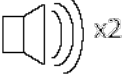

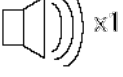

Switching the AC Monitoring and/or built-in charger on or off.





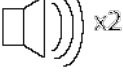
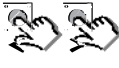

p5u





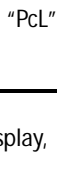

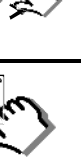
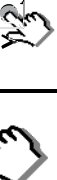
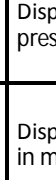

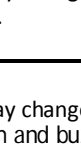
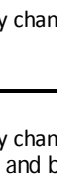
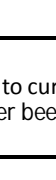
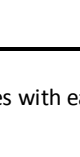
From Ready status

rdy

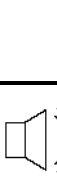
The gate can be in any position when performing this routine.
The factory default is:
AC Monitoring - On
Charger - On

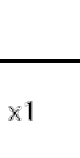
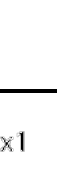
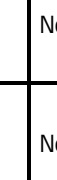

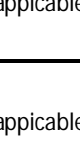
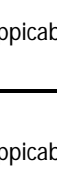
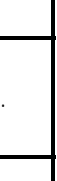









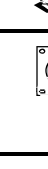

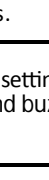

Action		Response			
		Description	Display	Buzzer	Gate
To enter the program menu. Press and hold the  button until buzzer beeps.		Display changes to "Prg" and buzzer beeps.	pr 9		Not applicable.
Scroll < or > to select "PSu" setup option.		Display changes with each button press.	p5u		Not applicable.
With "PSu" on the display, press and release  .		Display changes to "Ac" and buzzer beeps.	Ac		Not applicable.
Scroll < or > to the required setting.		Charger.	chr		Not applicable.
		AC Monitoring.	ac		
With required selection displayed, press and release  .		The current setting for that option is displayed and buzzer beeps once	on		Not applicable.
Scroll < or > to the required setting.		Display changes with each button press.	off		Not applicable.
With required selection displayed, press and release  .		Display reverts to "PSu" buzzer beeps.	p5u		Not applicable.
Scroll left or right to next program option.		OR	EXIT back to standby status		rdy

5l o		Adjusting the length of the slow speed at the ends of travel.			
From Ready status		rdy		The gate can be in any position when performing this routine. The factory default is: 200mm	
Action		Response			
		Description	Display	Buzzer	Gate
To enter the program menu. Press and hold the  button until buzzer beeps.		Display changes to "Prg" and buzzer beeps.	pr 9	 x2	Not applicable.
Scroll < or > to select "Slo" setup option.		Display changes with each button press.	5l o		Not applicable.
With "Slo" on the display, press and release  .		Display changes to current setting in mm and buzzer beeps.	200	 x1	Not applicable.
Scroll < or > to the required setting.		Display changes with each button press.	100		Not applicable.
With required selection displayed, press and release  .		Display reverts to "Slo" and buzzer beeps.	5l o	 x1	Not applicable.
Scroll left or right to next program option.		OR	EXIT back to standby status		rdy

pcl		Switching positive close mode on or off.			
From Ready status		rdy		The gate can be in any position when performing this routine. The factory default is: Off	
Action		Response			
		Description	Display	Buzzer	Gate
To enter the program menu. Press and hold the  button until buzzer beeps.		Display changes to "Prg" and buzzer beeps.	pr 9	 x2	Not applicable.
Scroll < or > to select "Pcl" setup option.		Display changes with each button press.	Pcl		Not applicable.
With "Pcl" on the display, press and release  .		Display changes to current setting in mm and buzzer beeps.	of f	 x1	Not applicable.
Scroll < or > to the required setting.		Display changes with each button press.	on		Not applicable.
With required selection displayed, press and release  .		Display reverts to "Pcl" and buzzer beeps.	pcl	 x2	Not applicable.
Scroll left or right to next program option.		OR	EXIT back to standby status		rdy

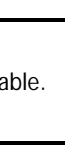
Selecting the Auxiliary relay's mode of operation.

rly

From Ready status		rdy	The gates can be in any position when performing this routine. The factory default is Lc1 Strike-lock mode.		
Action		Response			
		Description	Display	Buzzer	Gate
To enter the program menu. Press and hold the  button until buzzer beeps.		Display changes to "Prg" and buzzer beeps.	pr 9	 x2	Not applicable.
Scroll < or > to select "rLy" setup option.		Display changes with each button press.	rly		Not applicable.
With "rLy" on the display, press and release  .		The current setting is displayed and buzzer beeps once	l c 1	 x1	Not applicable.
Scroll < or > to the required setting.		Strike-lock mode	l c 1		Not applicable.
		Mag-lock mode	Lc2		
		Receiver relay mode	rc		
		Courtesy light mode	l i t		
		Alarm mode	al a		
With required selection displayed, press and release  .		If Lc1, Lc2, Lit or ALA modes were selected, the buzzer beeps twice and "rly" is displayed.	rly	 x2	Not applicable.
		If rc was selected, the buzzer beeps once and the current relay on time setting is displayed.	001	 x1	Not applicable.
Use the < or > buttons to change the relay pulse length or to select latch mode		Latch mode.	l a t		Not applicable.
		Minimum pulse length in seconds.	001		
		Maximum pulse length in seconds.	255		
With required selection displayed, press and release  .		Display reverts to "Prg" and buzzer beeps twice.	pr 9	 x2	Not applicable.
Scroll left or right to next program option.		OR	EXIT back to standby status		rdy

In the case of the gate colliding with an obstruction, such as a person passing through the entrance way, the collision sensing will automatically detect the collision and the system will run a safety overload routine. If at anytime the gate collides four times consecutively with an obstruction without reaching either the closed or open position successfully, the unit will initiate multiple collision lock-out. This safety feature is indicated by a continuous beep tone while holding any trigger button in and the display shows "coL". To clear this condition, activate the manual release and clear the obstruction. Re-engage the manual release as per page 10 of this manual and continue to use the system as per normal.

Safety overload routine while gate is opening.

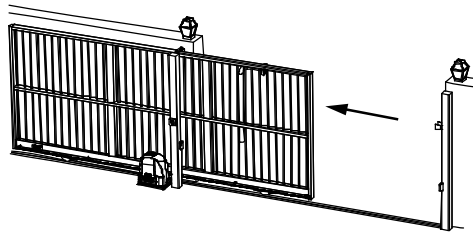

	Action		Response	
Gate collides with a pedestrian for example.		Gate stops opening.		
Once gate has stopped.		Gate reverses momentarily to release pressure.	No buzzer tones.	
After reversing momentarily.		Gate stops and waits for next trigger to close.	No buzzer tones.	

Safety overload routine while gate is closing.

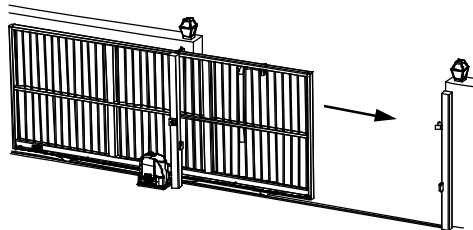

	Action		Response	
Gate collides with a pedestrian for example.		Gate stops closing.		
Once gate has stopped.		Gate reverses back to the full open position.	No buzzer tone.	
After reversing to the full open position.		Gate remains in the full open position until the next trigger to close.	No buzzer tone.	

If the safety beam input has been switched on, the control card will constantly monitor to ensure a set of safety beams is installed.

NB! A set of safety beams must be installed and the safety beam input must be configured .

Below is an example of how the gates will behave whenever the safety beam input is activated.

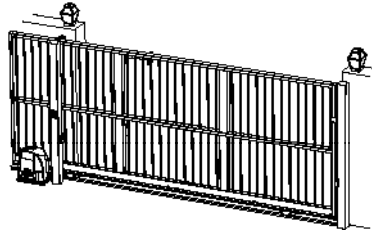

Action		Response		
Momentary BT trigger.		Gate begins opening.	No buzzer tones.	
Safety beam input triggered while gate is opening.		Gate continues opening	No buzzer tones.	
At full open position. Safety beam input still triggered.		Gate stops and waits for next trigger to close.	No buzzer tones.	
Momentary BT trigger.		Trigger is ignored and gate remains open.	No buzzer tones.	
Safety beam input cleared.		Gate remains in the full open position until the next trigger to close.	No buzzer tone.	
Momentary BT trigger.		Gate begins closing.	No buzzer tone.	
Safety beam input while the gate is closing.		Gate stops and reverses open.	No buzzer tone.	
At the full open position.		Gate stops and waits for next trigger to close.	No buzzer tone.	
Momentary BT trigger.		Gate begins closing.	No buzzer tone.	

The BT functions are the primary full gate opening functions for motor vehicle access. There are two ways of activating the “BT” functions on this control card. Either via the hardwired BT input or the BT receiver channel.

In Standard mode the gates respond to each BT trigger. In Standard mode you have access to the following advanced features: - Holiday lock-out and Party mode.

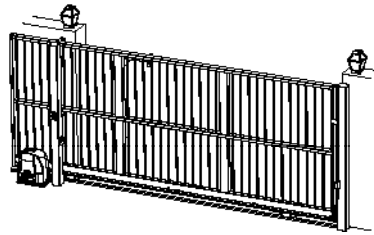

Action		Response		
Momentary BT trigger.		Gate begins opening.	No buzzer tones.	
At full open position.		Gate stops.	No buzzer tones.	
Momentary BT trigger.		Gate begins closing.	No buzzer tones.	
Momentary BT trigger.		Gate stops.	No buzzer tones.	
Momentary BT trigger.		Gate begins opening.	No buzzer tones.	
Momentary BT trigger.		Gate stops.	No buzzer tones.	
Momentary BT trigger.		Gate begins closing.	No buzzer tones.	
At full closed position.		Gate stops.	No buzzer tones.	

The BT functions are the primary full gate opening functions for motor vehicle access.
There are two ways of activating the "BT" functions on this control card. Either via the hardwired BT input or the BT receiver channel.

Simple auto-close mode functions exactly the same as standard mode except that the gates will close automatically after the programmed BT auto-close timer has timed out.

In this mode you have access to the following advanced features: - Holiday lock-out and Party mode.

NB! For any auto-close feature to work, a pair of safety infra-red beams must be installed and functioning correctly.

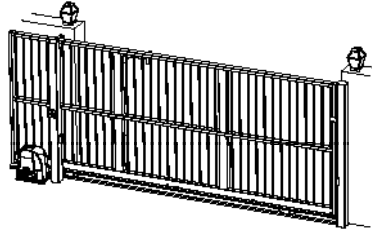

Action		Response		
Momentary BT trigger.		Gate begins opening.	No buzzer tones.	
At full open position.		Gate stops.	No buzzer tones.	
Momentary BT trigger or auto-close timer timeout. Safety beam input not triggered.		Gate begins closing.	No buzzer tones.	
Momentary BT trigger.		Gate stops and immediately starts opening again.	No buzzer tones.	
Momentary BT trigger.		Gate stops.	No buzzer tones.	
Momentary BT trigger or auto-close timer timeout. Safety beam input not triggered.		Gate begins closing.	No buzzer tones.	
At full closed position.		Gate stops.	No buzzer tones.	

Basic operating features	“BT” Button triggers. Condominium auto-close mode.	User manual reference - Page 11
--------------------------	---	------------------------------------

The BT functions are the primary full gate opening functions for motor vehicle access.
There are two ways of activating the “BT” functions on this control card. Either via the hardwired BT input or the BT receiver channel.

In Condominium auto-close mode, all BT triggers are treated as open, keep opening, keep open or re-open triggers. The gates will only close once the BT auto-close timer has timed out.

In Condominium auto-close mode the following advanced features are not available: - Holiday lock-out and Party mode.

NB! For any auto-close feature to work, a pair of safety infra-red beams must be installed and functioning correctly.

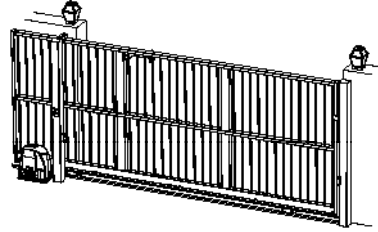

Action		Response		
Momentary BT trigger.		Gate begins opening.	No buzzer tones.	
Momentary BT trigger while gate is opening.		The trigger is ignored and the gate continues opening.	No buzzer tone.	
At full open position.		Gate stops and auto-close timer starts counting down.	No buzzer tones.	
Momentary BT trigger.		Gate remains open and auto-close timer resets.	No buzzer tones.	
Auto-close timer timeout. Safety beam input not triggered.		Gate begins closing.	No buzzer tones.	
Momentary BT trigger.		Gate stops and immediately starts opening again.	No buzzer tones.	
At full open position.		Gate stops and auto-close timer starts counting down.	No buzzer tones.	
Auto-close timer timeout. Safety beam input not triggered.		Gate begins closing.	No buzzer tones.	
At full closed position.		Gate stops.	No buzzer tones.	

User manual reference - Page 12	“BT” Button triggers. P.I.R.A.C. auto-close mode.	Basic operating features
------------------------------------	--	-----------------------------

The BT functions are the primary full gate opening functions for motor vehicle access.
There are two ways of activating the “BT” functions on this control card. Either via the hardwired BT input or the BT receiver channel.

In P.I.R.A.C. auto-close mode, all BT triggers are treated as per simple auto-close. The difference in this mode is how the system responds to the safety beam triggers while the gate is opening. Below is an example of P.I.R.A.C. auto-close mode when the safety beam circuit is triggered while the gate is in operation.

In this mode the following advanced features are available: - Holiday lock-out and Party mode.

NB! For any auto-close feature to work, a pair of safety infra-red beams must be installed and functioning correctly.

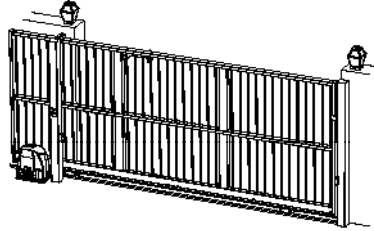

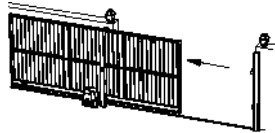
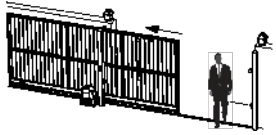
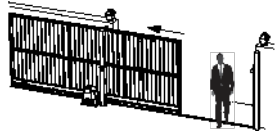
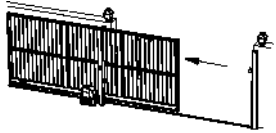
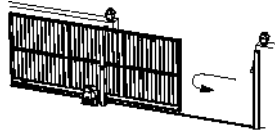
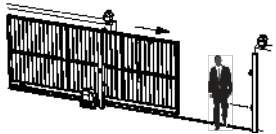
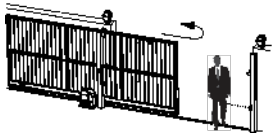
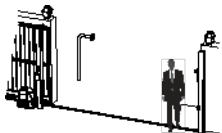
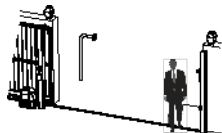
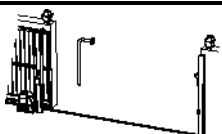
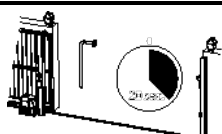
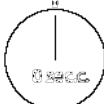
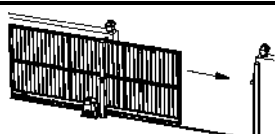
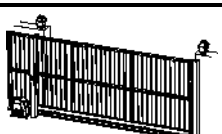
Action		Response		
Momentary BT trigger.		Gate begins opening.	No buzzer tones.	
Safety beam circuit triggered while gate is opening.		The gate continues opening.	No buzzer tone.	
Safety beam circuit cleared while gate is opening.		Gate stops and immediately starts closing again.	No buzzer tones.	
Safety beam circuit triggered while gate is closing.		Gate stops and immediately starts opening again.	No buzzer tones.	
Gate reaches open position while safety beam circuit is still triggered.		Gate remains open waiting for safety beam circuit to be cleared.	No buzzer tones.	
Safety beam circuit cleared while gate is in the open position.		Auto-close timer starts counting down.	No buzzer tones.	
Auto-close timer times out. Safety beam circuit not triggered.		Gate begins closing.	No buzzer tones.	
At full closed position.		Gate stops.	No buzzer tones.	





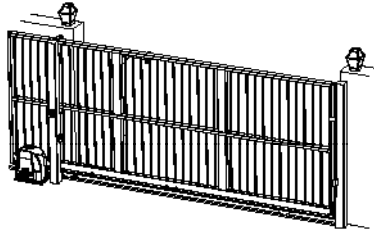

Basic operating features	“PED” Pedestrian trigger. (With no safety beams installed)	User manual reference - Page 13
--------------------------	---	------------------------------------

The PED trigger is a higher security option and is used when access to or from the property is limited to exclude motor vehicles. In the case of no safety beams being installed then the pedestrian auto-close functionality is disallowed for safety.

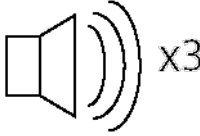
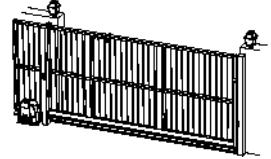
If the BT trigger is activated at any time during the pedestrian routine, the gate will open to the full open position and the pedestrian transaction is cancelled. The system then reverts to the BT trigger mode configured.

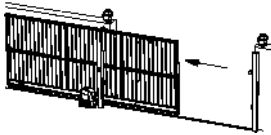
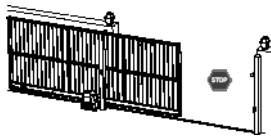
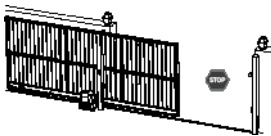
There are two ways of activating the “PED” functions on this control card. Either via the hardwired PED input or the PED receiver channel.

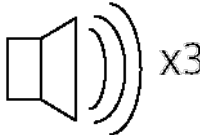
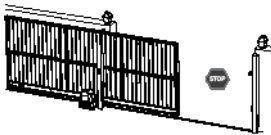

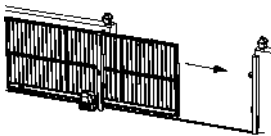
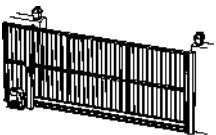
	Action	Response		
Momentary PED trigger.		Buzzer beeps pre-run warning.		
After buzzer silences.		Gate begins opening.	No buzzer tones.	
At previously programmed pedestrian opening distance.		Gate stops and waits for a pedestrian trigger to close.	No buzzer tones.	
Momentary PED trigger.		Buzzer beeps pre-run warning.		
After buzzer silences.		Gate begins closing.	No buzzer tones.	
At full closed position.		Gate stops.	No buzzer tones.	

The PED trigger is a higher security option and is used when access to or from the property is limited to exclude motor vehicles. If the safety beams are triggered while the gate is closing in pedestrian mode, the gate will only return to the preprogrammed pedestrian open position.

If the BT trigger is activated at any time during the pedestrian routine, the gate will open to the full open position and the pedestrian transaction is cancelled. The system then reverts to the BT trigger mode configured.

There are two ways of activating the “PED” functions on this control card. Either via the hardwired PED input or the PED receiver channel.

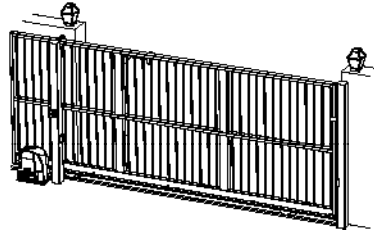

	Action	Response		
Momentary PED trigger.		Buzzer beeps pre-run warning.		
After buzzer silences.		Gate begins opening.	No buzzer tones.	
At previously programmed pedestrian opening distance.		Gate stops and the pedestrian auto-close timer starts counting down.	No buzzer tones.	
Momentary PED trigger or safety beam circuit trigger.		Pedestrian auto-close timer resets.	No buzzer tones.	
Pedestrian auto-close timer times out.		Buzzer beeps pre-run warning.		
After buzzer silences.		Gate begins closing.	No buzzer tones.	
At full closed position.		Gate stops.	No buzzer tones.	

With Strike lock mode selected, the auxiliary relay will pulse momentarily, half a second before the gate opens.

Whenever a lock is installed with the system, a separate battery backed up power supply matching the lock load must be installed. Failure to do this can damage the charger and battery of the control unit.

Below is an example of strike lock mode when standard BT mode is active.

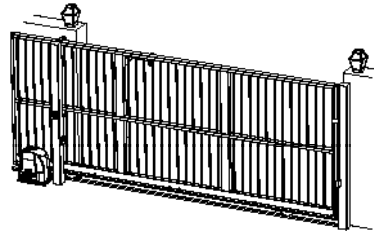

Action		Response		
Momentary BT trigger.		Auxiliary relay activates.	No buzzer tone.	
Half a second after the auxiliary relay has activated.		Gate begins opening.	No buzzer tone.	
After the preprogrammed relay on time.		Auxiliary relay deactivates and gate continues opening.	No buzzer tone.	
Gate reaches open position.		Gate stops.	No buzzer tone.	
Momentary BT trigger.		Gate begins closing.	No buzzer tone.	
At full closed position.		Gate stops.	No buzzer tone.	

User manual reference - Page 16	Auxiliary relay modes. Magnetic lock mode.	Basic operating features
------------------------------------	---	-----------------------------

With Magnetic lock mode selected, the auxiliary relay will activate, half a second before the gate opens and remain active until half a second after the gate has closed again.

Whenever a lock is installed with the system, a separate battery backed up power supply matching the lock load must be installed. Failure to do this can damage the charger and battery of the control unit.

Below is an example of magnetic lock mode when standard BT mode is active.

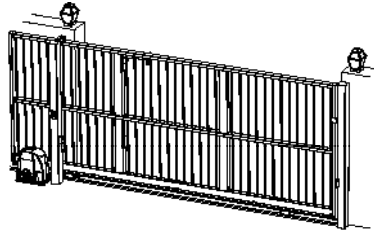

Action		Response		
Momentary BT trigger.		Auxiliary relay activates.	No buzzer tone.	
Half a second after the auxiliary relay has activated.		Gate begins opening.	No buzzer tone.	
Gate reaches open position.		Gate stops.	No buzzer tone.	
Momentary BT trigger.		Gate begins closing.	No buzzer tone.	
At full closed position.		Gate stops.	No buzzer tone.	
Half a second after gate has reached the full closed position.		Auxiliary relay deactivates.	No buzzer tone.	

Basic operating features	Auxiliary relay modes. Receiver relay mode.	User manual reference - Page 17
--------------------------	--	------------------------------------

With Receiver relay mode selected, the auxiliary relay will operate in exactly the same way as a single channel receiver would, whenever a transmitter button programmed into the "Relay" receiver function is pressed and released.

Latch mode. The transmitter must be released and pressed again to toggle the relay each time.

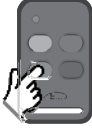
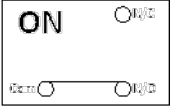
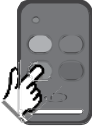
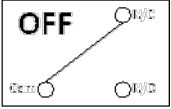
Action		Response		
Momentary relay trigger.		Auxiliary relay switches on.	No buzzer tones.	
Momentary relay trigger.		Auxiliary relay switches off.	No buzzer tones.	

One shot pulse mode. The transmitter must be released and pressed again to reactivate the relay each time.
--

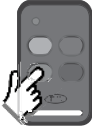
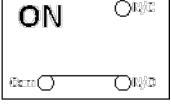
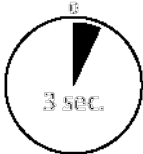
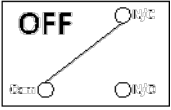
Action		Response		
Momentary relay trigger.		Auxiliary relay switches on.	No buzzer tones.	
After relay timer has timed out.		Auxiliary relay switches off.	No buzzer tones.	

With courtesy light mode selected, the auxiliary light will switch on as the gate begins opening and remain on for 3 minutes after the gate has closed.

The auxiliary relay can also be triggered to switch on without the gate opening by simply pressing and releasing any remote button programmed into the auxiliary relay function of the receiver.

Below is an example of courtesy light mode when standard BT mode is active.

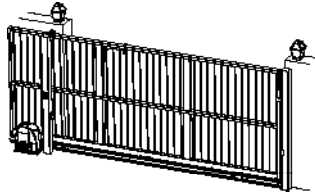

Action		Response		
Momentary BT trigger.		Auxiliary relay activates.	No buzzer tone.	
		Gate begins opening.		
Gate reaches open position.		Gate stops.	No buzzer tone.	
Momentary BT trigger.		Gate begins closing.	No buzzer tone.	
At full closed position.		Gate stops.	No buzzer tone.	
		Relay on timer begins counting down.		
After relay on timer timeout.		Auxiliary relay deactivates.	No buzzer tone.	

If any remote button programmed into the auxiliary relay function is pressed momentarily, the following will occur.

Auxiliary relay status	Action		Response		
	Momentary auxiliary relay trigger.		Auxiliary relay switches on for 1 hour.	No buzzer tone.	
	Momentary auxiliary relay trigger.		Auxiliary relay switches off.	No buzzer tone.	

Beam Tamper Alarm.

In cases where the safety beams have been tampered with, the safety protocols will still allow the gates to open but will not allow the gates to close. This safety feature can be turned into a security risk by anyone with ill intention. The beam tamper alarm feature gives you a early warning of any tampering that may have occurred while you were away from the property. If the gates are in the closed position and the safety beam input is trigger for longer than 20 seconds, then the auxiliary relay will become active in this mode. This would usually be connected to a visual warning device such as a light or to a zone on the household alarm system.

In the case of a light being used, on approach to the entrance the user is alerted to the attempt to compromise their security. Our advice is that the user not trigger the gates to open, in this situation, but rather to continue driving to their nearest armed response standby point or to the nearest police station. This way they can ask for an escort onto the property.

Beam tamper alarm mode is available in all modes of operation so long as a set of safety beams is installed.

Gate closed.

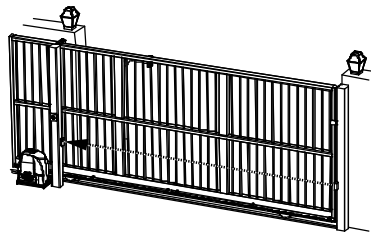

Action		Response		
Safety beam equipment tampered with while gates are in the closed position.		Auxiliary relay remains in standby status.		
20 seconds after safety beam equipment has been tampered with.		Auxiliary relay activates.		
Safety beam equipment returned to normal functioning status.		Auxiliary relay returns to standby.		

Gate forced open alarm.

In a case where the gate is physically lifted off its track and forced open, the auxiliary relay will immediately activate. The auxiliary relay will only reset when the gate is returned to normal secured condition in the closed position.

Action		Response		
Gate secured in the closed position. Standing by.		Auxiliary relay remains in standby status.		
Attempt to lift gate off track and force open.		Auxiliary relay activates.		
Gate resecured in the closed position. Standing by.		Auxiliary relay returns to standby.		

With positive close mode activated, the gate will surge onto the closed stopper after seeing the closed limit. This feature is useful when installing an electric lock or when trying to ensure an electric fencing gate contact always closes when the gate is in the closed position.

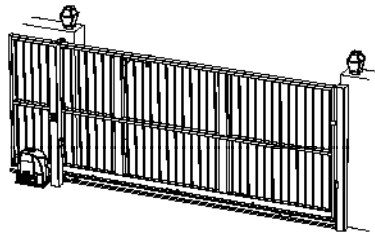

Action		Response		
Momentary BT trigger.		Gate begins opening.	No buzzer tones.	
At full open position.		Gate stops.	No buzzer tones.	
Momentary BT trigger.		Gate begins closing.	No buzzer tones.	
Momentary BT trigger.		Gate stops.	No buzzer tones.	
Momentary BT trigger.		Gate begins opening.	No buzzer tones.	
Momentary BT trigger.		Gate stops.	No buzzer tones.	
Momentary BT trigger.		Gate begins closing.	No buzzer tones.	
At full closed position.		Closed limit activates.	No buzzer tones.	
When the closed limit activates.		Gate continues to surge onto the mechanical closed stopper.	No buzzer tone.	

This feature is useful at times when access to the property needs to be disallowed to secondary level key holders, such as housekeepers or the garden service company, for extended periods of time. An example of when the holiday lock-out function would be useful is when the home owner is away on holiday. With holiday lock-out mode active, any trigger on any input will simply result in the control card beeping to indicate the gates are being kept locked intentionally. As soon as the holiday lock-out mode is deactivated, the system will resume normal operation.

Holiday lock-out will only work in the closed position.

Holiday lock-out is not available in condominium mode.

Gate must be closed to start.

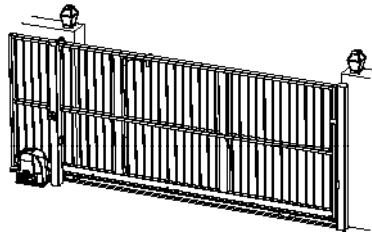

Action		Response		
Momentary trigger from any transmitter button programmed into holiday lock-out function.		Buzzer begins toning and status LED comes on.	x 5 sec. 	
BT button while buzzer is sounding to confirm that you want to activate holiday lock-out. If no BT button is pressed during this 5 second window, the holiday lock-out status will not change.		Buzzer and status LED beep/flash rapidly.	x 5 rapid. 	
Any BT or PED triggers.		Gate does not open. Buzzer, status LED.	x 5 rapid. 	
Momentary trigger from any transmitter button programmed into holiday lock-out function.		Buzzer begins toning and status LED comes on.	x 5 sec. 	
BT button while buzzer is sounding to confirm that you want to deactivate holiday lock-out. If no BT button is pressed during this 5 second window, the holiday lock-out status will not change.		Buzzer beeps, status LED reverts to gate running indication and gate begins opening.	x 1 	

Normal operation is now functional.

This feature is useful at times when the gate must be kept open for extended periods of time. When cutting the lawn on the pavement for instance. With Auto-close override/party mode active any trigger on any input will simply result in the control card beeping to indicate the gate is being kept open intentionally. As soon as auto-close override/party mode has been deactivated, the system will resume normal operation.

Auto-close override/party mode will work in any position except the closed position.

Auto-close override/party mode is not available in condominium mode.



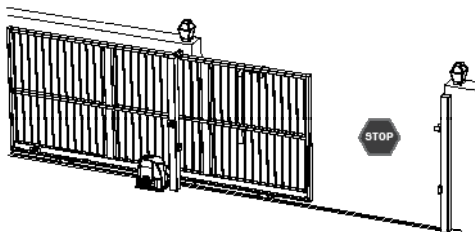

Gate in any position
except closed.

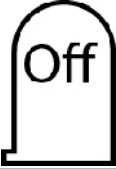
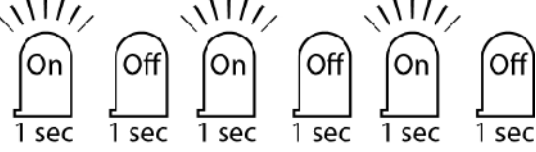
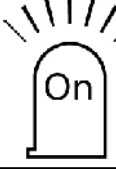

Action		Response		
Momentary trigger from any transmitter button programmed into holiday lock-out function.		Buzzer begins toning and status LED comes on.	x 5 sec. 	
BT button while buzzer is sounding to confirm that you want to activate Auto-close override/party mode. If no BT button is pressed during this 5 second window, the auto-close/party mode status will not change.		Buzzer and status LED beep/flash rapidly.	x 5 rapid. 	
Any BT or PED triggers.		Gate does not move. Buzzer, status LED beep/flash rapidly to confirm status.	x 5 rapid. 	
Momentary trigger from any transmitter button programmed into holiday lock-out function.		Buzzer begins toning and status LED comes on.	x 5 sec. 	
BT button while buzzer is sounding to confirm that you want to deactivate Auto-close override/party mode. If no BT button is pressed during this 5 second window, the Auto-close override/party mode status will not change.		Buzzer beeps, status LED reverts to gate running indication and gate begins closing.	x1 	

Normal operation is now functional.

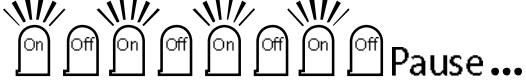
Status LED indications and buzzer guide.

Description	Visual confirmation	Buzzer	Reason
Static off.		None	Gate fully closed.
Flashing slow 1 second on and 1 second off.		None	Gate running normally.
Static on.		None	Gate open.
2 x 0,5s flashes followed by a 2 second pause.		1 x 1 second beep every 15 seconds for 5 minutes after last gate transaction.	AC mains off. Restore AC as soon as possible.
4 x 0,5s flashes followed by a 2 second pause.		1 x 1 second beep every 15 seconds for 5 minutes after last gate transaction.	Battery low. Allow at least 8 – 10hr uninterrupted charge before checking again.
5 x 0,125s rapid flashes each time a trigger is received.		Mimics LED.	A lock-out mode is active. See Holiday Lock-out and Party Mode in advanced operating features pages.

Display definitions and troubleshooting guide.

Displayed on screen.	Definition.	Solution.
In normal operating mode.		
rdy	Unit is standing by and ready for next instruction.	Trigger to run a required routine.
ac	Charger powered down due to Vac mains interruption.	Check 220VAC or 29Vac supply to the unit. Check 500mA fast blow fuse in the 220Vac connector.
Bat	Battery is either disconnected or discharged.	Check the 10A fuse in the battery lead. Allow 8-10 hours uninterrupted charge before trying to operate the unit again. If the battery has not recovered after this, then replace the battery.
rel	Gearbox manual release is in released (Manual) position.	Lower the release lever to engage gearbox. Test manual release lever reed switch. Check that the manual release lever magnet has not been dislodged.
i rb	Infra-red beams circuit is being triggered.	Remove obstruction from the path of the safety beams. Check that beams are powered and functioning properly. Ensure the safety beam circuit end of line resistor has been installed properly as per this manual.
Hol	Control card is in Holiday Lock-out mode.	Follow the steps on page 42 to deactivate Holiday Lock-out.
par	Control card is in Party mode.	Follow the steps on page 43 to deactivate Party mode.
col	Multiple collision lock-out active.	See page 32 and "Selecting a safety level" on page 20.
for	Safety overload triggered by physical overload.	See page 32 and "Selecting a safety level" on page 20.
ref	Referencing the gate closed position.	See "Referencing the closed position" on page 10.
e-l	Failure to see the closed limit.	See Installing the limit actuator on page 16.
opn	Gate is open.	Trigger gate to close.
pr9	Control card is in Programming mode.	Press and release X to exit programming mode.
e1	Revolution counter/encoder failure.	Ensure control card is fastened down correctly and that the ring magnet is installed correctly in place atop the motor shaft.
e3	Motor is disconnected, motor fuse is fused or electric motor is faulty.	Ensure the motor is connected correctly. Test the 10A motor fuse. Test the electric motor by disconnecting it from the control card and running it on a battery directly.
In programming mode.		
abt	Procedure aborted via the "X" button.	Begin the procedure again.
dne	Procedure completed.	Continue on to another programming option or exit programming.
e-l	Closed limit not installed correctly.	See Installing the limit actuator on page 16.
for	While buzzer beeps 20 times. Excessive gate resistance.	Repair gate rolling load, so that it remains below the rated load specified on page 4.
ful	Receiver memory is full.	Delete any user addresses no longer in use.
to	Time out error while programming a remote.	Begin transmitting with the remote before pressing set. Remote maybe damaged or faulty. Ensure the remote does indeed transmit.
dec	Decoding error.	The remote does not use a format that is compatible with the receiver.

WARRANTY:

1. All goods manufactured by ET NICE (Pty) Ltd carry a 12 month factory warranty from date of invoice.
2. All goods are warranted to be free of faulty components and manufacturing defects.
3. Faulty goods will be repaired or replaced at the sole discretion of ET NICE (Pty) Ltd free of charge.
4. This warranty is subject to the goods being returned to the premises of ET NICE (Pty) Ltd.
5. The carriage of goods is for the customer's account.
6. This warranty is only valid if the correct installation and application of goods, as laid out in the applicable documentation accompanying said goods, is adhered to.
7. All warranty claims must be accompanied by the original invoice.
8. All claims made by the end user must be directed to their respective service provider/installer.

The following conditions will disqualify this product from the warranty as laid out above. These conditions are non- negotiable.

1. Any unauthorized non-manufacturer modifications to the product or components thereof.
2. Any modification to the installation methods described in the installation instructions.
3. Any application or use of the product other than the intended use and application described in the product documentation.

The following items are not included in the warranty or they carry a special warranty condition of their own.

1. The battery (Limited 6 month warranty)
2. The motor brushes.
3. Damage resultant of wind and other climatic influences such as lightning strikes.
4. Damage due to high voltage surges on the household mains or short circuiting of the gates to the electric fencing.
5. Damage due to infestation i.e. Ants nesting...
6. Water damage. It is the responsibility of the installer to ensure the product is installed in a location that is protected from water ingress. The ingress protection rating is specified in the accompanying documentation. Housings that require that cable entries are made by the installer do not carry an ex-factory ingress protection rating as it is the responsibility of the installer to seal the cable entry points after installation of the cabling.