

€ Price List
Preis Liste 2023



konusulan kalite...
the spoken quality...
qualität über die man spricht...

    AKKO Metalworking Tools

Yenilikler için bizi takip edin!
Follow us for news!
Für Neuheiten bitte uns folgen!



www.akko.com.tr



TS EN ISO 9001:2015





1986 yılında Abdullah KARAKUŞ tarafından kurulan AKKO Makina Sanayi ve Ticaret A.Ş. Tornalama Takımları, Diş ve Kanal Açma Takımları, Delik Delme Takımları, Frezeleme Takımları ve talebe yönelik Özel Takımları üretmektedir. Şu an 39.000 m²' ye yakın bir alanda Türkiye, Japonya, Almanya, İsviçre gibi ülkelerin ürettikleri son teknoloji tezgah ve ekipmanlarıyla yıllık 400.000 adet üretim kapasitesiyle, standart 10.000 çeşit takım üretimi yapmaktadır. Avrupa, Asya, Afrika, Güney Amerika, Kuzey Amerika ve Orta Doğu kıtalarında şimdilik 90 ülkeye ürün sevkiyatına devam etmektedir. Minimum 300.000 adet üretilmiş ürün stoklarında mevcut bulunmaktadır. Firma için özel üretilen çelik hammadde işleme girer ve bütün üretim süreci kendi bünyesinde gerçekleşmektedir. Çeliğin işlenmesi, ısıl işlemi, üzerindeki kaplama ve her türlü üretim operasyonları bir entegre tesis olan AKKO'da yapılmaktadır.

We as AKKO Makina Sanayi ve Ticaret A.Ş. which has been founded by Abdullah KARAKUŞ in 1986, produces Turning Tool Holders, Threading and Grooving Tool Holders, U-Drills, Milling Tool Holders, and Precision Tool Holders (OEM Tool Holders) on-demand. We produce standard 10.000 kinds of tool holders with a production capacity of 400.000 pieces per annum in an area of about 39.000 square meters. We are going on exporting to 90 countries including European, Asian, African, South American Countries, North American Countries, and Middle East Countries. We keep ready about 300.000 pieces produced products in our stock. Steel Raw materials that we make produced especially for us are delivered our factory and all production process are made in our factory. All kinds of operations from machining of steel to heat treatment and coating on our tools are made in our integrated factory AKKO.

Wir die Firma AKKO Makina Sanayi ve Ticaret A.Ş. welches durch Herrn Abdullah Karakuş in 1986 gegründet wurde, produzieren Dreh-, Gewinde- und Stechwerkzeuge für Wendeschneidplatten. Ebenso gehören Wendeplattenbohrer, Wendeplattenfräser und Sonderwerkzeuge nach Anfrage für Wendeplatten zum Lieferprogramm. Alle Werkzeuge sind auch als OEM-Version lieferbar. Wir produzieren 10.000 standart Arten der Werkzeughalter mit einer Produktionskapazität von 400.000 Stücken per anum auf einer Fläche von 39.000 quadrat meter. Wir exportieren unsere eigenproduzierten Ware nach 90 Ländern, Europa, Asien, Afrika, Süd amerikanische Länder, Mittlerer Osten. Lieferbereit halten wir 300.000 Stück produzierte Produkte auf Lager. Das eingesetzte Rohmaterial wird speziell für unsere Firma produziert. Alle Produktionsschritte werden auf unseren eigenen Anlagen veranlasst. Alle einzelnen Produktionsschritte wie z.B. mechanische Bearbeitung, Wärmebehandlung und Beschichtung unserer Werkzeuge erfolgen auf unseren eigenen Maschinenanlagen.

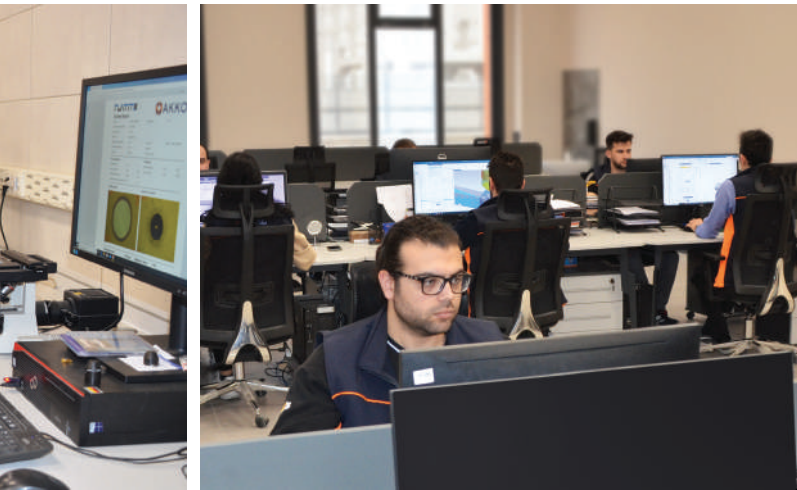

POLY-V GROOVING INSERTS and TOOLHOLDERS / POLY-V EINSTECHPLATTEN UND WERKZEUGE		PRICE / PREIS	
	ADKT-T12P-R / L	ADKT-T12P-R/L-1616-T5	100,00 €
	T12...	ADKT-T12P-R/L-2020-T5	104,00 €
		ADKT-T12P-R/L-2525-T5	108,00 €
		ADKT-T12P-R/L-3232-T5	129,00 €
	T12.10.0234.PJ.L		38,00 €
	T12.10.0234.PJ.R		38,00 €
	T12.10.0356.PK.L		41,00 €
	T12.10.0356.PK.R		41,00 €
	T12.10.0470.PL.R		44,00 €
	T30.07.0234.PJ.x2		50,00 €
	T30.07.0356.PK.x2		50,00 €
	ATPVK	ATPVK 2020 K2.34X4	155,00 €
	B26.07.0234PJ.x4 B26.07.0356PK.x4 B26.07.0470PL.x3	ATPVK 2525 M2.34X4	156,00 €
		ATPVK 3232 P2.34X4	180,00 €
		ATPVK 2020 K3.56X4	155,00 €
		ATPVK 2525 M3.56X4	156,00 €
		ATPVK 3232 P3.56X4	180,00 €
		ATPVK 2020 K4.7X3	141,00 €
		ATPVK 2525 M4.7X3	142,00 €
		ATPVK 3232 P4.7X3	164,00 €
	B26.07.0234.PJx4		59,00 €
	B26.07.0356.PKx4		59,00 €
	B26.07.0470.PLx3		54,00 €
INSERTS and TOOLHOLDERS FOR GROOVING CORNER RELIEFS / WENDESCHNEIDPLATTEN UND WERKZEUGE FÜR AXIAL FREISTICHE		PRICE / PREIS	
	AAUT-T20-R / L	AAUT-T20-R/L-1616-45	93,00 €
	T20...	AAUT-T20-R/L-2020-45	94,00 €
		AAUT-T20-R/L-2525-45	96,00 €
	T20.00.0815.45.04R/L		42,00 €
	T20.00.1220.45.05R/L		42,00 €
	T20.00.2024.45.06R/L		42,00 €
	T20.00.1220.45.10R/L		54,00 €

VALVE SEAT INSERTS and TOOLHOLDERS / WENDESCHNEIDPLATTEN UND WERKZEUGE FÜR VENTILSITZBEARBEITUNG **PRICE / PREIS**

	VST	VST-B11-2842	105,00 €		
	B11...	VST-B11-4058	112,00 €		
	VST	VST-B11-1830	90,00 €		
	B11...				
	VST	VST-B11-2032	160,00 €		
	B11...	VST-B11-2434	110,00 €		
	B11013		45,00 €		
	B11003	33,00 €		B11039	33,00 €
	B11004	33,00 €		B11040	33,00 €
	B11005	33,00 €		B11042	33,00 €
	B11006	33,00 €		B11043	33,00 €
	B11007	33,00 €		B11044	33,00 €
	B11008	33,00 €		B11045	33,00 €
	B11009	33,00 €		B11046	33,00 €
	B11010	33,00 €		B11047	33,00 €
	B11011	33,00 €		B11048	33,00 €
	B11012	33,00 €		B11049	33,00 €
	B11014	33,00 €		B11050	33,00 €
	B11016	33,00 €		B11051	33,00 €
	B11017	33,00 €		B11052	33,00 €
	B11018	33,00 €		B11053	33,00 €
	B11019	33,00 €		B11054	33,00 €
	B11020	45,00 €		B11055	33,00 €
	B11021	33,00 €		B11056	33,00 €
	B11022	33,00 €		B11057	33,00 €
	B11029	33,00 €		B11058	33,00 €
	B11030	33,00 €		B11061	33,00 €
	B11031	33,00 €		B11062	33,00 €
	B11032	33,00 €		B11063	33,00 €
	B11033	33,00 €		B11064	33,00 €
	B11034	33,00 €		B11065	33,00 €
	B11035	33,00 €		B11066	33,00 €
	B11036	33,00 €		B11067	33,00 €
	B11037	33,00 €		B11069	33,00 €
	B11038	33,00 €			

VALVE SEAT INSERTS and TOOLHOLDERS / WENDESCHNEIDPLATTEN UND WERKZEUGE FÜR VENTILSITZBEARBEITUNG **PRICE / PREIS**

	B11015	23,00 €
	B11023	45,00 €
	B11024	23,00 €
	B11025	23,00 €
	B11026	23,00 €
	B11027	23,00 €
	B11028	23,00 €

WHIRLING INSERTS and TOOLHOLDERS / WENDESCHNEIDPLATTEN UND WERKZEUGHALTER ZUM GEWINDEWIRBELN

	MACHINE MASCHINE	AGGREGATE WHIRLING UNIT WRBELSPINDEL	WHIRLING RING CODE WIRBELRING	CUTTING INSERT WENDE PLATTE	PRICE / PREIS
	STAR	5914 72 00/68172	ATW-301-T09-D1240-Z06	T09...	316,00 €
		BTW1000	ATW-302-T09-D1233-Z06	T09....	316,00 €
		GSW101	ATW-303-T09-D0620-Z06	T09....	316,00 €
	CITIZEN	MWS101/KSW101			
		LSW101/BSW215/ LSW215315	ATW-304-T09-D1240-Z06	T09...	316,00 €
		LSW424	ATW-305-T09-D1245-Z06	T09....	316,00 €
	TORNOS	306101/307087	ATW-306-T09-D1240-Z06	T09....	328,00 €
		417617	ATW-307-T09-D1250-Z06	T09....	340,00 €
	WTO	TN762004	ATW-308-T09-D1142-Z06	T09....	316,00 €
		TN762006	ATW-309-T09-D2054-Z08	T09....	362,00 €
		3234 Y342	ATW-310-T09-D1252-Z06	T09....	340,00 €
		3268 Y452	ATW-311-T09-D1252-Z06	T09....	328,00 €
	TSUGAMI	3268 Y271	ATW-312-T09-D1252-Z06	T09....	328,00 €
		3214 Y342	ATW-313-T09-D1650-Z06	T09...	340,00 €
		3234 Y342	ATW-314-T09-D2052-Z06	T09....	340,00 €
		3281-Y451	ATW-316-T09-D1252-Z06	T09....	328,00 €
HANWHA	MADAULA	ATW-315-T09-D1245-Z06	T09....	328,00 €	

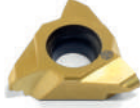
	T09.HA150.D12-VK15U01	48,00 €
	T09.HA200.D12-VK15U01	48,00 €
	T09.HA270.D12-VK15U01	48,00 €
	T09.HA350.D12-VK15U01	48,00 €
	T09.HA400.D12-VK15U01	48,00 €
	T09.HA450.D12-VK15U01	48,00 €
	T09.HA500.D12-VK15U01	48,00 €
	T09.HB400.D12-VK15U01	48,00 €
	T09.HB650.D12-VK15U01	48,00 €
	T09.HC290.D12-VK15U01	48,00 €
	T09.HC350.D12-VK15U01	48,00 €
	T09.HC390.D12-VK15U01	48,00 €
	T09.HC420.D12-VK15U01	48,00 €
	T09.HD400.D12-VK15U01	48,00 €
	T09.HD450.D12-VK15U01	48,00 €
	T09.M200.D12-VK15U01	48,00 €
	T09.M250.D12-VK15U01	48,00 €
	T09.M300.D12-VK15U01	48,00 €
	T09.M350.D12-VK15U01	48,00 €
	T09.M400.D12-VK15U01	48,00 €
	T09.M500.D12-VK15U01	48,00 €
	T09.M600.D12-VK15U01	48,00 €
	T09.M700.D12-VK15U01	48,00 €
	T09.M800.D12-VK15U01	48,00 €

THREAD MILLING INSERTS AND TOOLHOLDER / GEWINDEFÄHRERWERKZEUGE

	CODE / TYP	INSERT TYPE	TOOL DIMENSIONS (mm) MAB			PRICE / PREIS
			Pitch	H	T	
	ADTE.14.075		0.75	7.5	3.1	32,00 €
	ADTE.14.100		1.00	7.5	3.1	32,00 €
	ADTE.14.125		1.25	7.5	3.1	32,00 €
	ADTE.14.150		1.50	7.5	3.1	32,00 €
	ADTE.14.175	C14	1.75	7.5	3.1	32,00 €
	ADTE.14.200		2.00	7.5	3.1	32,00 €
	ADTE.14.250		2.50	7.5	3.1	32,00 €
	ADTE.21.100		1.00	12	4.7	40,00 €
	ADTE.21.150	C21	1.50	12	4.7	40,00 €
	ADTE.21.200		2.00	12	4.7	40,00 €
	ADTE.21.250		2.50	12	4.7	40,00 €
	ADTE.21.300		3.00	12	4.7	40,00 €
	ADTI.14.050		0.5	7.5	3.1	32,00 €
	ADTI.14.075		0.75	7.5	3.1	32,00 €
	ADTI.14.100	C14	1.00	7.5	3.1	32,00 €
	ADTI.14.125		1.25	7.5	3.1	32,00 €
	ADTI.14.150		1.50	7.5	3.1	32,00 €
	ADTI.14.175		1.75	7.5	3.1	32,00 €
	ADTI.14.200		2.00	7.5	3.1	32,00 €
	ADTI.14.250		2.50	7.5	3.1	32,00 €
	ADTI.21.100		1.00	12	4.7	40,00 €
	ADTI.21.150		1.50	12	4.7	40,00 €
	ADTI.21.175	C21	1.75	12	4.7	40,00 €
	ADTI.21.200		2.00	12	4.7	40,00 €
	ADTI.21.250		2.50	12	4.7	40,00 €
	ADTI.21.300		3.00	12	4.7	40,00 €
	ADTI.21.350		3.5	12	4.7	40,00 €

TORX-ALLEN / PUNCH - BROACH SET / TORX WINKELSCHRAUBENDEHER WERKZEUGE

	CODE / TYP	SOCKET NUMBER	INSERT DIMENSIONS (mm) MAB				PRICE / PREIS
			ØD	H	A	B	
	APTX-006	6	4	1.82	1.75	1.27	42,00 €
	APTX-008	8	4	3.05	2.4	1.75	42,00 €
	APTX-010	10	4	3.56	2.8	2.05	42,00 €
	APTX-015	15	4	3.81	3.35	2.4	42,00 €
	APTX-020	20	5	4.07	3.95	2.85	42,00 €
	APTX-025	25	5	4.45	4.5	3.25	42,00 €
	APTX-030	30	7	4.95	5.6	4.05	42,00 €
	APTX-040	40	7	5.59	6.75	4.85	42,00 €
	APTX-045	45	9	6.22	7.93	5.64	42,00 €
	APTX-050	50	10	6.48	8.95	6.45	42,00 €

Ordering Example / Beispiel Bestellformular: 1pcs. ADTE.14.075

TORX-ALLEN / PUNCH - BROACH SET / TORX WINKELSCHRAUBENDEHER WERKZEUGE

	CODE / TYP	SOCKET NUMBER	INSERT DIMENSIONS (mm) MAB		PRICE / PREIS
			ØD	H	
	APHX-0016	M1,6	4	3	32,00 €
	APHX-0020	M2,0	4	4	32,00 €
	APHX-0025	M2,5	4	5	32,00 €
	APHX-0030	M3,0	4	6	32,00 €
	APHX-0035	M3,5	4	6	32,00 €
	APHX-0040	M4,0	4	8	32,00 €
	APHX-0045	M4,5	5	9	32,00 €
	APHX-0050	M5,0	5	10	32,00 €
	APHX-0060	M6,0	6	11	32,00 €
	APHX-0080	M8,0	7	12	32,00 €
	APHX-0100	M10	10	12	32,00 €
	APHX-0120	M12	12	12	32,00 €
	APHX-0140	M14	14	16	32,00 €
	APHX-0160	M16	17	18	32,00 €
APHX-0200	M20	21	20	32,00 €	

	CODE / TYP	SOCKET NUMBER	INSERT DIMENSIONS (mm) MAB		PRICE / PREIS
			ØD	L2	
	AKTX-006	6	6	3,0	42,00 €
	AKTX-008	8	6	4,0	42,00 €
	AKTX-010	10	6	4,5	42,00 €
	AKTX-015	15	6	4,5	42,00 €
	AKTX-020	20	6	5,0	42,00 €
	AKTX-030	30	6	6,0	42,00 €
	AKTX-040	40	6	6,5	42,00 €
	AKTX-045	45	6	7,0	42,00 €

	CODE / TYP	SOCKET NUMBER	INSERT DIMENSIONS (mm) MAB					PRICE / PREIS
			ØD	r	L2	LH	Tmax	
	AKHX-001-001	1	3	0,05	2	2	0,3	42,00 €
	AKHX-002-002	2	3	0,05	3	3	0,6	42,00 €
	AKHX-003-003	3	4	0,05	6	6	1	42,00 €
	AKHX-004-006	4-6	5	0,10	8	8	1	42,00 €
	AKHX-007-012	7-12	6	0,15	12	12	1,5	42,00 €
	AKHX-013-018	13-18	9	0,20	15	15	2	42,00 €

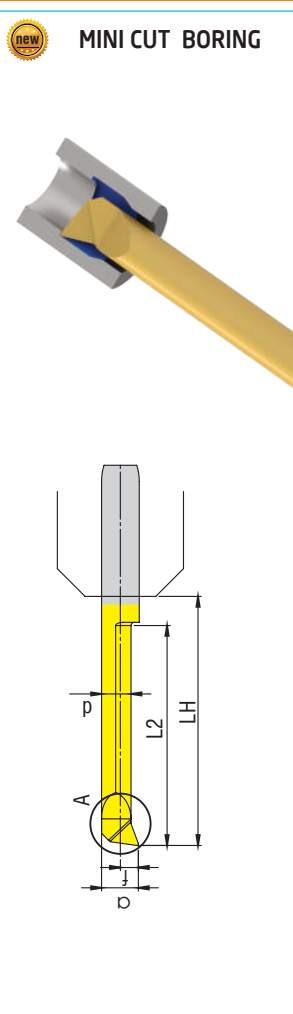

MINI CUT TOOLS / MINI CUT WERKZEUGE

	CODE / TYP	TOOL DIMENSIONS (mm) MAB									PRICE / PREIS
		L2	Ødmin	R	a	d	f	LH	tmax	ØD	
 <p>MINI CUT BORING</p>	APB.04.102.015	10,2	4,2	0.15	3.95	3.45	1.95	13	0.3	4	25,00 €
	APB.04.152.015	15.20	4.2	0.15	3.95	3.45	1.95	18	0.3	4	26,00 €
	APB.04.203.015	20.30	4.2	0.15	3.95	3.45	1.95	23	0.3	4	30,00 €
	APB.04.254.015	25.40	4.2	0.15	3.95	3.45	1.95	28	0.3	4	31,00 €
	APB.04.305.015	30.50	4.2	0.15	3.95	3.45	1.95	33	0.3	4	36,00 €
	APB.04.356.015	35.60	4.2	0.15	3.95	3.45	1.95	38	0.3	4	38,00 €
	APB.05.102.020	10,2	5,2	0.2	4.95	4.95	2.95	13	0.5	5	22,00 €
	APB.05.152.020	15.20	5.2	0.2	4.95	4.95	2.95	18	0.5	5	23,00 €
	APB.05.203.020	20.30	5.2	0.2	4.95	4.95	2.95	23	0.5	5	28,00 €
	APB.05.254.020	25.40	5.2	0.2	4.95	4.95	2.95	28	0.5	5	31,00 €
	APB.05.305.020	30.50	5.2	0.2	4.95	4.95	2.95	33	0.5	5	35,00 €
	APB.05.356.020	35.60	5.2	0.2	4.95	4.95	2.95	38	0.5	5	38,00 €
	APB.05.406.020	40.60	5.2	0.2	4.95	4.95	2.95	43	0.5	5	21,00 €
	APB.06.102.020	10,2	6,2	0.2	5.95	5.25	2.95	13	0.5	6	22,00 €
	APB.06.152.020	15.20	6.2	0.2	5.95	5.25	2.95	18	0.5	6	24,00 €
	APB.06.203.020	20.30	6.2	0.2	5.95	5.25	2.95	23	0.5	6	28,00 €
	APB.06.254.020	25.40	6.2	0.2	5.95	5.25	2.95	28	0.5	6	31,00 €
	APB.06.305.020	30.50	6.2	0.2	5.95	5.25	2.95	33	0.5	6	35,00 €
	APB.06.356.020	35.60	6.2	0.2	5.95	5.25	2.95	38	0.5	6	39,00 €
	APB.06.406.020	40.60	6.2	0.2	5.95	5.25	2.95	43	0.5	6	44,00 €
APB.06.508.020	50.80	6.2	0.2	5.95	5.25	2.95	53	0.5	6	53,00 €	
APB.07.254.020	25.40	7.2	0.2	6.95	6.25	3.45	28	0.5	7	34,00 €	
APB.07.305.020	30.50	7.2	0.2	6.95	6.25	3.45	33	0.5	7	38,00 €	
APB.07.356.020	35.60	7.2	0.2	6.95	6.25	3.45	38	0.5	7	42,00 €	
APB.07.406.020	40.60	7.2	0.2	6.95	6.25	3.45	43	0.5	7	45,00 €	
APB.07.508.020	50.80	7.2	0.2	6.95	6.25	3.45	53	0.5	7	53,00 €	
APB.07.608.020	60.80	7.2	0.2	6.95	6.25	3.45	63	0.5	7	60,00 €	

MINI CUT TOOLS / MINI CUT WERKZEUGE

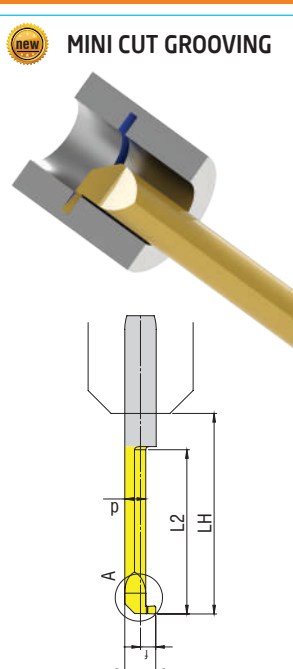
	CODE / TYP	TOOL DIMENSIONS (mm) MAB									PRICE / PREIS	
		W	L2	Ødmin	R	a	d	f	LH	tmax		ØD
 <p>MINI CUT GROOVING</p>	APG04.080.102	0.8	10,2	4,2	-	3.95	2,95	1.95	13	0,8	4	25,00 €
	APG04.080.152	0.8	15.2	4.2	-	3.95	2,95	1.95	18	0,8	4	29,00 €
	APG04.080.203	0.8	20.3	4.2	-	3.95	2,95	1.95	23	0,8	4	32,00 €
	APG04.080.254	0.8	25.4	4.2	-	3.95	2,95	1.95	28	0,8	4	36,00 €
	APG04.100.102	1,0	10,2	4,2	-	3.95	2,95	1.95	13	1,0	4	25,00 €
	APG04.100.152	1,0	15.2	4.2	-	3.95	2,95	1.95	18	1,0	4	28,00 €
	APG04.100.203	1,0	20.3	4.2	-	3.95	2,95	1.95	23	1,0	4	32,00 €
	APG05.079.102	0,79	10,2	5,2	-	4.95	3,75	2,45	13	1,0	5	24,00 €
	APG05.079.152	0,79	15.2	5.2	-	4.95	3,75	2,45	18	1,0	5	28,00 €
	APG05.079.203	0,79	20.3	5.2	-	4.95	3,75	2,45	23	1,0	5	32,00 €
	APG05.079.254	0,79	25.4	5.2	-	4.95	3,75	2,45	28	1,0	5	36,00 €
	APG05.079.305	0,79	30.5	5.2	-	4.95	3,75	2,45	33	1,0	5	40,00 €
	APG05.079.356	0,79	35.6	5.2	-	4.95	3,75	2,45	38	1,0	5	44,00 €
	APG05.100.102	1,0	10,2	5,2	-	4.95	3,75	2,45	13	1,0	5	24,00 €
	APG05.100.152	1,0	15.2	5.2	-	4.95	3,75	2,45	18	1,0	5	27,00 €
	APG05.100.203	1,0	20.3	5.2	-	4.95	3,75	2,45	23	1,0	5	31,00 €
	APG05.100.254	1,0	25.4	5.2	-	4.95	3,75	2,45	28	1,0	5	35,00 €
	APG05.100.305	1,0	30.5	5.2	-	4.95	3,75	2,45	33	1,0	5	39,00 €
	APG05.100.356	1,0	35,6	5,2	-	4,95	3,75	2,45	38	1,0	5	44,00 €

MINI CUT TOOLS / MINI CUT WERKZEUGE

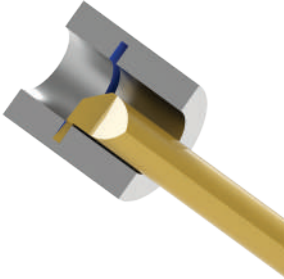
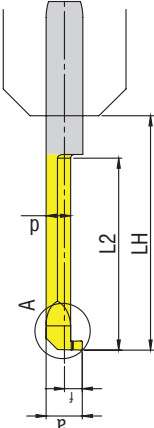
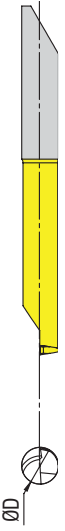
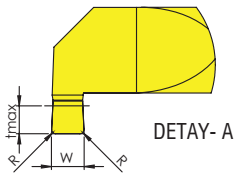
	CODE / TYP	TOOL DIMENSIONS (mm) MAB										PRICE / PREIS
		W	L2	Ødmin	R	a	d	f	LH	tmax	ØD	
   	APG06.117.152	1.17	15.2	6.2	-	5.95	3.95	2.95	18	1.8	6	29,00 €
	APG06.117.203	1.17	20.3	6.2	-	5.95	3.95	2.95	23	1.8	6	32,00 €
	APG06.117.254	1.17	25.4	6.2	-	5.95	3.95	2.95	28	1.8	6	36,00 €
	APG06.117.305	1.17	30.5	6.2	-	5.95	3.95	2.95	33	1.8	6	39,00 €
	APG06.117.356	1.17	35.6	6.2	-	5.95	3.95	2.95	38	1.8	6	44,00 €
	APG06.117.406	1.17	40.6	6.2	-	5.95	3.95	2.95	43	1.8	6	48,00 €
	APG06.150.102	1.5	10.2	6.2	-	5.95	3.95	2.95	13	1.8	6	24,00 €
	APG06.150.152	1.5	15.2	6.2	-	5.95	3.95	2.95	18	1.8	6	28,00 €
	APG06.150.203	1.5	20.3	6.2	-	5.95	3.95	2.95	23	1.8	6	31,00 €
	APG06.150.254	1.5	25.4	6.2	-	5.95	3.95	2.95	28	1.8	6	35,00 €
	APG06.150.305	1.5	30.5	6.2	-	5.95	3.95	2.95	33	1.8	6	39,00 €
	APG06.150.356	1.5	35.6	6.2	-	5.95	3.95	2.95	38	1.8	6	43,00 €
	APG06.157.102	1.57	10.2	6.2	-	5.95	3.95	2.95	13	1.8	6	25,00 €
	APG06.157.152	1.57	15.2	6.2	-	5.95	3.95	2.95	18	1.8	6	29,00 €
	APG06.157.203	1.57	20.3	6.2	-	5.95	3.95	2.95	23	1.8	6	33,00 €
	APG06.157.254	1.57	25.4	6.2	-	5.95	3.95	2.95	28	1.8	6	37,00 €
	APG06.157.305	1.57	30.5	6.2	-	5.95	3.95	2.95	33	1.8	6	40,00 €
	APG06.157.356	1.57	35.6	6.2	-	5.95	3.95	2.95	38	1.8	6	44,00 €
	APG06.157.406	1.57	40.6	6.2	-	5.95	3.95	2.95	43	1.8	6	48,00 €
	APG06.198.102	1.98	10.2	6.2	-	5.95	3.95	2.95	13	1.8	6	26,00 €
	APG06.198.152	1.98	15.2	6.2	-	5.95	3.95	2.95	18	1.8	6	30,00 €
	APG06.198.203	1.98	20.3	6.2	-	5.95	3.95	2.95	23	1.8	6	34,00 €
	APG06.198.254	1.98	25.4	6.2	-	5.95	3.95	2.95	28	1.8	6	37,00 €
	APG06.198.305	1.98	30.5	6.2	-	5.95	3.95	2.95	33	1.8	6	41,00 €
	APG06.198.356	1.98	35.6	6.2	-	5.95	3.95	2.95	38	1.8	6	42,00 €
	APG06.200.102	2.0	10.2	6.2	-	5.95	3.95	2.95	13	1.8	6	24,00 €
	APG06.200.152	2.0	15.2	6.2	-	5.95	3.95	2.95	18	1.8	6	28,00 €
	APG06.200.203	2.0	20.3	6.2	-	5.95	3.95	2.95	23	1.8	6	31,00 €
	APG06.200.254	2.0	25.4	6.2	-	5.95	3.95	2.95	28	1.8	6	35,00 €
	APG06.200.356	2.0	35.6	6.2	-	5.95	3.95	2.95	38	1.8	6	39,00 €
	APG07.079.102	0.79	10.2	7.2	-	6.95	4.25	3.45	13	2.5	7	26,00 €
	APG07.079.152	0.79	15.2	7.2	-	6.95	4.25	3.45	18	2.5	7	31,00 €
	APG07.079.203	0.79	20.3	7.2	-	6.95	4.25	3.45	23	2.5	7	34,00 €
APG07.079.254	0.79	25.4	7.2	-	6.95	4.25	3.45	28	2.5	7	37,00 €	
APG07.079.305	0.79	30.5	7.2	-	6.95	4.25	3.45	33	2.5	7	41,00 €	
APG07.079.356	0.79	35.6	7.2	-	6.95	4.25	3.45	38	2.5	7	46,00 €	
APG07.079.406	0.79	40.6	7.2	-	6.95	4.25	3.45	43	2.5	7	49,00 €	
APG07.100.102	1.0	10.2	7.2	-	6.95	4.25	3.45	13	2.5	7	25,00 €	
APG07.100.152	1.0	15.2	7.2	-	6.95	4.25	3.45	18	2.5	7	30,00 €	
APG07.100.203	1.0	20.3	7.2	-	6.95	4.25	3.45	23	2.5	7	33,00 €	
APG07.100.254	1.0	25.4	7.2	-	6.95	4.25	3.45	28	2.5	7	38,00 €	

MINI CUT TOOLS / MINI CUT WERKZEUGE

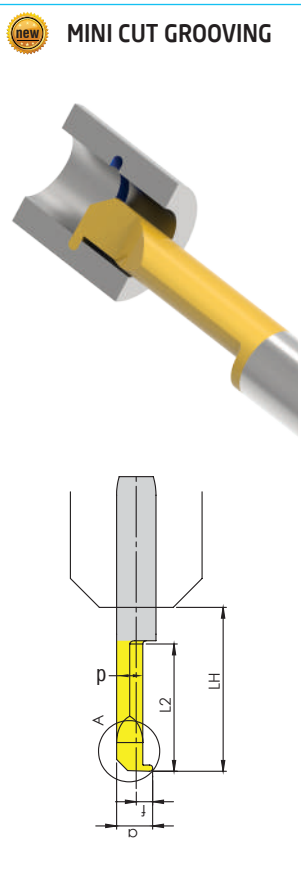
	CODE / TYP	TOOL DIMENSIONS (mm) MAB										PRICE / PREIS
		W	L2	Ødmin	R	a	d	f	LH	tmax	ØD	
 <p>MINI CUT GROOVING</p>	APG04.100.152.R050	1,0	15,2	4,2	0,5	3,95	2,95	1,95	18,0	0,8	4	30,00 €
	APG04.117.152.R0585	1,17	15,2	4,2	0,585	3,95	2,95	1,95	18,0	0,8	4	29,00 €
	APG05.100.203.R050	1,0	20,3	5,2	0,5	4,95	3,75	2,45	23,0	1,0	5	30,00 €
	APG05.117.203.R0585	1,17	20,3	5,2	0,585	4,95	3,75	2,45	23,0	1,0	5	31,00 €
	APG05.150.203.R075	1,5	20,3	5,2	0,75	4,95	3,75	2,45	23,0	1,0	5	31,00 €
	APG05.1574.203.R0787	1,574	20,3	5,2	0,787	4,95	3,75	2,45	23,0	1,0	5	31,00 €
	APG05.1626.203.R0813	1,626	20,3	5,2	0,813	4,95	3,75	2,45	23,0	1,0	5	31,00 €
	APG05.198.203.R099	1,98	20,3	5,2	0,99	4,95	3,75	2,45	23,0	1,0	5	30,00 €
	APG05.200.203.R100	2,0	20,3	5,2	1,0	4,95	3,75	2,45	23,0	1,0	5	31,00 €
	APG06.100.254.R050	1,0	25,4	6,2	0,5	5,95	3,95	2,95	28,0	1,8	6	34,00 €
	APG06.117.254.R0585	1,17	25,4	6,2	0,585	5,95	3,95	2,95	28,0	1,8	6	30,00 €
	APG06.150.254.R075	1,5	25,4	6,2	0,75	5,95	3,95	2,95	28,0	1,8	6	35,00 €
	APG06.1574.254.R0787	1,574	25,4	6,2	0,787	5,95	3,95	2,95	28,0	1,8	6	32,00 €
	APG06.1626.254.R0813	1,626	25,4	6,2	0,813	5,95	3,95	2,95	28,0	1,8	6	32,00 €
	APG06.198.254.R099	1,98	25,4	6,2	0,99	5,95	3,95	2,95	28,0	1,8	6	32,00 €
	APG06.200.203.R100	2,0	20,3	6,2	1,0	5,95	3,95	2,95	23,0	1,8	6	35,00 €
	APG06.200.254.R100	2,0	25,4	6,2	1,0	5,95	3,95	2,95	28,0	1,8	6	36,00 €
	APG07.100.305.R050	1,0	30,5	7,2	0,5	6,95	4,25	3,45	33,0	2,5	7	42,00 €
	APG07.117.305.R0585	1,17	30,5	7,2	0,585	6,95	4,25	3,45	33,0	2,5	7	43,00 €
	APG07.150.305.R075	1,5	30,5	7,2	0,75	6,95	4,25	3,45	33,0	2,5	7	42,00 €
APG07.1574.305.R0787	1,574	30,5	7,2	0,787	6,95	4,25	3,45	33,0	2,5	7	43,00 €	
APG07.1626.305.R0813	1,626	30,5	7,2	0,813	6,95	4,25	3,45	33,0	2,5	7	43,00 €	
APG07.198.305.R099	1,98	30,5	7,2	0,99	6,95	4,25	3,45	33,0	2,5	7	43,00 €	
APG07.200.305.R100	2,0	30,5	7,2	1,0	6,95	4,25	3,45	33,0	2,5	7	41,00 €	

MINI CUT TOOLS / MINI CUT WERKZEUGE

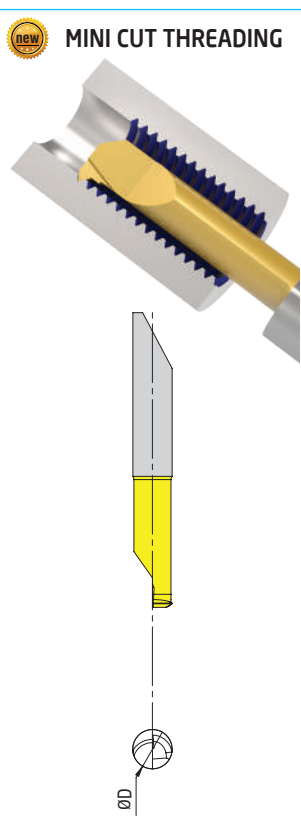
	CODE / TYP	TOOL DIMENSIONS (mm) MAB												PRICE / PREIS	
		PITCH Min.	PITCH Max.	L2	ØDmin	a	d	f	LH	S	t	w	ØD		
 <p>MINI CUT THREADING</p>	APT.04.152.050	0,5	0,7	15,2	4,2	3,95	2,95	1,95	18,0	0,35	0,4	0,06	4	28,00 €	
	APT.04.152.080	0,5	1,0	15,2	3,9	3,65	2,7	1,95	18,0	0,45	0,46	0,1	4	27,00 €	
	APT.05.152.050	0,5	0,75	15,2	5,2	4,95	3,75	2,45	18,0	0,35	0,43	0,06	5	27,00 €	
	APT.05.152.075	0,75	1,0	15,2	5,1	4,85	3,65	2,40	18,0	0,45	0,57	0,09	5	27,00 €	
	APT.05.152.100	1,0	1,25	15,2	4,8	4,55	3,55	2,25	18,0	0,55	0,7	0,12	5	27,00 €	
	APT.05.203.100	1,0	1,25	20,3	4,8	4,55	3,55	2,25	23,0	0,55	0,7	0,12	5	31,00 €	
	APT.05.254.100	1,0	1,25	25,4	4,8	4,55	3,55	2,25	28,0	0,55	0,7	0,12	5	36,00 €	
	APT.06.152.125	1,0	1,25	15,2	6,2	5,95	3,95	2,95	18,0	0,55	0,7	0,12	6	27,00 €	
	APT.06.152.150	1,25	1,5	15,2	6,2	5,95	3,95	2,95	18,0	0,75	0,84	0,16	6	28,00 €	
	APT.06.152.175	1,5	1,75	15,2	6,2	5,95	3,95	2,95	18,0	0,8	0,98	0,18	6	28,00 €	
	APT.06.203.125	1,25	1,5	20,3	6,2	5,95	3,95	2,95	23,0	0,75	0,84	0,16	6	32,00 €	
	APT.06.203.175	1,5	1,75	20,3	6,2	5,95	3,95	2,95	23,0	0,8	0,98	0,18	6	32,00 €	
	APT.06.254.125	1,25	1,5	25,4	6,2	5,95	3,95	2,95	28,0	0,75	0,84	0,16	6	36,00 €	
	APT.06.254.175	1,5	1,75	25,4	6,2	5,95	3,95	2,95	28,0	0,8	0,98	0,18	6	36,00 €	

MINI CUT TOOLS / MINI CUT WERKZEUGE

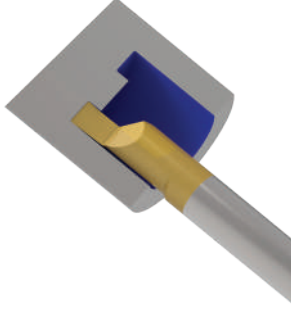

	CODE / TYP	TOOL DIMENSIONS (mm) MAB							PRICE / PREIS
		W	L2	R	f	LH	tmax	ØD	
 <p>MINI CUT FACE GROOVING</p>	APFG.06.150.1000	1,0	15,2	0,05	2,95	18,0	2,0	6	39,00 €
	APFG.06.150.1500	1,5	15,2	0,05	2,95	18,0	3,0	6	39,00 €
	APFG.06.150.0787	0,787	15,2	0,05	2,95	18,0	1,8	6	39,00 €
	APFG.06.152.1000	1,0	15,2	0,15	2,95	18,0	2,0	6	37,00 €
	APFG.06.152.1168	1,168	15,2	0,15	2,95	18,0	2,34	6	38,00 €
	APFG.06.152.1500	1,5	15,2	0,15	2,95	18,0	3,0	6	37,00 €
	APFG.06.152.1575	1,575	15,2	0,15	2,95	18,0	3,15	6	38,00 €
	APFG.06.152.1981	1,981	15,2	0,15	2,95	18,0	3,95	6	39,00 €
	APFG.06.152.2000	2,0	15,2	0,15	2,95	18,0	4,0	6	36,00 €
	APFG.06.152.2388	2,388	15,2	0,15	2,95	18,0	5,0	6	37,00 €
	APFG.06.152.2500	2,5	15,2	0,15	2,95	18,0	5,0	6	36,00 €
	APFG.06.152.3000	3,0	15,2	0,15	2,95	18,0	6,0	6	36,00 €
	APFG.06.152.3175	3,175	15,2	0,15	2,95	18,0	6,0	6	39,00 €



SPECIAL MINI CUT TOOLS

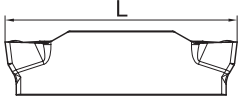

RING INSERTS / RINGEINSÄTZE

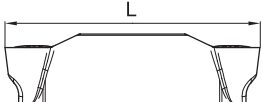
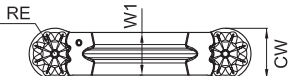
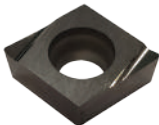
	CODE / TYP	INSERT DIMENSION (mm) MAB				PRICE / PREIS
		IC	W	R	T	
	ASK-125-13	13	1.25	0.2	1.3	35,00 €
	ASK-135-13	13	1.35	0.2	1.3	35,00 €
	ASK-145-13	13	1.45	0.2	1.3	35,00 €
	ASK-150-13	13	1.5	0.2	1.3	35,00 €
	ASK-165-18	13	1.65	0.2	1.8	35,00 €
	ASK-175-18	13	1.75	0.2	1.8	35,00 €
	ASK-185-23	13	1.85	0.2	2.3	35,00 €
	ASK-200-23	13	2	0.2	2.3	35,00 €
	ASK-220-33	13	2.2	0.2	3.3	35,00 €
	ASK-230-33	13	2.3	0.2	3.3	35,00 €
	ASK-250-33	13	2.5	0.3	3.3	35,00 €
	ASK-265-33	13	2.65	0.3	3.3	35,00 €
	ASK-270-33	13	2.7	0.3	3.3	35,00 €
	ASK-280-33	13	2.8	0.3	3.3	35,00 €
	ASK-300-33	13	3	0.3	3.3	35,00 €
	ASK-320-33	13	3.2	0.3	3.3	35,00 €
	ASK-330-33	13	3.3	0.3	3.3	35,00 €
	ASK-350-38	13	3.5	0.3	3.8	35,00 €
	ASK-370-38	13	3.7	0.3	3.8	35,00 €
	ASK-390-38	13	3.9	0.3	3.8	35,00 €
ASK-400-38	13	4	0.3	3.8	35,00 €	

GROOVING INSERT / STECHPLATTEN		PRICE / PREIS		
   	AGD2002-MT-AA4230 AGD2002-MT-AK1115 AGD2002-MT-AP1225 AGD2502-MT-AA4230 AGD2502-MT-AK1115 AGD2502-MT-AP1225 AGD3004-MT-AA4230 AGD3004-MT-AK1115 AGD3004-MT-AP1225 AGD4004-MT-AA4230 AGD4004-MT-AK1115 AGD4004-MT-AP1225 AGD5004-MT-AA4230 AGD5008-MT-AA4230 AGD5008-MT-AK1115 AGD5008-MT-AP1225 AGD6008-MT-AA4230 AGD6008-MT-AK1115 AGD8008-MT-AK1115	10,00 € 10,00 € 10,00 € 10,00 € 10,00 € 10,00 € 11,00 € 11,00 € 11,00 € 12,00 € 12,00 € 12,00 € 14,00 € 14,00 € 14,00 € 17,00 € 17,00 € 32,00 €		
	   	AGD2010-MR-AA4230 AGD2010-MR-AK1115 AGD2010-MR-AP1225 AGD3015-MR-AA4230 AGD3015-MR-AK1115 AGD3015-MR-AP1225 AGD4020-MR-AA4230 AGD4020-MR-AK1115 AGD4020-MR-AP1225 AGD5025-MR-AA4230 AGD5025-MR-AK1115 AGD5025-MR-AP1225 AGD6030-MR-AA4230 AGD6030-MR-AK1115 AGD6030-MR-AP1225 AGD8040-MR-AA4230	10,00 € 10,00 € 10,00 € 11,00 € 11,00 € 11,00 € 12,00 € 12,00 € 12,00 € 14,00 € 14,00 € 14,00 € 17,00 € 17,00 € 17,00 € 32,00 €	
		ADJUSTABLE BORING INSERTS / EINSTELLBARE WENDESCHNEIDPLATTEN FÜR SPINDELKÖPFE		PRICE / PREIS
			CCGT 09T302L-AC1020 CCGT 09T304L-AC1020	8,00 € 8,00 €
				TPGH 09T0202L-AC1020 TPGH 09T0204L-AC1020
				WCGT 020102L-AC1020 WCGT 020104L-AC1020

DRILLING INSERT / WENDESCHNEIDPLATTE FÜR BOHRER		PRICE / PREIS
	SPMX050204-VG3002	7,00 €
	SPMX060204-VG3002	7,00 €
	SPMX07T308-VG3002	7,00 €
	SPMX090408-VG3002	9,00 €
	SPMX110408-VG3002	9,00 €
	SPMX140512-VG3002	11,00 €
	WCMX030208-VG3002	6,00 €
	WCMX040208-VG3002	6,00 €
	WCMX050308-VG3002	6,00 €
	WCMX06T308-VG3002	7,00 €
	WCMX080412-VG3002	8,00 €

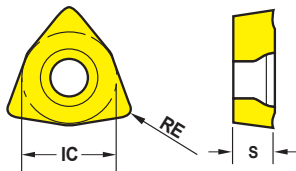
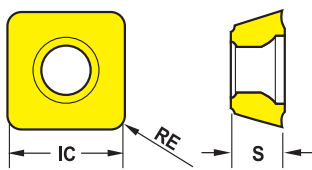

konusulan
the spoken kalite...
quality...

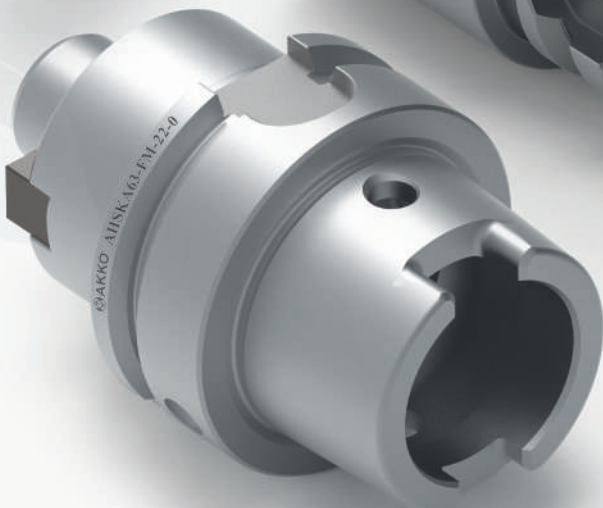
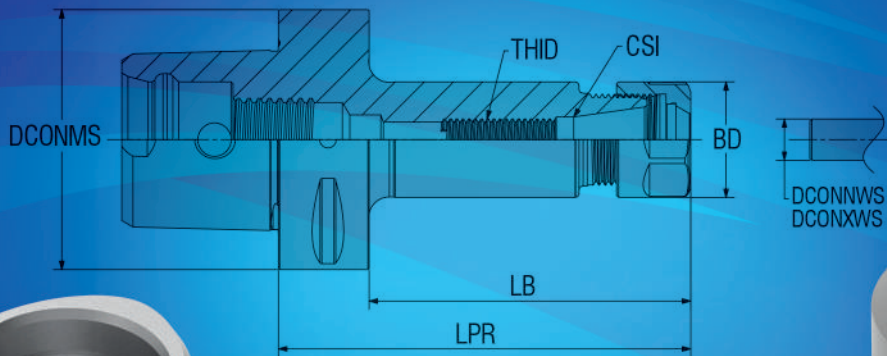

ISO 26623-1 / CAPTO END MILL HOLDER / CAPTO FRÄSERAUFNAHMEN

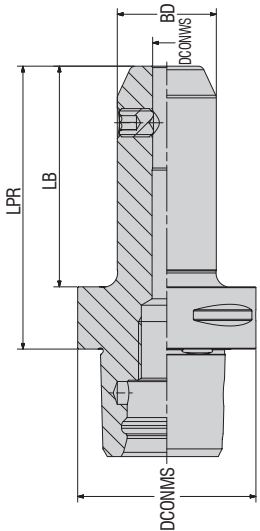
	CODE / TYP	TOOL DIMENSIONS (mm) MAB						PRICE / PREIS
		DCONMS	DCONWS	LPR	BD	LB	CRKS	
 	AC3-EM-06-045	32	06	45	25	30	M12	205,00 €
	AC3-EM-08-045	32	08	45	28	30	M12	205,00 €
	AC3-EM-10-050	32	10	50	34	35	M12	205,00 €
	AC3-EM-12-055	32	12	55	42	40	M12	205,00 €
	AC4-EM-06-050	40	06	50	25	30	M14	223,00 €
	AC4-EM-08-050	40	08	50	28	30	M14	223,00 €
	AC4-EM-10-050	40	10	50	35	30	M14	223,00 €
	AC4-EM-12-055	40	12	55	42	35	M14	223,00 €
	AC4-EM-14-055	40	14	55	44	35	M14	223,00 €
	AC4-EM-16-060	40	16	60	48	40	M14	223,00 €
	AC5-EM-06-050	50	06	50	25	30	M16	230,00 €
	AC5-EM-08-050	50	08	50	28	30	M16	230,00 €
	AC5-EM-10-055	50	10	55	35	35	M16	230,00 €
	AC5-EM-12-060	50	12	60	42	40	M16	230,00 €
	AC5-EM-14-060	50	14	60	44	40	M16	230,00 €
	AC5-EM-16-060	50	16	60	48	40	M16	230,00 €
	AC5-EM-18-060	50	18	60	50	40	M16	230,00 €
	AC5-EM-20-060	50	20	60	52	40	M16	230,00 €
	AC5-EM-25-080	50	25	80	65	60	M16	230,00 €
	AC6-EM-06-075	63	06	75	25	53	M20	250,00 €
	AC6-EM-06-100	63	06	100	25	78	M20	253,00 €
	AC6-EM-08-075	63	08	75	28	53	M20	250,00 €
	AC6-EM-08-100	63	08	100	28	78	M20	253,00 €
	AC6-EM-10-075	63	08	75	35	53	M20	250,00 €
	AC6-EM-10-100	63	10	100	35	78	M20	253,00 €
	AC6-EM-12-065	63	10	65	42	43	M20	246,00 €
	AC6-EM-12-080	63	10	80	42	58	M20	250,00 €
	AC6-EM-14-065	63	12	65	44	43	M20	246,00 €
	AC6-EM-14-100	63	12	100	44	78	M20	253,00 €
	AC6-EM-16-065	63	12	65	48	43	M20	246,00 €
	AC6-EM-16-085	63	14	85	48	63	M20	250,00 €
	AC6-EM-16-100	63	14	100	48	78	M20	253,00 €
	AC6-EM-18-065	63	16	65	50	43	M20	246,00 €
	AC6-EM-20-065	63	16	65	52	43	M20	246,00 €
	AC6-EM-20-100	63	20	100	52	78	M20	253,00 €
	AC6-EM-25-080	63	25	80	63	58	M20	246,00 €
	AC6-EM-32-090	63	32	90	72	68	M20	246,00 €
	AC6-EM-40-100	63	40	100	79	78	M20	246,00 €
	AC8-EM-06-070	80	06	70	25	40	M20	281,00 €
	AC8-EM-08-070	80	08	70	28	40	M20	281,00 €
AC8-EM-10-070	80	10	70	35	40	M20	281,00 €	
AC8-EM-12-070	80	12	70	42	40	M20	281,00 €	
AC8-EM-14-070	80	14	70	44	40	M20	281,00 €	
AC8-EM-16-070	80	16	70	48	40	M20	281,00 €	
AC8-EM-18-070	80	18	70	50	40	M20	281,00 €	
AC8-EM-20-070	80	20	70	52	40	M20	281,00 €	
AC8-EM-25-090	80	25	90	65	60	M20	288,00 €	
AC8-EM-32-100	80	32	100	72	70	M20	288,00 €	
AC8-EM-40-110	80	40	110	80	80	M20	288,00 €	
AC8-EM-50-120	80	50	120	100	90	M20	288,00 €	

ISO 26623-1 / CAPTO COLLET CHUCKS ER / CAPTO SPANNFUTTER ER

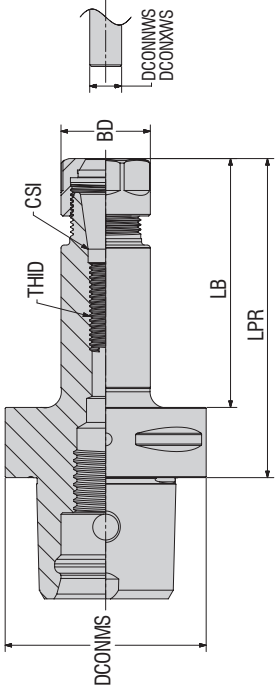
	CODE / TYP	TOOL DIMENSIONS (mm) <i>MAB</i>								PRICE / PREIS
		DCONMS	CSI	DCONWS	DCONXWS	BD	LPR	LB	THID	
 	AC3-ER-16-045	32	ER16	1.0	10	28	45	30	M10	185,00 €
	AC4-ER-16-070	40	ER16	1.0	10	28	70	50	M10	185,00 €
	AC4-ER-25-055	40	ER25	1.0	16	42	55	35	M16	185,00 €
	AC4-ER-32-055	40	ER32	2.0	20	50	55	35	M16	185,00 €
	AC4-ER-16-070-M	40	ER16	0.5	10	22	70	50	M10	202,00 €
	AC5-ER-16-055	50	ER16	1.0	10	28	55	35	M10	198,00 €
	AC5-ER-16-100	50	ER16	1.0	10	28	100	80	M10	232,00 €
	AC5-ER-16-130	50	ER16	1.0	10	28	130	110	M10	250,00 €
	AC5-ER-16-100-M	50	ER16	0.5	10	22	100	80	M10	253,00 €
	AC5-ER-16-130-M	50	ER16	0.5	10	22	130	110	M10	275,00 €
	AC5-ER-25-055	50	ER25	1.0	16	42	55	35	M16	198,00 €
	AC5-ER-25-100	50	ER25	1.0	16	42	100	80	M16	232,00 €
	AC5-ER-32-055	50	ER32	2.0	20	50	55	35	M16	198,00 €
	AC5-ER-32-100	50	ER32	2.0	20	50	100	80	M16	232,00 €
	AC6-ER-16-060	63	ER16	1.0	10	28	60	38	M10	198,00 €
	AC6-ER-16-100	63	ER16	1.0	10	28	100	78	M10	232,00 €
	AC6-ER-16-130	63	ER16	1.0	10	28	130	108	M10	250,00 €
	AC6-ER-16-100-M	63	ER16	0.5	10	22	100	78	M10	253,00 €
	AC6-ER-16-130-M	63	ER16	0.5	10	22	130	108	M10	271,00 €
	AC6-ER-25-060	63	ER25	1.0	16	42	60	38	M16	198,00 €
	AC6-ER-25-100	63	ER25	1.0	16	42	100	78	M16	232,00 €
	AC6-ER-25-130	63	ER25	1.0	16	42	130	108	M16	250,00 €
	AC6-ER-32-060	63	ER32	2.0	20	50	60	38	M16	198,00 €
	AC6-ER-32-100	63	ER32	2.0	20	50	100	78	M16	232,00 €
	AC6-ER-32-130	63	ER32	2.0	20	50	130	108	M16	250,00 €
	AC6-ER-40-065	63	ER40	3.0	26	63	65	43	M16	211,00 €
	AC6-ER-40-100	63	ER40	3.0	26	63	100	78	M16	246,00 €
	AC6-ER-40-130	63	ER40	3.0	26	63	130	108	M16	263,00 €
	AC8-ER-32-070	80	ER32	2.0	20	50	70	40	M16	260,00 €
	AC8-ER-32-100	80	ER32	2.0	20	50	100	70	M16	286,00 €
	AC8-ER-32-160	80	ER32	2.0	20	50	160	130	M16	327,00 €
	AC8-ER-40-070	80	ER40	3.0	26	63	70	40	M16	260,00 €
AC8-ER-40-100	80	ER40	3.0	26	63	100	70	M16	286,00 €	
AC8-ER-40-160	80	ER40	3.0	26	63	160	130	M16	327,00 €	

ISO 26623-1 / CAPTO SHELL MILL HOLDER / CAPTO AUFSTECKFRÄSERDORNE

	CODE / TYP	TOOL DIMENSIONS (mm) MAB							PRICE / PREIS
		DCONMS	DCONWS	BD	LSCWS	LB	LF	CRKS	
	AC3-FM-16-030	32	16	38	17	15	30	M12	215,00 €
	AC4-FM-16-035	40	16	38	17	15	35	M14	220,00 €
	AC4-FM-22-040	40	22	48	19	20	40	M14	220,00 €
	AC5-FM-16-035	50	16	38	17	15	35	M16	220,00 €
	AC5-FM-16-070	50	16	36	17	50	70	M16	233,00 €
	AC5-FM-22-040	50	22	48	19	20	40	M16	220,00 €
	AC5-FM-22-070	50	22	48	19	50	70	M16	233,00 €
	AC5-FM-27-040	50	27	60	21.5	20	40	M16	220,00 €
	AC6-FM-16-050	63	16	38	17	28	50	M20	226,00 €
	AC6-FM-16-100	63	16	38	17	78	100	M20	278,00 €
	AC6-FM-22-050	63	22	48	19	28	50	M20	226,00 €
	AC6-FM-22-100	63	22	48	19	78	100	M20	278,00 €
	AC6-FM-27-050	63	27	60	21.5	28	50	M20	226,00 €
	AC6-FM-27-100	63	27	60	21.5	78	100	M20	278,00 €
	AC6-FM-32-060	63	32	78	24	38	60	M20	226,00 €
	AC8-FM-27-100	80	27	60	21.5	70	100	M20	326,00 €
AC8-FM-32-100	80	32	78	24	70	100	M20	326,00 €	
AC8-FM-40-060	80	40	88	27	30	60	M20	285,00 €	

ISO 26623-1 / CAPTO TOOLHOLDER AXIAL / CAPTO WERKZEUGHALTER AXIAL

	CODE / TYP	TOOL DIMENSIONS (mm) MAB													PRICE / PREIS
		DCONMS	LPR	LSCWS	LF	WF	H	WSC	OAH	RADW	OAW	BD	ECA	HAND	
	AC4-ASHR-16-1	40	104	70	34	7	16	16	50	23	43.5	60	30	R	199,00 €
	AC5-ASHR-20-1	50	98	63.5	24.5	10	20	20	78	30	59	90	30	R	236,00 €
	AC6-ASHR-20-1	63	100	63.5	26.5	10	20	20	74	30	59	90	30	R	269,00 €
	AC6-ASHR-25-1	63	120	70	30	13	25	25	82	38	70	100	27	R	269,00 €
	AC8-ASHR-32-1	80	140	90	40	8	32	32	87	40	80	109	27	R	315,00 €

ISO 26623-1 / CAPTO EXTENSION / CAPTO SCHRUMPFVERLÄNGERUNGEN

	CODE / TYP	TOOL DIMENSIONS (mm) MAB				PRICE / PREIS
		DCONMS	DCONWS	LPR	CRKS	
	AC6-EX-C6-100	63	63	100	M20	312,00 €

ISO 12164-1 / HSK END MILL HOLDER / HSK FRÄSERAUFNAHMEN

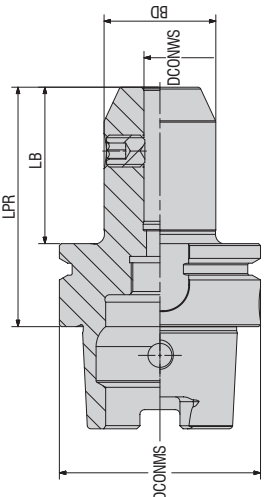
	CODE / TYP	TOOL DIMENSIONS (mm) MAB					PRICE / PREIS	
		DCONMS	DCONWS	LPR	BD	BD2		LB
 	AHSKA32-EM-06-060	32	06	60	25	-	40	129,00 €
	AHSKA32-EM-08-060	32	08	60	28	25	40	129,00 €
	AHSKA32-EM-10-065	32	10	65	34	25	45	129,00 €
	AHSKA32-EM-12-065	32	12	65	42	25	45	129,00 €
	AHSKA40-EM-06-060	40	06	60	25	-	40	115,00 €
	AHSKA40-EM-08-060	40	08	60	28	-	40	115,00 €
	AHSKA40-EM-10-060	40	10	60	35	32.6	40	115,00 €
	AHSKA40-EM-12-070	40	12	70	42	32.6	50	115,00 €
	AHSKA40-EM-16-075	40	16	75	48	32.6	55	115,00 €
	AHSKA50-EM-06-065	50	06	65	25	-	39	115,00 €
	AHSKA50-EM-08-065	50	08	65	28	-	39	115,00 €
	AHSKA50-EM-10-065	50	10	65	35	-	39	115,00 €
	AHSKA50-EM-12-080	50	12	80	42	41.6	54	115,00 €
	AHSKA50-EM-14-080	50	14	80	44	41.6	54	115,00 €
	AHSKA50-EM-16-080	50	16	80	48	41.6	54	115,00 €
	AHSKA50-EM-18-080	50	18	80	50	41.6	54	115,00 €
	AHSKA50-EM-20-080	50	20	80	52	41.6	54	115,00 €
	AHSKA63-EM-06-075	63	06	75	25	-	49	103,00 €
	AHSKA63-EM-06-100	63	06	100	25	-	74	121,00 €
	AHSKA63-EM-06-160	63	06	160	25	-	134	159,00 €
	AHSKA63-EM-08-075	63	08	75	28	-	49	96,00 €
	AHSKA63-EM-08-100	63	08	100	28	-	74	121,00 €
	AHSKA63-EM-08-160	63	08	160	28	-	134	159,00 €
	AHSKA63-EM-10-075	63	10	75	35	-	49	96,00 €
	AHSKA63-EM-10-100	63	10	100	35	-	74	121,00 €
	AHSKA63-EM-10-160	63	10	160	35	-	134	159,00 €
	AHSKA63-EM-12-080	63	12	80	42	-	54	96,00 €
	AHSKA63-EM-12-130	63	12	130	42	-	104	159,00 €
	AHSKA63-EM-14-080	63	14	80	44	-	54	96,00 €
	AHSKA63-EM-14-130	63	14	130	44	-	104	159,00 €
	AHSKA63-EM-16-080	63	16	80	48	-	54	96,00 €
	AHSKA63-EM-16-130	63	16	130	48	-	104	159,00 €
	AHSKA63-EM-18-080	63	18	80	50	-	54	96,00 €
	AHSKA63-EM-20-080	63	20	80	52	-	54	96,00 €
	AHSKA63-EM-20-130	63	20	130	52	-	104	159,00 €
	AHSKA63-EM-25-110	63	25	110	64	52.8	84	106,00 €
	AHSKA63-EM-32-110	63	32	110	72	52.8	84	115,00 €
	AHSKA80-EM-06-080	80	06	80	25	-	54	153,00 €
	AHSKA80-EM-08-080	80	08	80	28	-	54	153,00 €
	AHSKA80-EM-10-080	80	10	80	35	-	54	153,00 €
AHSKA80-EM-12-080	80	12	80	42	-	54	153,00 €	
AHSKA80-EM-14-080	80	14	80	44	-	54	153,00 €	
AHSKA80-EM-16-100	80	16	100	48	-	74	153,00 €	
AHSKA80-EM-18-100	80	18	100	50	-	74	153,00 €	
AHSKA80-EM-20-100	80	20	100	52	-	74	153,00 €	
AHSKA80-EM-25-100	80	25	100	65	-	74	171,00 €	
AHSKA80-EM-32-110	80	32	110	72	67.6	84	181,00 €	
AHSKA100-EM-06-080	100	06	80	25	-	51	138,00 €	
AHSKA100-EM-06-160	100	06	160	25	-	131	189,00 €	
AHSKA100-EM-08-080	100	08	80	28	-	51	136,00 €	
AHSKA100-EM-08-160	100	08	160	28	-	131	184,00 €	
AHSKA100-EM-10-080	100	10	80	35	-	51	136,00 €	
AHSKA100-EM-10-160	100	10	160	35	-	131	184,00 €	

ISO 12164-1 / HSK END MILL HOLDER / HSK FRÄSERAUFNAHMEN

	CODE / TYP	TOOL DIMENSIONS (mm) MAB						PRICE / PREIS
		DCONMS	DCONWS	LPR	BD	BD2	LB	
	AHska100-EM-12-080	100	12	80	42	-	51	136,00 €
	AHska100-EM-12-160	100	12	160	42	-	131	184,00 €
	AHska100-EM-14-080	100	14	80	44	-	51	136,00 €
	AHska100-EM-14-160	100	14	160	44	-	131	184,00 €
	AHska100-EM-16-100	100	16	100	48	-	71	136,00 €
	AHska100-EM-16-160	100	16	160	48	-	131	184,00 €
	AHska100-EM-18-100	100	18	100	50	-	71	136,00 €
	AHska100-EM-18-160	100	18	160	50	-	131	184,00 €
	AHska100-EM-20-100	100	20	100	52	-	71	136,00 €
	AHska100-EM-20-160	100	20	160	52	-	131	184,00 €
	AHska100-EM-25-100	100	25	100	65	-	71	139,00 €
	AHska100-EM-25-160	100	25	160	65	-	131	201,00 €
	AHska100-EM-32-100	100	32	100	72	-	71	151,00 €
	AHska100-EM-32-160	100	32	160	72	-	131	220,00 €
	AHska100-EM-40-100	100	40	100	80	-	71	165,00 €
	AHska100-EM-40-160	100	40	160	80	-	131	249,00 €

ISO 12164-1 / HSK COLLET CHUCKS ER / HSK SPANNFUTTER ER

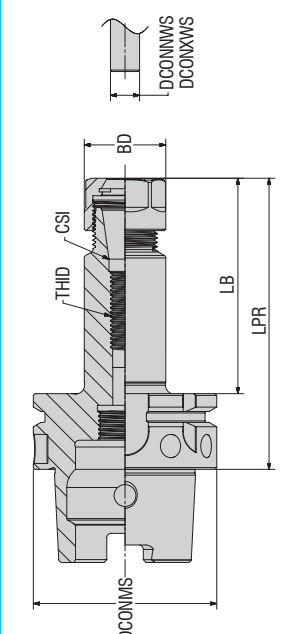
	CODE / TYP	TOOL DIMENSIONS (mm) MAB								PRICE / PREIS
		DCONMS	CSI	DCONWS	DCONXWS	BD	LPR	LB	THID	
 	AHska32-ER-16-080	32	ER16	32	10	28	80	48	M10	112,00 €
	AHska32-ER-25-080	32	ER25	32	16	42	80	48	M16	118,00 €
	AHska40-ER-16-060	40	ER16	40	10	28	60	40	M10	102,00 €
	AHska40-ER-16-100	40	ER16	40	10	28	100	80	M10	106,00 €
	AHska40-ER-25-060	40	ER25	40	16	42	60	40	M16	102,00 €
	AHska40-ER-25-100	40	ER25	40	16	42	100	80	M16	106,00 €
	AHska40-ER-32-100	40	ER32	40	20	50	100	80	M16	106,00 €
	AHska50-ER-16-100	50	ER16	50	10	28	100	74	M10	102,00 €
	AHska50-ER-16-100-M	50	ER16	0.5	10	22	100	74	M16	111,00 €
	AHska50-ER-25-100	50	ER25	1.0	16	42	100	74	M16	102,00 €
	AHska50-ER-32-100	50	ER32	2.0	20	50	100	74	M16	106,00 €
	AHska63-ER-16-080	63	ER16	0.5	10	28	80	54	M10	102,00 €
	AHska63-ER-16-100	63	ER16	0.5	10	28	100	74	M10	106,00 €
	AHska63-ER-16-160	63	ER16	0.5	10	28	160	134	M10	130,00 €
	AHska63-ER-16-100-M	63	ER16	0.5	10	22	100	71	M10	118,00 €
	AHska63-ER-16-160-M	63	ER16	0.5	10	22	100	71	M10	144,00 €
	AHska63-ER-25-100	63	ER25	1.0	16	42	100	74	M16	99,00 €
	AHska63-ER-25-160	63	ER25	1.0	16	42	160	134	M16	133,00 €
	AHska63-ER-32-075	63	ER32	2.0	20	50	75	49	M16	94,00 €
	AHska63-ER-32-100	63	ER32	2.0	20	50	100	74	M16	103,00 €
	AHska63-ER-32-160	63	ER32	2.0	20	50	160	134	M16	138,00 €
	AHska63-ER-40-080	63	ER40	3.0	26	63	80	54	M16	99,00 €
	AHska63-ER-40-100	63	ER40	3.0	26	63	100	74	M16	111,00 €
	AHska63-ER-40-160	63	ER40	3.0	26	63	160	134	M16	142,00 €
	AHska80-ER-32-100	80	ER32	2.0	20	50	100	74	M16	135,00 €
	AHska80-ER-40-120	80	ER40	3.0	26	63	120	94	M16	139,00 €
	AHska100-ER-16-100	100	ER16	0.5	10	28	100	71	M10	150,00 €
	AHska100-ER-16-160	100	ER16	0.5	10	28	160	131	M10	210,00 €
	AHska100-ER-25-100	100	ER25	1.0	16	42	100	71	M16	132,00 €
	AHska100-ER-25-160	100	ER25	1.0	16	42	160	131	M16	184,00 €
	AHska100-ER-32-100	100	ER32	2.0	20	50	100	71	M16	138,00 €
	AHska100-ER-32-160	100	ER32	2.0	20	50	160	131	M16	184,00 €
AHska100-ER-40-100	100	ER40	3.0	26	63	100	71	M16	144,00 €	
AHska100-ER-40-160	100	ER40	3.0	26	63	160	131	M16	195,00 €	

"M" Mini Type

Ordering Example / Beispiel Bestellformular: 1pcs. AHska100-EM-12-080

ISO 12164-1 / HSK SHELL MILL HOLDER / HSK AUFSTECKFRÄSERDORNE

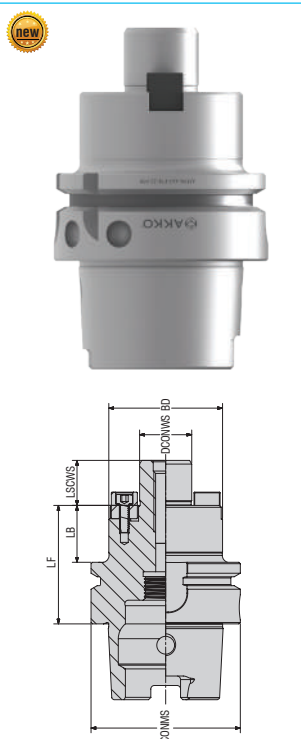
	CODE / TYP	TOOL DIMENSIONS (mm) MAB						PRICE / PREIS
		DCONMS	DCONWS	BD	LF	LSCWS	LB	
	AHKA50-FM-16-100	50	16	38	100	17	74	127,00 €
	AHKA50-FM-22-060	50	22	48	60	19	34	112,00 €
	AHKA50-FM-22-100	50	22	48	100	19	74	127,00 €
	AHKA50-FM-27-060	50	27	60	60	21.5	34	135,00 €
	AHKA50-FM-32-060	50	32	78	60	24	34	135,00 €
	AHKA63-FM-16-050	63	16	38	50	17	24	117,00 €
	AHKA63-FM-16-100	63	16	38	100	17	74	135,00 €
	AHKA63-FM-22-050	63	22	48	50	19	24	117,00 €
	AHKA63-FM-22-100	63	22	48	100	19	74	135,00 €
	AHKA63-FM-27-060	63	27	60	60	21.5	34	117,00 €
	AHKA63-FM-27-100	63	27	60	100	21.5	74	135,00 €
	AHKA63-FM-32-060	63	32	78	60	24	34	124,00 €
	AHKA63-FM-32-100	63	32	78	100	24	74	142,00 €
	AHKA80-FM-22-100	80	22	48	100	19	74	157,00 €
	AHKA80-FM-27-100	80	27	60	100	21.5	74	157,00 €
	AHKA80-FM-32-100	80	32	78	100	24	74	168,00 €
	AHKA80-FM-40-100	80	40	88	100	27	74	175,00 €
	AHKA100-FM-22-100	100	22	48	100	19	71	157,00 €
	AHKA100-FM-27-100	100	27	60	100	21.5	71	157,00 €
	AHKA100-FM-32-100	100	32	78	100	24	71	177,00 €
AHKA100-FM-40-100	100	40	88	100	27	71	177,00 €	

JIS B 6339 (MAS 403 BT) / BT END MILL HOLDER / BT FRÄSERAUFNAHMEN

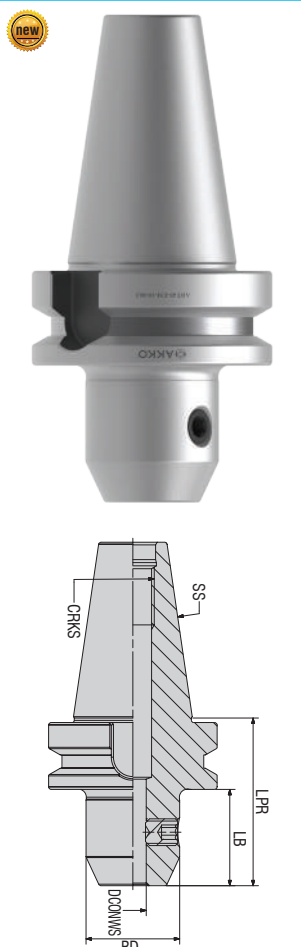
	CODE / TYP	TOOL DIMENSIONS (mm) MAB							PRICE / PREIS
		SS	DCONWS	LPR	BD	BD2	LB	CRKS	
	ABT30-EM-06-050	30	06	50	25	-	28	M12	53,00 €
	ABT30-EM-08-050	30	08	50	28	-	28	M12	52,00 €
	ABT30-EM-10-050	30	10	50	35	-	28	M12	52,00 €
	ABT30-EM-12-050	30	12	50	42	-	28	M12	52,00 €
	ABT30-EM-14-050	30	14	50	44	-	28	M12	52,00 €
	ABT30-EM-16-065	30	16	65	48	-	43	M12	52,00 €
	ABT30-EM-18-065	30	18	65	50	45	43	M12	52,00 €
	ABT40-EM-06-075	40	06	75	25	-	48	M16	48,00 €
	ABT40-EM-06-100	40	06	100	25	-	73	M16	63,00 €
	ABT40-EM-06-160	40	06	160	25	-	133	M16	87,00 €
	ABT40-EM-08-050	40	08	50	28	-	23	M16	47,00 €
	ABT40-EM-08-100	40	08	100	28	-	73	M16	61,00 €
	ABT40-EM-08-160	40	08	160	28	-	133	M16	86,00 €
	ABT40-EM-10-063	40	10	63	35	-	36	M16	47,00 €
	ABT40-EM-10-100	40	10	100	35	-	73	M16	61,00 €
	ABT40-EM-10-160	40	10	160	35	-	133	M16	86,00 €
	ABT40-EM-12-063	40	12	63	42	-	36	M16	47,00 €
	ABT40-EM-12-100	40	12	100	42	-	73	M16	61,00 €
	ABT40-EM-12-160	40	12	160	42	-	133	M16	86,00 €
	ABT40-EM-14-065	40	14	65	44	-	38	M16	47,00 €
	ABT40-EM-14-100	40	15	100	44	-	73	M16	61,00 €
	ABT40-EM-14-160	40	16	160	44	-	133	M16	86,00 €
	ABT40-EM-16-063	40	16	63	48	-	36	M16	47,00 €
	ABT40-EM-16-100	40	16	100	48	-	73	M16	61,00 €
	ABT40-EM-16-160	40	16	160	48	-	133	M16	86,00 €
	ABT40-EM-18-065	40	18	65	50	-	38	M16	47,00 €
	ABT40-EM-18-100	40	18	100	50	-	73	M16	61,00 €
	ABT40-EM-18-160	40	18	160	50	-	133	M16	86,00 €

JIS B 6339 (MAS 403 BT) / BT END MILL HOLDER / BT FRÄSERAUFNAHMEN

	CODE / TYP	TOOL DIMENSIONS (mm) MAB							PRICE / PREIS
		SS	DCONWS	LPR	BD	BD2	LB	CRKS	
	ABT40-EM-25-130	40	25	130	63	61	103	M16	79,00 €
	ABT40-EM-25-160	40	25	160	63	61	133	M16	95,00 €
	ABT40-EM-32-100	40	32	100	72	61	73	M16	65,00 €
	ABT40-EM-32-130	40	32	130	72	61	103	M16	82,00 €
	ABT40-EM-32-160	40	32	160	72	61	133	M16	102,00 €
	ABT50-EM-06-070	50	06	70	25	-	32	M24	73,00 €
	ABT50-EM-06-100	50	06	100	25	-	62	M24	87,00 €
	ABT50-EM-06-160	50	06	160	25	-	122	M24	112,00 €
	ABT50-EM-08-070	50	08	70	28	-	32	M24	66,00 €
	ABT50-EM-08-100	50	08	100	28	-	62	M24	79,00 €
	ABT50-EM-08-160	50	08	160	28	-	122	M24	112,00 €
	ABT50-EM-10-070	50	10	70	35	-	32	M24	66,00 €
	ABT50-EM-10-100	50	10	100	35	-	62	M24	79,00 €
	ABT50-EM-10-160	50	10	160	35	-	122	M24	112,00 €
	ABT50-EM-12-080	50	12	80	42	-	42	M24	66,00 €
	ABT50-EM-12-100	50	12	100	42	-	62	M24	79,00 €
	ABT50-EM-12-160	50	12	160	42	-	122	M24	112,00 €
	ABT50-EM-14-080	50	14	80	44	-	42	M24	66,00 €
	ABT50-EM-14-100	50	14	100	44	-	62	M24	79,00 €
	ABT50-EM-14-160	50	14	160	44	-	122	M24	112,00 €
	ABT50-EM-16-080	50	16	80	48	-	42	M24	66,00 €
	ABT50-EM-16-100	50	16	100	48	-	62	M24	79,00 €
	ABT50-EM-16-160	50	16	160	48	-	122	M24	112,00 €
	ABT50-EM-18-100	50	18	100	50	-	62	M24	79,00 €
	ABT50-EM-18-160	50	18	160	50	-	122	M24	112,00 €
	ABT50-EM-20-100	50	20	100	52	-	62	M24	66,00 €
	ABT50-EM-20-160	50	20	160	52	-	122	M24	112,00 €
	ABT50-EM-25-100	50	25	100	63	-	62	M24	73,00 €
ABT50-EM-25-160	50	25	160	63	-	122	M24	118,00 €	
ABT50-EM-32-110	50	32	110	72	-	72	M24	79,00 €	
ABT50-EM-32-160	50	32	160	72	-	122	M24	123,00 €	
ABT50-EM-40-110	50	40	110	80	-	72	M24	82,00 €	
ABT50-EM-40-160	50	40	160	80	-	122	M24	128,00 €	

JIS B 6339 (MAS 403 BT) / BT COLLET CHUCKS ER / BT SPANNFUTTER ER

	CODE / TYP	TOOL DIMENSIONS (mm) MAB									PRICE / PREIS
		SS	CSI	DCONWS	DCONXWS	BD	LPR	LB	THID	CRKS	
	ABT30-ER-16-060	30	ER16	0.5	10	28	60	33	M10	M12	68,00 €
	ABT30-ER-16-100	30	ER16	0.5	10	28	100	73	M10	M12	81,00 €
	ABT30-ER-25-060	30	ER25	1.0	16	42	60	33	M16	M12	69,00 €
	ABT30-ER-25-100	30	ER25	1.0	16	42	100	73	M16	M12	84,00 €
	ABT40-ER-16-063	40	ER16	0.5	10	28	63	36	M10	M16	63,00 €
	ABT40-ER-16-100	40	ER16	0.5	10	28	100	73	M10	M16	73,00 €
	ABT40-ER-16-130	40	ER16	0.5	10	28	130	103	M10	M16	82,00 €
	ABT40-ER-16-100-M	40	ER16	0.5	10	22	100	73	M10	M16	73,00 €
	ABT40-ER-16-130-M	40	ER16	0.5	10	22	130	103	M10	M16	82,00 €
	ABT40-ER-25-060	40	ER25	1.0	16	42	60	33	M16	M16	65,00 €
	ABT40-ER-25-100	40	ER25	1.0	16	42	100	73	M16	M16	74,00 €
	ABT40-ER-25-130	40	ER25	1.0	16	42	130	103	M16	M16	84,00 €
	ABT40-ER-32-070	40	ER32	2.0	20	50	70	43	M16	M16	66,00 €
	ABT40-ER-32-100	40	ER32	2.0	20	50	100	73	M16	M16	79,00 €
	ABT40-ER-32-160	40	ER32	2.0	20	50	160	133	M16	M16	97,00 €
	ABT40-ER-40-080	40	ER40	3.0	26	63	80	53	M16	M16	69,00 €

"M" Mini Type

Ordering Example / Beispiel Bestellformular: 1pcs. ABT40-EM-25-130

JIS B 6339 (MAS 403 BT) / BT COLLET CHUCKS ER / BT SPANNFUTTER ER

	CODE / TYP	TOOL DIMENSIONS (mm) MAB									PRICE / PREIS
		SS	CSI	DCONWS	DCONXWS	BD	LPR	LB	THID	CRKS	
	ABT40-ER-40-100	40	ER40	3.0	26	63	100	73	M16	M16	84,00 €
	ABT40-ER-40-160	40	ER40	3.0	26	63	160	133	M16	M16	108,00 €
	ABT50-ER-16-070	50	ER16	0.5	10	28	70	43	M10	M24	79,00 €
	ABT50-ER-16-100	50	ER16	0.5	10	28	100	73	M10	M24	97,00 €
	ABT50-ER-16-130	50	ER16	0.5	10	28	130	103	M10	M24	110,00 €
	ABT50-ER-16-100-M	50	ER16	0.5	10	22	100	62	M10	M24	97,00 €
	ABT50-ER-16-130-M	50	ER16	0.5	10	22	130	92	M10	M24	110,00 €
	ABT50-ER-16-160-M	50	ER16	0.5	10	22	160	122	M10	M24	125,00 €
	ABT50-ER-25-070	50	ER25	1.0	16	42	70	43	M16	M24	82,00 €
	ABT50-ER-25-100	50	ER25	1.0	16	42	100	73	M16	M24	99,00 €
	ABT50-ER-25-130	50	ER25	1.0	16	42	130	103	M16	M24	112,00 €
	ABT50-ER-32-070	50	ER32	2.0	20	50	70	43	M16	M24	84,00 €
	ABT50-ER-32-100	50	ER32	2.0	20	50	100	73	M16	M24	100,00 €
	ABT50-ER-32-130	50	ER32	2.0	20	50	130	103	M16	M24	115,00 €
	ABT50-ER-32-160	50	ER32	2.0	20	50	160	133	M16	M24	125,00 €
	ABT50-ER-40-080	50	ER40	3.0	26	63	80	53	M16	M24	87,00 €
	ABT50-ER-40-100	50	ER40	3.0	26	63	100	73	M16	M24	105,00 €
	ABT50-ER-40-160	50	ER40	3.0	26	63	160	133	M16	M24	136,00 €

JIS B 6339 (MAS 403 BT) / BT SHELL MILL HOLDER / BT QUERNUT-AUFSTECKDORN

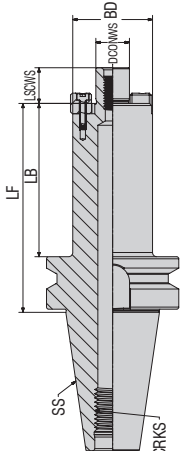
	CODE / TYP	TOOL DIMENSIONS (mm) MAB						PRICE / PREIS	
		SS	DCONWS	LF	BD	LSCWS	LB		CRKS
 	ABT30-FM-16-040	30	16	40	38	17	18	M12	63,00 €
	ABT30-FM-22-040	30	22	40	48	19	18	M12	63,00 €
	ABT30-FM-32-050	30	27	50	60	21.5	28	M12	66,00 €
	ABT30-FM-27-050	30	32	50	78	24	28	M12	63,00 €
	ABT40-FM-16-055	40	16	55	38	17	28	M16	56,00 €
	ABT40-FM-16-100	40	16	100	38	17	73	M16	82,00 €
	ABT40-FM-22-055	40	22	55	48	19	28	M16	56,00 €
	ABT40-FM-22-100	40	22	100	48	19	73	M16	82,00 €
	ABT40-FM-27-055	40	27	55	60	21.5	28	M16	56,00 €
	ABT40-FM-27-100	40	27	100	60	21.5	73	M16	82,00 €
	ABT40-FM-32-060	40	32	60	78	24	33	M16	61,00 €
	ABT40-FM-32-100	40	32	100	78	24	73	M16	86,00 €
	ABT40-FM-40-060	40	40	60	88	27	33	M16	69,00 €
	ABT50-FM-16-055	50	16	55	38	17	17	M24	82,00 €
	ABT50-FM-16-100	50	16	100	38	17	62	M24	102,00 €
	ABT50-FM-22-055	50	22	55	48	19	17	M24	82,00 €
	ABT50-FM-22-100	50	22	100	48	19	62	M24	102,00 €
	ABT50-FM-27-055	50	27	55	60	21.5	17	M24	82,00 €
	ABT50-FM-27-100	50	27	100	60	21.5	62	M24	102,00 €
	ABT50-FM-32-100	50	32	100	78	24	62	M24	110,00 €
ABT50-FM-40-100	50	40	100	88	27	62	M24	120,00 €	

DIN ISO 7388-1 (SK DIN 69871) / SK END MILL HOLDER / SK FRÄSERAUFNAHMEN









	CODE / TYP	TOOL DIMENSIONS (mm) MAB							PRICE / PREIS
		SS	DCONWS	LPR	BD	BD2	LB	CRKS	
	ASK40-EM-08-050	40	08	50	28	-	30,9	M16	47,00 €
	ASK40-EM-10-063	40	10	63	35	-	43,9	M16	47,00 €
	ASK40-EM-12-100	40	12	100	42	-	80,9	M16	61,00 €
	ASK40-EM-12-063	40	12	63	42	-	43,9	M16	47,00 €
	ASK40-EM-16-100	40	16	63	48	-	43,9	M16	61,00 €
	ASK40-EM-16-063	40	16	100	48	-	80,9	M16	47,00 €
	ASK40-EM-20-100	40	20	63	52	-	43,9	M16	61,00 €
	ASK40-EM-20-063	40	20	100	52	-	80,9	M16	47,00 €
	ASK40-EM-25-090	40	25	90	63	61	70,9	M16	61,00 €
	ASK40-EM-32-100	40	32	100	72	61	80,9	M16	65,00 €
	ASK40-EM-40-120	40	40	120	80	61	100,9	M16	69,00 €





DIN ISO 7388-1 (SK DIN 69871) / SK COLLET CHUCKS ER / SK SPANNFUTTER ER

	CODE / TYP	TOOL DIMENSIONS (mm) MAB									PRICE / PREIS
		SS	CSI	DCONWS	DCONXWS	BD	LPR	LB	THID	CRKS	
	ASK40-ER-16-063	40	ER16	0.5	10	28	63	43.9	M10	M16	63,00 €
	ASK40-ER-25-060	40	ER25	1.0	16	42	60	40.9	M16	M16	65,00 €
	ASK40-ER-25-100	40	ER25	1.0	16	42	100	80.9	M16	M16	74,00 €
	ASK40-ER-32-070	40	ER32	2.0	20	50	70	50.9	M16	M16	66,00 €
	ASK40-ER-32-100	40	ER32	2.0	20	50	100	80.9	M16	M16	79,00 €
	ASK40-ER-32-160	40	ER32	2.0	20	50	160	140.9	M16	M16	104,00 €
	ASK40-ER-40-080	40	ER40	3.0	26	63	80	60.9	M16	M16	69,00 €
	ASK40-ER-40-100	40	ER40	3.0	26	63	100	80.9	M16	M16	84,00 €
	ASK40-ER-40-160	40	ER40	3.0	26	63	160	140.9	M16	M16	108,00 €



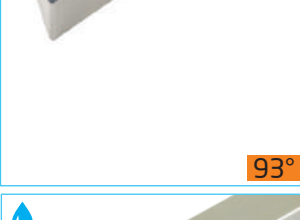



DIN ISO 7388-1 (SK DIN 69871) / SK SHELL MILL HOLDER / SK AUFSTECKFRÄSERDORNE

	CODE / TYP	TOOL DIMENSIONS (mm) MAB						PRICE / PREIS	
		SS	DCONWS	BD	LF	LSCWS	LB		CRKS
	ASK40-FM-16-055	40	16	38	55	17	35.9	M16	56,00 €
	ASK40-FM-16-100	40	16	38	100	17	80.9	M16	82,00 €
	ASK40-FM-22-055	40	22	48	55	19	35.9	M16	56,00 €
	ASK40-FM-27-055	40	27	60	55	21.5	35.9	M16	56,00 €
	ASK40-FM-32-060	40	32	78	60	24	40.9	M16	61,00 €
	ASK40-FM-40-060	40	40	88	60	27	40.9	M16	69,00 €





T - SYSTEM EXTERNAL TURNING TOOLHOLDERS / T-SYSTEM AUBEN - DREHHALTER			PRICE / PREIS
 75°	TCBNR / L CNM. 1606..	2525 M16	72,00 €
 75°	TCBNR/L CNM. 1204..	2020 K12-H 2525 M12-H 3232 P12-H	157,00 € 160,00 € 182,00 €
 75°	TCKNR / L CNM. 1204.. CNM. 1606..	2020 K12 2525 M12 2525 M16 3232 P12 3232 P16	69,00 € 70,00 € 72,00 € 79,00 € 83,00 €
 75°	TCKNR / L CNM. 1204..	2020 K12-H 2525 M12-H 3232 P12-H	157,00 € 160,00 € 182,00 €
 95°	TCLNR / L CNM. 1204.. CNM. 1606..	2020 K12 2525 M12 3232 P12 4040 S12 5050 S12 2525 M16 3232 P16	69,00 € 70,00 € 79,00 € 131,00 € 185,00 € 72,00 € 83,00 €
 95°	TCLNR / L CNM. 1204..	2020 K12-H 2525 M12-H 3232 P12-H	157,00 € 160,00 € 182,00 €
 50°	TCMNN CNM. 1204.. CNM. 1606..	1616 H12 2020 K12 2525 M12 3232 P12 2525 M16 3232 P16 4040 S16	67,00 € 69,00 € 70,00 € 79,00 € 72,00 € 83,00 € 135,00 €
 40°	TCZNN CNM. 1204.. CNM. 1606..	2020 K12 2525 M12 3232 P12 2525 M16 3232 P16	69,00 € 70,00 € 79,00 € 72,00 € 83,00 €

T - SYSTEM EXTERNAL TURNING TOOLHOLDERS / T-SYSTEM AUBEN - DREHHALTER			PRICE / PREIS
 <p>TDHNR / L DNM. 1104.. DNM. 1506..</p> <p>107.5°</p>	2525 M11	70,00 €	
	2020 K15	69,00 €	
	2525 M15	70,00 €	
	3232 P15	79,00 €	
 <p>TDJNR / L DNM. 1104.. DNM. 1504.. DNM. 1506..</p> <p>93°</p>	1616 H11	67,00 €	
	2020 K11	69,00 €	
	2525 M11	70,00 €	
	2020 K15	69,00 €	
	2525 M15	70,00 €	
	3232 P15	79,00 €	
	4040 S15	131,00 €	
	5050 S15	185,00 €	
	2020 K1504	69,00 €	
	2525 M1504	70,00 €	
3232 P1504	79,00 €		
4040 S1504	131,00 €		
 <p>TDJNR / L DNM. 1506..</p> <p>93°</p>	2020 K15-H	157,00 €	
	2525 M15-H	160,00 €	
	3232 P15-H	182,00 €	
 <p>TDNNN DNM. 1104.. DNM. 1506..</p> <p>62.5°</p>	1616 H11	67,00 €	
	2020 K11	69,00 €	
	2525 M11	70,00 €	
	2020 K15	69,00 €	
	2525 M15	70,00 €	
	3232 P15	79,00 €	
	4040 S15	131,00 €	
5050 S15	185,00 €		
 <p>TDNNN DNM. 1506..</p> <p>62.5°</p>	2525 M15-H	160,00 €	
	3232 P15-H	182,00 €	
 <p>TSDNN SNM. 1204.. SNM. 1506..</p> <p>45°</p>	1616 H12	67,00 €	
	2020 K12	69,00 €	
	2525 M12	70,00 €	
	3232 P12	79,00 €	
	2525 M15	72,00 €	
	3232 P15	83,00 €	
4040 S15	135,00 €		
 <p>TSDNN SNM. 1204.. SNM. 1506..</p> <p>45°</p>	2525 M12-H	160,00 €	
	3232 P12-H	182,00 €	
	2525 M15-H	160,00 €	
	3232 P15-H	182,00 €	
	4040 S15-H	293,00 €	

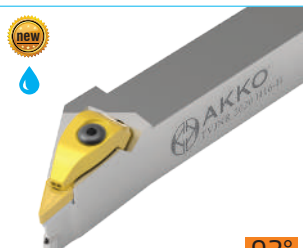

T - SYSTEM EXTERNAL TURNING TOOLHOLDERS / T-SYSTEM AUBEN - DREHHALTER **PRICE / PREIS**





 <p>75°</p>	TSKNR / L SNM. 1204.. SNM. 1506..	2020 K12	69,00 €
		2525 M12	70,00 €
		3232 P12	79,00 €
		3232 P15	83,00 €
 <p>45°</p>	TSSNR / L SNM. 1204.. SNM. 1506..	2020 K12	69,00 €
		2525 M12	70,00 €
		3232 P12	79,00 €
		2525 M15	72,00 €
		3232 P15	83,00 €
 <p>45°</p>	TSSNR / L SNM. 1204.. SNM. 1506..	2525 M12-H	160,00 €
		3232 P12-H	182,00 €
		2525 M15-H	160,00 €
		3232 P15-H	182,00 €
		4040 S15-H	293,00 €
 <p>60°</p>	TTENN TNM. 1604.. TNM. 2204..	2020 K16	69,00 €
		2525 M16	70,00 €
		3232 P16	79,00 €
		2525 M22	70,00 €
		3232 P22	79,00 €
		4040 S22	131,00 €
 <p>90°</p>	TTGNR / L TNM. 1604.. TNM. 2204..	2020 K16	69,00 €
		2525 M16	70,00 €
		3232 P16	79,00 €
		2525 M22	70,00 €
		3232 P22	79,00 €
		4040 S22	131,00 €
 <p>93°</p>	TTJNR / L TNM. 1604.. TNM. 2204..	2020 K16	69,00 €
		2525 M16	70,00 €
		3232 P16	79,00 €
		2525 M22	70,00 €
		3232 P22	79,00 €
		4040 S22	131,00 €
 <p>93°</p>	TTJNR / L TNM. 1604.. TNM. 2204..	2525 M16-H	160,00 €
		3232 P16-H	182,00 €
		2525 M22-H	160,00 €
		3232 P22-H	182,00 €

T - SYSTEM EXTERNAL TURNING TOOLHOLDERS / T-SYSTEM AUBEN - DREHHALTER **PRICE / PREIS**

 <p>107.5°</p>	TVHNR / L VNM. 1604..	2020 K16	69,00 €
		2525 M16	70,00 €
		3232 P16	79,00 €
 <p>93°</p>	TVJNR / L VNM. 1604..	2020 K16	69,00 €
		2525 M16	70,00 €
		3232 P16	79,00 €
 <p>93°</p>	TVJNR / L VNM. 1604..	2020 K16-H	157,00 €
		2525 M16-H	160,00 €
		3232 P16-H	182,00 €
 <p>72.5°</p>	TVVNN VNM. 1604..	2020 K16	69,00 €
		2525 M16	70,00 €
		3232 P16	79,00 €
 <p>72.5°</p>	TVVNN VNM. 1604..	2020 K16-H	157,00 €
		2525 M16-H	160,00 €
 <p>95°</p>	TWLNR / L WNM. 0604.. WNM. 0804..	1616 H06	67,00 €
		2020 K06	69,00 €
		2525 M06	70,00 €
		2020 K08	69,00 €
		2525 M08	70,00 €
		3232 P08	79,00 €
		4040 S08	131,00 €
		5050 S08	185,00 €
 <p>95°</p>	TWLNR / L WNM. 0804..	2020 K08-H	157,00 €
		2525 M08-H	160,00 €
		3232 P08-H	182,00 €







M - SYSTEM EXTERNAL TURNING TOOLHOLDERS / M -SYSTEM AUBEN - DREHHALTER			PRICE / PREIS
 <p>60°</p>	MTENN <hr/> TNM. 1604.. TNM. 2204..	2020 K16	69,00 €
		2525 M16	70,00 €
		3232 P16	79,00 €
		2525 M22	70,00 €
		3232 P22	79,00 €
		4040 S22	131,00 €
 <p>93°</p>	MTJNR / L <hr/> TNM. 1604.. TNM. 2204..	2020 K16	69,00 €
		2525 M16	70,00 €
		3232 P16	79,00 €
		2525 M22	70,00 €
		3232 P22	79,00 €
		4040 S22	131,00 €
 <p>95°</p>	MWLNR / L <hr/> WNM. 0604.. WNM. 0804..	1616 H06	67,00 €
		2020 K06	69,00 €
		2525 M06	70,00 €
		2020 K08	69,00 €
		2525 M08	70,00 €
		3232 P08	79,00 €
 <p>50°</p>	MWMNN <hr/> WNM. 0604.. WNM. 0804..	1616 H06	67,00 €
		2020 K06	69,00 €
		2525 M06	70,00 €
		2020 K08	69,00 €
		2525 M08	70,00 €
		3232 P08	79,00 €

P - SYSTEM EXTERNAL TURNING TOOLHOLDERS / P - SYSTEM AUBEN - DREHHALTER			PRICE / PREIS
 <p>PCBNR / L CNM. 1204.. CNM. 1606.. CNM. 1906.. CNM. 2509..</p> <p>75°</p>	2020 K12C	69,00 €	
	2525 M12C	70,00 €	
	3232 P12C	79,00 €	
	2525 M16C	72,00 €	
	3232 P16C	83,00 €	
	3232 P19C	104,00 €	
	4040 S19C	139,00 €	
	4040 S25C	152,00 €	
	5050 S25C	200,00 €	
 <p>PCLNR / L CNM. 0903.. CNM. 1204.. CNM. 1606.. CNM. 1906.. CNM. 2509..</p> <p>95°</p>	1616 H09	67,00 €	
	2020 K09	69,00 €	
	2525 M09	70,00 €	
	1616 H12	67,00 €	
	2020 K12C	69,00 €	
	2525 M12C	70,00 €	
	3232 P12C	79,00 €	
	2525 M16C	72,00 €	
	3232 P16C	83,00 €	
	2525 M19C	93,00 €	
	3232 P19C	104,00 €	
	4040 S19C	139,00 €	
	4040 S25C	152,00 €	
	5050 S25C	200,00 €	
 <p>PCLNR / L CNM. 1204.. CNM. 1606.. CNM. 1906..</p> <p>95°</p>	2020 K12-H	116,00 €	
	2525 M12-H	119,00 €	
	3232 P12-H	135,00 €	
	<small>NEW</small> 3232 P16-H	135,00 €	
	<small>NEW</small> 3232 P19-H	169,00 €	
 <p>PCMNN CNM. 1204.. CNM. 1906.. CNM. 2509..</p> <p>50°</p>	2020 K12C	69,00 €	
	2525 M12C	70,00 €	
	3232 P12C	79,00 €	
	2525 M16C	72,00 €	
	3232 P16C	83,00 €	
	3232 P19C	104,00 €	
	4040 S19C	139,00 €	
	5050 S19C	182,00 €	
	4040 S25C	152,00 €	
 <p>PDJNR / L DNM. 1104.. DNM. 1506..</p> <p>93°</p>	1616 H11	67,00 €	
	2020 K11	69,00 €	
	2525 M11	70,00 €	
	2020 K15C	69,00 €	
	2525 M15C	70,00 €	
	3232 P15C	79,00 €	
	4040 S15C	131,00 €	





P - SYSTEM EXTERNAL TURNING TOOLHOLDERS / P - SYSTEM AUBEN - DREHHALTER
PRICE / PREIS

 <p>93°</p>	PDJNR / L <hr/> DNM. 1506..	2020 K15-H	116,00 €
		2525 M15-H	119,00 €
		3232 P15-H	135,00 €
 <p>62.5°</p>	PDNNN <hr/> DNM. 1104.. DNM. 1506..	1616 H11	67,00 €
		2020 K11	69,00 €
		2525 M11	70,00 €
		2020 K15C	69,00 €
		2525 M15C	70,00 €
		3232 P15C	79,00 €
 <p>62.5°</p>	PDNNN <hr/> DNM. 1506..	2525 M15-H	119,00 €
 <p>75°</p>	PSBNR / L <hr/> SNM. 0903.. SNM. 1204.. SNM. 1506.. SNM. 1906.. SNM. 2509..	1616 H09	67,00 €
		2020 K09	69,00 €
		2020 K12	69,00 €
		2525 M12C	70,00 €
		3232 P12C	79,00 €
		2525 M15	72,00 €
		3232 P15C	83,00 €
		3232 P19C	104,00 €
		4040 S19C	139,00 €
		4040 S25C	152,00 €
		5050 S25C	200,00 €
 <p>45°</p>	PSDNN <hr/> SNM. 0903.. SNM. 1204.. SNM. 1506.. SNM. 1906.. SNM. 2509..	1616 H09	67,00 €
		2020 K12C	69,00 €
		2525 M12C	70,00 €
		3232 P12C	79,00 €
		2020 K15C	85,00 €
		2525 M15C	72,00 €
		3232 P19C	104,00 €
		4040 S19C	139,00 €
		5050 S19C	182,00 €
		4040 S25C	152,00 €
		5050 S25C	200,00 €



P - SYSTEM EXTERNAL TURNING TOOLHOLDERS / P - SYSTEM AUBEN - DREHHALTER **PRICE / PREIS**

 <p>75°</p>	PSKNR / L SNM. 0903.. SNM. 1204.. SNM. 1506.. SNM. 1906.. SNM. 2509..	2020 K09	69,00 €
		2020 K12C	69,00 €
		2525 M12C	70,00 €
		3232 P12C	79,00 €
		2525 M15C	72,00 €
		3232 P15C	83,00 €
		3232 P19C	104,00 €
		4040 S19C	139,00 €
		4040 S25C	152,00 €
		5050 S25C	200,00 €
 <p>45°</p>	PSSNR / L SNM. 0903.. SNM. 1204.. SNM. 1906.. SNM. 2509..	1616 H09	67,00 €
		2020 K09	69,00 €
		2020 K12C	69,00 €
		2525 M12C	70,00 €
		3232 P12C	79,00 €
		3232 P15C	83,00 €
		3232 P19C	104,00 €
		4040 S19C	139,00 €
		4040 S25C	152,00 €
		 <p>90°</p>	PTFNR / L TNM. 1604.. TNM. 2204..
2020 K16	69,00 €		
2525 M16	70,00 €		
3232 P16	79,00 €		
2525 M22C	70,00 €		
3232 P22C	79,00 €		
4040 S27	152,00 €		
 <p>90°</p>	PTGNR / L TNM. 1604.. TNM. 2204..		
		1212 F11	54,00 €
		1616 H11	62,00 €
		1616 H16	67,00 €
		2020 K16	69,00 €
		2525 M16	70,00 €
		3232 P16	79,00 €
		2525 M22C	70,00 €
		3232 P22C	79,00 €
		4040 S27	152,00 €
 <p>93°</p>	PTJNR / L TNM. 1604.. TNM. 2204..	1010 E11	54,00 €
		1212 F11	54,00 €
		1616 H11	62,00 €
		1616 H16	67,00 €
		2020 K16	69,00 €
		2525 M16	70,00 €
		3232 P16	79,00 €
		2525 M22C	70,00 €
		3232 P22C	79,00 €
		4040 S27C	152,00 €

P - SYSTEM EXTERNAL TURNING TOOLHOLDERS / P - SYSTEM AUBEN - DREHHALTER
PRICE / PREIS





 <p>60°</p>	PTTNR / L TNM. 1604.. TNM. 2204..	1616 H16	67,00 €
		2020 K16	69,00 €
		2525 M16	70,00 €
		3232 P16	79,00 €
		2525 M22C	70,00 €
		3232 P22C	79,00 €
 <p>95°</p>	PWLNR / L WNM. 0604.. WNM. 0804..	1616 H06	67,00 €
		2020 K06	69,00 €
		2525 M06	70,00 €
		3232 P06	79,00 €
		1616 H08	67,00 €
		2020 K08C	69,00 €
		2525 M08C	70,00 €
3232 P08C	79,00 €		
 <p>95°</p>	PWLNR / L WNM. 0804..	2020 K08-H	116,00 €
		2525 M08-H	119,00 €
 <p>93°</p>	PDJCR / L DC.T 11T3.	1010 K11-S	75,00 €
		1212 K11-S	79,00 €
		1616 K11-S	83,00 €
			



C - SYSTEM EXTERNAL TURNING TOOLHOLDERS / C - SYSTEM AUBEN - DREHHALTER
PRICE / PREIS

 <p>93°</p>	CKJNR / L KNUX 1604..	2020 K16	69,00 €
		2525 M16	70,00 €
		3232 P16	79,00 €
		4040 S16	152,00 €
 <p>95°</p>	CCLNR / L CN.N 1207.. CN.N 1607..	2525 M1207C	94,00 €
		3232 P1207C	106,00 €
		2525 M1607C	105,00 €

C - SYSTEM EXTERNAL TURNING TOOLHOLDERS / C - SYSTEM AUßEN - DREHHALTER **PRICE / PREIS**

 <p>CDJNR / L DN.N 1107.. DN.N 1507..</p> <p>93°</p>	2525 M1107C	94,00 €
	2525 M1507C	94,00 €
	3232 P1507C	106,00 €
 <p>CDNNN DN.N 1107..</p> <p>62.5°</p>	2525 M1107C	94,00 €
 <p>CRDCN RCGX 060600 RCGX 090700 RCGX 120700</p> <p>R</p>	2525 M06CV	138,00 €
	3225 P06CV	151,00 €
	4040 S06CV	192,00 €
	2525 M09CV	138,00 €
	3225 P09CV	151,00 €
	4040 S09CV	192,00 €
	2525 M12CV	138,00 €
	3225 P12CV	151,00 €
	4040 S12CV	192,00 €
 <p>CRDCN RCGX 060600 RCGX 090700 RCGX 120700</p> <p>new</p>	3232 P06CVK	270,00 €
	4040 R06CVK	344,00 €
	3232 P09CVK	270,00 €
	4040 R09CVK	344,00 €
	3232 P12CVK	270,00 €
	4040 R12CVK	344,00 €
 <p>CRDCR / L RCGX 060600 RCGX 090700 RCGX 120700</p>	3225 P06CV	151,00 €
	3225 P09CV	151,00 €
	3225 P12CV	151,00 €
 <p>CSDNN SN.N 1207..</p> <p>45°</p>	2525 M1207C	94,00 €
	3232 P1207C	106,00 €

C - SYSTEM EXTERNAL TURNING TOOLHOLDERS FOR CERAMIC INSERTS / C - SYSTEM AUßEN - DREHHALTER - FÜR KERAMIK WENDESCHNEIDPLATTEN			PRICE / PREIS
 <p>CSKNR / L SN.N 1207..</p> <p>75°</p>	2525 M1207C	94,00 €	
	3232 P1207C	106,00 €	
 <p>CSRNR / L SN.N 1207..</p> <p>45°</p>	2525 M1207C	94,00 €	
	3232 P1207C	106,00 €	
 <p>CSSNR / L SN.N 1207..</p> <p>45°</p>	2525 M1207C	94,00 €	
	3232 P1207C	106,00 €	
 <p>CTJNR / L TN.N 1607..</p> <p>93°</p>	2525 M1607C	94,00 €	
	3232 P1607C	106,00 €	

S - SYSTEM EXTERNAL TURNING TOOLHOLDERS / S - SYSTEM AUßEN - DREHHALTER			PRICE / PREIS
 <p>SCACR / L CC.T 0602.. CC.T 09T3.. CC.T 1204..</p> <p>90°</p>	0808 E06	42,00 €	
	1010 E06	42,00 €	
	1212 F09	42,00 €	
	1616 H09	47,00 €	
	2020 K09	49,00 €	
	2020 K12	49,00 €	
	2525 M12-Z	49,00 €	
	2525 M12	51,00 €	
	 <p>SCLCR / L CC.T 0602.. CC.T 09T3.. CC.T 1204..</p> <p>95°</p>	0808 E06	42,00 €
1010 E06		42,00 €	
1212 F06		42,00 €	
1010 E09		42,00 €	
1212 F09		42,00 €	
1616 H09		47,00 €	
2020 K09		49,00 €	
2525 M09		51,00 €	
1616 H12		47,00 €	
2020 K12-Z		47,00 €	
2020 K12		49,00 €	
2525 M12-Z		49,00 €	
2525 M12		51,00 €	



S - SYSTEM EXTERNAL TURNING TOOLHOLDERS / S - SYSTEM AUßEN - DREHHALTER		PRICE / PREIS
 <p>SCLCR / L CC.T 09T3..</p> <p>95°</p>	1212 K09-SHC	100,00 €
	1616 K09-SHC	115,00 €
 <p>SCMCN CC.T 0602.. CC.T 09T3.. CC.T 1204..</p> <p>50°</p>	0808 E06	42,00 €
	1010 E06	42,00 €
	1212 F06	42,00 €
	1212 F09	42,00 €
	1616 H09	47,00 €
	2020 K12	49,00 €
	2525 M12	51,00 €
 <p>SDHCR / L DC.T 0702.. DC.T 11T3..</p> <p>107.5°</p>	0808 E07	42,00 €
	1010 E07	42,00 €
	1212 F07	42,00 €
	1616 H07	42,00 €
	1616 H11	47,00 €
	2020 K11	49,00 €
	2525 M11	51,00 €
	3232 P11	58,00 €
 <p>SDJCR / L DC.T 0702.. DC.T 11T3..</p> <p>93°</p>	0808 E07	42,00 €
	1010 E07	42,00 €
	1212 F07	42,00 €
	1616 H07	42,00 €
	1212 F11	42,00 €
	1616 H11	47,00 €
	2020 K11	49,00 €
	2525 M11	51,00 €
3232 P11	58,00 €	
 <p>SDJCR / L DC.T 0702.. DC.T 11T3..</p> <p>93°</p>	0810 G07-SHC	107,00 €
	1010 K07-SHC	107,00 €
	1012 K11-SHC	107,00 €
	1212 K11-SHC	107,00 €
	1616 K11-SHC	123,00 €
 <p>SDNCN DC.T 0702.. DC.T 11T3..</p> <p>62.5°</p>	0808 E07	42,00 €
	1010 E07	42,00 €
	1212 F07	42,00 €
	1616 H07	42,00 €
	1616 H11	47,00 €
	2020 K11	49,00 €
	2525 M11	51,00 €
3232 P11	58,00 €	

S - SYSTEM EXTERNAL TURNING TOOLHOLDERS / S - SYSTEM AUßEN - DREHHALTER		PRICE / PREIS
 <p>SRDCN</p> <p>RC.T 0602.. RC.T 0803.. RC.T 10T3.. RC.T 1204.. RC.T 1605.. RC.T 2006.. RC.T 2507.. RC.T 3209..</p> <p>R</p>	1616 H06	47,00 €
	2020 K06	49,00 €
	2525 M06	51,00 €
	1616 H08C	47,00 €
	2020 K08C	49,00 €
	2525 M08C	51,00 €
	1616 H10C	47,00 €
	2020 K10C	49,00 €
	2525 M10C	51,00 €
	3232 P10C	58,00 €
	2020 K12C	49,00 €
	2525 M12C	51,00 €
	3232 P12C	58,00 €
	2525 M16C	54,00 €
	3232 P16C	62,00 €
	2525 M20C	106,00 €
3232 P20C	125,00 €	
3232 P25C	125,00 €	
3232 P32C	125,00 €	
 <p>SRDCR / L</p> <p>RC.T 1204..</p> <p>R</p>	3232 T06	102,00 €
	3232 P12C	58,00 €
 <p>SRGCR / L</p> <p>RC.T 0602.. RC.T 0803.. RC.T 10T3.. RC.T 1204..</p> <p>R</p>	1616 H06	47,00 €
	2020 K06	49,00 €
	1616 H08C	47,00 €
	2020 K08C	49,00 €
	2525 M08C	51,00 €
	1616 H10C	47,00 €
	2020 K10C	49,00 €
	2525 M10C	51,00 €
	3232 P10C	58,00 €
	2020 K12C	49,00 €
2525 M12C	51,00 €	
3232 P12C	58,00 €	
 <p>SRHCR / L</p> <p>RC.T 0602.. RC.T 0803.. RC.T 10T3.. RC.T 1204.. RC.T 1606..</p> <p>R</p>	2525 K06	131,00 €
	2525 K08	131,00 €
	2525 K10	131,00 €
	2525 K12	131,00 €
	2525 K16	131,00 €



S - SYSTEM EXTERNAL TURNING TOOLHOLDERS / S - SYSTEM AUßEN - DREHHALTER			PRICE / PREIS
 <p>SRXCR / L RC.T 0803.. RC.T 10T3.. RC.T 1204..</p> <p>R</p>	3232 X08C	128,00 €	
	3232 X10C	128,00 €	
	3232 X12C	128,00 €	
 <p>SSDCN SC.T 09T3.. SC.T 1204.. SC.T 1605..</p> <p>45°</p>	1212 F09	42,00 €	
	1616 H09-Z	42,00 €	
	1616 H09	47,00 €	
	2020 K09-Z	47,00 €	
	2020 K09	49,00 €	
	1616 H12-Z	42,00 €	
	1616 H12	47,00 €	
	2020 K12	49,00 €	
	2525 M12	51,00 €	
 <p>SSSCR / L SC.T 09T3.. SC.T 1204..</p> <p>45°</p>	1212 F09	42,00 €	
	1616 H09-Z	42,00 €	
	1616 H09	47,00 €	
	2020 K09-Z	47,00 €	
	2020 K09	49,00 €	
	1616 H12	47,00 €	
	2020 K12-Z	47,00 €	
	2020 K12	49,00 €	
	2525 M12-Z	49,00 €	
	2525 M12	51,00 €	
 <p>STFRCR / L TC.T 0902.. TC.T 1102.. TC.T 16T3..</p> <p>90°</p>	0808 E09	42,00 €	
	1010 E09	42,00 €	
	1212 F11	42,00 €	
	1616 H11	42,00 €	
	1616 H16	47,00 €	
	2020 K16	49,00 €	
	2525 M16	51,00 €	
	3232 P16	58,00 €	
 <p>STGCR / L TC.T 0902.. TC.T 1102.. TC.T 16T3..</p> <p>90°</p>	0808 E09	42,00 €	
	1010 E09	42,00 €	
	1212 F11	42,00 €	
	1616 H11	42,00 €	
	1616 H16	47,00 €	
	2020 K16	49,00 €	
	2525 M16	51,00 €	
	3232 P16	58,00 €	

S - SYSTEM EXTERNAL TURNING TOOLHOLDERS / S - SYSTEM AUßEN - DREHHALTER			PRICE / PREIS
 <p>93°</p>	STJCR / L TC.T 0902.. TC.T 1102.. TC.T 16T3..	0808 E09	42,00 €
		1010 E09	42,00 €
		1212 F11	42,00 €
		1616 H11	42,00 €
		1616 H16	47,00 €
		2020 K16	49,00 €
		2525 M16	51,00 €
		3232 P16	58,00 €
 <p>90°</p>	STCCN TC.T 1102.. TC.T 16T3.. TC.T 2204..	2020 L11	78,00 €
		1616 K16	72,00 €
		2020 M16	78,00 €
		2525 P16	84,00 €
		3232 R16	94,00 €
		2525 P22	84,00 €
 <p>93°</p>	STUCR / L TC.T 0902.. TC.T 1102.. TC.T 16T3..	0808 E09	42,00 €
		1010 E09	42,00 €
		1212 F11	42,00 €
		1616 H11	42,00 €
		1616 H16	47,00 €
		2020 K16	49,00 €
		2525 M16	51,00 €
		3232 P16	58,00 €
 <p>107.5°</p>	SVHBR / L VBM. 1103.. VBM. 1604..	1212 F11	42,00 €
		1616 H11	42,00 €
		2020 K11	47,00 €
		2020 K16	49,00 €
		2525 M16	51,00 €
		3232 P16	58,00 €
 <p>107.5°</p>	SVHCR / L VC.T 1103.. VC.T 1604..	1212 F11	42,00 €
		1616 H11	42,00 €
		2020 K11	47,00 €
		2020 K16	49,00 €
		2525 M16	51,00 €
		3232 P16	58,00 €
 <p>93°</p>	SVJBR / L VBM. 1103.. VBM. 1604..	1212 F11	42,00 €
		1616 H11	42,00 €
		2020 K11	47,00 €
		1616 H16	47,00 €
		2020 K16	49,00 €
		2525 M16	51,00 €
		3232 P16	58,00 €
		 <p>93°</p>	SVJCR / L VC.T 1103.. VC.T 1604..
1616 H11	42,00 €		
2020 K11	47,00 €		
2525 M11	49,00 €		
1212 F16	42,00 €		
2020 K16	49,00 €		
2525 M16	51,00 €		
3232 P16	58,00 €		

S - SYSTEM EXTERNAL TURNING TOOLHOLDERS / S - SYSTEM AUßEN - DREHHALTER PRICE / PREIS

 <p>SVJCR / L VC.T 1103..</p> <p>93°</p>	1212 K11-SHC	107,00 €
	1616 K11-SHC	123,00 €
 <p>SVVBN VBM. 1103.. VBM. 1604..</p> <p>72.5°</p>	1212 F11	42,00 €
	1616 H11	42,00 €
	2020 K11	47,00 €
	2020 K16	49,00 €
	2525 M16	51,00 €
	3232 P16	58,00 €
 <p>SVVCN VC.T 1103.. VC.T 1604..</p> <p>72.5°</p>	1212 F11	42,00 €
	1616 H11	42,00 €
	2020 K11	47,00 €
	2020 K16	49,00 €
	2525 M16	51,00 €
	3232 P16	58,00 €

TOOLS FOR SWISS TYPE SLIDING AUTOMATIC LATHES / WERKZEUGE FÜR LANGDREHAUTOMATEN PRICE / PREIS

 <p>SCACR / L CC.T 0602.. CC.T 09T3..</p> <p>90°</p>	0808 X06-S	51,00 €
	1010 K06-S	53,00 €
	1212 G06-S	53,00 €
	1212 K06-S	56,00 €
	1616 F06-S	56,00 €
	1616 K06-S	58,00 €
	1212 G09-S	53,00 €
	1212 K09-S	56,00 €
	1616 F09-S	56,00 €
	1616 K09-S	58,00 €
	2020 K09-S	61,00 €
 <p>SCLCR / L CC.T 0602.. CC.T 09T3..</p> <p>95°</p>	0808 X06-S	51,00 €
	1010 X06-S	51,00 €
	1212 G06-S	53,00 €
	1212 X06-S	53,00 €
	1212 K06-S	56,00 €
	1616 F06-S	56,00 €
	1616 X06-S	56,00 €
	1212 G09-S	53,00 €
	1212 X09-S	53,00 €
	1616 F09-S	56,00 €
	1616 G09-S	56,00 €
1616 X09-S	56,00 €	
2020 X09-S	58,00 €	

TOOLS FOR SWISS TYPE SLIDING AUTOMATIC LATHES / WERKZEUGE FÜR LANGDREHAUTOMATEN		PRICE / PREIS
 <p>SDACR / L DC.T 0702.. DC.T 11T3..</p> <p>90°</p>	0808 X07-S	51,00 €
	1010 K07-S	53,00 €
	1212 G07-S	53,00 €
	1212 K07-S	56,00 €
	1616 F07-S	56,00 €
	1616 K07-S	58,00 €
	1212 G11-S	53,00 €
	1212 K11-S	56,00 €
	1616 F11-S	56,00 €
	1616 K11-S	58,00 €
	2020 K11-S	61,00 €
 <p>SDJCR / L DC.T 0702.. DC.T 11T3..</p> <p>93°</p>	0808 X07-S	51,00 €
	1010 X07-S	51,00 €
	1212 G07-S	53,00 €
	1212 X07-S	53,00 €
	1616 F07-S	56,00 €
	1616 X07-S	56,00 €
	2020 X07-S	58,00 €
	1212 G11-S	53,00 €
	1212 X11-S	53,00 €
	1212 K11-S	56,00 €
	1616 F11-S	56,00 €
1616 X11-S	56,00 €	
1616 K11-S	58,00 €	
2020 X11-S	58,00 €	
 <p>STGCR / L TC.T 1102.. TC.T 16T3..</p> <p>91°</p>	1216 K11-S	58,00 €
	1616 K11-S	58,00 €
	1216 K16-S	58,00 €
	1616 K16-S	58,00 €
 <p>STGCR / L TC.T 16T3..</p> <p>90°</p>	1216 K16-SHC	123,00 €
	1616 K16-SHC	123,00 €
 <p>SVJBR / L VBM. 1103..</p> <p>93°</p>	1616 K11-S	58,00 €

TOOLS FOR SWISS TYPE SLIDING AUTOMATIC LATHES / WERKZEUGE FÜR LANGDREHAUTOMATEN **PRICE / PREIS**

 <p>SVACR / L VC.T 1103.. VC.T 1604..</p> <p>90°</p>	0808 X11-S	51.00 €
	1010 K11-S	53.00 €
	1212 G11-S	53.00 €
	1212 K11-S	56.00 €
	1616 F11-S	56.00 €
	1616 K11-S	58.00 €
	2020 K11-S	61.00 €
	1212 K16-S	56.00 €
	1616 K16-S	58.00 €

 <p>SVJCR / L VC.T 1103..</p> <p>93°</p>	0808 X11-S	51,00 €
	1010 K11-S	53,00 €
	1212 G11-S	53,00 €
	1212 K11-S	56,00 €
	1616 F11-S	56,00 €
	1616 K11-S	58,00 €
	2020 K11-S	61.00 €

SEC TOOLS **PRICE / PREIS**

	ASTB-1212-L84-H	153,00 €
	ASTB-1616-L90-H	165,00 €



 <p>SDJCR / L DC.T 070202 DC.T 11T302</p> <p>93°</p>	12X43.3-07	129,00 €
	12X43.3-07-H	165,00 €
	16X43.3-07	129,00 €
	16X43.3-07-H	165,00 €
	12X43.3-11	129,00 €
	12X43.3-11-H	165,00 €
	16X43.3-11	129,00 €
	16X43.3-11-H	165,00 €



 <p>SVJCR / L VC.T 110302</p> <p>93°</p>	12X43.3-11	129,00 €
	12X43.3-11-H	165,00 €
	16X43.3-11	129,00 €
	16X43.3-11-H	165,00 €

 <p>SER / L TER / L 11 ER/EL 16 ER/EL</p> <p>93°</p>	SER/L-12x43.3-11	129,00 €
	SER/L-16x43.3-11	129,00 €
	TER/L-16x43.3-16	175,00 €

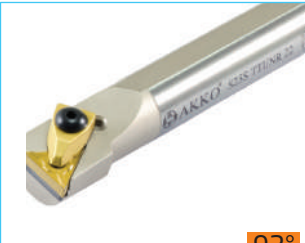



T - SYSTEM BORING BARS / T-SYSTEM BOHRSTANGE			PRICE / PREIS
 <p>95°</p>	TCLNR / L CNM. 0903.. CNM. 1204.. CNM. 1606..	S25S TCLNR / L 09-Z	78,00 €
		S25S TCLNR / L 09	81,00 €
		S25S TCLNR / L 12-Z	78,00 €
		S25S TCLNR / L 12	81,00 €
		S32T TCLNR / L 12	100,00 €
		S40U TCLNR / L 12	131,00 €
		S50V TCLNR / L 12	158,00 €
		S32T TCLNR / L 16	104,00 €
		S40U TCLNR / L 16	139,00 €
		S50V TCLNR / L 16	167,00 €
		<small>NEW</small> A25R TCLNR / L 12	100,00 €
		<small>NEW</small> A40T TCLNR / L 12	167,00 €
		<small>NEW</small> A50V TCLNR / L 12	216,00 €
 <p>62.5°</p>	TD-NR / L DNM. 1506..	S32T TD-NR / L 15	100,00 €
		S40U TD-NR / L 15	131,00 €
		S50V TD-NR / L 15	158,00 €
 <p>107.5°</p>	TDQNR / L DNM. 1104.. DNM. 1506..	S25S TDQNR / L 11-Z	78,00 €
		S25S TDQNR / L 11	81,00 €
		S32T TDQNR / L 11	100,00 €
		S25S TDQNR / L 15	81,00 €
		S32T TDQNR / L 15	100,00 €
		S40U TDQNR / L 15	131,00 €
		S50V TDQNR / L 15	158,00 €
 <p>93°</p>	TDUNR / L DNM. 1104.. DNM. 1506..	S25S TDUNR / L 11-Z	78,00 €
		S25S TDUNR / L 11	81,00 €
		S32T TDUNR / L 11	100,00 €
		S25S TDUNR / L 15	81,00 €
		S32T TDUNR / L 15	100,00 €
		S40U TDUNR / L 15	131,00 €
		S50V TDUNR / L 15	158,00 €
		<small>NEW</small> A40T TDUNR / L 15	167,00 €
 <p>75°</p>	TSKNR / L SNM. 1204..	S25S TSKNR / L 12-Z	78,00 €
		S25S TSKNR / L 12	81,00 €
		S32T TSKNR / L 12	100,00 €
		S40U TSKNR / L 12	131,00 €

T - SYSTEM BORING BARS / T-SYSTEM BOHRSTANGE			PRICE / PREIS
 <p>TT-NR / L TNM. 1604.. 60°</p>	S25S TT-NR / L 16	81,00 €	
	S32T TT-NR / L 16	100,00 €	
 <p>TTUNR / L TNM. 1604.. TNM. 2204.. 93°</p>	S25S TTUNR / L 16	81,00 €	
	S25S TTUNR / L 16	81,00 €	
	S32T TTUNR / L 16	100,00 €	
	S25S TTUNR / L 22	81,00 €	
	S32T TTUNR / L 22	100,00 €	
	S40U TTUNR / L 22	131,00 €	
	S50V TTUNR / L 22	158,00 €	
 <p>TVUNR / L VNM. 1604.. 93°</p>	S25S TVUNR / L 16	81,00 €	
	S32T TVUNR / L 16	100,00 €	
	S40U TVUNR / L 16	131,00 €	
 <p>TWLNR / L WNM. 0604.. WNM. 0804.. 95°</p>	S25S TWLNR / L 06-Z	78,00 €	
	S25S TWLNR / L 06	81,00 €	
	S32T TWLNR / L 06	100,00 €	
	S25S TWLNR / L 08-Z	78,00 €	
	S25S TWLNR / L 08	81,00 €	
	S32T TWLNR / L 08	100,00 €	
	S40U TWLNR / L 08	131,00 €	
	S50V TWLNR / L 08	158,00 €	
	A40T TWLNR / L 08	158,00 €	
A50U TWLNR / L 08	192,00 €		

C - SYSTEM BORING BARS / BOHRSTANGE C-SYSTEM			PRICE / PREIS
 <p>CKUNR / L KNUX 1604.. 93°</p>	S25S CKUNR / L 16	81,00 €	
	S32T CKUNR / L 16	100,00 €	
	S40U CKUNR / L 16	131,00 €	
	S50V CKUNR / L 16	158,00 €	
 <p>CTFPR / L TP.. 1603.. new</p>	S16R CTFPR / L 16	71,00 €	
	S20S CTFPR / L 16	76,00 €	
	S25T CTFPR / L 16	81,00 €	





M - SYSTEM BORING BARS / BOHRSTANGE M-SYSTEM			PRICE / PREIS
 <p>MCLNR / L CNM. 1204..</p> <p>95°</p>	S20R MCLNR / L 12	70,00 €	
	S25S MCLNR / L 12-Z	78,00 €	
	S25S MCLNR / L 12	81,00 €	
	S32T MCLNR / L 12	100,00 €	
 <p>MDUNR / L DNM. 1104.. DNM. 1506..</p> <p>93°</p>	S20R MDUNR / L 11	70,00 €	
	S25S MDUNR / L 11	78,00 €	
	S32T MDUNR / L 11	100,00 €	
	S25S MDUNR / L 15-Z	78,00 €	
	S25S MDUNR / L 15	81,00 €	
	S32T MDUNR / L 15	100,00 €	
	S40U MDUNR / L 15	131,00 €	
	S50V MDUNR / L 15	158,00 €	
 <p>MTFNR / L TNM. 1604.. TNM. 2204..</p> <p>90°</p>	S20R MTFNR / L 16	70,00 €	
	S25S MTFNR / L 16	81,00 €	
	S32T MTFNR / L 16	100,00 €	
	S40U MTFNR / L 16	131,00 €	
	S32T MTFNR / L 22	100,00 €	
	S40U MTFNR / L 22	131,00 €	
	S50V MTFNR / L 22	158,00 €	
 <p>MT-NR / L TNM. 1604.. TNM. 2204..</p> <p>60°</p>	S20R MT-NR / L 16	70,00 €	
	S25S MT-NR / L 16-Z	78,00 €	
	S25S MT-NR / L 16	81,00 €	
	S32T MT-NR / L 16	100,00 €	
	S40U MT-NR / L 16	131,00 €	
	S32T MT-NR / L 22	100,00 €	
	S40U MT-NR / L 22	131,00 €	
	S50U MT-NR / L 22	158,00 €	
 <p>MTQNR / L TNM. 1604.. TNM. 2204..</p> <p>107.5°</p>	S20R MTQNR / L 16	70,00 €	
	S25S MTQNR / L 16-Z	78,00 €	
	S25S MTQNR / L 16	81,00 €	
	S32T MTQNR / L 16	100,00 €	
	S40U MTQNR / L 16	131,00 €	
	S32T MTQNR / L 22	100,00 €	
	S40U MTQNR / L 22	131,00 €	
	S50V MTQNR / L 22	158,00 €	



M - SYSTEM BORING BARS / BOHRSTANGE M-SYSTEM		PRICE / PREIS
 <p>MTUNR / L TNM. 1604.. TNM. 2204..</p> <p>93°</p>	S20R MTUNR / L 16	70,00 €
	S25S MTUNR / L 16-Z	78,00 €
	S25S MTUNR / L 16	81,00 €
	S32T MTUNR / L 16	100,00 €
	S40U MTUNR / L 16	131,00 €
	S50V MTUNR / L 16	131,00 €
	S32T MTUNR / L 22	100,00 €
	S40U MTUNR / L 22	131,00 €
	S50V MTUNR / L 22	158,00 €
 <p>MWLNR / L WNM. 0604.. WNM. 0804..</p> <p>95°</p>	S16P MWLNR / L 06	67,00 €
	S20R MWLNR / L 06	70,00 €
	S25S MWLNR / L 06	78,00 €
	NEW S20R MWLNR / L 08	78,00 €
	S25S MWLNR / L 08-Z	78,00 €
	S25S MWLNR / L 08	81,00 €
	S32T MWLNR / L 08	100,00 €
	S40U MWLNR / L 08	131,00 €

P - SYSTEM BORING BARS / BOHRSTANGE P-SYSTEM		PRICE / PREIS	
 <p>PCLNR / L CNM. 0903.. CNM. 1204.. CNM. 1606.. CNM. 1906..</p> <p>95°</p>	S16P PCLNR / L 09	67,00 €	
	S20R PCLNR / L 09	70,00 €	
	S25S PCLNR / L 09	81,00 €	
	S25S PCLNR / L 12C	81,00 €	
	S32T PCLNR / L 12C	100,00 €	
	S40U PCLNR / L 12C	131,00 €	
	S50V PCLNR / L 12C	158,00 €	
	S32T PCLNR / L 16C	104,00 €	
	S40U PCLNR / L 16C	139,00 €	
	S50V PCLNR / L 16C	167,00 €	
	S40U PCLNR / L 19C	172,00 €	
	S50V PCLNR / L 19C	200,00 €	
	A20P PCLNR/L 09	83,00 €	
	A25R PCLNR / L 12C	100,00 €	
	NEW A25S PCLNR / L 12C	112,00 €	
	A32S PCLNR / L 12C	120,00 €	
	NEW A32T PCLNR / L 12C	143,00 €	
	A40T PCLNR / L 12C	158,00 €	
	A50U PCLNR / L 12C	192,00 €	
	A32S PCLNR / L 16C	125,00 €	
	A40T PCLNR / L 16C	167,00 €	
	A50U PCLNR / L 16C	200,00 €	
	A40T PCLNR / L 19C	215,00 €	
	A50U PCLNR / L 19C	239,00 €	

S25S MTUNR 16-Z, "-Z": Without Shim / Ohne Unterlegplatte / S25S PCLNR 12, "S": Steel Shank / Ohne Innenkühlung
A25R PCLNR 12, "A": Solid Steel With Coolant Hole / Mit Innenkühlung



Ordering Example / Beispiel Bestellformular: 1pcs. S20R MTUNR 16

P - SYSTEM BORING BARS / BOHRSTANGE P-SYSTEM		PRICE / PREIS
 <p>PDQNR / L DNM. 1104.. DNM. 1504.. DNM. 1506..</p> <p>107.5°</p>	S20R PDQNR / L 11	70,00 €
	S25S PDQNR / L 11	81,00 €
	S32T PDQNR / L 15	100,00 €
	S40U PDQNR / L 15	131,00 €
	S50V PDQNR / L 15	158,00 €
	S32T PDQNR / L 1504	100,00 €
	S40U PDQNR / L 1504	131,00 €
	S50V PDQNR / L 1504	158,00 €
	A20P PDQNR / L 11	83,00 €
	A25R PDQNR / L 11	100,00 €
	A32S PDQNR / L 15	120,00 €
	A40T PDQNR / L 15	158,00 €
	A50U PDQNR / L 15	192,00 €
	A32S PDQNR / L 1504	120,00 €
A40T PDQNR / L 1504	158,00 €	
 <p>PDXNR / L DNM. 1506..</p> <p>93°</p>	S32T PDXNR / L 15	100,00 €
	S40U PDXNR / L 15	131,00 €
	S50V PDXNR / L 15	158,00 €
	A32S PDXNR/L 15	120,00 €
	A40T PDXNR/L 15	158,00 €
	A50U PDXNR/L 15	192,00 €
 <p>PDUNR / L DNM. 1104.. DNM. 1506..</p> <p>93°</p>	S20R PDUNR / L 11	70,00 €
	S25S PDUNR / L 11	81,00 €
	S25S PDUNR / L 15	81,00 €
	S32T PDUNR / L 15	100,00 €
	S40U PDUNR / L 15	131,00 €
	S50V PDUNR / L 15	158,00 €
	A20P PDUNR / L 11	83,00 €
	A25R PDUNR / L 11	100,00 €
	<small>NEW</small> A25S PDUNR / L 11	112,00 €
	A32S PDUNR / L 11	120,00 €
	A32S PDUNR / L 15	120,00 €
	A40T PDUNR / L 15	158,00 €
	A50U PDUNR / L 15	192,00 €
 <p>PSKNR / L SNM. 1204.. SNM. 1506..</p> <p>75°</p>	S25S PSKNR / L 12C	81,00 €
	S32T PSKNR / L 12C	100,00 €
	S40U PSKNR / L 12C	131,00 €
	S50V PSKNR / L 12C	158,00 €
	S32T PSKNR / L 15	104,00 €
	S40U PSKNR / L 15	139,00 €
	S50V PSKNR / L 15	167,00 €
	A25R PSKNR/L 12C	100,00 €
	A32S PSKNR/L 12C	120,00 €
	A32S PSKNR/L 15C	125,00 €
	A40T PSKNR/L 12C	158,00 €
	A40T PSKNR/L 15C	167,00 €
	A50U PSKNR/L 12C	192,00 €
	A50U PSKNR/L 15C	200,00 €

P - SYSTEM BORING BARS / BOHRSTANGE P-SYSTEM			PRICE / PREIS
 <p>PTFNR / L TNM. 1604..</p> <p>90°</p>	A25R PTFNR/L 16C	100,00 €	
	A32S PTFNR/L 16C	100,00 €	
 <p>PTUNR / L TNM. 1604.. TNM. 2204..</p> <p>93°</p>	S16P PTUNR / L 16	67,00 €	
	S20R PTUNR / L 16	70,00 €	
	S25S PTUNR / L 16C	81,00 €	
	S32T PTUNR / L 16C	100,00 €	
	S40U PTUNR / L 16C	131,00 €	
	S32T PTUNR / L 22C	100,00 €	
	S40U PTUNR / L 22C	131,00 €	
	S50V PTUNR / L 22C	158,00 €	
	A16M PTUNR/L 16	50,00 €	
	A20P PTUNR/L 16	83,00 €	
	A25R PTUNR/L 16C	100,00 €	
	A32S PTUNR/L 16C	120,00 €	
	A32S PTUNR/L 22C	120,00 €	
	A40T PTUNR/L 16C	158,00 €	
	A40T PTUNR/L 22C	158,00 €	
 <p>PWLNR / L WNM. 0604.. WNM. 0804..</p> <p>95°</p>	S20R PWLNR / L 06	70,00 €	
	S25S PWLNR / L 06	81,00 €	
	S32T PWLNR / L 06	100,00 €	
	S25S PWLNR / L 08C	81,00 €	
	S32T PWLNR / L 08C	100,00 €	
	S40U PWLNR / L 08C	131,00 €	
	S50V PWLNR / L 08C	158,00 €	
	A16M PWLNR/L 06	50,00 €	
	A20P PWLNR / L 06	83,00 €	
	A25R PWLNR / L 06	100,00 €	
	A32S PWLNR / L 06	120,00 €	
	A40T PWLNR/L 06	158,00 €	
	A25R PWLNR / L 08C	100,00 €	
	A32S PWLNR / L 08C	120,00 €	
	A40T PWLNR / L 08C	158,00 €	
	A50U PWLNR / L 08C	192,00 €	

S25S PWLNR 08, "S": Steel Shank / Ohne Innenkühlung
A25R PWLNR 08, "A": Solid Steel With Coolant Hole / Mit Innenkühlung





Ordering Example / Beispiel Bestellformular: 1pcs. A25R PTFNR 16C



S - SYSTEM BORING BARS / BOHRSTANGE S-SYSTEM		PRICE / PREIS
 <p>SCLCR / L</p> <p>CC.T 0301.. CC.T 0602.. CC.T 09T3.. CC.T 1204..</p> <p>95°</p>	S0508H SCLCR / L 03	52,00 €
	S0608H SCLCR / L 06	29,00 €
	S08H SCLCR / L 06	29,00 €
	S10K SCLCR / L 06	33,00 €
	S12K SCLCR / L 06	35,00 €
	S1216P SCLCR / L 06	40,00 €
	S16P SCLCR / L 06	40,00 €
	S12K SCLCR / L 09	35,00 €
	S1416P SCLCR / L 09	40,00 €
	S16P SCLCR / L 09	40,00 €
	S1620R SCLCR / L 09	42,00 €
	S20R SCLCR / L 09	42,00 €
	S25S SCLCR / L 09-Z	53,00 €
	S25S SCLCR / L 09	56,00 €
	S32T SCLCR / L 09	85,00 €
	S25S SCLCR / L 12-Z	53,00 €
	S25S SCLCR / L 12	56,00 €
	S32T SCLCR / L 12	85,00 €
	S40U SCLCR / L 12	126,00 €
	A08H SCLCR / L 06	35,00 €
A10H SCLCR / L 06	39,00 €	
A12H SCLCR / L 06	42,00 €	
A16M SCLCR / L 09	50,00 €	
A20P SCLCR / L 09	51,00 €	
A25R SCLCR / L 09	71,00 €	
A32S SCLCR / L 09	108,00 €	
A25R SCLCR / L 12	71,00 €	
 <p>SCFCR / L</p> <p>CC.T 0602.. CC.T 09T3..</p> <p>90°</p>	S08H SCFCR / L 06	29,00 €
	S10K SCFCR / L 06	33,00 €
	S12K SCFCR / L 06	35,00 €
	S12K SCFCR / L 09	35,00 €
	S16P SCFCR / L 09	40,00 €
	S20R SCFCR / L 09	42,00 €
	S25S SCFCR / L 09-Z	53,00 €
	S25S SCFCR / L 09	56,00 €
	S25S SCFCR / L 12	56,00 €
	S32T SCFCR / L 12	85,00 €
	S40U SCFCR / L 12	126,00 €
	A08H SCFCR/L 06	35,00 €
	 <p>SD-CR / L</p> <p>DC.T 0702.. DC.T 11T3..</p> <p>62.5°</p>	S10K SD-CR / L 07
S12K SD-CR / L 07		35,00 €
S16P SD-CR / L 07		40,00 €
S16P SD-CR / L 11		40,00 €
S20R SD-CR / L 07		42,00 €
S20R SD-CR / L 11		42,00 €
S25S SD-CR / L 11-Z		53,00 €
S25S SD-CR / L 11		56,00 €
S32T SD-CR / L 11		85,00 €
S40U SD-CR / L 11		126,00 €

S - SYSTEM BORING BARS / BOHRSTANGE S-SYSTEM		PRICE / PREIS
 <p>SDPCR / L</p> <p>DC.T 0702.. DC.T 11T3..</p> <p>117.5°</p>	S10K SDPCR / L 07	33,00 €
	S12K SDPCR / L 07	35,00 €
	S16P SDPCR / L 11	40,00 €
	S20R SDPCR / L 11	42,00 €
	S25S SDPCR / L 11	56,00 €
 <p>SDQCR / L</p> <p>DC.T 0702.. DC.T 11T3..</p> <p>107.5°</p>	S10K SDQCR / L 07	33,00 €
	S12K SDQCR / L 07	35,00 €
	S16P SDQCR / L 07	40,00 €
	S20R SDQCR / L 07	42,00 €
	S16P SDQCR / L 11	40,00 €
	S20R SDQCR / L 11	42,00 €
	S25S SDQCR / L 11-Z	53,00 €
	S25S SDQCR / L 11	56,00 €
	S32T SDQCR / L 11	85,00 €
	S40U SDQCR / L 11	126,00 €
	A10H SDQCR / L 07	39,00 €
	A12H SDQCR / L 07	42,00 €
	A16M SDQCR / L 07	50,00 €
	A20P SDQCR / L 07	51,00 €
	A16M SDQCR / L 11	50,00 €
	A20P SDQCR / L 11	51,00 €
	A25R SDQCR / L 11	71,00 €
	A32S SDQCR / L 11	108,00 €
 <p>SDUCR / L</p> <p>DC.T 0702.. DC.T 11T3..</p> <p>93°</p>	S0810K SDUCR / L 07	34,00 €
	S10K SDUCR / L 07	33,00 €
	S12K SDUCR / L 07	35,00 €
	S1216P SDUCR / L 07	40,00 €
	S1416P SDUCR / L 07	40,00 €
	S16P SDUCR / L 07	40,00 €
	S20R SDUCR / L 07	42,00 €
	S1416P SDUCR / L 11	40,00 €
	S16P SDUCR / L 11	40,00 €
	S1620R SDUCR / L 11	42,00 €
	S20R SDUCR / L 11	42,00 €
	S25S SDUCR / L 11-Z	53,00 €
	S25S SDUCR / L 11	56,00 €
	<small>NEW</small> S25T SDUCR / L 11	66,00 €
	S32T SDUCR / L 11	85,00 €
	S40U SDUCR / L 11	126,00 €
	S50V SDUCR / L 11	152,00 €
	A0810H SDUCR / L 07	39,00 €
	A10H SDUCR / L 07	39,00 €
	A12H SDUCR / L 07	42,00 €
	A16M SDUCR / L 07	50,00 €
	A20P SDUCR / L 07	51,00 €
	A16M SDUCR / L 11	50,00 €
	A20P SDUCR / L 11	51,00 €
	A25R SDUCR / L 11	71,00 €
	<small>NEW</small> A25T SDUCR / L 11	134,00 €
	A32S SDUCR / L 11	108,00 €
<small>NEW</small> A50U SDUCR / L 11	182,00 €	





S25S SDQCR 11-Z, "-Z": Without Shim / Ohne Unterlegplatte / S25S SDQCR 11, "S": Steel Shank / Ohne Innenkühlung
A25R SDQCR 11, "A": Solid Steel With Coolant Hole / Mit Innenkühlung



Ordering Example / Beispiel Bestellformular: 1pcs. S10K SDPCR 07

S - SYSTEM BORING BARS / BOHRSTANGE S-SYSTEM			PRICE / PREIS
 <p>SDXCR / L DC.T 0702.. DC.T 11T3..</p> <p>93°</p>	S12K SDXCR / L 07	35,00 €	
	S16P SDXCR / L 07	40,00 €	
	S20R SDXCR / L 07	42,00 €	
	S16P SDXCR / L 11	40,00 €	
	S20R SDXCR / L 11	42,00 €	
	S25S SDXCR / L 11-Z	53,00 €	
	S25S SDXCR / L 11	56,00 €	
	S32T SDXCR / L 11	85,00 €	
	S40U SDXCR / L 11	126,00 €	
	A12H SDXCR/L 07	42,00 €	
	A16M SDXCR/L 07	50,00 €	
	A16M SDXCR/L 11	50,00 €	
	A20P SDXCR/L 07	51,00 €	
	A20P SDXCR/L 11	51,00 €	
	A25R SDXCR/L 11	71,00 €	
A32S SDXCR/L 11	108,00 €		
 <p>SRGCR / L RC.T 0803..</p> <p>1°</p>	S16P SRGCR / L 08	50,00 €	
	S20R SRGCR / L 08	51,00 €	
	S25S SRGCR / L 08C	71,00 €	
	S32T SRGCR / L 08C	108,00 €	
	S40U SRGCR / L 08C	152,00 €	
	A16M SRGCR/L 08	80,00 €	
	A20P SRGCR/L 08	85,00 €	
	A25R SRGCR/L 08C	115,00 €	
	A32S SRGCR/L 08C	166,00 €	
	A40T SRGCR/L 08C	241,00 €	
 <p>SSSCR / L SC.T 09T3.. SC.T 1204..</p> <p>45°</p>	S16P SSSCR / L 09	40,00 €	
	S20R SSSCR / L 09	42,00 €	
	S25S SSSCR / L 09	56,00 €	
	S25S SSSCR / L 09-Z	53,00 €	
	S25S SSSCR / L 12	56,00 €	
	S32T SSSCR / L 12	85,00 €	
	S40U SSSCR / L 12	126,00 €	
 <p>ST-CR / L TC.T 1102.. TC.T 16T3..</p> <p>60°</p>	S12K ST-CR / L 11	35,00 €	
	S16P ST-CR / L 11	40,00 €	
	S20R ST-CR / L 11	42,00 €	
	S16P ST-CR / L 16	40,00 €	
	S20R ST-CR / L 16	42,00 €	
	S25S ST-CR / L 16-Z	53,00 €	
	S25S ST-CR / L 16	56,00 €	
	S32T ST-CR / L 16	85,00 €	
	S40U ST-CR / L 16	126,00 €	

S - SYSTEM BORING BARS / BOHRSTANGE S-SYSTEM		PRICE / PREIS
 <p>STFCR / L</p> <p>TC.T 06T1.. TC.T 0902.. TC.T 1102.. TC.T 16T3..</p> <p>90°</p>	S0610F STFCR / L 06	42,00 €
	S08H STFCR / L 06	29,00 €
	S10K STFCR / L 09	33,00 €
	S12K STFCR / L 09	35,00 €
	S12K STFCR / L 11	35,00 €
	S16P STFCR / L 11	40,00 €
	S20R STFCR / L 11	42,00 €
	S16P STFCR / L 16	40,00 €
	S20R STFCR / L 16	42,00 €
	S25S STFCR / L 16	56,00 €
	S25S STFCR / L 16	56,00 €
	S32T STFCR / L 16	85,00 €
	S40U STFCR / L 16	126,00 €
	A10H STFCR/L 11	39,00 €
	A12H STFCR/L 11	42,00 €
	A16M STFCR/L 11	50,00 €
 <p>STUCR / L</p> <p>TC.T 0902.. TC.T 1102.. TC.T 16T3..</p> <p>93°</p>	S10K STUCR / L 09	33,00 €
	S12K STUCR / L 09	35,00 €
	S12K STUCR / L 11	35,00 €
	S16P STUCR / L 11	40,00 €
	S20R STUCR / L 11	42,00 €
	S16P STUCR / L 16	40,00 €
	S20R STUCR / L 16	42,00 €
	S25S STUCR / L 16-Z	53,00 €
	S25S STUCR / L 16	56,00 €
	S32T STUCR / L 16	85,00 €
	S40U STUCR / L 16	126,00 €
	A10H STUCR/L 09	39,00 €
	A12H STUCR/L 09	42,00 €
	A12H STUCR/L 11	42,00 €
	A16M STUCR/L 11	50,00 €
	A16M STUCR/L 16	50,00 €
A20P STUCR/L 11	51,00 €	
A20P STUCR/L 16	51,00 €	
A25R STUCR/L 16	71,00 €	
A32S STUCR/L 16	108,00 €	
 <p>STUPR / L</p> <p>TP.. 0802.. TP.. 1103..</p> <p>93°</p>	S08H STUPR / L 0802	37,00 €
	S10K STUPR / L 1103	39,00 €
	S12K STUPR / L 1103	42,00 €
	S12M STUPR / L 1103	48,00 €
	S16P STUPR / L 1103	49,00 €
	S16R STUPR / L 1103	58,00 €
	A20R STUPR/L 1103	57,00 €

S - SYSTEM BORING BARS / BOHRSTANGE S-SYSTEM			PRICE / PREIS
 <p>SVJBR / L VBM. 1604..</p> <p>93°</p>	S25S SVJBR / L 16	67,00 €	
	S32T SVJBR / L 16	85,00 €	
	S40U SVJBR / L 16	126,00 €	
 <p>SVQBR / L VBM. 1103.. VBM. 1604..</p> <p>107.5°</p>	S16P SVQBR / L 11	40,00 €	
	S20R SVQBR / L 11	42,00 €	
	S25S SVQBR / L 16-Z	64,00 €	
	S25S SVQBR / L 16	67,00 €	
	S32T SVQBR / L 16	85,00 €	
	S40U SVQBR / L 16	126,00 €	
	A20Q SVQBR / L 11	51,00 €	
	A20Q SVQBR / L 16	51,00 €	
	A25S SVQBR / L 16	84,00 €	
	A32S SVQBR / L 16	108,00 €	
 <p>SVQCR / L VC.T 1103.. VC.T 1604..</p> <p>107.5°</p>	S16P SVQCR / L 11	40,00 €	
	S20R SVQCR / L 11	42,00 €	
	S25S SVQCR / L 16-Z	64,00 €	
	S25S SVQCR / L 16	67,00 €	
	S32T SVQCR / L 16	85,00 €	
	S40U SVQCR / L 16	126,00 €	
	A16M SVQCR/L 11	50,00 €	
	A20P SVQCR/L 11	51,00 €	
	A25R SVQCR/L 16	84,00 €	
	A32S SVQCR/L 16	108,00 €	
A40T SVQCR/L 16	152,00 €		
 <p>SVUBR / L VBM. 1103.. VBM. 1604..</p> <p>93°</p>	S16P SVUBR / L 11	40,00 €	
	S20R SVUBR / L 11	42,00 €	
	S25S SVUBR / L 16-Z	64,00 €	
	S25S SVUBR / L 16	67,00 €	
	S32T SVUBR / L 16	85,00 €	
	S40U SVUBR / L 16	126,00 €	
	A20Q SVUBR / L 16	51,00 €	
	A32S SVUBR / L 16	108,00 €	
 <p>SVUCR / L VC.T 1103.. VC.T 1604..</p> <p>93°</p>	S16P SVUCR / L 11	40,00 €	
	S20R SVUCR / L 11	42,00 €	
	S25S SVUCR / L 16-Z	64,00 €	
	S25S SVUCR / L 16	67,00 €	
	S32T SVUCR / L 16	85,00 €	
	S40U SVUCR / L 16	126,00 €	
	A12K SVUCR / L 07	47,00 €	
	A20P SVUCR/L 11	51,00 €	
	A20Q SVUCR / L 11	51,00 €	
	A25R SVUCR / L 16	84,00 €	







S - SYSTEM BORING BARS / BOHRSTANGE S-SYSTEM			PRICE / PREIS
 <p>SVXBR / L VBM. 1102.. VBM. 1103.. VBM. 1604.. 93°</p>	S16P SVXBR / L 1102	62,00 €	
	S20R SVXBR / L 1102	64,00 €	
	S16P SVXBR / L 11	40,00 €	
	S20R SVXBR / L 11	42,00 €	
	S25S SVXBR / L 16	67,00 €	
	S32T SVXBR / L 16	85,00 €	
S40U SVXBR / L 16	126,00 €		
 <p>SVJCR / L VC.T 1103.. 93°</p>	S12K SVJCR / L 11	42,00 €	
	S16P SVJCR / L 11	49,00 €	
	S20R SVJCR / L 11	50,00 €	
	A12H SVJCR/L 11	42,00 €	
	A16M SVJCR/L 11	61,00 €	
	A20P SVJCR/L 11	62,00 €	
 <p>SWLCR WC.. 0302.. 95°</p>	S0608H SWLCR 03	29,00 €	
	S0810K SWLCR 03	33,00 €	
 <p>SWUBR WBG 060102-L 93°</p>	S08H SWUBR 06-5.5	38,00 €	
	S08H SWUBR 06-7	38,00 €	
	<small>NEW</small> S08H SWUBL 06-5.5	38,00 €	
	S0610H SWUBR 06	48,00 €	

S-SYSTEM BORING BARS WITH CARBIDE SHANK / BOHRSTANGE MIT VOLLHARTMETALLSCHAFT			PRICE / PREIS
 <p>SCLCR / L CC.T 0602.. CC.T 09T3.. 95°</p>	<small>NEW</small> C04G SCLCR / L 03	105,00 €	
	<small>NEW</small> C05H SCLCR / L 03	116,00 €	
	<small>NEW</small> C06J SCLCR / L 04	127,00 €	
	<small>NEW</small> C07K SCLCR / L 04	141,00 €	
	C06J SCLCR / L 06	139,00 €	
	E08K SCLCR / L 06	155,00 €	
	E10M SCLCR / L 06	224,00 €	
	E12Q SCLCR / L 06	317,00 €	
	E16R SCLCR / L 09	375,00 €	
	E20S SCLCR / L 09	721,00 €	
 <p>SDUCR / L DC.T 0702.. DC.T 11T3.. 93°</p>	E10M SDUCR / L 07	224,00 €	
	E12Q SDUCR / L 07	317,00 €	
	E16R SDUCR / L 11	375,00 €	
	E20S SDUCR / L 11	721,00 €	
 <p>STFCR / L TC.T 0902.. TC.T 1102.. 90°</p>	E10M STFCR 09	224,00 €	
	E12Q STFCR 09	317,00 €	
	E12Q STFCR 11	317,00 €	

S16P SVXBR 1102, "S": Steel Shank / Ohne Innenkühlung

E08K SCLCR 06, "E": Carbide Bar with Fixed Steel Head and Coolant Hole / Vollhartmetall-Bohrstange Mit Gelötetem Stahlkopf und Innenkühlung

Ordering Example / Beispiel Bestellformular: 1pcs. S16P SVXBR 1102

S-SYSTEM BORING BARS WITH CARBIDE SHANK / BOHRSTANGE MIT VOLLHARTMETALLSCHAFT			PRICE / PREIS
 <p>93°</p>	STUPR / L TP. 1103..	E12Q STUPR/L 1103	317,00 €
		E16R STUPR/L 1103	375,00 €
S-SYSTEM BORING BARS SETS / BOHRSTANGEN-SET S-SYSTEM			PRICE / PREIS
 <p>95°</p>	SET-A/SCLCR / L CC.T 0602.. CC.T 09T3..	A08H SCLCR / L 06	197,00 €
		A10H SCLCR / L 06	
 <p>95°</p>	SET-E/SCLCR / L CC.T 0602.. CC.T 09T3..	E08K SCLCR / L 06	1.107,00 €
		E10M SCLCR / L 06	
 <p>95°</p>	SET-S/SCLCR / L CC.T 0602.. CC.T 09T3..	S08H SCLCR / L 06	169,00 €
		S10K SCLCR / L 06	
 <p>93°</p>	SET-A/SDUCR / L DC.T 0702.. DC.T 11T3..	A10H SDUCR / L 07	165,00 €
		A12H SDUCR / L 07	
 <p>93°</p>	SET-E/SDUCR / L DC.T 0702.. DC.T 11T3..	E10M SDUCR / L 07	954,00 €
		E12Q SDUCR / L 07	
 <p>93°</p>	SET-S/SDUCR / L DC.T 0702.. DC.T 11T3..	E16R SDUCR / L 11	140,00 €
		S10K SDUCR / L 07	
		S12K SDUCR / L 07	
		S16P SDUCR / L 11	

ANTI VIBRATION TOOLS / SCHWINGUNGSGEDÄMPFTE BOHRSTANGEN

ANTI VIBRATION TOOLS SHANK / SCHAFT FÜR SCHWINGUNGSGEDÄMPFTE BORSTANGE		PRICE / PREIS
	ATTB-D16-156-7D-H	2060,00 €
	ATTB-D16-204-10D-H-E	auf Anfrage
	ATTB-D20-200-7D-H	1287,00 €
	ATTB-D20-260-10D-H-E	auf Anfrage
	ATTB-D25-255-7D-H	1268,00 €
	ATTB-D25-330-10D-H	auf Anfrage
	ATTB-D32-320-7D-H	1454,00 €
	ATTB-D32-416-10D-H	auf Anfrage
	ATTB-D40-408-7D-H	1640,00 €
	ATTB-D40-528-10D-H	auf Anfrage
	ATTB-D50-519-7D-H	2022,00 €
	ATTB-D50-669-10D-H	auf Anfrage
	ATTB-D60-628-7D-H	2396,00 €
ATTB-D60-808-10D-H	auf Anfrage	

ANTI VIBRATION TOOLS CARTRIDGES / WECHSELKOPF FÜR SCHWINGUNGSGEDÄMPFTE BORSTANGE		PRICE / PREIS	
 93°	SDUCR / L	ATTC-A16 SDUCR/L 07	152,00 €
	DC.T 0702.. DC.T 11T3..	ATTC-A20 SDUCR/L 11	157,00 €
		ATTC-A25 SDUCR/L 11	195,00 €
		ATTC-A32 SDUCR/L 11	233,00 €
		ATTC-A40 SDUCR/L 11	233,00 €
 95°	SCLCR / L	ATTC-A16 SCLCR/L 06	152,00 €
	CC.T 0602.. CC.T 09T3.. CC.T 1204..	ATTC-A20 SCLCR/L 09	157,00 €
		ATTC-A25 SCLCR/L 09	195,00 €
		ATTC-A32 SCLCR/L 09	233,00 €
		ATTC-A40 SCLCR/L 12	233,00 €
 93°	SVUCR / L	ATTC-A20 SVUCR/L 11	157,00 €
	VC.T 1103.. VC.T 1604..	ATTC-A25 SVUCR/L 11	195,00 €
		ATTC-A32 SVUCR/L 16	233,00 €
		ATTC-A40 SVUCR/L 16	233,00 €
 93°	TDUNR / L	ATTC-A32 TDUNR/L 11	233,00 €
	DNM. 1104.. DNM. 1506..	ATTC-A40 TDUNR/L 15	233,00 €



ANTI VIBRATION TOOLS CARTRIDGES / WECHSELKOPF FÜR SCHWINGUNGSGEDÄMPFTE BORSTANGE

		PRICE / PREIS
 <p>95°</p>	TCLNR / L	ATTC-A32 TCLNR/L 12
	CNM. 1204..	ATTC-A40 TCLNR/L 12

233,00 €
233,00 €

CENTERING INSTRUMENT / ZENTRIERWERKZEUG







		PRICE / PREIS
 <p>1°</p>	ATTC	ATTC-16-25
		ATTC-32-60

54,00 €
71,00 €

Ordering Example/Beispiel Bestellformular: 1pcs. ATTC-A32 TCLNR 12





CARTRIDGE / KURZDREHHALTER		PRICE / PREIS	
 <p>90°</p>	SCACR / L CC.T 0602.. CC.T 09T3.. CC.T 1204..	S10X SCACR / L 06 42,00 € S10A SCACR / L 06 42,00 € S1018 SCACR / L 06 42,00 € S1065 SCACR / L 06 42,00 € S10C SCACR / L 06 42,00 € S12B SCACR / L 06 44,00 € S12D SCACR / L 06 51,00 € S12D SCACR / L 09 51,00 € S1265 SCACR / L 09 51,00 € S12H SCACR / L 09 51,00 € S15C SCACR / L 09 51,00 € S1554 SCACR / L 09 51,00 € S15E SCACR / L 09 51,00 € S15D SCACR / L 09 51,00 € S16A SCACR / L 09 51,00 € S16B SCACR / L 09 51,00 € S16C SCACR / L 09 51,00 € S16D SCACR / L 09 51,00 € S16E SCACR / L 09 51,00 € S16G SCACR / L 09 51,00 € S16H SCACR / L 09 51,00 € S1868 SCACR / L 09 54,00 € S18E SCACR / L 09 54,00 € S1888 SCACR / L 09 54,00 € S18105 SCACR / L 09 54,00 € S18175 SCACR / L 09 91,00 € S20E SCACR / L 09 54,00 € S20E SCACR / L 12 54,00 € S20H SCACR / L 12 54,00 €	
	 <p>50°</p>	SCMCN CC.T 0602.. CC.T 09T3..	S10X SCMCN 06 42,00 € NEW S10A SCMCN 06 42,00 € NEW S10B SCMCN 06 42,00 € NEW S10C SCMCN 06 42,00 € NEW S10D SCMCN 06 42,00 € S12D SCMCN 06 51,00 € S16C SCMCN 09 51,00 € S16D SCMCN 09 51,00 €
	 <p>10°</p>	SRSCN RC. 10T3	S12D SRSCN 10 51,00 € S14D SRSCN 10 51,00 € S16D SRSCN 10 51,00 €

CARTRIDGE / KURZDREHHALTER			PRICE / PREIS			
 <p style="text-align: right;">-°</p>	STXCR / L <hr/> TC.T 16T3..	STXCR / L 2020 B16 STXCR / L 2020 E16 STXCR / L 2020 B16-SA STXCR / L 2020 E16-SA STXCR / L 2020 B16-PL STXCR / L 2020 E16-PL STXCR / L 2020 H16-PL	67,00 € 67,00 € 67,00 € 67,00 € 67,00 € 67,00 € 67,00 €			
	 <p style="text-align: right;">90°</p>	SCFCR / L <hr/> CC.T 0602.. CC.T 09T3.. CC.T 1204..	SCFCR / L 06CA 06 SCFCR / L 08CA 06 SCFCR / L 10CA 09 SCFCR / L 12CA 12 SCFCR / L 16CA 12	53,00 € 53,00 € 53,00 € 53,00 € 59,00 €		
		 <p style="text-align: right;">45°</p>	SCSCR / L <hr/> CC.T 0602.. CC.T 09T3.. CC.T 1204..	SCSCR / L 06CA 06 SCSCR / L 10CA 09 SCSCR / L 12CA 12	53,00 € 53,00 € 53,00 €	
			 <p style="text-align: right;">75°</p>	SSKCR / L <hr/> SC.T 09T3..	SSKCR / L 10CA 09 SSKCR / L 12CA 12	53,00 € 53,00 €
				 <p style="text-align: right;">90°</p>	CTFPR / L <hr/> TP.. 16 TP.. 22	CTFPR / L 13CS 16 CTFPR / L 15CS 22
		 <p style="text-align: right;">45°</p>	CTSPR / L <hr/> TP.. 11		CTSPR / L 11.5CS 11	76,00 €
		 <p style="text-align: right;">95°</p>	MSYNR / L <hr/> SNM. 1204..	MSYNR / L 11.5CS 12 MSYNR / L 16CS 12	76,00 € 76,00 €	

CARTRIDGE / KURZDREHHALTER			PRICE / PREIS
 <p>STFCR / L TC.T 0902.. TC.T 1102.. TC.T 16T3..</p> <p>90°</p>	STFCR / L 08CA 09	53,00 €	
	STFCR / L 10CA 11	53,00 €	
	STFCR / L 12CA 16	53,00 €	
	STFCR / L 16CA 16	59,00 €	
 <p>STSCR / L TC.T 0902.. TC.T 1102.. TC.T 16T3..</p> <p>45°</p>	STSCR / L 08CA 09	53,00 €	
	STSCR / L 10CA 11	53,00 €	
	STSCR / L 12CA 16	53,00 €	
 <p>STTCR / L TC.T 0902.. TC.T 1102..</p> <p>60°</p>	STTCR / L 08CA 09	53,00 €	
	STTCR / L 10CA 11	53,00 €	
	NEW STTCR / L 12CA 16	53,00 €	
 <p>PSKNR / L SNM. 1204..</p> <p>75°</p>	PSKNR / L 16CA 12	84,00 €	
 <p>PSRNR / L SNM. 1204..</p> <p>75°</p>	PSRNR / L 16CA 12	84,00 €	
 <p>PTFNR / L TNM. 1604..</p> <p>90°</p>	PTFNR / L 12CA 16	80,00 €	
	PTFNR / L 16CA 16	84,00 €	
	NEW PTFNR / L 16CA 22	86,00 €	
	NEW PTFNR / L 20CA 22	92,00 €	
 <p>PTGNR / L TNMG 2204..</p> <p>90°</p>	PTGNR/L 16CA 22	86,00 €	
 <p>PSDNN SNM. 1204..</p> <p>45°</p>	S22D PSDNN 12C	131,00 €	

EXTERNAL THREADING TOOLHOLDERS / INNEN-GEWINDEDREHHALTER		CUTTING INSERT WENDE PLATTE	PRICE / PREIS
	SER / L 0808 E11		43,00 €
	SER / L 1010 E11	11 ER / L	43,00 €
	SER / L 1212 F11		44,00 €
	SER / L 1616 H11		44,00 €
	SER/L 2020 H11		51,00 €
	SER / L 1616 H16C	16 ER / L	49,00 €
	SER / L 2020 K16C	(0.35-3)	51,00 €
	SER / L 2525 M16C	ISO METRIC	54,00 €
	SER / L 3232 P16C		64,00 €
	SER / L 2525 M22C	22 ER / L	61,00 €
	SER / L 3232 P22C	(3.5-4.5)	70,00 €
	SER / L 4040 S22C	ISO METRIC	105,00 €
	SER / L 2525 M16C-T	16 ER / L (1.5-3) TR	54,00 €
	SER / L 2525 M22C-T	22 ER / L (4-6) TR	61,00 €
	SER / L 2020 K16C-S	SNDVK 166	65,00 €
	SER / L 2525 M16C-S	ER / L 16	69,00 €
SER / L 3232 P16C-S		79,00 €	



INTERNAL THREADING TOOLHOLDERS / GEWINDE-DREHHALTER FÜR INNEN		CUTTING INSERT WENDE PLATTE	PRICE / PREIS
	SIR / L S12X05H 06	06 IR / L	61,00 €
	SIR / L S16X05H 06		61,00 €
	SIR / L S16X07M 08	08 IR / L	43,00 €
	SIR / L S10H 11		43,00 €
	SIR / L S12K 11	11 IR / L	43,00 €
	SIR / L S16X10M 11	ISO	43,00 €
	SIR / L S16X13M 11		43,00 €
	SIR / L S16M 11		43,00 €
	SIR / L S16x13M 16		43,00 €
	SIR / L S16M 16		43,00 €
	SIR / L S20x16P 16	16 IR / L	46,00 €
	SIR / L S20P 16	(0.35-3)	46,00 €
	SIR / L S25R 16C	ISO METRIC	57,00 €
	SIR / L S32S 16C		75,00 €
	SIR / L S40T 16C		96,00 €
	SIR / L S50U 16C		131,00 €
	SIR / L S20P 22		46,00 €
	SIR / L S25R 22C	22 IR / L	61,00 €
	SIR / L S32S 22C	(3.5-4.5)	80,00 €
	SIR / L S40T 22C	ISO METRIC	96,00 €
	SIR / L S50U 22C		131,00 €
	SIR / L S25R 16C-T	16 IR / L (2-3) TR	57,00 €
	SIR / L S32S 16C-T	ISO	75,00 €
	SIR / L S25R 22C-T	22 IR / L (4-6) TR	61,00 €
	SIR / L S32S 22C-T	ISO	80,00 €
	<small>NEW</small> SIR / L A16X13M 16	16 IR / L	56,00 €
	<small>NEW</small> SIR / L A20X16P 16	(0.35-3)	46,00 €
		ISO METRIC	



EXTERNAL THREADING TOOLHOLDERS / INNEN-GEWINDEDREHHALTER		CUTTING INSERT WENDE PLATTE	PRICE / PREIS
	TER / L 1616 H16		54,00 €
	TER / L 2020 K16	16 ER / L	57,00 €
	TER / L 2525 M16	ISO	61,00 €
	TER / L 3232 P16		70,00 €
	TER / L 2525 M22	22 ER / L	70,00 €
	TER / L 3232 P22	ISO	79,00 €
	TER / L 4040 S22		114,00 €
	TER / L 2525 M27	27 ER / L	115,00 €
	TER / L 3232 P27	ISO	126,00 €
	TER / L 4040 S27		167,00 €

INTERNAL THREADING TOOLHOLDERS / GEWINDE-DREHHALTER FÜR INNEN		CUTTING INSERT WENDE PLATTE	PRICE / PREIS
	TIR / L S25R 16		63,00 €
	TIR / L S32S 16	16 IR / L	80,00 €
	TIR / L S40T 16	ISO	101,00 €
	TIR / L S50U 16		138,00 €
	TIR / L S25R 22		70,00 €
	TIR / L S32S 22	22 IR / L	91,00 €
	TIR / L S40T 22	ISO	105,00 €
	TIR / L S50U 22		141,00 €
	TIR / L S32S 27		137,00 €
	TIR / L S40T 27	27 IR / L	152,00 €
	TIR / L S50U 27	ISO	178,00 €
	<small>NEW</small> TIR/L A20P 16		67,00 €
	TIR/L A25R 16	16 IR / L	81,00 €
	TIR/L A32S 16	ISO	100,00 €
	TIR/L A40T 16		127,00 €

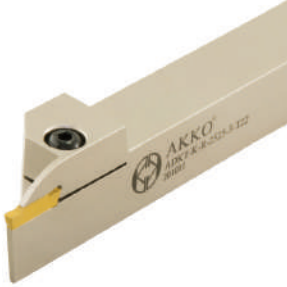
EXTERNAL GROOVING TOOLHOLDERS / AUßEN - STECHHALTER		CUTTING INSERT WENDE PLATTE	PRICE / PREIS
	ADKT-KG-R/L-2020-2-T15	KG.. - 2	110,00 €
	ADKT-KG-R/L-2525-2-T8	KG.. - 2	111,00 €
	ADKT-KG-R/L-2525-2-T15	KG.. - 2	111,00 €
	ADKT-KG-R/L-2525-2-T17	KG.. - 2	111,00 €
	ADKT-KG-R/L-1616-3-T20	KG.. - 3	108,00 €
	ADKT-KG-R/L-2020-3-T20	KG.. - 3	110,00 €
	ADKT-KG-R/L-2525-3-T10	KG.. - 3	111,00 €
	ADKT-KG-R/L-2525-3-T13	KG.. - 3	111,00 €
	ADKT-KG-R/L-2525-3-T22	KG.. - 3	111,00 €
	ADKT-KG-R/L-2020-4-T20	KG.. - 4	110,00 €
	ADKT-KG-R/L-2525-4-T10	KG.. - 4	111,00 €
	ADKT-KG-R/L-2525-4-T16	KG.. - 4	111,00 €
	ADKT-KG-R/L-2525-4-T22	KG.. - 4	111,00 €
	ADKT-KG-R/L-2525-5-T12	KG.. - 5	111,00 €
	ADKT-KG-R/L-2525-5-T15	KG.. - 5	111,00 €
	ADKT-KG-R/L-2525-5-T25	KG.. - 5	111,00 €
	ADKT-KG-R/L-2525-6-T25	KG.. - 6	111,00 €



COMPATIBLE WITH KRLY INSERT
KOMPATIBEL FÜR KRLY WENDESCHNEIDPLATTEN

EXTERNAL GROOVING TOOLHOLDERS / AUßEN - STECHHALTER		CUTTING INSERT WENDE PLATTE	PRICE / PREIS
 <p>COMPATIBLE WITH KRLY- JD INSERT KOMPATIBEL FÜR KRLY WENDESCHNEIDPLATTEN-JD</p>	ADKT-K-R/L-1212-1.5-T15	MGM. - 1.5	85,00 €
	ADKT-K-R/L-2020-1.5-T15	MGM. - 1.5	85,00 €
	ADKT-K-R/L-1212-2-T15	MGM. - 2	83,00 €
	ADKT-K-R/L-1616-2-T10	MGM. - 2	84,00 €
	ADKT-K-R/L-1616-2-T15	MGM. - 2	84,00 €
	ADKT-K-R/L-2020-2-T15	MGM. - 2	85,00 €
	ADKT-K-R/L-2525-2-T15	MGM. - 2	86,00 €
	ADKT-K-R/L-3232-2-T15	MGM. - 2	100,00 €
	ADKT-K-R/L-1212-3-T15	MGM. - 3	83,00 €
	ADKT-K-R/L-1616-3-T15	MGM. - 3	84,00 €
	ADKT-K-R/L-2020-3-T10	MGM. - 3	85,00 €
	ADKT-K-R/L-2020-3-T20	MGM. - 3	85,00 €
	ADKT-K-R/L-2020-3-R28	MGM. - 3	111,00 €
	ADKT-K-R/L-2525-3-T10	MGM. - 3	86,00 €
	ADKT-K-R/L-2525-3-R15	MGM. - 3	86,00 €
	ADKT-K-R/L-2525-3-T22	MGM. - 3	86,00 €
	ADKT-K-R/L-3232-3-T10	MGM. - 3	100,00 €
	ADKT-K-R/L-3232-3-T22	MGM. - 3	100,00 €
	ADKT-K-R/L-2020-4-T10	MGM. -4	85,00 €
	ADKT-K-R/L-2020-4-T20	MGM. -4	85,00 €
	ADKT-K-R/L-2020-4-R25	MGM. -4	102,00 €
	ADKT-K-R/L-2525-4-T10	MGM. -4	86,00 €
	ADKT-K-R/L-2525-4-T18	MGM. -4	86,00 €
	ADKT-K-R/L-2525-4-T22	MGM. -4	86,00 €
	ADKT-K-R/L-3232-4-T10	MGM. -4	100,00 €
	ADKT-K-R/L-3232-4-T22	MGM. -4	100,00 €
	ADKT-K-R/L-2020-5-T20	MGM. -5	85,00 €
	ADKT-K-R/L-2525-5-T15	MGM. -5	86,00 €
	ADKT-K-R/L-2525-5-T18	MGM. -5	86,00 €
	ADKT-K-R/L-2525-5-T25	MGM. -5	86,00 €
	ADKT-K-R/L-3232-5-T15	MGM. -5	100,00 €
	ADKT-K-R/L-3232-5-T25	MGM. -5	100,00 €
	ADKT-K-R/L-2525-6-T15	MGM. -6	86,00 €
ADKT-K-R/L-2525-6-T25	MGM. -6	86,00 €	
ADKT-K-R/L-3232-6-T25	MGM. -6	100,00 €	
ADKT-K-R/L-3232-8-T32	MGM. -8	131,00 €	
 <p>COMPATIBLE WITH SMTM INSERT KOMPATIBEL FÜR SMTM WENDESCHNEIDPLATTEN</p>	ADKT-SGC-R/L-1212-2-R15	GCM N20	107,00 €
	ADKT-SGC-R/L-1616-2-R15	GCM N20	108,00 €
	ADKT-SGC-R/L-2020-2-R20	GCM N20	110,00 €
	ADKT-SGC-R/L-2525-2-R20	GCM N20	111,00 €
	ADKT-SGC-R/L-1212-3-R15	GCM N30	107,00 €
	NEW ADKT-SGC-R/L-1616-3-T12	GCM N30	108,00 €
	ADKT-SGC-R/L-1616-3-R15	GCM N30	108,00 €
	ADKT-SGC-R/L-2020-3-R22	GCM N30	110,00 €
	ADKT-SGC-R/L-2525-3-R15	GCM N30	111,00 €
	ADKT-SGC-R/L-2525-3-R22	GCM N30	111,00 €
	ADKT-SGC-R/L-2525-4-R25	GCM N40	111,00 €

EXTERNAL GROOVING TOOLHOLDERS / AUßEN - STECHHALTER		CUTTING INSERT WENDE PLATTE	PRICE / PREIS
 <p>COMPATIBLE WITH HRN INSERT KOMPATIBEL FÜR HRN WENDESCHNEIDPLATTEN</p>	ADKT-H-R/L-2020-3-T20	S229 - 3	85,00 €
	ADKT-H-R/L-2525-3-T22	S229 - 3	86,00 €
	ADKT-H-R/L-2525-3-T26	S229 - 3	94,00 €
	ADKT-H-R/L-2020-4-T20	S229 - 4	85,00 €
	ADKT-H-R/L-2525-4-T22	S229 - 4	86,00 €
	ADKT-H-R/L-3232-4-T22	S229 - 4	100,00 €
	ADKT-H-R/L-2020-5-T20	S229 - 5	85,00 €
	ADKT-H-R/L-2525-5-T25	S229 - 5	86,00 €
	ADKT-H-R/L-2525-6-T25	S229 - 6	86,00 €
 <p>COMPATIBLE WITH HRN INSERT KOMPATIBEL FÜR HRN WENDESCHNEIDPLATTEN</p>	ADKT-HK-R/L-1616-2-T15	S224 - 2	84,00 €
	ADKT-HK-R/L-2020-2-T15	S224 - 2	85,00 €
	ADKT-HK-R/L-2525-2-T15	S224 - 2	86,00 €
	ADKT-HK-R/L-1616-3-T15	S224 - 3	84,00 €
	ADKT-HK-R/L-2020-3-T20	S224 - 3	85,00 €
	ADKT-HK-R/L-2525-3-T22	S224 - 3	86,00 €
	ADKT-HK-R/L-2020-4-T20	S224 - 4	85,00 €
	ADKT-HK-R/L-2525-4-T22	S224 - 4	86,00 €
	ADKT-HS223-R/L-2020-2-T15	S223 - 2	85,00 €
	ADKT-HS223-R/L-2020-3-T17	S223 - 3	85,00 €

Ordering Example/Beispiel Bestellformular: 1pcs. ADKT-H-R-2020-3-T20











EXTERNAL GROOVING TOOLHOLDERS / AUßEN - STECHHALTER		CUTTING INSERT WENDE PLATTE	PRICE / PREIS
	ADKT-TD-R/L-1212-2-T15	TD. - 2	107,00 €
	ADKT-TD-R/L-1616-2-T8	TD. - 2	108,00 €
	ADKT-TD-R/L-1616-2-T15	TD. - 2	108,00 €
	ADKT-TD-R/L-2020-2-T9	TD. - 2	110,00 €
	ADKT-TD-R/L-2020-2-T15	TD. - 2	110,00 €
	ADKT-TD-R/L-2020-2-T17	TD. - 2	110,00 €
	ADKT-TD-R/L-2020-2-T20	TD. - 2	110,00 €
	ADKT-TD-R/L-2525-2-T8	TD. - 2	111,00 €
	ADKT-TD-R/L-2525-2-T17	TD. - 2	111,00 €
	ADKT-TD-R/L-1212-3-T15	TD. - 3	107,00 €
	ADKT-TD-R/L-1616-3-T15	TD. - 3	108,00 €
	ADKT-TD-R/L-2020-3-T12	TD. - 3	110,00 €
	ADKT-TD-R/L-2020-3-T20	TD. - 3	110,00 €
	ADKT-TD-R/L-2020-3-T25	TD. - 3	114,00 €
	ADKT-TD-R/L-2020-3-T30	TD. - 3	117,00 €
	ADKT-TD-R/L-2525-3-T9	TD. - 3	111,00 €
	ADKT-TD-R/L-2525-3-T12	TD. - 3	111,00 €
	ADKT-TD-R/L-2525-3-T22	TD. - 3	111,00 €
	ADKT-TD-R/L-2525-3-T25	TD. - 3	114,00 €
	ADKT-TD-R/L-2525-3-T30	TD. - 3	119,00 €
ADKT-TD-R/L-3232-3-T25	TD. - 3	124,00 €	
ADKT-TD-R/L-2525-4-T10	TD. - 4	111,00 €	
ADKT-TD-R/L-2525-4-T15	TD. - 4	111,00 €	
ADKT-TD-R/L-2525-4-T22	TD. - 4	111,00 €	
ADKT-TD-R/L-2525-4-T25	TD. - 4	114,00 €	
ADKT-TD-R/L-2525-4-T30	TD. - 4	119,00 €	
ADKT-TD-R/L-2525-5-T25	TD. - 5	111,00 €	
	ADKT-RD-R/L-1616-2-T17	RD. - 2	108,00 €
	ADKT-RD-R/L-2020-2-T17	RD. - 2	110,00 €
	ADKT-RD-R/L-2525-2-T17	RD. - 2	111,00 €
	ADKT-RD-R/L-1616-3-T20	RD. - 3	108,00 €
	ADKT-RD-R/L-2020-3-T25	RD. - 3	114,00 €
	ADKT-RD-R/L-2525-3-T25	RD. - 3	114,00 €
ADKT-RD-R/L-2020-4-T30	RD. - 4	117,00 €	
ADKT-RD-R/L-2525-4-T30	RD. - 4	119,00 €	
	ADKT-ITG-R/L-2020-3-T8	TGM. - 3	105,00 €
	ADKT-ITG-R/L-2525-3-T8	TGM. - 3	106,00 €
	ADKT-ITG-R/L-3232-3-T8	TGM. - 3	124,00 €
	ADKT-ITG-R/L-2020-4-T9	TGM. - 4	105,00 €
	ADKT-ITG-R/L-2525-4-T17	TGM. - 4	106,00 €
	ADKT-ITG-R/L-3232-4-T17	TGM. - 4	124,00 €
	ADKT-ITG-R/L-3232-5-T25	TGM. - 5	124,00 €

COMPATIBLE WITH TGTC INSERT
KOMPATIBEL FÜR TGTC WENDESCHNEIDPLATTEN

COMPATIBLE WITH TGTC INSERT
KOMPATIBEL FÜR TGTC WENDESCHNEIDPLATTEN

COMPATIBLE WITH ISCR INSERT
KOMPATIBEL FÜR ISCR WENDESCHNEIDPLATTEN



EXTERNAL GROOVING TOOLHOLDERS / AUßEN - STECHHALTER		CUTTING INSERT WENDE PLATTE	PRICE / PREIS
 <p>COMPATIBLE WITH SNDVK INSERT KOMPATIBEL FÜR SNDVK WENDESCHNEIDPLATTEN</p>	ADKT-123-R/L-1212-1.5-R15	123 - 1.5	83,00 €
	ADKT-123-R/L-1616-1.5-R15	123 - 1.5	84,00 €
	<small>NEW</small> ADKT-123-R/L-2012-1.5-R15	123 - 1.5	85,00 €
	ADKT-123-R/L-1616-2-T15	123 - 2	84,00 €
	ADKT-123-R/L-2020-2-T8	123 - 2	85,00 €
	ADKT-123-R/L-2020-2-T15	123 - 2	85,00 €
	ADKT-123-R/L-2525-2-T8	123 - 2	86,00 €
	ADKT-123-R/L-2525-2-T15	123 - 2	86,00 €
	ADKT-123-R/L-3232-2-T15	123 - 2	124,00 €
	ADKT-123-R/L-1616-3-T10	123 - 3	84,00 €
	ADKT-123-R/L-1616-3-T15	123 - 3	84,00 €
	ADKT-123-R/L-2020-3-T10	123 - 3	85,00 €
	ADKT-123-R/L-2020-3-T15	123 - 3	85,00 €
	ADKT-123-R/L-2020-3-T20	123 - 3	85,00 €
	ADKT-123-R/L-2525-3-T10	123 - 3	86,00 €
	ADKT-123-R/L-2525-3-T15	123 - 3	86,00 €
	ADKT-123-R/L-2525-3-T22	123 - 3	86,00 €
	ADKT-123-R/L-2020-4-T20	123 - 4	85,00 €
	ADKT-123-R/L-2525-4-T13	123 - 4	86,00 €
	ADKT-123-R/L-2525-4-T22	123 - 4	86,00 €
ADKT-123-R/L-3232-4-T25	123 - 4	124,00 €	
ADKT-123-R/L-2020-5-T20	123 - 5	85,00 €	
ADKT-123-R/L-2525-5-T25	123 - 5	86,00 €	
ADKT-123-R/L-3232-6-T15	123 - 6	124,00 €	
 <p>COMPATIBLE WITH SNDVK INSERT KOMPATIBEL FÜR SNDVK WENDESCHNEIDPLATTEN</p>	ADKT-151.22-R/L-1616-2-T15	151.2 - 2	84,00 €
	ADKT-151.22-R/L-2020-2-T15	151.2 - 2	85,00 €
	ADKT-151.22-R/L-2525-2-T15	151.2 - 2	86,00 €
	ADKT-151.22-R/L-1616-3-T15	151.2 - 3	84,00 €
	ADKT-151.22-R/L-2020-3-T20	151.2 - 3	85,00 €
	ADKT-151.22-R/L-2525-3-T22	151.2 - 3	86,00 €
	ADKT-151.22-R/L-1616-4-T15	151.2 - 4	84,00 €
	ADKT-151.22-R/L-2020-4-T20	151.2 - 4	85,00 €
	ADKT-151.22-R/L-2525-4-T22	151.2 - 4	86,00 €
ADKT-151.22-R/L-2020-5-T20	151.2 - 5	85,00 €	
ADKT-151.22-R/L-2525-5-T25	151.2 - 5	86,00 €	
 <p>COMPATIBLE WITH SMTM INSERT KOMPATIBEL FÜR SMTM WENDESCHNEIDPLATTEN</p>	ADKT-SWC-R/L-2020-2-T25	WCF. - 2	120,00 €
	ADKT-SWC-R/L-2020-3-T25	WCF. - 3	120,00 €
 <p><small>NEW</small> COMPATIBLE WITH MTSBH INSERT KOMPATIBEL FÜR MTSBH WENDESCHNEIDPLATTEN</p>	ADKT-GY2-R/L-2525-2-R20	GY2M0200	135,00 €
	ADKT-GY2-R/L-2525-3-R20	GY2M0300	135,00 €
	ADKT-GY2-R/L-2525-4-T25	GY2M0400	135,00 €
	ADKT-GY2-R/L-2525-5-T25	GY2M0500	135,00 €

EXTERNAL GROOVING TOOLHOLDERS / AUßEN - STECHHALTER		CUTTING INSERT WENDE PLATTE	PRICE / PREIS
 <p>COMPATIBLE WITH SNDVK INSERT KOMPATIBEL FÜR SNDVK WENDESCHNEIDPLATTEN</p>	ADKT-151.23-R/L-1616-2-T15	151.2 - 2	84,00 €
	ADKT-151.23-R/L-2020-2-T15	151.2 - 2	85,00 €
	ADKT-151.23-R/L-2525-2-T15	151.2 - 2	86,00 €
	ADKT-151.23-R/L-1616-2.5-T15	151.2 - 2.5	84,00 €
	ADKT-151.23-R/L-2020-2.5-T15	151.2 - 2.5	85,00 €
	ADKT-151.23-R/L-2525-2.5-T15	151.2 - 2.5	86,00 €
	ADKT-151.23-R/L-1212-3-T15	151.2 - 3	83,00 €
	ADKT-151.23-R/L-1616-3-T15	151.2 - 3	84,00 €
	ADKT-151.23-R/L-2020-3-T20	151.2 - 3	85,00 €
	ADKT-151.23-R/L-2525-3-T20	151.2 - 3	86,00 €
	ADKT-151.23-R/L-2525-3-T22	151.2 - 3	86,00 €
	ADKT-151.23-R/L-1616-4-T15	151.2 - 4	84,00 €
	ADKT-151.23-R/L-2020-4-T20	151.2 - 4	85,00 €
	ADKT-151.23-R/L-2525-4-T22	151.2 - 4	86,00 €
	ADKT-151.23-R/L-2020-5-T20	151.2 - 5	85,00 €
ADKT-151.23-R/L-2525-5-T25	151.2 - 5	86,00 €	
 <p>COMPATIBLE WITH SNDVK INSERT KOMPATIBEL FÜR SNDVK WENDESCHNEIDPLATTEN</p>	ADKT-154.91-R/L-2020-3-T4	154.91 - 3	85,00 €
	ADKT-154.91-R/L-2525-3-T4	154.91 - 3	86,00 €
	ADKT-154.91-R/L-2020-5-T5	154.91 - 5	85,00 €
	ADKT-154.91-R/L-2525-5-T5	154.91 - 5	86,00 €
 <p>COMPATIBLE WITH ARN INSERT KOMPATIBEL FÜR ARN WENDESCHNEIDPLATTEN</p>	ADKT-ARN-R/L-2020-2-T15	LOMR. - 2	85,00 €
	ADKT-ARN-R/L-2525-2-T15	LOMR. - 2	86,00 €
	ADKT-ARN-R/L-2020-3-T20	LOMR. - 3	85,00 €
	ADKT-ARN-R/L-2525-3-T22	LOMR. - 3	86,00 €
 <p>COMPATIBLE WITH SMTM INSERT KOMPATIBEL FÜR SMTM WENDESCHNEIDPLATTEN</p>	ADKT-SGC-R/L-1212-2-R15	GCM N20	107,00 €
	ADKT-SGC-R/L-1616-2-R15	GCM N20	108,00 €
	ADKT-SGC-R/L-2020-2-R20	GCM N20	110,00 €
	ADKT-SGC-R/L-2525-2-R20	GCM N20	111,00 €
	ADKT-SGC-R/L-1212-3-R15	GCM N30	107,00 €
	ADKT-SGC-R/L-1616-3-R15	GCM N30	108,00 €
	ADKT-SGC-R/L-2020-3-R22	GCM N30	110,00 €
	ADKT-SGC-R/L-2525-3-R15	GCM N30	111,00 €
	ADKT-SGC-R/L-2525-3-R22	GCM N30	111,00 €
	ADKT-SGC-R/L-2525-4-R25	GCM N40	111,00 €
 <p>COMPATIBLE WITH HRN INSERT KOMPATIBEL FÜR HRN WENDESCHNEIDPLATTEN</p>	ADKT-H22-R/L-1616-(0.5-2)-T4	S312 - (0.5-2)	84,00 €
	ADKT-H22-R/L-2020-(0.5-2)-T4	S312 - (0.5-2)	85,00 €
	NEW ADKT-H22-R-2020-(0.5-2)-T6x20	S312 - (0.5-2)	85,00 €
	ADKT-H22-R/L-2525-(0.5-2)-T4	S312 - (0.5-2)	86,00 €
	NEW ADKT-H22-R/L-2525-(0.5-2)-T6x20	S312 - (0.5-2)	86,00 €

EXTERNAL GROOVING TOOLHOLDERS / AUßEN - STECHHALTER		CUTTING INSERT WENDE PLATTE	PRICE / PREIS
 <p>COMPATIBLE WITH TNGLY INSERT KOMPATIBEL FÜR TNGLY WENDESCHNEIDPLATTEN</p>	ADKT-TG-R/L-1616-2-R17	DGM2 - 020	108,00 €
	NEW ADKT-TG-R/L-2020-2-T8	DGM2 - 020	110,00 €
	ADKT-TG-R/L-2020-2-R12	DGM2 - 020	110,00 €
	ADKT-TG-R/L-2020-2-R17	DGM2 - 020	110,00 €
	ADKT-TG-R/L-2525-2-R12	DGM2 - 020	111,00 €
	ADKT-TG-R/L-2525-2-R17	DGM2 - 020	111,00 €
	ADKT-TG-R/L-1616-3-T20	DGM3 - 020	108,00 €
	ADKT-TG-R/L-2020-3-T12	DGM3 - 020	110,00 €
	ADKT-TG-R/L-2020-3-T20	DGM3 - 020	110,00 €
	ADKT-TG-R/L-2525-3-T9	DGM3 - 020	111,00 €
	ADKT-TG-R/L-2525-3-T20	DGM3 - 020	111,00 €
	ADKT-TG-R/L-2525-3-R25	DGM3 - 020	114,00 €
	ADKT-TG-R/L-2525-4-T15	DGM4 - 030	111,00 €
	ADKT-TG-R/L-2525-4-T20	DGM4 - 030	111,00 €
	ADKT-TG-R/L-2525-4-T25	DGM4 - 030	114,00 €
	ADKT-TG-R/L-2525-5-T12	DGM5 - 030	111,00 €
ADKT-TG-R/L-2525-5-T25	DGM5 - 030	111,00 €	
ADKT-TG-R/L-2525-5-T32	DGM5 - 030	119,00 €	
 <p>COMPATIBLE WITH LMNA INSERT KOMPATIBEL FÜR LMNA WENDESCHNEIDPLATTEN</p>	ADKT-LGC-R/L-1616-2-D40	GCTX - 2	108,00 €
	ADKT-LGC-R/L-2020-2-D40	GCTX - 2	110,00 €
	ADKT-LGC-R/L-2525-2-D40	GCTX - 2	111,00 €
	ADKT-LGC-R/L-1616-3-T20	GCTX - 3	108,00 €
	ADKT-LGC-R/L-2020-3-T20	GCTX - 3	110,00 €
	ADKT-LGC-R/L-2525-3-T20	GCTX - 3	111,00 €
 <p>COMPATIBLE WITH WLTR INSERT KOMPATIBEL FÜR WLTR WENDESCHNEIDPLATTEN</p>	ADKT-WGX16-R/L-2020-2-R16	GX16. - 2	110,00 €
	ADKT-WGX16-R/L-2525-2-R16	GX16. - 2	111,00 €
	ADKT-WGX24-R/L-2020-3-T20	GX24. - 3	110,00 €
	ADKT-WGX24-R/L-2525-3-T12	GX24. - 3	111,00 €
	ADKT-WGX24-R/L-2525-3-T22	GX24. - 3	111,00 €
	ADKT-WGX24-R/L-3232-3-T22	GX24. - 3	127,00 €
	ADKT-WGX24-R/L-2525-4-T22	GX24. - 4	111,00 €
	ADKT-WGX24-R/L-2525-5-T25	GX24. - 5	111,00 €
	ADKT-WGX24-R/L-3232-5-T25	GX24. - 5	127,00 €
 <p>COMPATIBLE WITH PLBT INSERT KOMPATIBEL FÜR PLBT WENDESCHNEIDPLATTEN</p>	ADKT-GP-R/L-2020-2-T15	GP - 2	110,00 €
	ADKT-GP-R/L-2525-2-T15	GP - 2	111,00 €
	ADKT-GP-R/L-2020-3-T20	GP - 3	110,00 €
	ADKT-GP-R/L-2525-3-T22	GP - 3	111,00 €
	ADKT-GP-R/L-2525-4-T22	GP - 4	111,00 €
	ADKT-GP-R/L-2525-5-T25	GP - 5	111,00 €
 <p>COMPATIBLE WITH CRTZT INSERT KOMPATIBEL FÜR CRTZT WENDESCHNEIDPLATTEN</p>	ADKT-CD-R/L-2020-3-R20	GX24 0300	85,00 €
	ADKT-CD-R/L-2525-3-R23	GX24 0300	86,00 €



EXTERNAL GROOVING TOOLHOLDERS / AUßEN - STECHHALTER		CUTTING INSERT WENDE PLATTE	PRICE / PREIS
 <p>COMPATIBLE WITH XTC-GSC INSERT KOMPATIBEL FÜR XTC-GSCWENDESCHNEIDPLATTEN</p>	ADKT-GB-R/L-1212-3	GB3100	83,00 €
	ADKT-GB-R/L-1616-3	GB3100	84,00 €
	ADKT-GB-R/L-2020-3	GB3100	85,00 €
 <p>COMPATIBLE WITH NTK INSERT KOMPATIBEL FÜR NTK WENDESCHNEIDPLATTEN</p>	ADKT-TGF-R/L-1616-3	QC16L150-R02	84,00 €
	ADKT-TGF-R/L-2020-3	QC16L150-R02	85,00 €
	ADKT-TGF-R/L-2525-3	QC16L150-R02	86,00 €
L TYPE FACE GROOVING TOOLHOLDERS / AXIAL - STECHHALTER L TYPE		CUTTING INSERT WENDE PLATTE	PRICE / PREIS
 <p>COMPATIBLE WITH CZZ INSERT KOMPATIBEL FÜR CZZ WENDESCHNEIDPLATTEN</p>	ALKT-ZCC2-R/L-2525-35-45-3-T10	Z.FD - 3	138,00 €
	ALKT-ZCC2-R/L-2525-39-55-3-T10	Z.FD - 3	138,00 €
	ALKT-ZCC2-R/L-2525-35- \varnothing -3-T4	Z.FD - 3	138,00 €
	ALKT-ZCC2-R/L-2525-40-60-4-T14	Z.GD - 4	138,00 €
	ALKT-ZCC2-R/L-2525-52-80-4-T14	Z.GD - 4	138,00 €
	ALKT-ZCC2-R/L-2525-72-110-4-T14	Z.GD - 4	138,00 €
	ALKT-ZCC2-R/L-2525-100-230-4-T14	Z.GD - 4	138,00 €
	ALKT-ZCC2-R/L-2525-40- \varnothing -4-T4	Z.GD - 4	138,00 €
EXTERNAL GROOVING TOOLHOLDERS FOR SWISS TYPE SLIDING AUTOMATIC LATHES Werkzeuge zur Stechbearbeitung auf Langdrehautomaten		CUTTING INSERT WENDE PLATTE	PRICE / PREIS
 <p>COMPATIBLE WITH TGTC INSERT KOMPATIBEL FÜR TGTC WENDESCHNEIDPLATTEN</p>	ADKT-TD-R/L-1010-2-R10-K-S	TD. - 2	107,00 €
	ADKT-TD-R/L-1212-2-T12-K-S	TD. - 2	107,00 €
	ADKT-TD-R/L-1616-2-T16-K-S	TD. - 2	108,00 €
	ADKT-TD-R/L-1212-3-T12-K-S	TD. - 3	107,00 €
	ADKT-TD-R/L-1616-3-T16-K-S	TD. - 3	108,00 €
 <p>COMPATIBLE WITH TGTC INSERT KOMPATIBEL FÜR TGTC WENDESCHNEIDPLATTEN</p>	ADKT-RD-R/L-1212-2-T12-K-S	RD. - 2	107,00 €
	ADKT-RD-R/L-1616-2-T17-K-S	RD. - 2	108,00 €
	ADKT-RD-R/L-1212-3-T12-K-S	RD. - 3	107,00 €
 <p>COMPATIBLE WITH ZCC INSERT KOMPATIBEL FÜR ZCC WENDESCHNEIDPLATTEN</p>	ADKT-ZCC2-R/L-1010-2-T12-K-S	Z.BD - 2	107,00 €
	ADKT-ZCC2-R/L-1212-2-T12-K-S	Z.BD - 2	107,00 €
	ADKT-ZCC2-R/L-1616-2-R16-K-S	Z.BD - 2	108,00 €
	ADKT-ZCC2-R/L-1212-3-T12-K-S	Z.FD - 3	107,00 €



EXTERNAL GROOVING TOOLHOLDERS FOR SWISS TYPE SLIDING AUTOMATIC LATHES Werkzeuge zur Stechbearbeitung auf Langdrehautomaten		CUTTING INSERT WENDE PLATTE	PRICE / PREIS
 <p>COMPATIBLE WITH KRLY INSERT KOMPATIBEL FÜR KRLY WENDESCHNEIDPLATTEN</p>	ADKT-KG-R/L-1212-2-R12-K-S	KG. - 2	117,00 €
	ADKT-KG-R/L-1616-2-R16-K-S	KG. - 2	119,00 €
	ADKT-KG-R/L-1212-3-R12-K-S	KG. - 3	117,00 €
	ADKT-KG-R/L-1616-3-R16-K-S	KG. - 3	119,00 €
 <p>COMPATIBLE WITH KRLY INSERT KOMPATIBEL FÜR KRLY WENDESCHNEIDPLATTEN</p>	ADKT-K-R/L-1212-2-R12-K-S	MGM. - 2	107,00 €
	ADKT-K-R/L-1616-2-R16-K-S	MGM. - 2	108,00 €
	ADKT-K-R/L-1212-3-R12-K-S	MGM. - 3	107,00 €
	ADKT-K-R/L-1616-3-R16-K-S	MGM. - 3	108,00 €
 <p>COMPATIBLE WITH SNDVK INSERT KOMPATIBEL FÜR SNDVK WENDESCHNEIDPLATTEN</p>	ADKT-123-R/L-1212-2-T12-K-S	123 - 2	117,00 €
 <p>COMPATIBLE WITH ISCR INSERT KOMPATIBEL FÜR ISCR WENDESCHNEIDPLATTEN</p>	ADKT-I-R/L-0808-2-R10-S	DGN - 2	105,00 €
	ADKT-I-R/L-1010-2-R10-K-S	DGN - 2	107,00 €
	ADKT-I-R/L-1212-2-R12-K-S	DGN - 2	107,00 €
	NEW ADKT-I-R/L-1616-2-R16-K-S	DGN - 2	107,00 €
	ADKT-I-R/L-1616-3-R16-K-S	DGN - 3	107,00 €
	ADKT-I-R/L-1616-3-R16-K-S	DGN - 3	107,00 €
 <p>COMPATIBLE WITH WLTR INSERT KOMPATIBEL FÜR WLTR WENDESCHNEIDPLATTEN</p>	ADKT-WGX16-R/L-1212-2-R12-K-S	GX16. - 2	107,00 €
	ADKT-WGX16-R/L-1616-2-R16-K-S	GX16. - 2	108,00 €
	ADKT-WGX24-R/L-1616-3-R16-K-S	GX24. - 3	124,00 €
 <p>COMPATIBLE WITH TNGLY INSERT KOMPATIBEL FÜR TNGLY WENDESCHNEIDPLATTEN</p>	ADKT-TG-R/L-1212-2-R12-K-S	DGM2 - 020	107,00 €
	ADKT-TG-R/L-1212-3-R12-K-S	DGM3 - 020	107,00 €



FACE GROOVING TOOLHOLDERS / AXIAL- STECHHALTER		CUTTING INSERT WENDE PLATTE	PRICE / PREIS
 <p>COMPATIBLE WITH KRLY INSERT KOMPATIBEL FÜR KRLY WENDESCHNEIDPLATTEN</p>	AAKT-K-R/L-2525-34-45-3-T17	MGM. - 3	131,00 €
	AAKT-K-R/L-2525-39-55-3-T17	MGM. - 3	131,00 €
	AAKT-K-R/L-2525-49-80-3-T17	MGM. - 3	131,00 €
	AAKT-K-R/L-2525-70-110-3-T17	MGM. - 3	131,00 €
	AAKT-K-R/L-2525-100-150-3-T17	MGM. - 3	131,00 €
	AAKT-K-R/L-2525-80-180-3-T32	MGM. - 3	138,00 €
	AAKT-K-R/L-2525-175-215-3-T22	MGM. - 3	131,00 €
	AAKT-K-R/L-2525-700-800-3-T17	MGM. - 3	131,00 €
	AAKT-K-R/L-2525-50-85-4-T22	MGM. - 4	131,00 €
	AAKT-K-R/L-2525-70-110-4-T22	MGM. - 4	131,00 €
	AAKT-K-R/L-2525-100-150-4-T22	MGM. - 4	131,00 €
	AAKT-K-R/L-2525-80-180-4-T32	MGM. - 4	138,00 €
	AAKT-K-R/L-2525-180-800-4-T32	MGM. - 4	138,00 €
	AAKT-K-R/L-2525-70-110-5-T25	MGM. - 5	131,00 €
	AAKT-K-R/L-2525-100-150-5-T25	MGM. - 5	131,00 €
	AAKT-K-R/L-2525-140-200-5-T25	MGM. - 5	131,00 €
	AAKT-K-R/L-2525-80-180-5-T32	MGM. - 5	138,00 €
	AAKT-K-R/L-2525-180-800-5-T32	MGM. - 5	138,00 €
	NEW AAKT-K-R/L-2525-180-800-5-T40	MGM. - 5	173,00 €
	AAKT-K-R/L-2525-60-100-6-T25	MGM. - 6	131,00 €
	AAKT-K-R/L-2525-60-100-6-T35	MGM. - 6	143,00 €
	AAKT-K-R/L-2525-100-200-6-T25	MGM. - 6	131,00 €
	AAKT-K-R/L-2525-100-200-6-T35	MGM. - 6	143,00 €
	AAKT-K-R/L-2525-100-200-6-T45	MGM. - 6	173,00 €
	AAKT-K-R/L-2525-140-300-6-T35	MGM. - 6	143,00 €
	NEW AAKT-K-R/L-2525-180-360-6-T40	MGM. - 6	173,00 €
	AAKT-K-R/L-2525-140-300-8-T35	MGM. - 8	151,00 €
AAKT-K-R/L-3232-140-350-8-T35	MGM. - 8	162,00 €	
 <p>COMPATIBLE WITH ZCC INSERT KOMPATIBEL FÜR ZCC WENDESCHNEIDPLATTEN</p>	AAKT-ZCC2-R/L-2525-140-180-2-T4	Z.BD - 2	131,00 €
	AAKT-ZCC2-R/L-2525-35-45-3-T17	Z.FD - 3	131,00 €
	AAKT-ZCC2-R/L-2525-39-55-3-T17	Z.FD - 3	131,00 €
	AAKT-ZCC2-R/L-2525-49-80-3-T17	Z.FD - 3	131,00 €
	NEW AAKT-ZCC2-R/L-2525-70-110-3-T15	Z.FD - 3	131,00 €
	AAKT-ZCC2-R/L-2525-70-110-3-T17	Z.FD - 3	131,00 €
	AAKT-ZCC2-R/L-2525-100-150-3-T17	Z.FD - 3	131,00 €
	AAKT-ZCC2-R/L-2525-100-150-3-T22	Z.FD - 3	131,00 €
	AAKT-ZCC2-R/L-2525-40-60-4-T22	Z.GD - 4	131,00 €
	AAKT-ZCC2-R/L-2525-52-80-4-T22	Z.GD - 4	131,00 €
	AAKT-ZCC2-R/L-2525-72-110-4-T22	Z.GD - 4	131,00 €
	AAKT-ZCC2-R/L-2525-100-150-4-T22	Z.GD - 4	131,00 €
	AAKT-ZCC2-R/L-2525-140-200-4-T22	Z.GD - 4	131,00 €
	AAKT-ZCC2-R/L-2525-55-95-5-T25	Z.HD - 5	131,00 €
	AAKT-ZCC2-R/L-2525-85-140-5-T25	Z.HD - 5	131,00 €
	AAKT-ZCC2-R/L-2525-130-200-5-T25	Z.HD - 5	131,00 €
	AAKT-ZCC2-R/L-2525-190-400-5-T25	Z.HD - 5	131,00 €
	AAKT-ZCC2-R/L-2525-190-400-5-T35	Z.HD - 5	156,00 €
	AAKT-ZCC2-R/L-2525-200-500-5-T17	Z.HD - 5	131,00 €
	AAKT-ZCC2-R/L-2525-60-110-6-T15	Z.KD - 6	131,00 €
	AAKT-ZCC2-R/L-3232-160-400-6-T25	Z.KD - 6	131,00 €
	 <p>COMPATIBLE WITH KRLY INSERT KOMPATIBEL FÜR KRLY WENDESCHNEIDPLATTEN</p>	AAKT-KG-R/L-2525-44-70-4-T22	KG. - 4
AAKT-KG-R/L-2525-60-120-4-T22		KG. - 4	144,00 €
AAKT-KG-R/L-2525-112-200-4-T22		KG. - 4	144,00 €

FACE GROOVING TOOLHOLDERS / AXIAL- STECHHALTER		CUTTING INSERT WENDE PLATTE	PRICE / PREIS
 <p>COMPATIBLE WITH ISCR INSERT KOMPATIBEL FÜR ISCR WENDESCHNEIDPLATTEN</p>	AAKT-IG-R/L-2525-40-60-4-T25	DGN / GRP - 4	152,00 €
	AAKT-IG-R/L-2525-52-80-4-T25	DGN / GRP - 4	152,00 €
	AAKT-IG-R/L-2525-70-110-4-T28	DGN / GRP - 4	152,00 €
	AAKT-IG-R/L-2525-72-110-4-T25	DGN / GRP - 4	152,00 €
	AAKT-IG-R/L-2525-100-150-4-T25	DGN / GRP - 4	152,00 €
	AAKT-IG-R/L-2525-110-200-4-T28	DGN / GRP - 4	152,00 €
	AAKT-IG-R/L-2525-110-200-4-T32	DGN / GRP - 4	152,00 €
	AAKT-IG-R/L-2525-140-200-4-T25	DGN / GRP - 4	152,00 €
	AAKT-IG-R/L-2525-180-800-4-T28	DGN / GRP - 4	152,00 €
	AAKT-IG-R/L-2525-200-800-4-T25	DGN / GRP - 4	152,00 €
	AAKT-IG-R/L-2525-70-110-5-T32	DGN / GRP - 5	152,00 €
	AAKT-IG-R/L-2525-110-200-5-T32	DGN / GRP - 5	152,00 €
	AAKT-IG-R/L-2525-110-200-5-T9	DGN / GRP - 5	152,00 €
	AAKT-IG-R/L-2525-180-800-5-T32	DGN / GRP - 5	152,00 €
	AAKT-IG-R/L-2525-58-100-6-T32	DGN / GRP - 6	152,00 €
	AAKT-IG-R/L-2525-88-180-6-T32	DGN / GRP - 6	152,00 €
 <p>COMPATIBLE WITH SMTM INSERT KOMPATIBEL FÜR SMTM WENDESCHNEIDPLATTEN</p>	AAKT-SGC-R/L-2020-22-53-3-T13	GCM N3002	152,00
	AAKT-SGC-R/L-2525-80-100-3-T8	GCM N3002	152,00
	AAKT-SGC-R/L-2525-40-65-4-T12	GCM N4020	152,00
	AAKT-SGC-R/L-2525-80-140-4-T8	GCM N4020	152,00
 <p>COMPATIBLE WITH WLTR INSERT KOMPATIBEL FÜR WLTR WENDESCHNEIDPLATTEN</p>	AAKT-WGX24-R-2525-58-100-6-T32	GX24-6	152,00
	AAKT-WGX24-R-2525-88-180-6-T32	GX24-6	152,00
BLADES FOR PARTING AND DEEP GROOVING / STECHSCHWERT ZUR AUBENBEARBEITUNG		CUTTING INSERT WENDE PLATTE	PRICE / PREIS
 <p>COMPATIBLE WITH SMTM INSERT KOMPATIBEL FÜR SMTM WENDESCHNEIDPLATTEN</p>	AKL-SGC-26-3	GCM N30	117,00 €
	AKL-SGC-32-3	GCM N30	125,00 €
 <p>COMPATIBLE WITH ISCR INSERT KOMPATIBEL FÜR ISCR WENDESCHNEIDPLATTEN</p>	AKL-I-26-2	DGN - 2	117,00 €
	AKL-I-32-2	DGN - 2	125,00 €
	AKL-I-26-3	DGN - 3	117,00 €
	AKL-I-32-3	DGN - 3	125,00 €
	AKL-I-26-4	DGN / GRP - 4	117,00 €
	AKL-I-32-4	DGN / GRP - 4	125,00 €
 <p>COMPATIBLE WITH SVDK INSERT KOMPATIBEL FÜR SVDK WENDESCHNEIDPLATTEN</p>	AKL-123-32-2	123 - 2	125,00 €
	AKL-123-32-3	123 - 3	125,00 €
	AKL-123-32-4	123 - 4	125,00 €



BLADES FOR PARTING AND DEEP GROOVING / Stechschwert zur Außenbearbeitung		CUTTING INSERT WENDE PLATTE	PRICE / PREIS
 <p>COMPATIBLE WITH TGTC INSERT KOMPATIBEL FÜR TGTC WENDESCHNEIDPLATTEN</p>	AKL-TD-32-2	TD. - 2	125,00 €
	<small>NEW</small> AKL-TD-26-3	TD. - 3	117,00 €
	AKL-TD-32-3	TD. - 3	125,00 €
	AKL-TD-26-4	TD. - 4	117,00 €
	AKL-TD-32-5	TD. - 5	125,00 €
 <p>COMPATIBLE WITH ZCC INSERT KOMPATIBEL FÜR ZCC WENDESCHNEIDPLATTEN</p>	AKL-ZCC2-32-3	Z.FD-3	125,00 €
	AKL-ZCC2-32-4	Z.FD-4	125,00 €
	AKL-ZCC2-32-5	Z.FD-5	125,00 €
 <p>COMPATIBLE WITH KRLY INSERT KOMPATIBEL FÜR KRLY WENDESCHNEIDPLATTEN</p>	AKL-K-32-2	MGM.-2	125,00 €
	AKL-K-32-3	MGM.-3	125,00 €
	AKL-K-32-4	MGM.-4	125,00 €
 <p>COMPATIBLE WITH KRLY INSERT KOMPATIBEL FÜR KRLY WENDESCHNEIDPLATTEN</p>	AKL-SP-26-2	SP200N	117,00 €
	AKL-SP-26-3	SP300N	117,00 €
	AKL-SP-32-3	SP300N	125,00 €
	AKL-SP-32-4	SP400N	125,00 €
 <p>COMPATIBLE WITH WLTR INSERT KOMPATIBEL FÜR WLTR WENDESCHNEIDPLATTEN</p>	AKL-SX-32-3	SX-3E.300N	125,00 €
	AKL-SX-32-4	SX-4E.400N	125,00 €
	AKL-SX-32-5	SX-5E.500N	125,00 €
	AKL-SX-32-6	SX-5E.600N	125,00 €

BLOCKS FOR PARTING AND DEEP GROOVING BLADES / Spannblock für Stechschwert		PRICE / PREIS
	ALBU-20-26	108,00 €
	ALBU-20-32	108,00 €
	ALBU-25-26	120,00 €
	ALBU-25-32	120,00 €
	ALBU-32-32	131,00 €
	ALBU-20-32-H	188,00 €
	ALBU-25-32-H	210,00 €
	ALBU-32-32-H	229,00 €

EXTERNAL GROOVING TOOLHOLDERS WITH COOLANT TOOLS EXTERNE NUTWERKZEUGHALTER MIT KÜHLWERKZEUG		CUTTING INSERT WENDE PLATTE	PRICE / PREIS
 <p>COMPATIBLE WITH KRLY INSERT KOMPATIBEL FÜR KRLY WENDESCHNEIDPLATTEN</p>	ADKT-K-R/L-2020-3-T20-H	MGM. - 3	180,00 €
	ADKT-K-R/L-2525-3-T22-H	MGM. - 3	182,00 €
	ADKT-K-R/L-2020-4-T20-H	MGM. - 4	180,00 €
	ADKT-K-R/L-2525-4-T22-H	MGM. - 4	182,00 €
	ADKT-K-R/L-2525-5-T25-H	MGM. - 5	182,00 €
 <p>COMPATIBLE WITH TGTC INSERT KOMPATIBEL FÜR TGTC WENDESCHNEIDPLATTEN</p>	ADKT-TD-R/L-2020-3-T30-H	TD. - 3	187,00 €

INTERNAL GROOVING TOOLHOLDERS / INNEN- STECHHALTER		CUTTING INSERT WENDE PLATTE	PRICE / PREIS
 <p>COMPATIBLE WITH KRLY - JD INSERT KOMPATIBEL FÜR KRLY - JD WENDESCHNEIDPLATTEN</p>	AIKT-K-R/L-16-2-T4	MGM. - 2	73,00 €
	AIKT-K-R/L-20-2-T4	MGM. - 2	79,00 €
	AIKT-K-R/L-25-2-T6	MGM. - 2	85,00 €
	AIKT-K-R/L-20-3-T6	MGM. - 3	79,00 €
	AIKT-K-R/L-20-3-T7	MGM. - 3	84,00 €
	AIKT-K-R/L-25-3-T6	MGM. - 3	85,00 €
	AIKT-K-R/L-25-3-T10	MGM. - 3	94,00 €
	AIKT-K-R/L-32-3-T6	MGM. - 3	100,00 €
	AIKT-K-R/L-32-3-T12	MGM. - 3	108,00 €
	AIKT-K-R/L-40-3-T6	MGM. - 3	120,00 €
	AIKT-K-R/L-40-3-T12	MGM. - 3	131,00 €
	AIKT-K-R/L-20-4-T6	MGM. - 4	79,00 €
	AIKT-K-R/L-20-4-T7	MGM. - 4	84,00 €
	AIKT-K-R/L-25-4-T6	MGM. - 4	85,00 €
	AIKT-K-R/L-25-4-T10	MGM. - 4	94,00 €
	AIKT-K-R/L-32-4-T6	MGM. - 4	100,00 €
	AIKT-K-R/L-32-4-T12	MGM. - 4	108,00 €
	AIKT-K-R/L-40-4-T6	MGM. - 4	120,00 €
	AIKT-K-R/L-40-4-T12	MGM. - 4	131,00 €
	 <p>COMPATIBLE WITH KRLY INSERT KOMPATIBEL FÜR KRLY WENDESCHNEIDPLATTEN</p>	AIKT-K-R/L-25-5-T7	MGM. - 5
AIKT-K-R/L-32-5-T7		MGM. - 5	100,00 €
AIKT-K-R/L-40-5-T7		MGM. - 5	120,00 €
AIKT-K-R/L-40-5-T12		MGM. - 5	131,00 €
AIKT-KG-R/L-25-2-T7		KG.. - 2	94,00 €
AIKT-KG-R/L-20-3-T6.5-H		KG.. - 3	104,00 €
AIKT-KG-R/L-25-3-T7	KG.. - 3	94,00 €	
AIKT-KG-R/L-40-3-T8	KG.. - 3	131,00 €	
AIKT-KG-R/L-25-4-T8	KG.. - 4	94,00 €	

INTERNAL GROOVING TOOLHOLDERS / INNEN- STECHHALTER		CUTTING INSERT WENDE PLATTE	PRICE / PREIS
 <p>COMPATIBLE WITH HRN INSERT KOMPATIBEL FÜR HRN WENDESCHNEIDPLATTEN</p>	AIKT-H-R/L-25-3-T8	S229 - 3	85,00 €
	AIKT-H-R/L-32-3-T7	S229 - 3	100,00 €
	AIKT-H-R/L-40-3-T7	S229 - 3	120,00 €
	AIKT-H-R/L-25-4-T8	S229 - 4	85,00 €
	AIKT-H-R/L-32-4-T7	S229 - 4	100,00 €
	AIKT-H-R/L-40-4-T7	S229 - 4	120,00 €
	AIKT-H-R/L-25-5-T8	S229 - 5	85,00 €
	AIKT-H-R/L-32-5-T7	S229 - 5	100,00 €
AIKT-H-R/L-40-5-T7	S229 - 5	120,00 €	
 <p>COMPATIBLE WITH HRN INSERT KOMPATIBEL FÜR HRN WENDESCHNEIDPLATTEN</p>	AIKT-HK-R/L-20-2-T6	S224 - 2	79,00 €
	AIKT-HK-R/L-25-2-T6	S224 - 2	85,00 €
	AIKT-HK-R/L-20-3-T6	S224 - 3	79,00 €
	AIKT-HK-R/L-25-3-T6	S224 - 3	85,00 €
	AIKT-HK-R/L-32-3-T6	S224 - 3	100,00 €
	AIKT-HK-R/L-20-4-T6	S224 - 4	79,00 €
	AIKT-HK-R/L-25-4-T6	S224 - 4	85,00 €
	AIKT-HK-R/L-32-4-T6	S224 - 4	100,00 €
	AIKT-HS223-R/L-20-2-T5	S223 - 2	79,00 €
	AIKT-HS223-R/L-25-2-T5	S223 - 2	85,00 €
AIKT-HS223-R/L-20-3-T6	S223 - 3	79,00 €	
AIKT-HS223-R/L-25-3-T6	S223 - 3	85,00 €	
 <p>COMPATIBLE WITH SNDVK INSERT KOMPATIBEL FÜR SNDVK WENDESCHNEIDPLATTEN</p>	AIKT-154.91-R/L-16-3-T3	154.91 - 3	73,00 €
	AIKT-154.91-R/L-20-3-T4	154.91 - 3	79,00 €
	AIKT-154.91-R/L-25-3-T4	154.91 - 3	85,00 €
	AIKT-154.91-R/L-25-5-T5	154.91 - 5	85,00 €
	AIKT-154.91-R/L-32-5-T5	154.91 - 5	100,00 €
 <p>COMPATIBLE WITH ZCC INSERT KOMPATIBEL FÜR ZCC WENDESCHNEIDPLATTEN</p>	AIKT-ZCC2-R/L-16-2-T4	Z.BD - 2	73,00 €
	AIKT-ZCC2-R/L-20-3-T5	Z.FD - 3	79,00 €
	AIKT-ZCC2-R/L-20-3-T8	Z.FD - 3	84,00 €
	AIKT-ZCC2-R/L-25-3-T5	Z.FD - 3	85,00 €
	AIKT-ZCC2-R/L-25-3-T10	Z.FD - 3	94,00 €
	AIKT-ZCC2-R/L-32-3-T6	Z.FD - 3	100,00 €
	AIKT-ZCC2-R/L-32-3-T8	Z.FD - 3	113,00 €
	AIKT-ZCC2-R/L-32-3-T13	Z.FD - 3	124,00 €
	AIKT-ZCC2-R/L-40-3-T12	Z.FD - 3	131,00 €
	AIKT-ZCC2-R/L-25-4-T6	Z.GD - 4	85,00 €
	AIKT-ZCC2-R/L-32-4-T7	Z.GD - 4	100,00 €
	AIKT-ZCC2-R/L-32-4-T8	Z.GD - 4	113,00 €
	AIKT-ZCC2-R/L-32-4-T10	Z.GD - 4	113,00 €
	AIKT-ZCC2-R/L-32-5-T7	Z.HD - 5	100,00 €
	AIKT-ZCC2-R/L-32-5-T8	Z.HD - 5	113,00 €
	AIKT-ZCC2-R/L-40-5-T8	Z.HD - 5	120,00 €
	AIKT-ZCC2-R/L-40-5-T10	Z.HD - 5	131,00 €

INTERNAL GROOVING TOOLHOLDERS / INNEN- STECHHALTER		CUTTING INSERT WENDE PLATTE	PRICE / PREIS
 <p>COMPATIBLE WITH ISCR INSERT KOMPATIBEL FÜR ISCR WENDESCHNEIDPLATTEN</p>	AIKT-IGE-R/L-10-2-T3-H	GEPI - 2	87,00 €
	AIKT-IGE-R/L-16-2-T3-D11.5	GEPI - 2	96,00 €
	AIKT-IGE-R/L-16-2-T3-D11.5-H	GEPI - 2	96,00 €
	AIKT-IGE-R/L-16-2-T2.5-H	GEPI - 2	96,00 €
	AIKT-IGE-R/L-16-3-T2.5-H	GEPI - 3	96,00 €
	AIKT-IGE-R/L-16-3-T2.5-D20	GEPI - 3	87,00 €
 <p>COMPATIBLE WITH KNMTL INSERT KOMPATIBEL FÜR KNMTL WENDESCHNEIDPLATTEN</p>	AIKT-KM-R/L-20-2-T7	A4. - 2	79,00 €
	AIKT-KM-R/L-20-3-T7	A4. - 3	79,00 €
	AIKT-KM-R/L-25-3-T10	A4. - 3	85,00 €
	AIKT-KM-R/L-32-3-T12	A4. - 3	100,00 €
	AIKT-KM-R/L-40-3-T12	A4. - 3	120,00 €
	AIKT-KM-R/L-20-4-T7	A4. - 4	79,00 €
	AIKT-KM-R/L-32-4-T12.2-H	A4. - 4	120,00 €
 <p>COMPATIBLE WITH TGTC INSERT KOMPATIBEL FÜR TGTC WENDESCHNEIDPLATTEN</p>	AIKT-RD-R/L-16-2-T6	RD. - 2	78,00 €
	AIKT-RD-R/L-20-2-T6	RD. - 2	86,00 €
	AIKT-RD-R/L-25-2-T6	RD. - 2	94,00 €
	AIKT-RD-R/L-16-3-T6	RD. - 3	78,00 €
	AIKT-RD-R/L-20-3-T6	RD. - 3	86,00 €
	AIKT-RD-R/L-25-3-T6	RD. - 3	94,00 €
	AIKT-RD-R/L-32-3-T6	RD. - 3	113,00 €
	AIKT-RD-R/L-20-4-T6	RD. - 4	86,00 €
	AIKT-RD-R/L-25-4-T6	RD. - 4	94,00 €
AIKT-RD-R/L-32-4-T6	RD. - 4	113,00 €	
 <p>COMPATIBLE WITH TGTC INSERT KOMPATIBEL FÜR TGTC WENDESCHNEIDPLATTEN</p>	AIKT-TD-R/L-16-2-T8.5-H	TD. - 2	96,00 €
	AIKT-TD-R/L-20-3-T6-H	TD. - 3	105,00 €
	AIKT-TD-R/L-25-3-T6-H	TD. - 3	115,00 €
	AIKT-TD-R/L-32-3-T5-H	TD. - 3	139,00 €
	NEW AIKT-TD-R/L-20-4-T10-H	TD. - 4	126,00 €
	NEW AIKT-TD-R/L-25-4-T10-H	TD. - 4	138,00 €
	NEW AIKT-TD-R/L-32-4-T10-H	TD. - 4	166,00 €
 <p>COMPATIBLE WITH ISCR INSERT KOMPATIBEL FÜR ISCR WENDESCHNEIDPLATTEN</p>	AIKT-ITG-R/L-16-3-T6-H	TGM. - 3	96,00 €
	AIKT-ITG-R/L-20-3-T6-H	TGM. - 3	105,00 €
	AIKT-ITG-R/L-25-3-T8-H	TGM. - 3	115,00 €
	AIKT-ITG-R/L-32-3-T8-H	TGM. - 3	139,00 €
	AIKT-ITG-R/L-20-4-T6-H	TGM. - 4	105,00 €
	AIKT-ITG-R/L-25-4-T7-H	TGM. - 4	115,00 €
	AIKT-ITG-R/L-25-4-T9-H	TGM. - 4	120,00 €
	AIKT-ITG-R/L-32-4-T11-H	TGM. - 4	139,00 €
	AIKT-ITG-R/L-40-4-T11-H	TGM. - 4	239,00 €
	AIKT-ITG-R/L-32-6.35-T17.5-H	TGM. - 6.35	188,00 €

INTERNAL GROOVING TOOLHOLDERS / INNEN- STECHHALTER		CUTTING INSERT WENDE PLATTE	PRICE / PREIS
 <p>COMPATIBLE WITH ISCR INSERT KOMPATIBEL FÜR ISCR WENDESCHNEIDPLATTEN</p>	AIKT-IG-R/L-25-4-T10-H	DGN / GRP - 4	120,00 €
	AIKT-IG-R/L-32-4-T10-H	DGN / GRP - 4	144,00 €
	AIKT-IG-R/L-40-4-T12-H	DGN / GRP - 4	239,00 €
	AIKT-IG-R/L-25-5-T10-H	DGN / GRP - 5	120,00 €
	AIKT-IG-R/L-32-5-T10-H	DGN / GRP - 5	144,00 €
	AIKT-IG-R/L-40-5-T12-H	DGN / GRP - 5	239,00 €
	AIKT-IG-R/L-50-5-T12-H	DGN / GRP - 5	299,00 €
 <p>COMPATIBLE WITH ISCR INSERT KOMPATIBEL FÜR ISCR WENDESCHNEIDPLATTEN</p>	AIKT-IGI-R/L-20-3-T4	GIMIY / GIPI - 3	105,00 €
	AIKT-IGI-R/L-25-3-T5	GIMIY / GIPI - 3	115,00 €
	AIKT-IGI-R/L-32-3-T5	GIMIY / GIPI - 3	139,00 €
	AIKT-IGI-R/L-40-3-T5	GIMIY / GIPI - 3	167,00 €
	AIKT-IGI-R/L-20-4-T4	GIMIY / GIPI - 4	105,00 €
	AIKT-IGI-R/L-25-5-T10	GIMIY / GIPI - 5	115,00 €
	AIKT-IGI-R/L-25-5-T10-H	GIMIY / GIPI - 5	138,00 €
	AIKT-IGI-R/L-25-5-T15	GIMIY / GIPI - 5	166,00 €
AIKT-IGI-R/L-25-5-T15-H	GIMIY / GIPI - 5	166,00 €	
 <p>COMPATIBLE WITH ISCR INSERT KOMPATIBEL FÜR ISCR WENDESCHNEIDPLATTEN</p>	AIKT-I-R/L-20-3-T5	DGN - 3	79,00 €
	AIKT-I-R/L-25-3-T6	DGN - 3	85,00 €
 <p>COMPATIBLE WITH PLBT INSERT KOMPATIBEL FÜR PLBT WENDESCHNEIDPLATTEN</p>	AIKT-GP-R/L-20-2-T4	GP - 2	84,00 €
	AIKT-GP-R/L-25-2-T6	GP - 2	94,00 €
	AIKT-GP-R/L-20-3-T6	GP - 3	84,00 €
	AIKT-GP-R/L-25-3-T6	GP - 3	94,00 €
	AIKT-GP-R/L-32-3-T6	GP - 3	108,00 €
	AIKT-GP-R/L-20-4-T6	GP - 4	84,00 €
	AIKT-GP-R/L-25-4-T6	GP - 4	94,00 €
	AIKT-GP-R/L-32-4-T6	GP - 4	108,00 €
 <p>COMPATIBLE WITH SMTM INSERT KOMPATIBEL FÜR SMTM WENDESCHNEIDPLATTEN</p>	AIKT-SGC-R/L-25-3-T6	GCM N30	94,00 €
	AIKT-SGC-R/L-32-3-T6	GCM N30	154,00 €
	AIKT-SGC-R/L-40-3-T6	GCM N30	179,00 €

INTERNAL GROOVING TOOLHOLDERS / INNEN- STECHHALTER		CUTTING INSERT WENDE PLATTE	PRICE / PREIS
 <p>COMPATIBLE WITH SNDVK INSERT KOMPATIBEL FÜR SNDVK WENDESCHNEIDPLATTEN</p>	AIKT-123-R/L-20-2-T6	123 - 2	79,00 €
	AIKT-123-R/L-25-2-T6	123 - 2	85,00 €
	AIKT-123-R/L-32-2-T7	123 - 2	100,00 €
	AIKT-123-R/L-20-3-T6	123 - 3	79,00 €
	AIKT-123-R/L-25-3-T7	123 - 3	85,00 €
	AIKT-123-R/L-32-3-T9	123 - 3	108,00 €
	AIKT-123-R/L-20-4-T8	123 - 4	84,00 €
	AIKT-123-R/L-25-4-T7	123 - 4	85,00 €
	AIKT-123-R/L-32-4-T7	123 - 4	100,00 €
	AIKT-123-R/L-32-4-T10	123 - 4	108,00 €
	AIKT-123-R/L-25-5-T8	123 - 5	85,00 €
AIKT-123-R/L-32-5-T11	123 - 5	108,00 €	
 <p>COMPATIBLE WITH SNDVK INSERT KOMPATIBEL FÜR SNDVK WENDESCHNEIDPLATTEN</p>	AIKT-151.23-R/L-20-2-T6	151.2 - 2	79,00 €
	AIKT-151.23-R/L-20-2.5-T6	151.2 - 2.5	79,00 €
	AIKT-151.22-R/L-25-3-T6	151.2 - 3	101,00 €
	AIKT-151.22-R/L-25-3-T6-H	151.2 - 3	101,00 €
 <p>COMPATIBLE WITH TNGLY INSERT KOMPATIBEL FÜR TNGLY WENDESCHNEIDPLATTEN</p>	AIKT-TG-R/L-20-2-T6	DGIM2 - 020	86,00 €
	AIKT-TG-R/L-20-3-T6	DTX3 - 030	86,00 €
	AIKT-TG-R/L-25-3-T8	DTX3 - 030	99,00 €
	AIKT-TG-R/L-32-3-T10	DTX3 - 030	119,00 €
	AIKT-TG-R/L-32-3-T12	DTX3 - 030	125,00 €
	AIKT-TG-R/L-32-4-T10	DTX4 - 040	119,00 €
	AIKT-TG-R/L-32-5-T10	DTX5 - 050	119,00 €
 <p>COMPATIBLE WITH ZCC INSERT KOMPATIBEL FÜR ZCC WENDESCHNEIDPLATTEN</p>	AIKT-QC11-R/L-20-(0.5-1.8)	QC11R/L (0.50-1.80)	87,00 €
	AIKT-QC16-R/L-20-(0.5-1.8)	QC16R/L (0.50-1.80)	87,00 €
	AIKT-QC16-R/L-20-(0.5-2.5)	QC16R/L (0.50-2.50)	87,00 €
	AIKT-QC22-R/L-25-(1-2.3)	QC22R/L (1.00-2.30)	93,00 €
	AIKT-QC22-R/L-25-(2.5-3.3)	QC22R/L (2.50-3.30)	93,00 €
	AIKT-QC22-R/L-25-(3.3-4.8)	QC22R/L (3.30-4.80)	93,00 €
	AIKT-QC22-R/L-32-(1-2.3)	QC22R/L (1.00-2.30)	111,00 €

MINI GROOVING TOOL / MINI - STECHWERKZEUGE		CUTTING INSERT WENDE PLATTE	PRICE / PREIS
 <p>COMPATIBLE WITH SNDVK INSERT KOMPATIBEL FÜR SNDVK WENDESCHNEIDPLATTEN</p>	AIKT-MB07-A16-090-15	MB - 07	108,00 €
	AIKT-MB07-A16-090-22	MB - 07	108,00 €
	AIKT-MB09-A16-090-19	MB - 09	108,00 €
	AIKT-MB09-A16-110-40	MB - 09	108,00 €
	AIKT-MB09-A16-095-28	MB - 09	108,00 €

U-DRILL SYSTEM / VOLLBOHRER (WCM.)

D2	CODE / TYP	TOOL DIMENSIONS (mm) <i>MAß</i>						CUTTING INSERT WENDE PLATTE	PRICE / PREIS	
		DC	DCON	DCSFMS	OAL	LU	LPR			LS
	ATUM 16XD2 WCM. 030208	16	25	34	110	32	54	56	WCM. 030208	172,00 €
	ATUM 16.5XD2 WCM. 030208	16,5	25	34	110	32	54	56	WCM. 030208	172,00 €
	ATUM 17XD2 WCM. 030208	17	25	34	112	34	56	56	WCM. 030208	172,00 €
	ATUM 17.5XD2 WCM. 030208	17,5	25	34	112	34	56	56	WCM. 030208	172,00 €
	ATUM 18XD2 WCM. 030208	18	25	34	114	36	58	56	WCM. 030208	172,00 €
	ATUM 18.5XD2 WCM. 030208	18,5	25	34	114	36	58	56	WCM. 030208	172,00 €
	ATUM 19XD2 WCM. 030208	19	25	34	116	38	60	56	WCM. 030208	172,00 €
	ATUM 19.5XD2 WCM. 030208	19,5	25	34	116	38	60	56	WCM. 030208	172,00 €
	ATUM 20XD2 WCM. 040208	20	25	34	118	40	62	56	WCM. 040208	184,00 €
	ATUM 20.5XD2 WCM. 040208	20,5	25	34	118	40	62	56	WCM. 040208	184,00 €
	ATUM 21XD2 WCM. 040208	21	25	34	120	42	64	56	WCM. 040208	184,00 €
	ATUM 21.5XD2 WCM. 040208	21,5	25	34	120	42	64	56	WCM. 040208	184,00 €
	ATUM 22XD2 WCM. 040208	22	25	34	122	44	66	56	WCM. 040208	184,00 €
	ATUM 22.5XD2 WCM. 040208	22,5	25	34	122	44	66	56	WCM. 040208	184,00 €
	ATUM 23XD2 WCM. 040208	23	25	34	124	46	68	56	WCM. 040208	184,00 €
	ATUM 23.5XD2 WCM. 040208	23,5	25	34	124	46	68	56	WCM. 040208	184,00 €
	ATUM 24XD2 WCM. 050308	24	25	34	126	48	70	56	WCM. 050308	192,00 €
	ATUM 24.5XD2 WCM. 050308	24,5	25	34	126	48	70	56	WCM. 050308	192,00 €
	ATUM 25XD2 WCM. 050308	25	25	34	128	50	72	56	WCM. 050308	192,00 €
	ATUM 25.5XD2 WCM. 050308	25,5	25	34	128	50	72	56	WCM. 050308	192,00 €
	ATUM 26XD2 WCM. 050308	26	25	34	130	52	74	56	WCM. 050308	192,00 €
	ATUM 26.5XD2 WCM. 050308	26,5	25	34	130	52	74	56	WCM. 050308	192,00 €
	ATUM 27XD2 WCM. 050308	27	25	34	132	54	76	56	WCM. 050308	192,00 €
	ATUM 27.5XD2 WCM. 050308	27,5	25	34	132	54	76	56	WCM. 050308	192,00 €
	ATUM 28XD2 WCM. 050308	28	25	34	134	56	78	56	WCM. 050308	192,00 €
	ATUM 28.5XD2 WCM. 050308	28,5	25	34	134	56	78	56	WCM. 050308	192,00 €
	ATUM 29XD2 WCM. 050308	29	25	34	136	58	80	56	WCM. 050308	192,00 €
	ATUM 29.5XD2 WCM. 050308	29,5	25	34	136	58	80	56	WCM. 050308	192,00 €
	ATUM 30XD2 WCM. 06T308	30	32	44	147	60	87	60	WCM. 06T308	204,00 €
	ATUM 31XD2 WCM. 06T308	31	32	44	149	62	89	60	WCM. 06T308	204,00 €
	ATUM 32XD2 WCM. 06T308	32	32	44	151	64	91	60	WCM. 06T308	204,00 €
	ATUM 33XD2 WCM. 06T308	33	32	44	153	66	93	60	WCM. 06T308	204,00 €
	ATUM 34XD2 WCM. 06T308	34	32	44	155	68	95	60	WCM. 06T308	204,00 €
	ATUM 35XD2 WCM. 06T308	35	32	44	157	70	97	60	WCM. 06T308	204,00 €
	ATUM 36XD2 WCM. 06T308	36	32	44	159	72	99	60	WCM. 06T308	204,00 €
	ATUM 37XD2 WCM. 06T308	37	32	44	161	74	101	60	WCM. 06T308	204,00 €
	ATUM 38XD2 WCM. 06T308	38	32	44	163	76	103	60	WCM. 06T308	204,00 €
	ATUM 39XD2 WCM. 06T308	39	32	44	165	78	105	60	WCM. 06T308	204,00 €
	ATUM 40XD2 WCM. 06T308	40	32	44	167	80	107	60	WCM. 06T308	204,00 €
	ATUM 41XD2 WCM. 06T308	41	32	44	169	82	109	60	WCM. 06T308	211,00 €
	ATUM 42XD2 WCM. 06T308	42	32	44	171	84	111	60	WCM. 06T308	211,00 €
	ATUM 43XD2 WCM. 06T308	43	32	44	173	86	113	60	WCM. 06T308	211,00 €
	ATUM 44XD2 WCM. 06T308	44	32	44	175	88	115	60	WCM. 06T308	211,00 €
	ATUM 45XD2 WCM. 080412	45	40	54	192	90	122	70	WCM. 080412	231,00 €
	ATUM 46XD2 WCM. 080412	46	40	54	194	92	124	70	WCM. 080412	243,00 €
	ATUM 47XD2 WCM. 080412	47	40	54	196	94	126	70	WCM. 080412	263,00 €
	ATUM 48XD2 WCM. 080412	48	40	54	198	96	128	70	WCM. 080412	277,00 €
	ATUM 49XD2 WCM. 080412	49	40	54	200	98	130	70	WCM. 080412	290,00 €
	ATUM 50XD2 WCM. 080412	50	40	54	202	100	132	70	WCM. 080412	303,00 €
	ATUM 51XD2 WCM. 080412	51	40	54	204	102	134	70	WCM. 080412	316,00 €
	ATUM 52XD2 WCM. 080412	52	40	54	206	104	136	70	WCM. 080412	330,00 €
	ATUM 53XD2 WCM. 080412	53	40	54	208	106	138	70	WCM. 080412	343,00 €
	ATUM 54XD2 WCM. 080412	54	40	54	210	108	140	70	WCM. 080412	356,00 €
	ATUM 55XD2 WCM. 080412	55	40	54	212	110	142	70	WCM. 080412	356,00 €
	ATUM 56XD2 WCM. 080412	56	40	59	214	112	144	70	WCM. 080412	356,00 €
	ATUM 57XD2 WCM. 080412	57	40	59	216	114	146	70	WCM. 080412	382,00 €
	ATUM 58XD2 WCM. 080412	58	40	59	218	116	148	70	WCM. 080412	382,00 €
	ATUM 59XD2 WCM. 080412	59	40	59	220	118	150	70	WCM. 080412	382,00 €
	ATUM 60XD2 WCM. 080412	60	40	59	222	120	152	70	WCM. 080412	382,00 €

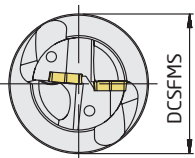
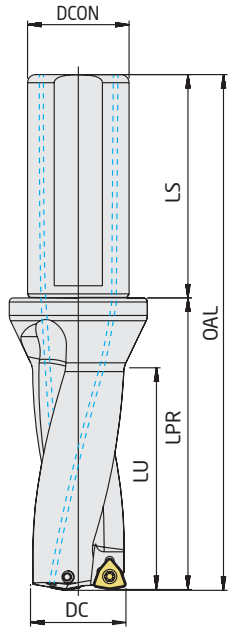

COMPATIBLE WITH ISO INSERT
KOMPATIBEL FÜR ISO WENDESCHNEIDPLATTEN

U-DRILL SYSTEM / VOLLBOHRER (WCM.)

D3	CODE / TYP	TOOL DIMENSIONS (mm) <i>MAß</i>							CUTTING INSERT WENDE PLATTE	PRICE / PREIS
		DC	DCON	DCSFMS	OAL	LU	LPR	LS		
	ATUM 16XD3 WCM. 030208	16	25	34	126	48	70	56	WCM. 030208	184,00 €
	ATUM 16.5XD3 WCM. 030208	16.5	25	34	126	48	70	56	WCM. 030208	184,00 €
	ATUM 17XD3 WCM. 030208	17	25	34	129	51	73	56	WCM. 030208	184,00 €
	ATUM 17.5XD3 WCM. 030208	17.5	25	34	129	51	73	56	WCM. 030208	184,00 €
	ATUM 18XD3 WCM. 030208	18	25	34	132	54	76	56	WCM. 030208	184,00 €
	ATUM 18.5XD3 WCM. 030208	18.5	25	34	132	54	76	56	WCM. 030208	184,00 €
	ATUM 19XD3 WCM. 030208	19	25	34	135	57	79	56	WCM. 030208	184,00 €
	ATUM 19.5XD3 WCM. 030208	19.5	25	34	135	57	79	56	WCM. 030208	184,00 €
	ATUM 20XD3 WCM. 040208	20	25	34	138	60	82	56	WCM. 040208	192,00 €
	ATUM 20.5XD3 WCM. 040208	20.5	25	34	138	60	82	56	WCM. 040208	192,00 €
	ATUM 21XD3 WCM. 040208	21	25	34	141	63	85	56	WCM. 040208	192,00 €
	ATUM 21.5XD3 WCM. 040208	21.5	25	34	141	63	85	56	WCM. 040208	192,00 €
	ATUM 22XD3 WCM. 040208	22	25	34	144	66	88	56	WCM. 040208	192,00 €
	ATUM 22.5XD3 WCM. 040208	22.5	25	34	144	66	88	56	WCM. 040208	192,00 €
	ATUM 23XD3 WCM. 040208	23	25	34	147	69	91	56	WCM. 040208	192,00 €
	ATUM 23.5XD3 WCM. 040208	23.5	25	34	147	69	91	56	WCM. 040208	192,00 €
	ATUM 24XD3 WCM. 050308	24	25	34	150	72	94	56	WCM. 050308	198,00 €
	ATUM 24.5XD3 WCM. 050308	24.5	25	34	150	72	94	56	WCM. 050308	198,00 €
	ATUM 25XD3 WCM. 050308	25	25	34	153	75	97	56	WCM. 050308	198,00 €
	ATUM 25.5XD3 WCM. 050308	25.5	25	34	153	75	97	56	WCM. 050308	198,00 €
	ATUM 26XD3 WCM. 050308	26	25	34	156	78	100	56	WCM. 050308	198,00 €
	ATUM 26.5XD3 WCM. 050308	26.5	25	34	156	78	100	56	WCM. 050308	198,00 €
	ATUM 27XD3 WCM. 050308	27	25	34	159	81	103	56	WCM. 050308	198,00 €
	ATUM 27.5XD3 WCM. 050308	27.5	25	34	159	81	103	56	WCM. 050308	198,00 €
	ATUM 28XD3 WCM. 050308	28	25	34	162	84	106	56	WCM. 050308	198,00 €
	ATUM 28.5XD3 WCM. 050308	28.5	25	34	162	84	106	56	WCM. 050308	198,00 €
	ATUM 29XD3 WCM. 050308	29	25	34	165	87	109	56	WCM. 050308	198,00 €
	ATUM 29.5XD3 WCM. 050308	29.5	25	34	165	87	109	56	WCM. 050308	198,00 €
	ATUM 30XD3 WCM. 06T308	30	32	44	177	90	117	60	WCM. 06T308	204,00 €
	ATUM 30.5XD3 WCM. 06T308	30.5	32	44	177	90	117	60	WCM. 06T308	204,00 €
	ATUM 31XD3 WCM. 06T308	31	32	44	180	93	120	60	WCM. 06T308	204,00 €
	ATUM 31.5XD3 WCM. 06T308	31.5	32	44	180	93	120	60	WCM. 06T308	204,00 €
	ATUM 32XD3 WCM. 06T308	32	32	44	183	96	123	60	WCM. 06T308	204,00 €
	ATUM 32.5XD3 WCM. 06T308	32.5	32	44	183	96	123	60	WCM. 06T308	204,00 €
	ATUM 33XD3 WCM. 06T308	33	32	44	186	99	126	60	WCM. 06T308	204,00 €
	ATUM 33.5XD3 WCM. 06T308	33.5	32	44	186	99	126	60	WCM. 06T308	204,00 €
	ATUM 34XD3 WCM. 06T308	34	32	44	189	102	129	60	WCM. 06T308	204,00 €
	ATUM 34.5XD3 WCM. 06T308	34.5	32	44	189	102	129	60	WCM. 06T308	204,00 €
	ATUM 35XD3 WCM. 06T308	35	32	44	192	105	132	60	WCM. 06T308	204,00 €
	ATUM 35.5XD3 WCM. 06T308	35.5	32	44	192	105	132	60	WCM. 06T308	204,00 €
	ATUM 36XD3 WCM. 06T308	36	32	44	195	108	135	60	WCM. 06T308	204,00 €
	ATUM 36.5XD3 WCM. 06T308	36.5	32	44	195	108	135	60	WCM. 06T308	204,00 €
	ATUM 37XD3 WCM. 06T308	37	32	44	198	111	138	60	WCM. 06T308	204,00 €
	ATUM 37.5XD3 WCM. 06T308	37.5	32	44	198	111	138	60	WCM. 06T308	204,00 €
	ATUM 38XD3 WCM. 06T308	38	32	44	201	114	141	60	WCM. 06T308	204,00 €
	ATUM 38.5XD3 WCM. 06T308	38.5	32	44	201	114	141	60	WCM. 06T308	204,00 €
	ATUM 39XD3 WCM. 06T308	39	32	44	204	117	144	60	WCM. 06T308	204,00 €
	ATUM 39.5XD3 WCM. 06T308	39.5	32	44	204	117	144	60	WCM. 06T308	204,00 €
	ATUM 40XD3 WCM. 06T308	40	32	44	207	120	147	60	WCM. 06T308	204,00 €
	ATUM 40.5XD3 WCM. 06T308	40.5	32	44	207	120	147	60	WCM. 06T308	204,00 €
	ATUM 41XD3 WCM. 06T308	41	32	44	210	123	150	60	WCM. 06T308	225,00 €
	ATUM 41.5XD3 WCM. 06T308	41.5	32	44	210	123	150	60	WCM. 06T308	225,00 €
	ATUM 42XD3 WCM. 06T308	42	32	44	213	126	153	60	WCM. 06T308	225,00 €
	ATUM 42.5XD3 WCM. 06T308	42.5	32	44	213	126	153	60	WCM. 06T308	225,00 €
	ATUM 43XD3 WCM. 06T308	43	32	44	216	129	156	60	WCM. 06T308	225,00 €
	ATUM 43.5XD3 WCM. 06T308	43.5	32	44	216	129	156	60	WCM. 06T308	225,00 €
	ATUM 44XD3 WCM. 06T308	44	32	44	219	132	159	60	WCM. 06T308	225,00 €
	ATUM 44.5XD3 WCM. 06T308	44.5	32	44	219	132	159	60	WCM. 06T308	225,00 €

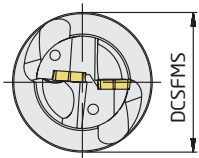
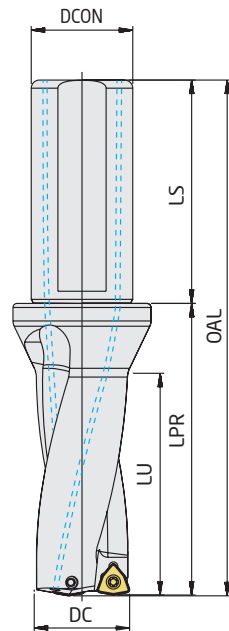

COMPATIBLE WITH ISO INSERT
KOMPATIBEL FÜR ISO WENDESCHNEIDPLATTEN

U-DRILL SYSTEM / VOLLBOHRER (WCM.)

	CODE / TYP	TOOL DIMENSIONS (mm) <i>MAß</i>							CUTTING INSERT WENDE PLATTE	PRICE / PREIS
		DC	DCON	DCS _{FMS}	OAL	LU	LPR	LS		
D3  COMPATIBLE WITH ISO INSERT KOMPATIBEL FÜR ISO WENDESCHNEIDPLATTEN	ATUM 45XD3 WCM. 080412	45	40	54	237	135	167	70	WCM. 080412	237,00 €
	ATUM 45.5XD3 WCM. 080412	45.5	40	54	237	135	167	70	WCM. 080412	237,00 €
	ATUM 46XD3 WCM. 080412	46	40	54	240	138	170	70	WCM. 080412	251,00 €
	ATUM 47XD3 WCM. 080412	47	40	54	243	141	173	70	WCM. 080412	263,00 €
	ATUM 48XD3 WCM. 080412	48	40	54	246	144	176	70	WCM. 080412	277,00 €
	ATUM 49XD3 WCM. 080412	49	40	54	249	147	179	70	WCM. 080412	290,00 €
	ATUM 50XD3 WCM. 080412	50	40	54	252	150	182	70	WCM. 080412	316,00 €
	ATUM 51XD3 WCM. 080412	51	40	54	255	153	185	70	WCM. 080412	330,00 €
	ATUM 52XD3 WCM. 080412	52	40	54	258	156	188	70	WCM. 080412	343,00 €
	ATUM 53XD3 WCM. 080412	53	40	54	261	159	191	70	WCM. 080412	356,00 €
	ATUM 54XD3 WCM. 080412	54	40	54	264	162	194	70	WCM. 080412	369,00 €
	ATUM 55XD3 WCM. 080412	55	40	54	267	165	197	70	WCM. 080412	369,00 €
	ATUM 56XD3 WCM. 080412	56	40	59	270	168	200	70	WCM. 080412	369,00 €
	ATUM 57XD3 WCM. 080412	57	40	59	273	171	203	70	WCM. 080412	396,00 €
	ATUM 58XD3 WCM. 080412	58	40	59	276	174	206	70	WCM. 080412	396,00 €
	ATUM 59XD3 WCM. 080412	59	40	59	279	177	209	70	WCM. 080412	396,00 €
ATUM 60XD3 WCM. 080412	60	40	59	282	180	212	70	WCM. 080412	396,00 €	

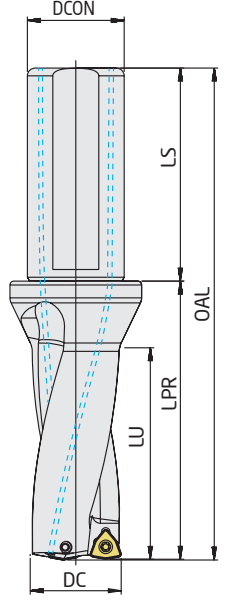
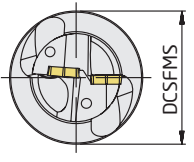
	CODE / TYP	TOOL DIMENSIONS (mm) <i>MAß</i>							CUTTING INSERT WENDE PLATTE	PRICE / PREIS
		DC	DCON	DCS _{FMS}	OAL	LU	LPR	LS		
D5    COMPATIBLE WITH ISO INSERT KOMPATIBEL FÜR ISO WENDESCHNEIDPLATTEN	ATUM 20XD5 WCM. 040208	20	25	34	178	100	122	56	WCM. 040208	286.00 €
	ATUM 21XD5 WCM. 040208	21	25	34	183	105	127	56	WCM. 040208	286.00 €
	ATUM 22XD5 WCM. 040208	22	25	34	188	110	132	56	WCM. 040208	286.00 €
	ATUM 23XD5 WCM. 040208	23	25	34	193	115	137	56	WCM. 040208	286.00 €
	ATUM 24XD5 WCM. 050308	24	25	34	198	120	142	56	WCM. 050308	297.00 €
	ATUM 25XD5 WCM. 050308	25	25	34	203	125	147	56	WCM. 050308	297.00 €
	ATUM 26XD5 WCM. 050308	26	25	34	208	130	152	56	WCM. 050308	297.00 €
	ATUM 27XD5 WCM. 050308	27	25	34	213	135	157	56	WCM. 050308	297.00 €
	ATUM 28XD5 WCM. 050308	28	25	34	218	140	162	56	WCM. 050308	297.00 €
	ATUM 29XD5 WCM. 050308	29	25	34	223	145	167	56	WCM. 050308	297.00 €
	ATUM 30XD5 WCM. 06T308	30	32	44	237	150	177	60	WCM. 06T308	306.00 €
	ATUM 31XD5 WCM. 06T308	31	32	44	242	155	182	60	WCM. 06T308	306.00 €
	ATUM 32XD5 WCM. 06T308	32	32	44	247	160	187	60	WCM. 06T308	306.00 €
	ATUM 33XD5 WCM. 06T308	33	32	44	252	165	192	60	WCM. 06T308	306.00 €
	ATUM 34XD5 WCM. 06T308	34	32	44	257	170	197	60	WCM. 06T308	306.00 €
	ATUM 35XD5 WCM. 06T308	35	32	44	262	175	202	60	WCM. 06T308	306.00 €
	ATUM 37XD5 WCM. 06T308	37	32	44	272	185	212	60	WCM. 06T308	306.00 €
	ATUM 38XD5 WCM. 06T308	38	32	44	277	190	217	60	WCM. 06T308	306.00 €
	ATUM 46XD5 WCM. 080412	46	40	54	332	230	262	70	WCM. 080412	395.00 €

U-DRILL SYSTEM / VOLLBOHRER (WCM.)

D4	CODE / TYP	TOOL DIMENSIONS (mm) <i>MAB</i>						CUTTING INSERT WENDE PLATTE	PRICE / PREIS	
		DC	DCON	DCSFMS	OAL	LU	LPR			LS
	ATUM 16XD4 WCM. 030208	16	25	34	142	64	86	56	WCM. 030208	280,00 €
	ATUM 16.5XD4 WCM. 030208	16.5	25	34	142	64	86	56	WCM. 030208	280,00 €
	ATUM 17XD4 WCM. 030208	17	25	34	146	68	90	56	WCM. 030208	280,00 €
	ATUM 17.5XD4 WCM. 030208	17.5	25	34	146	68	90	56	WCM. 030208	280,00 €
	ATUM 18XD4 WCM. 030208	18	25	34	150	72	94	56	WCM. 030208	280,00 €
	ATUM 18.5XD4 WCM. 030208	18.5	25	34	150	72	94	56	WCM. 040208	280,00 €
	ATUM 19XD4 WCM. 030208	19	25	34	154	76	98	56	WCM. 030208	280,00 €
	ATUM 19.5XD4 WCM. 030208	19.5	25	34	154	76	98	56	WCM. 030208	280,00 €
	ATUM 20XD4 WCM. 040208	20	25	34	158	80	102	56	WCM. 040208	292,00 €
	ATUM 20.5XD4 WCM. 040208	20.5	25	34	158	80	102	56	WCM. 040208	292,00 €
	ATUM 21XD4 WCM. 040208	21	25	34	162	84	106	56	WCM. 040208	292,00 €
	ATUM 21.5XD4 WCM. 040208	21.5	25	34	162	84	106	56	WCM. 040208	292,00 €
	ATUM 22XD4 WCM. 040208	22	25	34	166	88	110	56	WCM. 040208	292,00 €
	ATUM 22.5XD4 WCM. 040208	22.5	25	34	166	88	110	56	WCM. 040208	292,00 €
	ATUM 23XD4 WCM. 040208	23	25	34	170	92	114	56	WCM. 040208	292,00 €
	ATUM 23.5XD4 WCM. 040208	23.5	25	34	170	92	114	56	WCM. 040208	292,00 €
	ATUM 24XD4 WCM. 050308	24	25	34	174	96	118	56	WCM. 050308	305,00 €
	ATUM 24.5XD4 WCM. 050308	24.5	25	34	174	96	118	56	WCM. 050308	305,00 €
	ATUM 25XD4 WCM. 050308	25	25	34	178	100	122	56	WCM. 050308	305,00 €
	ATUM 25.5XD4 WCM. 050308	25.5	25	34	178	100	122	56	WCM. 050308	305,00 €
	ATUM 26XD4 WCM. 050308	26	25	34	182	104	126	56	WCM. 050308	305,00 €
	ATUM 26.5XD4 WCM. 050308	26.5	25	34	182	104	126	56	WCM. 050308	305,00 €
	ATUM 27XD4 WCM. 050308	27	25	34	186	108	130	56	WCM. 050308	305,00 €
	ATUM 27.5XD4 WCM. 050308	27.5	25	34	186	108	130	56	WCM. 050308	305,00 €
	ATUM 28XD4 WCM. 050308	28	25	34	190	112	134	56	WCM. 050308	305,00 €
	ATUM 28.5XD4 WCM. 050308	28.5	25	34	190	112	134	56	WCM. 050308	305,00 €
	ATUM 29XD4 WCM. 050308	29	25	34	194	116	138	56	WCM. 050308	305,00 €
	ATUM 29.5XD4 WCM. 050308	29.5	25	34	194	116	138	56	WCM. 050308	305,00 €
	ATUM 30XD4 WCM. 06T308	30	32	44	207	120	147	60	WCM. 06T308	317,00 €
	ATUM 31XD4 WCM. 06T308	31	32	44	211	124	151	60	WCM. 06T308	317,00 €
	ATUM 32XD4 WCM. 06T308	32	32	44	215	128	155	60	WCM. 06T308	317,00 €
	ATUM 33XD4 WCM. 06T308	33	32	44	219	132	159	60	WCM. 06T308	317,00 €
	ATUM 33.5XD4 WCM. 06T308	33.5	32	44	219	132	159	60	WCM. 06T308	317,00 €
	ATUM 34XD4 WCM. 06T308	34	32	44	223	136	163	60	WCM. 06T308	317,00 €
	ATUM 35XD4 WCM. 06T308	35	32	44	227	140	167	60	WCM. 06T308	317,00 €
	ATUM 36XD4 WCM. 06T308	36	32	44	231	144	171	60	WCM. 06T308	317,00 €
	ATUM 37XD4 WCM. 06T308	37	32	44	235	148	175	60	WCM. 06T308	317,00 €
	ATUM 38XD4 WCM. 06T308	38	32	44	239	152	179	60	WCM. 06T308	317,00 €
	ATUM 38.5XD4 WCM. 06T308	38.5	32	44	239	152	179	60	WCM. 06T308	317,00 €
	ATUM 39XD4 WCM. 06T308	39	32	44	243	156	183	60	WCM. 06T308	317,00 €
	ATUM 40XD4 WCM. 06T308	40	32	44	247	160	187	60	WCM. 06T308	317,00 €
	ATUM 41XD4 WCM. 06T308	41	32	44	251	164	191	60	WCM. 06T308	341,00 €
	ATUM 42XD4 WCM. 06T308	42	32	44	255	168	195	60	WCM. 06T308	341,00 €
	ATUM 43XD4 WCM. 06T308	43	32	44	259	172	199	60	WCM. 06T308	341,00 €
	ATUM 44XD4 WCM. 06T308	44	32	44	263	176	203	60	WCM. 06T308	341,00 €
	ATUM 45XD4 WCM. 080412	45	40	54	282	180	212	70	WCM. 080412	366,00 €
	ATUM 46XD4 WCM. 080412	46	40	54	286	184	216	70	WCM. 080412	389,00 €
	ATUM 47XD4 WCM. 080412	47	40	54	290	188	220	70	WCM. 080412	414,00 €
	ATUM 48XD4 WCM. 080412	48	40	54	294	192	224	70	WCM. 080412	438,00 €
	ATUM 49XD4 WCM. 080412	49	40	54	298	196	228	70	WCM. 080412	462,00 €
	ATUM 50XD4 WCM. 080412	50	40	54	302	200	232	70	WCM. 080412	486,00 €

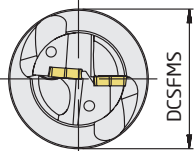
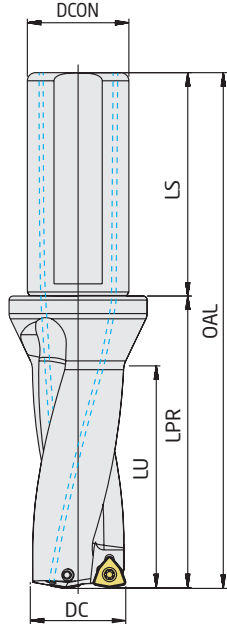

COMPATIBLE WITH ISO INSERT
KOMPATIBEL FÜR ISO WENDESCHNEIDPLATTEN

U-DRILL SYSTEM / VOLLBOHRER (SPMG.)

D2	CODE / TYP	TOOL DIMENSIONS (mm) MAB						CUTTING INSERT WENDE PLATTE	PRICE / PREIS	
		DC	DCON	DCSFMS	OAL	LU	LPR			LS
	ATUM 12.5XD2 SP.. 050204	12.5	20	25	96	24	46	50	SP.. 050204	172,00 €
	ATUM 13XD2 SP.. 050204	13	20	25	98	26	48	50	SP.. 050204	172,00 €
	ATUM 13.5XD2 SP.. 050204	13.5	20	25	98	26	48	50	SP.. 050204	172,00 €
	ATUM 14XD2 SP.. 050204	14	20	25	100	28	50	50	SP.. 050204	172,00 €
	ATUM 14.5XD2 SP.. 050204	14.5	20	25	100	28	50	50	SP.. 050204	172,00 €
	ATUM 15XD2 SP.. 050204	15	20	25	102	30	52	50	SP.. 050204	172,00 €
	ATUM 15.5XD2 SP.. 060204	15.5	20	25	102	30	52	50	SP.. 060204	172,00 €
	ATUM 16XD2 SP.. 060204	16	25	34	110	32	54	56	SP.. 060204	172,00 €
	ATUM 16.5XD2 SP.. 060204	16.5	25	34	110	32	54	56	SP.. 060204	172,00 €
	ATUM 17XD2 SP.. 060204	17	25	34	112	34	56	56	SP.. 060204	172,00 €
	ATUM 17.5XD2 SP.. 060204	17.5	25	34	112	34	56	56	SP.. 060204	172,00 €
	ATUM 18XD2 SP.. 060204	18	25	34	114	36	58	56	SP.. 060204	172,00 €
	ATUM 18.5D2 SP.. 060204	18.5	25	34	114	36	58	56	SP.. 060204	172,00 €
	ATUM 19XD2 SP.. 060204	19	25	34	116	38	60	56	SP.. 060204	172,00 €
	ATUM 19.5XD2 SP.. 060204	19.5	25	34	116	38	60	56	SP.. 060204	172,00 €
	ATUM 20XD2 SP.. 060204	20	25	34	118	40	62	56	SP.. 060204	184,00 €
	ATUM 20.5XD2 SP.. 060204	20.5	25	34	118	40	62	56	SP.. 060204	184,00 €
	ATUM 21XD2 SP.. 060204	21	25	34	120	42	64	56	SP.. 060204	184,00 €
	ATUM 21.5XD2 SP.. 060204	21.5	25	34	120	42	64	56	SP.. 060204	184,00 €
	ATUM 22XD2 SP.. 07T308	22	25	34	122	44	66	56	SP.. 07T308	184,00 €
	ATUM 22XD2 SP.. 07T308-32	22	32	44	131	44	71	60	SP.. 07T308	202,00 €
	ATUM 22.5XD2 SP.. 07T308	22.5	25	34	122	44	66	56	SP.. 07T308	184,00 €
	ATUM 23XD2 SP.. 07T308	23	25	34	124	46	68	56	SP.. 07T308	184,00 €
	ATUM 23XD2 SP.. 07T308-32	23	32	44	133	46	73	60	SP.. 07T308	184,00 €
	ATUM 23.5XD2 SP.. 07T308	23.5	25	34	124	46	68	56	SP.. 07T308	184,00 €
	ATUM 24XD2 SP.. 07T308	24	25	34	126	48	70	56	SP.. 07T308	210,00 €
	ATUM 24XD2 SP.. 07T308-32	24	32	44	135	48	75	60	SP.. 07T308	210,00 €
	ATUM 24.5XD2 SP.. 07T308	24.5	25	34	126	48	70	56	SP.. 07T308	192,00 €
	ATUM 25XD2 SP.. 07T308	25	25	34	128	50	72	56	SP.. 07T308	210,00 €
	ATUM 25XD2 SP.. 07T308-32	25	32	44	137	50	77	60	SP.. 07T308	210,00 €
	ATUM 25.5XD2 SP.. 07T308	25.5	25	34	128	50	72	56	SP.. 07T308	192,00 €
	ATUM 26XD2 SP.. 07T308	26	25	34	130	52	74	56	SP.. 07T308	210,00 €
	ATUM 26XD2 SP.. 07T308-32	26	32	44	139	52	79	60	SP.. 07T308	210,00 €
	ATUM 26.5XD2 SP.. 07T308	26.5	25	34	130	52	74	56	SP.. 07T308	192,00 €
	ATUM 27XD2 SP.. 07T308	27	25	34	132	54	76	56	SP.. 07T308	192,00 €
	ATUM 27XD2 SP.. 07T308-32	27	32	44	141	54	81	60	SP.. 07T308	192,00 €
	ATUM 27.5XD2 SP.. 07T308	27.5	25	34	132	54	76	56	SP.. 07T308	192,00 €
	ATUM 28XD2 SP.. 090408	28	25	34	134	56	78	56	SP.. 090408	210,00 €
	ATUM 28XD2 SP.. 090408-32	28	32	44	143	56	83	60	SP.. 090408	210,00 €
	ATUM 28.5XD2 SP.. 090408	28.5	25	34	134	56	78	56	SP.. 090408	192,00 €
	ATUM 29XD2 SP.. 090408	29	25	34	136	58	80	56	SP.. 090408	210,00 €
	ATUM 29XD2 SP.. 090408-32	29	32	44	145	58	85	60	SP.. 090408	210,00 €
	ATUM 29.5XD2 SP.. 090408	29.5	25	34	136	58	80	56	SP.. 090408	192,00 €
	ATUM 30XD2 SP.. 090408	30	32	44	147	60	87	60	SP.. 090408	204,00 €
	ATUM 31XD2 SP.. 090408	31	32	44	149	62	89	60	SP.. 090408	204,00 €
	ATUM 32XD2 SP.. 090408	32	32	44	151	64	91	60	SP.. 090408	204,00 €
	ATUM 33XD2 SP.. 090408	33	32	44	153	66	93	60	SP.. 090408	204,00 €
	ATUM 34XD2 SP.. 110408	34	32	44	155	68	95	60	SP.. 110408	204,00 €
	ATUM 35XD2 SP.. 110408	35	32	44	157	70	97	60	SP.. 110408	204,00 €
	ATUM 36XD2 SP.. 110408	36	32	44	159	72	99	60	SP.. 110408	204,00 €
	ATUM 37XD2 SP.. 110408	37	32	44	161	74	101	60	SP.. 110408	204,00 €
	ATUM 38XD2 SP.. 110408	38	32	44	163	76	103	60	SP.. 110408	204,00 €
	ATUM 39XD2 SP.. 110408	39	32	44	165	78	105	60	SP.. 110408	204,00 €
	ATUM 40XD2 SP.. 110408	40	32	44	167	80	107	60	SP.. 110408	204,00 €
	ATUM 41XD2 SP.. 110408	41	32	44	169	82	109	60	SP.. 110408	211,00 €
	ATUM 42XD2 SP.. 140512	42	32	44	171	84	111	60	SP.. 140512	211,00 €
	ATUM 43XD2 SP.. 140512	43	32	44	173	86	113	60	SP.. 140512	211,00 €
	ATUM 44XD2 SP.. 140512	44	32	44	175	88	115	60	SP.. 140512	211,00 €
	ATUM 45XD2 SP.. 140512	45	40	54	192	90	122	70	SP.. 140512	231,00 €
	ATUM 46XD2 SP.. 140512	46	40	54	194	92	124	70	SP.. 140512	243,00 €
	ATUM 47XD2 SP.. 140512	47	40	54	196	94	126	70	SP.. 140512	263,00 €
	ATUM 48XD2 SP.. 140512	48	40	54	198	96	128	70	SP.. 140512	277,00 €
	ATUM 49XD2 SP.. 140512	49	40	54	200	98	130	70	SP.. 140512	290,00 €
	ATUM 50XD2 SP.. 140512	50	40	54	202	100	132	70	SP.. 140512	303,00 €

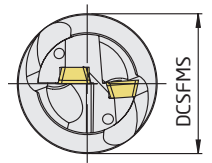
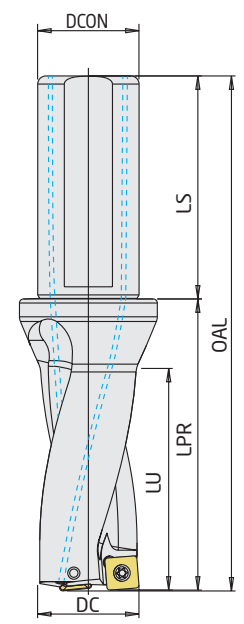

COMPATIBLE WITH TGTC INSERT
KOMPATIBEL FÜR TGTC WENDESCHNEIDPLATTEN

U-DRILL SYSTEM / VOLLBOHRER (SPMG.)

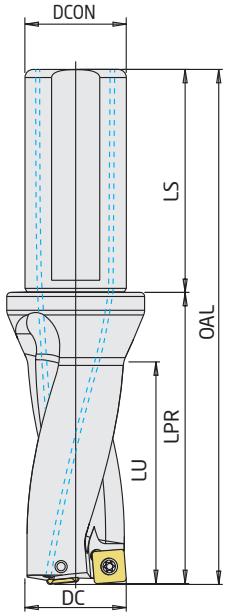
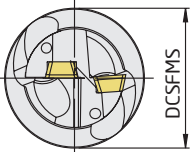
	CODE / TYP	TOOL DIMENSIONS (mm) <small>MAß</small>							CUTTING INSERT <small>WENDE PLATTE</small>	PRICE / PREIS
		DC	DCON	DCSFS	OAL	LU	LPR	LS		
D3   	ATUM 12.5XD3 SP.. 050204	12,5	20	25	108	36	58	50	SP.. 050204	184,00 €
	ATUM 13XD3 SP.. 050204	13	20	25	111	39	61	50	SP.. 050204	184,00 €
	ATUM 13.5XD3 SP.. 050204	13,5	20	25	111	39	61	50	SP.. 050204	184,00 €
	ATUM 14XD3 SP.. 050204	14	20	25	114	42	64	50	SP.. 050204	184,00 €
	ATUM 14.5XD3 SP.. 050204	14,5	20	25	114	42	64	50	SP.. 050204	184,00 €
	ATUM 15XD3 SP.. 050204	15	20	25	117	45	67	50	SP.. 050204	184,00 €
	ATUM 15.5XD3 SP.. 060204	15,5	20	25	117	45	67	50	SP.. 060204	184,00 €
	ATUM 16XD3 SP.. 060204	16	25	34	126	48	70	56	SP.. 060204	184,00 €
	ATUM 16.5XD3 SP.. 060204	16,5	25	34	126	48	70	56	SP.. 060204	184,00 €
	ATUM 17XD3 SP.. 060204	17	25	34	129	51	73	56	SP.. 060204	184,00 €
	ATUM 17.5XD3 SP.. 060204	17,5	25	34	129	51	73	56	SP.. 060204	184,00 €
	ATUM 18XD3 SP.. 060204	18	25	34	132	54	76	56	SP.. 060204	184,00 €
	ATUM 18.5XD3 SP.. 060204	18,5	25	34	132	54	76	56	SP.. 060204	184,00 €
	ATUM 19xD3 SP.. 060204	19	25	34	135	57	79	56	SP.. 060204	184,00 €
	ATUM 19.5XD3 SP.. 060204	19,5	25	34	135	57	79	56	SP.. 060204	184,00 €
	ATUM 20XD3 SP.. 060204	20	25	34	138	60	82	56	SP.. 060204	192,00 €
	ATUM 20.5XD3 SP.. 060204	20,5	25	34	138	60	82	56	SP.. 060204	192,00 €
	ATUM 21XD3 SP.. 060204	21	25	34	141	63	85	56	SP.. 060204	192,00 €
	ATUM 21.5XD3 SP.. 060204	21,5	25	34	141	63	85	56	SP.. 060204	192,00 €
	ATUM 22XD3 SP.. 07T308	22	25	34	144	66	88	56	SP.. 07T308	192,00 €
	ATUM 22XD3 SP.. 07T308-32	22	32	44	153	66	93	60	SP.. 07T308	210,00 €
	ATUM 22.5XD3 SP.. 07T308	22,5	25	34	144	66	88	56	SP.. 07T308	192,00 €
	ATUM 23XD3 SP.. 07T308	23	25	34	147	69	91	56	SP.. 07T308	192,00 €
	ATUM 23XD3 SP.. 07T308-32	23	32	44	156	69	96	60	SP.. 07T308	210,00 €
	ATUM 23.5XD3 SP.. 07T308	23,5	25	34	147	69	91	56	SP.. 07T308	192,00 €
	ATUM 24XD3 SP.. 07T308	24	25	34	150	72	94	56	SP.. 07T308	198,00 €
	ATUM 24XD3 SP.. 07T308-32	24	32	44	159	72	99	60	SP.. 07T308	219,00 €
	ATUM 24.5XD3 SP.. 07T308	24,5	25	34	150	72	94	56	SP.. 07T308	198,00 €
	ATUM 25XD3 SP.. 07T308	25	25	34	153	75	97	56	SP.. 07T308	218,00 €
	ATUM 25XD3 SP.. 07T308-32	25	32	34	162	75	102	60	SP.. 07T308	219,00 €
	ATUM 25.5XD3 SP.. 07T308	25,5	25	34	153	75	97	56	SP.. 07T308	198,00 €
	ATUM 26XD3 SP.. 07T308	26	25	34	156	78	100	56	SP.. 07T308	198,00 €
	ATUM 26XD3 SP.. 07T308-32	26	32	44	165	78	105	60	SP.. 07T308	219,00 €
	ATUM 26.5XD3 SP.. 07T308	26,5	25	34	156	78	100	56	SP.. 07T308	198,00 €
	ATUM 27XD3 SP.. 07T308	27	25	34	159	81	103	56	SP.. 07T308	198,00 €
	ATUM 27XD3 SP.. 07T308-32	27	32	44	168	81	108	60	SP.. 07T308	219,00 €
	ATUM 27.5XD3 SP.. 07T308	27,5	25	34	159	81	103	56	SP.. 07T308	198,00 €
	ATUM 28XD3 SP.. 090408	28	25	34	162	84	106	56	SP.. 090408	198,00 €
ATUM 28XD3 SP.. 090408-32	28	32	44	171	84	111	60	SP.. 090408	219,00 €	
ATUM 28.5XD3 SP.. 090408	28,5	25	34	162	84	106	56	SP.. 090408	198,00 €	
ATUM 29XD3 SP.. 090408	29	25	34	165	87	109	56	SP.. 090408	198,00 €	
ATUM 29XD3 SP.. 090408-32	29	32	44	174	87	114	6	SP.. 090408	219,00 €	
ATUM 29.5XD3 SP.. 090408	29,5	25	34	165	87	109	56	SP.. 090408	198,00 €	
ATUM 30XD3 SP.. 090408	30	32	44	177	90	117	60	SP.. 090408	204,00 €	
ATUM 30.5XD3 SP.. 090408	30,5	32	44	177	90	117	60	SP.. 090408	204,00 €	
ATUM 31XD3 SP.. 090408	31	32	44	180	93	120	60	SP.. 090408	204,00 €	
ATUM 31.5XD3 SP.. 090408	31,5	32	44	180	93	120	60	SP.. 090408	204,00 €	
ATUM 32XD3 SP.. 090408	32	32	44	183	96	123	60	SP.. 090408	204,00 €	
ATUM 32.5XD3 SP.. 090408	32,5	32	44	183	96	123	60	SP.. 090408	204,00 €	
ATUM 33XD3 SP.. 090408	33	32	44	186	99	126	60	SP.. 090408	204,00 €	
ATUM 33.5XD3 SP.. 090408	33,5	32	44	186	99	126	60	SP.. 090408	204,00 €	
ATUM 34XD3 SP.. 110408	34	32	44	189	102	129	60	SP.. 110408	204,00 €	
ATUM 34.5XD3 SP.. 110408	34,5	32	44	189	102	129	60	SP.. 110408	204,00 €	
ATUM 35XD3 SP.. 110408	35	32	44	192	105	132	60	SP.. 110408	204,00 €	
ATUM 35.5XD3 SP.. 110408	35,5	32	44	192	105	132	60	SP.. 110408	204,00 €	
ATUM 36XD3 SP.. 110408	36	32	44	195	108	135	60	SP.. 110408	204,00 €	
ATUM 36.5XD3 SP.. 110408	36,5	32	44	195	108	135	60	SP.. 110408	204,00 €	
ATUM 37XD3 SP.. 110408	37	32	44	198	111	138	60	SP.. 110408	204,00 €	
ATUM 37.5XD3 SP.. 110408	37,5	32	44	198	111	138	60	SP.. 110408	204,00 €	
ATUM 38XD3 SP.. 110408	38	32	44	201	114	141	60	SP.. 110408	204,00 €	
ATUM 38.5XD3 SP.. 110408	38,5	32	44	201	114	141	60	SP.. 110408	204,00 €	

COMPATIBLE WITH TGTC INSERT
KOMPATIBEL FÜR TGTC WENDESCHNEIDPLATTEN

U-DRILL SYSTEM / VOLLBOHRER (SPMG.)

D3	CODE / TYP	TOOL DIMENSIONS (mm) MAB							CUTTING INSERT WENDE PLATTE	PRICE / PREIS
		DC	DCON	DCSFMS	OAL	LU	LPR	LS		
	ATUM 39XD3 SP.. 110408	39	32	44	204	117	144	60	SP.. 110408	204,00 €
	ATUM 39.5XD3 SP.. 110408	39.5	32	44	204	117	144	60	SP.. 110408	204,00 €
	ATUM 40XD3 SP.. 110408	40	32	44	207	120	147	60	SP.. 110408	204,00 €
	ATUM 40.5XD3 SP.. 110408	40.5	32	44	207	120	147	60	SP.. 110408	204,00 €
	ATUM 41XD3 SP.. 110408	41	32	44	210	123	150	60	SP.. 110408	225,00 €
	ATUM 41.5XD3 SP.. 110408	41.5	32	44	210	123	150	60	SP.. 110408	225,00 €
	ATUM 42XD3 SP.. 140512	42	32	44	213	126	153	60	SP.. 140512	225,00 €
	ATUM 42.5XD3 SP.. 140512	42.5	32	44	213	126	153	60	SP.. 140512	225,00 €
	ATUM 43XD3 SP.. 140512	43	32	44	216	129	156	60	SP.. 140512	225,00 €
	ATUM 43.5XD3 SP.. 140512	43.5	32	44	216	129	156	60	SP.. 140512	225,00 €
	ATUM 44XD3 SP.. 140512	44	32	44	219	132	159	60	SP.. 140512	225,00 €
	ATUM 44.5XD3 SP.. 140512	44.5	32	44	219	132	159	60	SP.. 140512	225,00 €
	ATUM 45XD3 SP.. 140512	45	50	54	237	135	167	70	SP.. 140512	237,00 €
	ATUM 45.5XD3 SP.. 140512	45.5	50	54	237	135	167	70	SP.. 140512	237,00 €
	ATUM 46XD3 SP.. 140512	46	50	54	240	138	170	70	SP.. 140512	251,00 €
	ATUM 47XD3 SP.. 140512	47	50	54	243	141	173	70	SP.. 140512	263,00 €
	ATUM 48XD3 SP.. 140512	48	50	54	246	144	176	70	SP.. 140512	277,00 €
	ATUM 49XD3 SP.. 140512	49	50	54	249	147	179	70	SP.. 140512	290,00 €
	ATUM 50XD3 SP.. 140512	50	50	54	252	150	182	70	SP.. 140512	316,00 €
	ATUM 51XD3 SP.. 140512	51	50	54	255	153	185	70	SP.. 140512	330,00 €
	ATUM 52XD3 SP.. 140512	52	50	54	258	156	188	70	SP.. 140512	343,00 €

COMPATIBLE WITH TGTC INSERT
KOMPATIBEL FÜR TGTC WENDESCHNEIDPLATTEN

D4	CODE / TYP	TOOL DIMENSIONS (mm) MAB							CUTTING INSERT WENDE PLATTE	PRICE / PREIS
		DC	DCON	DCSFMS	OAL	LU	LPR	LS		
	ATUM 13XD4 SP.. 050204	13	20	25	124	52	74	50	SP.. 050204	280,00 €
	ATUM 14XD4 SP.. 050204	14	20	25	128	56	78	50	SP.. 050204	280,00 €
	ATUM 14.5XD4 SP.. 050204	14.5	20	25	128	56	75	50	SP.. 050204	280,00 €
	ATUM 15XD4 SP.. 050204	15	20	25	132	60	82	50	SP.. 050204	280,00 €
	ATUM 16XD4 SP.. 060204	16	25	34	142	64	86	56	SP.. 060204	280,00 €
	ATUM 17XD4 SP.. 060204	17	25	34	146	68	90	56	SP.. 060204	280,00 €
	ATUM 17.5XD4 SP.. 060204	17.5	25	34	146	68	90	56	SP.. 060204	280,00 €
	ATUM 18XD4 SP.. 060204	18	25	34	150	72	94	56	SP.. 060204	280,00 €
	ATUM 19XD4 SP.. 060204	19	25	34	154	76	98	56	SP.. 060204	280,00 €
	ATUM 19.5XD4 SP.. 060204	19.5	25	34	154	76	98	56	SP.. 060204	280,00 €
	ATUM 20XD4 SP.. 060204	20	25	34	158	80	102	56	SP.. 060204	292,00 €
	ATUM 21XD4 SP.. 060204	21	25	34	162	84	106	56	SP.. 060204	292,00 €
	ATUM 22XD4 SP.. 07T308	22	25	34	166	88	110	56	SP.. 07T308	292,00 €
	ATUM 23XD4 SP.. 07T308	23	25	34	170	92	114	56	SP.. 07T308	292,00 €
	ATUM 23.5XD4 SP.. 07T308	23.5	25	34	170	92	114	56	SP.. 07T308	292,00 €
	ATUM 24XD4 SP.. 07T308	24	25	34	174	96	118	56	SP.. 07T308	305,00 €
	ATUM 25XD4 SP.. 07T308	25	25	34	178	100	122	56	SP.. 07T308	305,00 €
	ATUM 26XD4 SP.. 07T308	26	25	34	182	104	126	56	SP.. 07T308	305,00 €
	ATUM 27XD4 SP.. 07T308	27	25	34	186	108	130	56	SP.. 07T308	305,00 €
	ATUM 27.5XD4 SP.. 07T308	27.5	25	34	186	108	130	56	SP.. 07T308	305,00 €
	ATUM 28XD4 SP.. 090408	28	25	34	190	112	134	56	SP.. 090408	305,00 €
	ATUM 29XD4 SP.. 090408	29	25	34	194	116	138	56	SP.. 090408	305,00 €
	ATUM 30XD4 SP.. 090408	30	32	44	207	120	147	60	SP.. 090408	317,00 €
	ATUM 31XD4 SP.. 090408	31	32	44	211	124	151	60	SP.. 090408	317,00 €
	ATUM 32XD4 SP.. 090408	32	32	44	215	128	155	60	SP.. 090408	317,00 €
	ATUM 33XD4 SP.. 090408	33	32	44	219	132	159	60	SP.. 090408	317,00 €
	ATUM 33.5XD4 SP.. 090408	33.5	32	44	219	132	159	60	SP.. 090408	317,00 €
	ATUM 34XD4 SP.. 110408	34	32	44	223	136	163	60	SP.. 110408	317,00 €
	ATUM 35XD4 SP.. 110408	35	32	44	227	140	167	60	SP.. 110408	317,00 €
	ATUM 36XD4 SP.. 110408	36	32	44	231	144	171	60	SP.. 110408	317,00 €
	ATUM 37XD4 SP.. 110408	37	32	44	235	148	175	60	SP.. 110408	317,00 €
	ATUM 38XD4 SP.. 110408	38	32	44	239	152	179	60	SP.. 110408	317,00 €
	ATUM 39XD4 SP.. 110408	39	32	44	243	156	183	60	SP.. 110408	317,00 €
	ATUM 40XD4 SP.. 110408	40	32	44	247	160	187	60	SP.. 110408	317,00 €
	ATUM 41XD4 SP.. 110408	41	32	44	251	164	191	60	SP.. 110408	341,00 €
	ATUM 42XD4 SP.. 140512	42	32	44	255	168	195	60	SP.. 140512	341,00 €
	ATUM 43XD4 SP.. 140512	43	32	44	259	172	199	60	SP.. 140512	341,00 €
	ATUM 44XD4 SP.. 140512	44	32	44	263	176	203	60	SP.. 140512	341,00 €
	ATUM 46XD4 SP.. 140512	46	40	54	286	184	216	70	SP.. 140512	421,00 €

COMPATIBLE WITH TGTC INSERT
KOMPATIBEL FÜR TGTC WENDESCHNEIDPLATTEN

U-DRILL SYSTEM / VOLLBOHRER (SPMG.)

	CODE / TYP	TOOL DIMENSIONS (mm) MAß							CUTTING INSERT WENDE PLATTE	PRICE / PREIS
		DC	DCON	DCSPMS	OAL	LU	LPR	LS		
D5  COMPATIBLE WITH TGTC INSERT KOMPATIBEL FÜR TGTC WENDESCHNEIDPLATTEN	ATUM 13XD5 SP.. 050204	13	20	25	137	65	87	50	SP.. 050204	275,00 €
	ATUM 14XD5 SP.. 050204	14	20	25	142	70	92	50	SP.. 050204	275,00 €
	ATUM 14.5XD5 SP.. 050204	14.5	20	25	142	70	92	50	SP.. 050204	275,00 €
	ATUM 15XD5 SP.. 050204	15	20	25	147	75	97	50	SP.. 050204	275,00 €
	ATUM 16XD5 SP.. 060204	16	25	34	158	80	102	56	SP.. 060204	275,00 €
	ATUM 17XD5 SP.. 060204	17	25	34	163	85	107	56	SP.. 060204	275,00 €
	ATUM 17XD5 SP.. 060204-32	17	32	34	163	85	107	56	SP.. 060204	302,00 €
	ATUM 18XD5 SP.. 060204	18	25	34	168	90	112	56	SP.. 060204	275,00 €
	ATUM 19XD5 SP.. 060204	19	25	34	173	95	117	56	SP.. 060204	275,00 €
	ATUM 20XD5 SP.. 060204	20	25	34	178	100	122	56	SP.. 060204	286,00 €
	ATUM 21XD5 SP.. 060204	21	25	34	183	105	127	56	SP.. 060204	286,00 €
	ATUM 22XD5 SP.. 07T308	22	25	34	188	110	132	56	SP.. 07T308	286,00 €
	ATUM 22XD5 SP.. 07T308-32	22	32	44	197	110	137	60	SP.. 07T308	315,00 €
	ATUM 23XD5 SP.. 07T308	23	25	34	193	115	137	56	SP.. 07T308	286,00 €
	ATUM 23XD5 SP.. 07T308-32	23	32	44	202	115	142	60	SP.. 07T308	315,00 €
	ATUM 24XD5 SP.. 07T308-32	24	32	44	207	120	147	60	SP.. 07T308	326,00 €
	ATUM 25XD5 SP.. 07T308	25	25	34	203	125	147	56	SP.. 07T308	297,00 €
	ATUM 25XD5 SP.. 07T308-32	25	32	44	212	125	152	60	SP.. 07T308	326,00 €
	ATUM 26XD5 SP.. 07T308	26	25	34	208	130	152	56	SP.. 07T308	297,00 €
	ATUM 26XD5 SP.. 07T308-32	26	32	44	217	130	157	60	SP.. 07T308	326,00 €
	ATUM 27XD5 SP.. 07T308	27	25	34	213	135	157	56	SP.. 07T308	297,00 €
	ATUM 27XD5 SP.. 07T308-32	27	32	44	222	135	162	60	SP.. 07T308	326,00 €
	ATUM 28XD5 SP.. 090408-32	28	32	44	227	140	167	60	SP.. 090408	326,00 €
	ATUM 29XD5 SP.. 090408-32	29	32	44	232	145	172	60	SP.. 090408	326,00 €
	ATUM 30XD5 SP.. 090408	30	32	44	237	150	177	60	SP.. 090408	306,00 €
	ATUM 31XD5 SP.. 090408	31	32	44	242	155	182	60	SP.. 090408	306,00 €
	ATUM 32XD5 SP.. 090408	32	32	44	247	160	187	60	SP.. 090408	306,00 €
	ATUM 33XD5 SP.. 090408	33	32	44	252	165	192	60	SP.. 090408	306,00 €

U-DRILL SYSTEM / VOLLBOHRER (SPGT.)

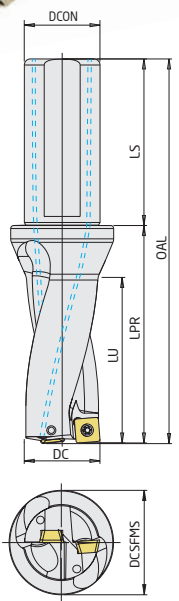
	CODE / TYP	TOOL DIMENSIONS (mm) MAß							CUTTING INSERT WENDE PLATTE	PRICE / PREIS
		DC	DCON	DCSPMS	OAL	LU	LPR	LS		
D2   COMPATIBLE WITH ZCC INSERT KOMPATIBEL FÜR ZCC WENDESCHNEIDPLATTEN	ATUM 12.5XD2 SPGT 050204	12.5	20	25	96	24	46	50	SPGT 050204	172,00 €
	ATUM 13XD2 SPGT 050204	13	20	25	98	26	48	50	SPGT 050204	172,00 €
	ATUM 13.5XD2 SPGT 050204	13.5	20	25	98	26	48	50	SPGT 050204	172,00 €
	ATUM 14XD2 SPGT 050204	14	20	25	100	28	50	50	SPGT 050204	172,00 €
	ATUM 15XD2 SPGT 050204	15	20	25	102	30	52	50	SPGT 050204	172,00 €
	ATUM 16XD2 SPGT 060204	16	25	34	110	32	54	56	SPGT 060204	172,00 €
	ATUM 16.5XD2 SPGT 060204	16.5	25	34	110	32	54	56	SPGT 060204	172,00 €
	ATUM 17XD2 SPGT 060204	17	25	34	112	34	56	56	SPGT 060204	172,00 €
	ATUM 17.5XD2 SPGT 060204	17.5	25	34	112	34	56	56	SPGT 060204	172,00 €
	ATUM 18XD2 SPGT 060204	18	25	34	114	36	58	56	SPGT 060204	172,00 €
	ATUM 19XD2 SPGT 060204	19	25	34	116	38	60	56	SPGT 060204	172,00 €
	ATUM 20XD2 SPGT 060204	20	25	34	118	40	62	56	SPGT 060204	184,00 €
	ATUM 21XD2 SPGT 060204	21	25	34	120	42	64	56	SPGT 060204	184,00 €
	ATUM 22XD2 SPGT 07T308	22	25	34	122	44	66	56	SPGT 07T308	184,00 €
	ATUM 22.5XD2 SPGT 07T308	22.5	25	34	122	44	66	56	SPGT 07T308	184,00 €
	ATUM 23XD2 SPGT 07T308	23	25	34	124	46	68	56	SPGT 07T308	184,00 €
	ATUM 23.5XD2 SPGT 07T308	23.5	25	34	124	46	68	56	SPGT 07T308	184,00 €
	ATUM 24XD2 SPGT 07T308	24	25	34	126	48	70	56	SPGT 07T308	192,00 €
	ATUM 24.5XD2 SPGT 07T308	24.5	25	34	126	48	70	56	SPGT 07T308	192,00 €
	ATUM 25XD2 SPGT 07T308	25	25	34	128	50	72	56	SPGT 07T308	192,00 €
	ATUM 26XD2 SPGT 07T308	26	25	34	130	52	74	56	SPGT 07T308	192,00 €
	ATUM 28XD2 SPGT 090408	28	25	34	134	56	78	56	SPGT 090408	192,00 €
	ATUM 29XD2 SPGT 090408	29	25	34	136	58	80	56	SPGT 090408	192,00 €
	ATUM 30XD2 SPGT 090408	30	32	44	147	60	87	60	SPGT 090408	204,00 €
	ATUM 31XD2 SPGT 090408	31	32	44	149	62	89	60	SPGT 090408	204,00 €
	ATUM 32XD2 SPGT 090408	32	32	44	151	64	91	60	SPGT 090408	204,00 €
	ATUM 35XD2 SPGT 110408	35	32	44	157	70	97	60	SPGT 110408	204,00 €
	ATUM 36XD2 SPGT 110408	36	32	44	159	72	99	60	SPGT 110408	204,00 €
	ATUM 40XD2 SPGT 110408	40	32	44	167	80	107	60	SPGT 110408	204,00 €

U-DRILL SYSTEM / VOLLBOHRER (SPGT.)

D3	CODE / TYP	TOOL DIMENSIONS (mm) MAB							CUTTING INSERT WENDE PLATTE	PRICE / PREIS
		DC	DCON	DCSFMS	OAL	LU	LPR	LS		
	ATUM 12.5XD3 SPGT 050204	12,5	20	25	108	36	58	50	SPGT 050204	184,00 €
	ATUM 13XD3 SPGT 050204	13	20	25	111	39	61	50	SPGT 050204	184,00 €
	ATUM 13.5XD3 SPGT 050204	13,5	20	25	111	39	61	50	SPGT 050204	184,00 €
	ATUM 14XD3 SPGT 050204	14	20	25	114	42	64	50	SPGT 050204	184,00 €
	ATUM 14.5XD3 SPGT 050204	14,5	20	25	114	42	64	50	SPGT 050204	184,00 €
	ATUM 15XD3 SPGT 050204	15	20	25	117	45	67	50	SPGT 050204	184,00 €
	ATUM 15.5XD3 SPGT 060204	15,5	20	25	117	45	67	50	SPGT 060204	184,00 €
	ATUM 16XD3 SPGT 060204	16	25	34	126	48	70	56	SPGT 060204	184,00 €
	ATUM 16.5XD3 SPGT 060204	16,5	25	34	126	48	70	56	SPGT 060204	184,00 €
	ATUM 17XD3 SPGT 060204	17	25	34	129	51	73	56	SPGT 060204	184,00 €
	ATUM 17.5XD3 SPGT 060204	17,5	25	34	129	51	73	56	SPGT 060204	184,00 €
	ATUM 18XD3 SPGT 060204	18	25	34	132	54	76	56	SPGT 060204	184,00 €
	ATUM 18.5XD3 SPGT 060204	18,5	25	34	132	54	76	56	SPGT 060204	184,00 €
	ATUM 19XD3 SPGT 060204	19	25	34	135	57	79	56	SPGT 060204	184,00 €
	ATUM 19.5XD3 SPGT 060204	19,5	25	34	135	57	79	56	SPGT 060204	184,00 €
	ATUM 20XD3 SPGT 060204	20	25	34	138	60	82	56	SPGT 060204	192,00 €
	ATUM 20.5XD3 SPGT 060204	20,5	25	34	138	60	82	56	SPGT 060204	192,00 €
	ATUM 21XD3 SPGT 060204	21	25	34	141	63	85	56	SPGT 060204	192,00 €
	ATUM 21.5XD3 SPGT 060204	21,5	25	34	141	63	85	56	SPGT 060204	192,00 €
	ATUM 22XD3 SPGT 07T308	22	25	34	144	66	88	56	SPGT 07T308	192,00 €
	ATUM 22.5XD3 SPGT 07T308	22,5	25	34	144	66	88	56	SPGT 07T308	192,00 €
	ATUM 23XD3 SPGT 07T308	23	25	34	147	69	91	56	SPGT 07T308	192,00 €
	ATUM 23.5XD3 SPGT 07T308	23,5	25	34	147	69	91	56	SPGT 07T308	192,00 €
	ATUM 24XD3 SPGT 07T308	24	25	34	150	72	94	56	SPGT 07T308	198,00 €
	ATUM 24.5XD3 SPGT 07T308	24,5	25	34	150	72	94	56	SPGT 07T308	198,00 €
	ATUM 25XD3 SPGT 07T308	25	25	34	153	75	97	56	SPGT 07T308	198,00 €
	ATUM 25.5XD3 SPGT 07T308	25,5	25	34	153	75	97	56	SPGT 07T308	198,00 €
	ATUM 26XD3 SPGT 07T308	26	25	34	156	78	100	56	SPGT 07T308	198,00 €
	ATUM 26.5XD3 SPGT 07T308	26,5	25	34	156	78	100	56	SPGT 07T308	198,00 €
	ATUM 27XD3 SPGT 07T308	27	25	34	159	81	103	56	SPGT 07T308	198,00 €
	ATUM 27.5XD3 SPGT 07T308	27,5	25	34	159	81	103	56	SPGT 07T308	198,00 €
	ATUM 28XD3 SPGT 090408	28	25	34	162	84	106	56	SPGT 090408	198,00 €
	ATUM 28.5XD3 SPGT 090408	28,5	25	34	162	84	106	56	SPGT 090408	198,00 €
	ATUM 29XD3 SPGT 090408	29	25	34	165	87	109	56	SPGT 090408	198,00 €
	ATUM 29.5XD3 SPGT 090408	29,5	25	34	165	87	109	56	SPGT 090408	198,00 €
	ATUM 30XD3 SPGT 090408	30	32	44	177	90	117	60	SPGT 090408	204,00 €
	ATUM 31XD3 SPGT 090408	31	32	44	180	93	120	60	SPGT 090408	204,00 €
	ATUM 32XD3 SPGT 090408	32	32	44	183	96	123	60	SPGT 090408	204,00 €
	ATUM 33XD3 SPGT 090408	33	32	44	186	99	126	60	SPGT 090408	204,00 €
	ATUM 34XD3 SPGT 110408	34	32	44	189	102	129	60	SPGT 110408	204,00 €
	ATUM 35XD3 SPGT 110408	35	32	44	192	105	132	60	SPGT 110408	204,00 €
	ATUM 36XD3 SPGT 110408	36	32	44	195	108	135	60	SPGT 110408	204,00 €
	ATUM 36.5XD3 SPGT 110408	36,5	32	44	195	110	135	60	SPGT 110408	204,00 €
	ATUM 37XD3 SPGT 110408	37	32	44	198	111	138	60	SPGT 110408	204,00 €
	ATUM 38XD3 SPGT 110408	38	32	44	201	114	141	60	SPGT 110408	204,00 €
	ATUM 39XD3 SPGT 110408	39	32	44	204	117	144	60	SPGT 110408	204,00 €
	ATUM 40XD3 SPGT 110408	40	32	44	207	120	147	60	SPGT 110408	204,00 €
	ATUM 42XD3 SPGT 140512	42	32	44	213	126	153	60	SPGT 140512	225,00 €
	ATUM 43XD3 SPGT 140512	43	32	44	216	129	156	60	SPGT 140512	225,00 €
	ATUM 44XD3 SPGT 140512	44	32	44	219	132	159	60	SPGT 140512	225,00 €
	ATUM 49XD3 SPGT 140512	49	40	54	249	147	179	70	SPGT 140512	290,00 €
	ATUM 50XD3 SPGT 140512	50	40	54	252	150	182	70	SPGT 140512	316,00 €

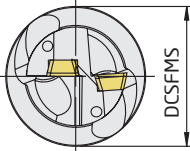
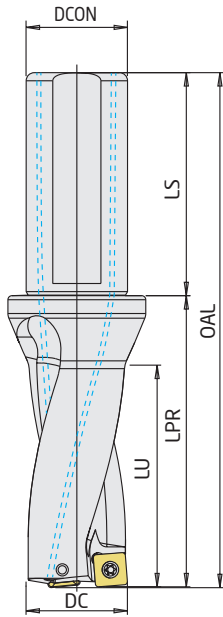

COMPATIBLE WITH ZCC INSERT
KOMPATIBEL FÜR ZCC WENDESCHNEIDPLATTEN

U-DRILL SYSTEM / VOLLBOHRER (SPGT.)

	CODE / TYP	TOOL DIMENSIONS (mm) <i>MAB</i>						CUTTING INSERT WENDE PLATTE	PRICE / PREIS	
		DC	DCON	DCSFMS	OAL	LU	LPR			LS
D4  <p>COMPATIBLE WITH ZCC INSERT KOMPATIBEL FÜR ZCC WENDESCHNEIDPLATTEN</p>	ATUM 13XD4 SPGT 050204	13	20	25	124	52	74	50	SPGT 050204	280,00 €
	ATUM 14XD4 SPGT 050204	14	20	25	128	56	78	50	SPGT 050204	280,00 €
	ATUM 14.5XD4 SPGT 050204	14.5	20	25	128	58	78	50	SPGT 050204	303,00 €
	ATUM 15XD4 SPGT 050204	15	20	25	132	60	82	50	SPGT 050204	280,00 €
	ATUM 16XD4 SPGT 060204	16	25	34	142	64	86	56	SPGT 060204	280,00 €
	ATUM 17XD4 SPGT 060204	17	25	34	146	68	90	56	SPGT 060204	280,00 €
	ATUM 17.5XD4 SPGT 060204	17.5	25	34	146	68	90	56	SPGT 060204	280,00 €
	ATUM 18XD4 SPGT 060204	18	25	34	150	72	94	56	SPGT 060204	280,00 €
	ATUM 19XD4 SPGT 060204	19	25	34	154	76	98	56	SPGT 060204	280,00 €
	ATUM 19.5XD4 SPGT 060204	19.5	25	34	154	76	98	56	SPGT 060204	280,00 €
	ATUM 20XD4 SPGT 060204	20	25	34	158	80	102	56	SPGT 060204	292,00 €
	ATUM 21XD4 SPGT 060204	21	25	34	162	84	106	56	SPGT 060204	292,00 €
	ATUM 22XD4 SPGT 07T308	22	25	34	166	88	110	56	SPGT 07T308	292,00 €
	ATUM 23XD4 SPGT 07T308	23	25	34	170	92	114	56	SPGT 07T308	292,00 €
	ATUM 23.5XD4 SPGT 07T308	23.5	25	34	170	92	114	56	SPGT 07T308	292,00 €
	ATUM 24XD4 SPGT 07T308	24	25	34	174	96	118	56	SPGT 07T308	305,00 €
	ATUM 25XD4 SPGT 07T308	25	25	34	178	100	122	56	SPGT 07T308	305,00 €
	ATUM 26XD4 SPGT 07T308	26	25	34	182	104	126	56	SPGT 07T308	305,00 €
	ATUM 27.5XD4 SPGT 07T308	27.5	25	34	186	108	130	56	SPGT 07T308	305,00 €
	ATUM 28XD4 SPGT 090408	28	25	34	190	112	134	56	SPGT 090408	305,00 €
	ATUM 29XD4 SPGT 090408	29	25	34	194	116	138	56	SPGT 090408	305,00 €
	ATUM 30XD4 SPGT 090408	30	32	44	207	120	147	60	SPGT 090408	317,00 €
	ATUM 31XD4 SPGT 090408	31	32	44	211	124	151	60	SPGT 090408	343,00 €
	ATUM 32XD4 SPGT 090408	32	32	44	215	128	155	60	SPGT 090408	343,00 €
	ATUM 33.5XD4 SPGT 090408	33.5	32	44	219	132	159	60	SPGT 090408	317,00 €
	ATUM 38XD4 SPGT 110408	38	32	44	239	152	179	60	SPGT 110408	317,00 €

U-DRILL SYSTEM / VOLLBOHRER (SOMX - SOMT.)

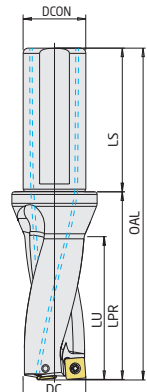
	CODE / TYP	TOOL DIMENSIONS (mm) <i>MAB</i>						CUTTING INSERT WENDE PLATTE	PRICE / PREIS	
		DC	DCON	DCSFMS	OAL	LU	LPR			LS
D3   <p>COMPATIBLE WITH ISCR INSERT KOMPATIBEL FÜR ISCR WENDESCHNEIDPLATTEN</p>	ATUM 14XD3 SO.. 050204	14	20	25	114	42	64	50	SO.. 050304	184,00 €
	ATUM 15XD3 SO.. 050204	15	20	25	117	45	67	50	SO.. 050304	184,00 €
	ATUM 16XD3 SO.. 050204	16	25	34	126	48	70	56	SO.. 050304	184,00 €
	ATUM 16.5XD3 SO.. 050204	16.5	25	34	126	48	70	56	SO.. 050304	184,00 €
	ATUM 17XD3 SO.. 050204	17	25	34	129	51	73	56	SO.. 050304	184,00 €
	ATUM 17.5XD3 SO.. 050204	17.5	25	34	129	51	73	56	SO.. 050304	184,00 €
	ATUM 18XD3 SO.. 060304	18	25	34	132	54	76	56	SO.. 060304	184,00 €
	ATUM 19XD3 SO.. 060304	19	25	34	135	57	79	56	SO.. 060304	184,00 €
	ATUM 20XD3 SO.. 060304	20	25	34	138	60	82	56	SO.. 060304	192,00 €
	ATUM 21XD3 SO.. 070305	21	25	34	140	64	84	56	SO.. 07T308	192,00 €
	ATUM 22XD3 SO.. 070305	22	25	34	144	66	88	56	SO.. 07T308	192,00 €
	ATUM 22.5XD3 SO.. 070305	22.5	25	34	144	66	88	56	SO.. 07T308	192,00 €
	ATUM 23XD3 SO.. 070305	23	25	34	147	69	91	56	SO.. 07T308	192,00 €
	ATUM 24XD3 SO.. 070305	24	25	34	150	72	94	56	SO.. 07T308	198,00 €
	ATUM 25XD3 SO.. 09T306	25	25	34	153	75	97	56	SO.. 090408	198,00 €
	ATUM 26XD3 SO.. 09T306	26	25	34	156	78	100	56	SO.. 090408	198,00 €
	ATUM 27XD3 SO.. 09T306	27	25	34	159	81	103	56	SO.. 090408	198,00 €
	ATUM 29XD3 SO.. 09T306	29	25	34	165	87	109	56	SO.. 090408	198,00 €
	ATUM 30XD3 SO.. 09T306	30	32	44	177	90	117	60	SO.. 090408	204,00 €
	ATUM 31XD3 SO.. 09T306	31	32	44	180	93	120	60	SO.. 090408	204,00 €
	ATUM 33XD3 SO.. 09T306	33	32	44	186	99	126	60	SO.. 090408	204,00 €
	ATUM 35XD3 SO.. 120408	35	32	44	192	105	132	60	SO.. 120408	204,00 €
	ATUM 36XD3 SO.. 120408	36	32	44	195	108	135	60	SO.. 120408	204,00 €
	ATUM 37XD3 SO.. 120408	37	32	44	198	111	138	60	SO.. 120408	204,00 €
	ATUM 38XD3 SO.. 120408	38	32	44	201	114	141	60	SO.. 120408	204,00 €
	ATUM 39XD3 SO.. 120408	39	32	44	204	117	144	60	SO.. 120408	204,00 €
	ATUM 40XD3 SO.. 120408	40	32	44	207	120	147	60	SO.. 120408	204,00 €
	ATUM 43XD3 SO.. 120408	43	32	44	216	129	156	60	SO.. 120408	226,00 €

U-DRILL SYSTEM / VOLLBOHRER (SOMX - SOMT.)

	CODE / TYP	TOOL DIMENSIONS (mm) MAß							CUTTING INSERT WENDE PLATTE	PRICE / PREIS
		DC	DCON	DCSFM	OAL	LU	LPR	LS		
D4 	ATUM 14XD4 SO.. 050204	14	20	25	128	56	78	50	SO.. 050204	280,00 €
	ATUM 14.5XD4 SO.. 050204	14.5	20	25	128	56	78	50	SO.. 050204	280,00 €
	ATUM 15XD4 SO.. 050204	15	20	25	132	60	82	50	SO.. 050204	280,00 €
	ATUM 15.5XD4 SO.. 050204	15.5	20	25	132	60	82	50	SO.. 050204	280,00 €
	ATUM 17XD4 SO.. 050204	17	25	34	146	68	90	56	SO.. 050204	280,00 €
	ATUM 19XD4 SO.. 060304	19	25	34	154	76	98	56	SO.. 060304	280,00 €
	ATUM 19.5XD4 SO.. 060304	19.5	25	34	154	76	98	56	SO.. 060304	280,00 €
	ATUM 20XD4 SO.. 060304	20	25	34	158	80	102	56	SO.. 060304	292,00 €
	ATUM 21XD4 SO.. 070305	21	25	34	162	84	106	56	SO.. 070305	292,00 €
	ATUM 22XD4 SO.. 070305	22	25	34	166	88	110	56	SO.. 070305	292,00 €
	ATUM 22.5XD4 SO.. 070305	22.5	25	34	166	88	110	56	SO.. 070305	292,00 €
	ATUM 23XD4 SO.. 070305	23	25	34	170	92	114	56	SO.. 070305	292,00 €
	ATUM 24XD4 SO.. 070305	24	25	34	174	96	118	56	SO.. 070305	305,00 €
	ATUM 25XD4 SO.. 09T306	25	25	34	178	100	122	56	SO.. 09T306	305,00 €
	ATUM 27XD4 SO.. 09T306	27	25	34	186	108	130	56	SO.. 09T306	305,00 €
	ATUM 28XD4 SO.. 09T306	28	25	34	190	112	134	56	SO.. 09T306	305,00 €
	ATUM 29XD4 SO.. 09T306	29	25	34	194	116	138	56	SO.. 09T306	305,00 €
	ATUM 30XD4 SO.. 09T306	30	32	44	207	120	147	60	SO.. 09T306	317,00 €
	ATUM 31XD4 SO.. 09T306	31	32	44	211	124	151	60	SO.. 09T306	317,00 €
	ATUM 33XD4 SO.. 09T306	33	32	44	219	132	159	60	SO.. 09T306	317,00 €
ATUM 34XD4 SO.. 09T306	34	32	44	223	136	163	60	SO.. 09T306	317,00 €	
ATUM 35XD4 SO.. 120408	35	32	44	227	140	167	60	SO.. 120408	317,00 €	

COMPATIBLE WITH ISCR INSERT
KOMPATIBEL FÜR ISCR WENDESCHNEIDPLATTEN

U-DRILL SYSTEM / VOLLBOHRER (SPMT - XOMT.)

	CODE / TYP	TOOL DIMENSIONS (mm) MAß							CUTTING INSERT WENDE PLATTE	PRICE / PREIS
		DC	DCON	DCSFM	OAL	LU	LPR	LS		
D2 	ATUM 14XD2 KDR 0502..	14	20	25	100	28	50	50	SPMT 050204-XOMT 050204	172,00 €
	ATUM 18XD2 KDR 0602..	18	25	34	114	36	58	56	SPMT 060205-XOMT 060204	172,00 €
	ATUM 20XD2 KDR 07T2..	20	25	34	118	40	62	56	SPMT 07T208-XOMT 07T205	184,00 €
	ATUM 22XD2 KDR 07T2..	22	25	34	122	44	66	56	SPMT 07T208-XOMT 07T205	184,00 €
	ATUM 24XD2 KDR 0903..	24	25	34	126	48	70	56	SPMT 090308-XOMT 090305	192,00 €
	ATUM 25XD2 KDR 0903..	25	25	34	128	50	72	56	SPMT 090308-XOMT 090305	192,00 €
	ATUM 26XD2 KDR 0903..	26	25	34	130	52	74	56	SPMT 090308-XOMT 090305	192,00 €
	ATUM 28XD2 KDR 0903..	28	25	34	134	56	78	56	SPMT 090308-XOMT 090305	192,00 €
	ATUM 30XD2 KDR 11T3..	30	25	34	147	60	87	60	SPMT 11T308-XOMT 11T306	204,00 €
	ATUM 32XD2 KDR 11T3..	32	32	44	151	64	91	60	SPMT 11T308-XOMT 11T306	204,00 €
	ATUM 34XD2 KDR 11T3..	34	32	44	155	68	95	60	SPMT 11T308-XOMT 11T306	204,00 €
	ATUM 36XD2 KDR 1304..	36	32	44	159	72	99	60	SPMT 13T410-XOMT 13T406	204,00 €
	ATUM 37XD2 KDR 1304..	37	32	44	161	74	101	60	SPMT 13T410-XOMT 13T406	204,00 €
	ATUM 38XD2 KDR 1304..	38	32	44	163	76	103	60	SPMT 13T410-XOMT 13T406	204,00 €

COMPATIBLE WITH KRLY INSERT
KOMPATIBEL FÜR KRLY WENDESCHNEIDPLATTEN

U-DRILL SYSTEM / VOLLBOHRER (SPGT.)

	CODE / TYP	TOOL DIMENSIONS (mm) MAß							CUTTING INSERT WENDE PLATTE	PRICE / PREIS
		DC	DCON	DCSFM	OAL	LU	LPR	LS		
D5 	ATUM 22XD5 SPGT 07T308	22	25	34	188	110	132	56	SPGT 07T308	286,00 €
	ATUM 26XD5 SPGT 07T308-32	26	32	44	217	130	157	60	SPGT 07T308	326,00 €

COMPATIBLE WITH ZCC INSERT
KOMPATIBEL FÜR ZCC WENDESCHNEIDPLATTEN

U-DRILL SYSTEM / VOLLBOHRER (SOMX)

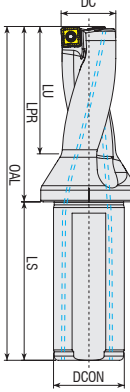
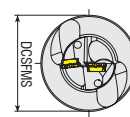
	CODE / TYP	TOOL DIMENSIONS (mm) <small>MAB</small>						CUTTING INSERT WENDE PLATTE	PRICE / PREIS	
		DC	DCON	DCSFS	OAL	LU	LPR			LS
D2    <p>COMPATIBLE WITH MTSBH INSERT KOMPATIBEL FÜR MTSBH WENDESCHNEIDPLATTEN</p>	ATUM 14XD2 SO.. 052704	14	20	25	100	28	50	50	SOMX 052704	189,00 €
	ATUM 15XD2 SO.. 052704	15	20	25	102	30	52	50	SOMX 052704	189,00 €
	ATUM 16XD2 SO.. 052704	16	25	34	110	32	54	56	SOMX 052704	189,00 €
	ATUM 17XD2 SO.. 063005	17	25	34	112	34	56	56	SOMX 063005	189,00 €
	ATUM 18XD2 SO.. 063005	18	25	34	114	36	58	56	SOMX 063005	189,00 €
	ATUM 19XD2 SO.. 063005	19	25	34	116	38	60	56	SOMX 063005	189,00 €
	ATUM 20XD2 SO.. 073505	20	25	34	118	40	62	56	SOMX 073505	202,00 €
	ATUM 21XD2 SO.. 073505	21	25	34	120	42	64	56	SOMX 073505	202,00 €
	ATUM 22XD2 SO.. 073505	22	25	34	122	44	66	56	SOMX 073505	202,00 €
	ATUM 23XD2 SO.. 084005	23	25	34	124	46	68	56	SOMX 084005	202,00 €
	ATUM 24XD2 SO.. 084005	24	25	34	126	48	70	56	SOMX 084005	211,00 €
	ATUM 25XD2 SO.. 084005	25	25	34	128	50	72	56	SOMX 084005	211,00 €
	ATUM 26XD2 SO.. 084005	26	25	34	130	52	74	56	SOMX 084005	211,00 €
	ATUM 28XD2 SO.. 094506	28	25	34	134	56	78	56	SOMX 094506	211,00 €
	ATUM 30XD2 SO.. 094506	30	32	44	147	60	87	60	SOMX 094506	224,00 €

U-DRILL SYSTEM / VOLLBOHRER (SOMX)

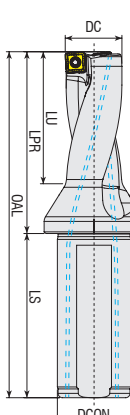
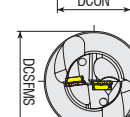
	CODE / TYP	TOOL DIMENSIONS (mm) <small>MAB</small>						CUTTING INSERT WENDE PLATTE	PRICE / PREIS	
		DC	DCON	DCSFS	OAL	LU	LPR			LS
D3    <p>COMPATIBLE WITH MTSBH INSERT KOMPATIBEL FÜR MTSBH WENDESCHNEIDPLATTEN</p>	ATUM 14XD3 SO.. 052704	14	20	25	114	42	64	50	SOMX 052704	202,00 €
	ATUM 14.5XD3 SO.. 052704	14.5	20	25	114	43.5	64	50	SOMX 052704	202,00 €
	ATUM 15XD3 SO.. 052704	15	20	25	117	45	67	50	SOMX 052704	202,00 €
	ATUM 15.5XD3 SO.. 052704	15.5	25	34	126	49.5	70	56	SOMX 052704	202,00 €
	ATUM 16XD3 SO.. 052704	16	25	34	126	48	70	56	SOMX 052704	202,00 €
	ATUM 16.5XD3 SO.. 052704	16.5	25	34	126	49.5	70	56	SOMX 052704	202,00 €
	ATUM 17XD3 SO.. 063005	17	25	34	129	51	73	56	SOMX 052704	202,00 €
	ATUM 17.5XD3 SO.. 063005	17.5	25	34	129	52.5	73	56	SOMX 063005	202,00 €
	ATUM 18XD3 SO.. 063005	18	25	34	132	54	76	56	SOMX 063005	202,00 €
	ATUM 18.5XD3 SO.. 063005	18.5	25	34	132	55.5	76	56	SOMX 063005	202,00 €
	ATUM 19XD3 SO.. 063005	19	25	34	135	57	79	56	SOMX 063005	202,00 €
	ATUM 19.5XD3 SO.. 063005	19.5	25	34	135	58.5	79	56	SOMX 063005	202,00 €
	ATUM 20XD3 SO.. 073505	20	25	34	138	60	82	56	SOMX 073505	211,00 €
	ATUM 20.5XD3 SO.. 073505	20.5	25	34	138	61.5	82	56	SOMX 073505	211,00 €
	ATUM 21XD3 SO.. 073505	21	25	34	141	63	85	56	SOMX 073505	211,00 €
	ATUM 21.5XD3 SO.. 073505	21.5	25	34	141	64.5	85	56	SOMX 073505	211,00 €
	ATUM 22XD3 SO.. 073505	22	25	34	144	66	88	56	SOMX 073505	211,00 €
	ATUM 22.5XD3 SO.. 073505	22.5	25	34	144	67.5	88	56	SOMX 073505	211,00 €
	ATUM 23XD3 SO.. 084005	23	25	34	147	69	91	56	SOMX 084005	211,00 €
	ATUM 23.5XD3 SO.. 084005	23.5	25	34	147	70.5	91	56	SOMX 084005	211,00 €
	ATUM 24XD3 SO.. 084005	24	25	34	150	72	94	56	SOMX 084005	219,00 €
	ATUM 24.5XD3 SO.. 084005	24.5	25	34	150	73.5	94	56	SOMX 084005	219,00 €
	ATUM 25XD3 SO.. 084005	25	25	34	153	75	97	56	SOMX 084005	219,00 €
	ATUM 26XD3 SO.. 084005	26	25	34	156	78	100	56	SOMX 084005	219,00 €
	ATUM 27XD3 SO.. 084005	27	25	34	159	81	103	56	SOMX 084005	219,00 €
	ATUM 28XD3 SO.. 094506	28	25	34	162	84	106	56	SOMX 094506	219,00 €
	ATUM 29XD3 SO.. 094506	29	25	34	165	87	109	56	SOMX 094506	219,00 €
	ATUM 30XD3 SO.. 094506	30	32	44	177	90	117	60	SOMX 094506	224,00 €
	ATUM 32XD3 SO.. 094506	32	32	44	183	96	123	60	SOMX 094506	243,00 €

U-DRILL SYSTEM / VOLLBOHRER (SOMX)

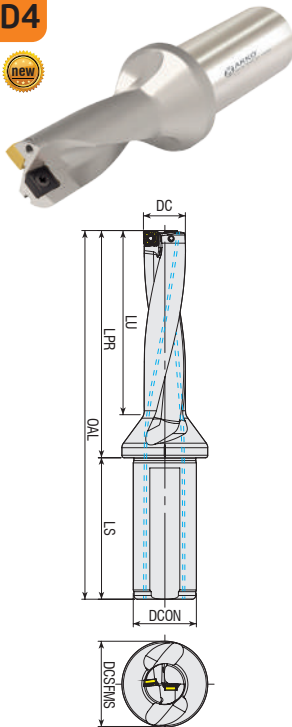
	CODE / TYP	TOOL DIMENSIONS (mm) <i>MAS</i>						CUTTING INSERT WENDE PLATTE	PRICE / PREIS	
		DC	DCON	DCSFMS	OAL	LU	LPR			LS
<p>D4</p>  <p>COMPATIBLE WITH MTSBH INSERT KOMPATIBEL FÜR MTSBH WENDESCHNEIDPLATTEN</p>	ATUM 14XD4 SO.. 052704	14	20	25	128	56	78	50	SOMX 052704	333,00 €
	ATUM 15XD4 SO.. 052704	15	20	25	132	60	82	50	SOMX 052704	333,00 €
	ATUM 16XD4 SO.. 052704	16	25	34	142	64	86	56	SOMX 052704	333,00 €
	ATUM 17XD4 SO.. 063005	17	25	34	146	68	90	56	SOMX 063005	333,00 €
	ATUM 18XD4 SO.. 063005	18	25	34	150	72	94	56	SOMX 063005	333,00 €
	ATUM 19XD4 SO.. 063005	19	25	34	154	76	98	56	SOMX 063005	333,00 €
	ATUM 20XD4 SO.. 073505	20	25	34	158	80	102	56	SOMX 073505	348,00 €
	ATUM 21XD4 SO.. 073505	21	25	34	162	84	106	56	SOMX 073505	348,00 €
	ATUM 22XD4 SO.. 073505	22	25	34	166	88	110	56	SOMX 073505	348,00 €
	ATUM 23XD4 SO.. 084005	23	25	34	170	92	114	56	SOMX 084005	363,00 €
	ATUM 24XD4 SO.. 084005	24	25	34	174	96	118	56	SOMX 084005	363,00 €
	ATUM 25XD4 SO.. 084005	25	25	34	178	100	122	56	SOMX 084005	363,00 €
	ATUM 26XD4 SO.. 084005	26	25	34	182	104	126	56	SOMX 084005	363,00 €
	ATUM 28XD4 SO.. 094506	28	25	34	190	112	134	56	SOMX 094506	363,00 €
	ATUM 30XD4 SO.. 094506	30	32	44	207	120	147	60	SOMX 094506	377,00 €

Ordering Example/Beispiel Bestellformular: 1pcs. ATUM 14XD2 SO.. 052704

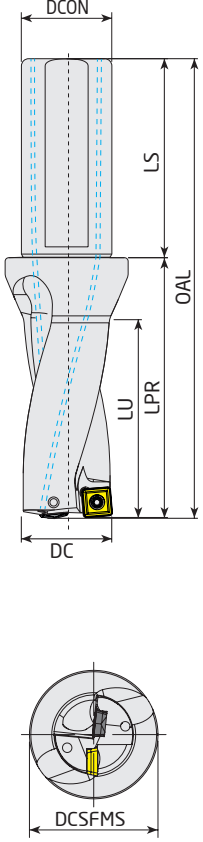
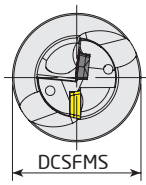

U-DRILL SYSTEM / VOLLBOHRER (SPMT - XOMT.)

D3	CODE / TYP	TOOL DIMENSIONS (mm) <i>MAß</i>							CUTTING INSERT WENDE PLATTE	PRICE / PREIS
		DC	DCON	DCSFMS	OAL	LU	LPR	LS		
  	ATUM 12.5XD3 KDR 0402..	12.5	20	25	108	36	58	50	SPMT 040204-XOMT 040204	184,00 €
	ATUM 13XD3 KDR 0402..	13	20	25	111	39	61	50	SPMT 040204-XOMT 040204	184,00 €
	ATUM 14XD3 KDR 0502..	14	20	25	114	42	64	50	SPMT 050204-XOMT 050204	184,00 €
	ATUM 14.5XD3 KDR 0502..	14.5	20	25	114	42	64	50	SPMT 050204-XOMT 050204	184,00 €
	ATUM 15XD3 KDR 0502..	15	20	25	117	45	67	50	SPMT 050204-XOMT 050204	184,00 €
	ATUM 15.5XD3 KDR 0502..	15.5	20	25	117	45	67	50	SPMT 050204-XOMT 050204	184,00 €
	ATUM 16XD3 KDR 0502..	16	25	34	126	48	70	56	SPMT 050204-XOMT 050204	184,00 €
	ATUM 16.5XD3 KDR 0602..	16.5	25	34	126	48	70	56	SPMT 060205-XOMT 060204	184,00 €
	ATUM 17XD3 KDR 0602..	17	25	34	129	51	73	56	SPMT 060205-XOMT 060204	184,00 €
	ATUM 17.5XD3 KDR 0602..	17.5	25	34	129	51	73	56	SPMT 060205-XOMT 060204	184,00 €
	ATUM 18XD3 KDR 0602..	18	25	34	132	54	76	56	SPMT 060205-XOMT 060204	184,00 €
	ATUM 18.5XD3 KDR 0602..	18.5	25	34	132	54	76	56	SPMT 060205-XOMT 060204	184,00 €
	ATUM 19XD3 KDR 0602..	19	25	34	135	57	79	56	SPMT 060205-XOMT 060204	184,00 €
	ATUM 19.5XD3 KDR 0602..	19.5	25	34	135	57	79	56	SPMT 060205-XOMT 060204	184,00 €
	ATUM 20XD3 KDR 07T2..	20	25	34	138	60	82	56	SPMT 07T208-XOMT 07T205	192,00 €
	ATUM 20.5XD3 KDR 07T2..	20.5	25	34	138	60	82	56	SPMT 07T208-XOMT 07T205	192,00 €
	ATUM 21XD3 KDR 07T2..	21	25	34	141	63	85	56	SPMT 07T208-XOMT 07T205	192,00 €
	ATUM 22XD3 KDR 07T2..	22	25	34	144	66	88	56	SPMT 07T208-XOMT 07T205	192,00 €
	ATUM 22.5XD3 KDR 07T2..	22.5	25	34	144	68	88	56	SPMT 07T208-XOMT 07T205	192,00 €
	ATUM 23XD3 KDR 07T2..	23	25	34	147	69	91	56	SPMT 07T208-XOMT 07T205	192,00 €
	ATUM 23.5XD3 KDR 07T2..	23.5	25	34	147	69	91	56	SPMT 07T208-XOMT 07T205	192,00 €
	ATUM 24XD3 KDR 0903..	24	25	34	150	72	94	56	SPMT 090308-XOMT 090305	198,00 €
	ATUM 24.5XD3 KDR 0903..	24.5	25	34	150	72	94	56	SPMT 090308-XOMT 090305	198,00 €
	ATUM 25XD3 KDR 0903..	25	25	34	153	75	97	56	SPMT 090308-XOMT 090305	198,00 €
	ATUM 26XD3 KDR 0903..	26	25	34	156	78	100	56	SPMT 090308-XOMT 090305	198,00 €
	ATUM 27XD3 KDR 0903..	27	25	34	159	81	103	56	SPMT 090308-XOMT 090305	198,00 €
	ATUM 28XD3 KDR 0903..	28	25	34	162	84	106	56	SPMT 090308-XOMT 090305	198,00 €
	ATUM 29XD3 KDR 0903..	29	25	34	165	87	109	56	SPMT 090308-XOMT 090305	198,00 €
	ATUM 30XD3 KDR 11T3..	30	32	44	177	90	117	60	SPMT 11T308-XOMT 11T306	204,00 €
	ATUM 32XD3 KDR 11T3..	32	32	44	183	96	123	60	SPMT 11T308-XOMT 11T306	204,00 €
	ATUM 33XD3 KDR 11T3..	33	32	44	186	99	126	60	SPMT 11T308-XOMT 11T306	204,00 €
	ATUM 34XD3 KDR 11T3..	34	32	44	189	102	129	60	SPMT 11T308-XOMT 11T306	204,00 €
	ATUM 35XD3 KDR 11T3..	35	32	44	192	105	132	60	SPMT 11T308-XOMT 11T306	204,00 €
	ATUM 37XD3 KDR 1304..	37	32	44	198	111	138	60	SPMT 130410-XOMT 130406	204,00 €
	ATUM 38XD3 KDR 1304..	38	32	44	201	114	141	60	SPMT 130410-XOMT 130406	204,00 €
	ATUM 39XD3 KDR 1304..	39	32	44	204	117	144	60	SPMT 130410-XOMT 130406	204,00 €
	ATUM 40XD3 KDR 1304..	40	32	44	207	120	147	60	SPMT 130410-XOMT 130406	204,00 €

COMPATIBLE WITH KRLY INSERT
KOMPATIBEL FÜR KRLY WENDESCHNEIDPLATTEN

D4	CODE / TYP	TOOL DIMENSIONS (mm) <i>MAß</i>							CUTTING INSERT WENDE PLATTE	PRICE / PREIS
		DC	DCON	DCSFMS	OAL	LU	LPR	LS		
	ATUM 14XD4 KDR 0502..	14	20	25	128	56	78	50	SPMT 050204-XOMT 050204	280,00 €
	ATUM 14.5XD4 KDR 0502..	14.5	20	25	128	56	78	50	SPMT 050204-XOMT 050204	280,00 €
	ATUM 15XD4 KDR 0502..	15	20	25	132	60	82	50	SPMT 050204-XOMT 050204	280,00 €
	ATUM 15.5XD4 KDR 0502..	15.5	20	25	132	60	82	50	SPMT 050204-XOMT 050204	280,00 €
	ATUM 16XD4 KDR 0502..	16	25	34	142	64	86	56	SPMT 050204-XOMT 050204	280,00 €
	ATUM 17XD4 KDR 0602..	17	25	34	146	68	90	56	SPMT 060205-XOMT 060204	280,00 €
	ATUM 17.5XD4 KDR 0602..	17.5	25	34	146	68	90	56	SPMT 060205-XOMT 060204	280,00 €
	ATUM 18XD4 KDR 0602..	18	25	34	150	72	94	56	SPMT 060205-XOMT 060204	280,00 €
	ATUM 18.5XD4 KDR 0602..	18.5	25	34	150	72	94	56	SPMT 060205-XOMT 060204	280,00 €
	ATUM 19XD4 KDR 0602..	19	25	34	154	76	98	56	SPMT 060205-XOMT 060204	280,00 €
	ATUM 20XD4 KDR 07T2..	20	25	34	158	80	102	56	SPMT 07T208-XOMT 07T205	292,00 €
	ATUM 21XD4 KDR 07T2..	21	25	34	162	84	106	56	SPMT 07T208-XOMT 07T205	292,00 €
	ATUM 22XD4 KDR 07T2..	22	25	34	166	88	110	56	SPMT 07T208-XOMT 07T205	292,00 €
	ATUM 24XD4 KDR 0903..	24	25	34	174	96	118	56	SPMT 090308-XOMT 090305	305,00 €
	ATUM 25XD4 KDR 0903..	25	25	34	178	100	122	56	SPMT 090308-XOMT 090305	305,00 €

COMPATIBLE WITH KRLY INSERT
KOMPATIBEL FÜR KRLY WENDESCHNEIDPLATTEN

U-DRILL SYSTEM / VOLLBOHRER (SOMT)

	CODE / TYP	TOOL DIMENSIONS (mm) <small>MAß</small>							CUTTING INSERT <small>WENDE PLATTE</small>	PRICE / PREIS
		DC	DCON	DCSFMS	OAL	LU	LPR	LS		
 <p>COMPATIBLE WITH TGTC INSERT KOMPATIBEL FÜR TGTC WENDESCHNEIDPLATTEN</p>	ATUM 14XD2 SOMT 050204	14	20	25	100	28	50	50	SOMT 050204	172,00 €
	ATUM 16XD2 SOMT 050204	16	25	34	110	32	54	56	SOMT 050204	172,00 €
	ATUM 17XD2 SOMT 060204	17	25	34	112	34	56	56	SOMT 060204	172,00 €
	ATUM 18XD2 SOMT 060204	18	25	34	114	36	58	56	SOMT 060204	172,00 €
	ATUM 20XD2 SOMT 070306	20	25	34	118	40	62	56	SOMT 070306	184,00 €
	ATUM 22XD2 SOMT 070306	22	25	34	122	44	66	56	SOMT 070306	184,00 €
	ATUM 23XD2 SOMT 08T306	23	25	34	124	46	68	56	SOMT 08T306	184,00 €
	ATUM 24XD2 SOMT 08T306	24	25	34	126	48	70	56	SOMT 08T306	192,00 €
	ATUM 25XD2 SOMT 08T306	25	25	34	128	50	72	56	SOMT 08T306	192,00 €
	ATUM 26XD2 SOMT 08T306	26	25	34	130	52	74	56	SOMT 08T306	192,00 €
	ATUM 27XD2 SOMT 09T308	27	25	34	132	54	76	56	SOMT 09T308	192,00 €
	ATUM 28XD2 SOMT 09T308	28	25	34	134	56	78	56	SOMT 09T308	192,00 €
	ATUM 29XD2 SOMT 09T308	29	25	34	136	58	80	56	SOMT 09T308	192,00 €
	ATUM 30XD2 SOMT 09T308	30	32	44	147	60	87	60	SOMT 09T308	204,00 €
	ATUM 32XD2 SOMT 11T308	32	32	44	151	64	91	60	SOMT 11T308	204,00 €
	ATUM 33XD2 SOMT 11T308	33	32	44	153	66	93	60	SOMT 11T308	204,00 €
	ATUM 34XD2 SOMT 11T308	34	32	44	155	68	95	60	SOMT 11T308	204,00 €
	ATUM 35XD2 SOMT 11T308	35	32	44	157	70	97	60	SOMT 11T308	204,00 €
	ATUM 37XD2 SOMT 130408	37	32	44	161	74	101	60	SOMT 130408	204,00 €
	ATUM 38XD2 SOMT 130408	38	32	44	163	76	103	60	SOMT 130408	204,00 €
ATUM 40XD2 SOMT 130408	40	32	44	167	80	107	60	SOMT 130408	204,00 €	
ATUM 45XD2 SOMT 150510	45	40	54	192	90	122	70	SOMT 150510	231,00 €	
ATUM 47XD2 SOMT 150510	47	40	54	196	94	126	70	SOMT 150510	263,00 €	

User's Guide For U-Drills : P 166 / Bedienungsanleitung für U-Bohrer: S 166

Ordering Example/Beispiel Bestellformular: 1pcs. ATUM 14XD2 SOMT 050204



U-DRILL SYSTEM / VOLLBOHRER (SOMT.)

	CODE / TYP	TOOL DIMENSIONS (mm) Maß							CUTTING INSERT WENDE PLATTE	PRICE / PREIS
		DC	DCON	DCSFMS	OAL	LU	LPR	LS		
 <p>COMPATIBLE WITH TGTC INSERT KOMPATIBEL FÜR TGTC WENDESCHNEIDPLATTEN</p>	ATUM 14XD5 SOMT 050204	14	20	25	142	70	92	50	SOMT 050204	275,00 €
	ATUM 15XD5 SOMT 050204	15	20	25	147	75	97	50	SOMT 050204	275,00 €
	ATUM 15.5XD5 SOMT 050204	15.5	20	25	147	75	97	50	SOMT 050204	297,00 €
	ATUM 16XD5 SOMT 050204	16	25	34	158	80	102	56	SOMT 050204	275,00 €
	ATUM 16.5XD5 SOMT 060204	16.5	25	34	158	80	102	56	SOMT 060204	275,00 €
	ATUM 17.5XD5 SOMT 060204	17	25	34	163	85	107	56	SOMT 060204	275,00 €
	ATUM 18XD5 SOMT 060204	18	25	34	168	90	112	56	SOMT 060204	275,00 €
	ATUM 18.5XD5 SOMT 060204	18.5	25	34	168	90	112	56	SOMT 060204	275,00 €
	ATUM 19XD5 SOMT 060204	19	25	34	173	95	117	56	SOMT 060204	275,00 €
	ATUM 19.5XD5 SOMT 070306	19.5	25	34	173	95	117	56	SOMT 070306	275,00 €
	ATUM 20XD5 SOMT 070306	20	25	34	178	100	122	56	SOMT 070306	286,00 €
	ATUM 21XD5 SOMT 070306	21	25	34	183	105	127	56	SOMT 070306	286,00 €
	ATUM 22XD5 SOMT 070306	22	25	34	188	110	132	56	SOMT 070306	286,00 €
	ATUM 23XD5 SOMT 08T306	23	25	34	193	115	137	56	SOMT 08T306	286,00 €
	ATUM 24XD5 SOMT 08T306	24	25	34	198	120	142	56	SOMT 08T306	297,00 €
	ATUM 25XD5 SOMT 08T306	25	25	34	203	125	147	56	SOMT 08T306	297,00 €
	ATUM 26XD5 SOMT 08T306	26	25	34	208	130	152	56	SOMT 08T306	297,00 €
	ATUM 27XD5 SOMT 09T308	27	25	34	213	135	157	56	SOMT 09T308	297,00 €
	ATUM 28XD5 SOMT 09T308	28	25	34	218	140	162	56	SOMT 09T308	297,00 €
	ATUM 29XD5 SOMT 09T308	29	25	34	223	145	167	56	SOMT 09T308	297,00 €
ATUM 30XD5 SOMT 09T308	30	32	44	237	150	177	60	SOMT 09T308	306,00 €	
ATUM 33XD5 SOMT 11T308	33	32	44	252	165	192	60	SOMT 11T308	306,00 €	
ATUM 34XD5 SOMT 11T308	34	32	44	257	170	197	60	SOMT 11T308	306,00 €	
ATUM 35XD5 SOMT 11T308	35	32	44	262	175	202	60	SOMT 11T308	306,00 €	
ATUM 36XD5 SOMT 11T308	36	32	44	267	180	207	60	SOMT 11T308	306,00 €	

User's Guide For U-Drills : P 166 / Bedienungsanleitung für U-Bohrer: S 166

Ordering Example/Beispiel Bestellformular: 1pcs. ATUM 14XD5 SOMT 050204

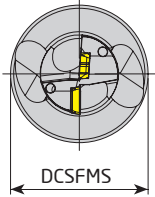

U-DRILL SYSTEM / VOLLBOHRER (880.)

	CODE / TYP	TOOL DIMENSIONS (mm) <i>MAB</i>						CUTTING INSERT WENDE PLATTE	PRICE / PREIS	
		DC	DCON	DCSFMS	OAL	LU	LPR			LS
   COMPATIBLE WITH SNDVK INSERT KOMPATIBEL FÜR SNDVK WENDESCHNEIDPLATTEN	D3 ATUM 14XD3 880-0202..	14	20	25	108	45	58	50	880-02...C / P	202,00 €
	ATUM 14.5XD3 880-0202..	14.5	20	25	110	46	60	50	880-02...C / P	202,00 €
	ATUM 15XD3 880-0202..	15	20	25	112	48	62	50	880-02...C / P	202,00 €
	ATUM 15.5XD3 880-0202..	15.5	20	25	114	50	64	50	880-02...C / P	202,00 €
	ATUM 16XD3 880-0202..	16	20	25	116	51	66	50	880-02...C / P	202,00 €
	ATUM 16.5XD3 880-0303..	16.5	20	25	118	53	68	50	880-03...C / P	202,00 €
	ATUM 17XD3 880-0303..	17	20	25	119	54	69	50	880-03...C / P	202,00 €
	ATUM 17.5XD3 880-0303..	17.5	25	32	128	56	72	56	880-03...C / P	202,00 €
	ATUM 18XD3 880-0303..	18	25	32	129	57	73	56	880-03...C / P	202,00 €
	ATUM 18.5XD3 880-0303..	18.5	25	32	131	59	75	56	880-03...C / P	202,00 €
	ATUM 19XD3 880-0303..	19	25	32	132	60	76	56	880-03...C / P	202,00 €
	ATUM 19.5XD3 880-0303..	19.5	25	32	135	62	79	56	880-03...C / P	202,00 €
	ATUM 20XD3 880-0403..	20	25	32	137	64	81	56	880-04...C / P	210,00 €
	ATUM 20.5XD3 880-0403..	20.5	25	32	138	65	82	56	880-04...C / P	210,00 €
	ATUM 21XD3 880-0403..	21	25	32	140	66	84	56	880-04...C / P	210,00 €
	ATUM 21.5XD3 880-0403..	22	25	32	142	68	86	56	880-04...C / P	210,00 €
	ATUM 22XD3 880-0403..	23	25	32	143	69	87	56	880-04...C / P	210,00 €
	ATUM 22.5XD3 880-0403..	22.5	25	32	146	71	90	56	880-04...C / P	210,00 €
	ATUM 23XD3 880-0403..	23	25	32	147	72	91	56	880-04...C / P	210,00 €
	ATUM 23.5XD3 880-0403..	23.5	23	34	149	69	93	56	880-04...C / P	210,00 €
	ATUM 24XD3 880-0503..	24	25	32	151	76	95	56	880-05...C / P	218,00 €
	ATUM 25XD3 880-0503..	25	25	32	155	79	99	56	880-05...C / P	218,00 €
	ATUM 26XD3 880-0503..	26	32	44	162	81	102	60	880-05...C / P	218,00 €
	ATUM 27XD3 880-0503..	27	32	44	165	84	105	60	880-05...C / P	218,00 €
	ATUM 28XD3 880-0503..	28	32	44	169	87	109	60	880-05...C / P	218,00 €
	ATUM 29XD3 880-0503..	29	32	44	172	90	112	60	880-05...C / P	218,00 €
	ATUM 30XD3 880-0604..	30	32	44	177	94	117	60	880-06...C / P	224,00 €
	ATUM 31XD3 880-0604..	31	40	54	191	97	121	70	880-06...C / P	224,00 €
	ATUM 32XD3 880-0604..	32	40	54	194	100	124	70	880-06...C / P	224,00 €
	ATUM 33XD3 880-0604..	33	40	54	198	103	128	70	880-06...C / P	224,00 €
	ATUM 34XD3 880-0604..	34	40	54	201	106	131	70	880-06...C / P	224,00 €
	ATUM 35XD3 880-0604..	35	40	54	205	109	135	70	880-06...C / P	224,00 €
ATUM 36XD3 880-0704..	36	40	54	209	112	139	70	880-07...C / P	224,00 €	
ATUM 38XD3 880-0704..	38	40	54	216	118	146	70	880-07...C / P	224,00 €	
ATUM 39XD3 880-0704..	39	40	54	219	121	149	70	880-07...C / P	224,00 €	
ATUM 40XD3 880-0704..	40	40	54	223	124	153	70	880-07...C / P	224,00 €	
ATUM 41XD3 880-0704..	41	40	54	227	127	157	70	880-07...C / P	247,00 €	
ATUM 42XD3 880-0704..	42	40	54	230	130	160	70	880-07...C / P	247,00 €	
ATUM 45XD3 880-0805..	45	40	54	242	140	172	70	880-08...C / P	260,00 €	
ATUM 46XD3 880-0805..	46	40	54	246	143	176	70	880-08...C / P	275,00 €	
ATUM 48XD3 880-0805..	48	40	54	253	149	183	70	880-08...C / P	305,00 €	
ATUM 50XD3 880-0805..	50	40	54	260	155	190	70	880-08...C / P	347,00 €	

EXCENTRIC ADAPTOR FOR U-DRILLS / EXZENTRISCHER ADAPTER FÜR WENDEPLATTENBOHRER

	CODE / TYP	TOOL DIMENSIONS (mm) <i>MAB</i>			PRICE / PREIS
		DCON	BD	LF	
	AET-2025	20	25	44	85,00 €
	AET-2532	25	32	46	85,00 €
	AET-3240	32	40	55	85,00 €
CAN BE ADJUSTABLE BETWEEN		ZWISCHEN -0,2 mm UND +0,4 mm EINSTELLBAR			
Ø+0,4 - Ø-0,2 AS DECIMAL		BEISPIEL WERKZEUG :			
FOR EXAMPLE: Ø25 TOOL;		Ø25= WERKZEUG ZWISCHEN 24,80≈25,4 EINSTELLBAR			
CAN BE ADJUSTABLE BETWEEN 24,80≈25,4					

DRILL CHAMFERING RING TOOLS / VOLLBOHRER RING FASENFRÄSER

	CODE / TYP	COMPATIBLE ATUM DIAMETER	CUTTING INSERT WENDE PLATTE	PRICE / PREIS
 <p>45°</p>	ADCR-120-VB1103	12.5	VBM. 1103..	93,00 €
	ADCR-125-VB1103	13	VBM. 1103..	93,00 €
	ADCR-130-VB1103	13.5	VBM. 1103..	93,00 €
	ADCR-135-VB1103	14	VBM. 1103..	93,00 €
	ADCR-140-VB1103	14.5	VBM. 1103..	93,00 €
	ADCR-145-VB1103	15	VBM. 1103..	93,00 €
	ADCR-150-VB1103	15.5-16	VBM. 1103..	93,00 €
	ADCR-155-VB1103	16.5	VBM. 1103..	93,00 €
	ADCR-160-VB1103	17	VBM. 1103..	98,00 €
	ADCR-165-VB1103	17.5	VBM. 1103..	98,00 €
	ADCR-170-VB1103	18	VBM. 1103..	98,00 €
	ADCR-175-VB1103	18.5	VBM. 1103..	98,00 €
	ADCR-180-VB1103	19	VBM. 1103..	98,00 €
	ADCR-185-VB1103	19.5	VBM. 1103..	98,00 €
	ADCR-190-VB1103	20	VBM. 1103..	98,00 €
	ADCR-195-VB1103	20.5	VBM. 1103..	98,00 €
	ADCR-200-VB1103	21	VBM. 1103..	102,00 €
	ADCR-205-VB1103	21.5	VBM. 1103..	102,00 €
	ADCR-210-VB1103	22	VBM. 1103..	102,00 €
	ADCR-215-VB1103	22.5	VBM. 1103..	102,00 €
	ADCR-220-VB1103	23	VBM. 1103..	102,00 €
	ADCR-225-VB1103	23.5	VBM. 1103..	102,00 €
	ADCR-230-VB1103	24	VBM. 1103..	102,00 €
	ADCR-235-VB1103	24.5	VBM. 1103..	102,00 €
	ADCR-240-VB1103	25	VBM. 1103..	102,00 €
	ADCR-245-VB1103	25.5	VBM. 1103..	102,00 €
	ADCR-250-VB1103	26	VBM. 1103..	111,00 €
	ADCR-255-VB1103	26.5	VBM. 1103..	111,00 €
	ADCR-260-VB1103	27	VBM. 1103..	111,00 €
	ADCR-265-VB1103	27.5	VBM. 1103..	111,00 €
	ADCR-270-VB1103	28	VBM. 1103..	111,00 €
	ADCR-275-VB1103	28.5	VBM. 1103..	111,00 €
	ADCR-280-VB1103	29	VBM. 1103..	111,00 €
ADCR-285-VB1103	29.5	VBM. 1103..	111,00 €	
ADCR-290-VB1103	30	VBM. 1103..	111,00 €	
ADCR-295-VB1103	30.5	VBM. 1103..	111,00 €	
ADCR-300-VB1103	31	VBM. 1103..	111,00 €	

DRILLING, BORING and EXTERNAL TURNING / MULTIFUNKTIONALES DREH-UND BOHRWERKZEUG

	CODE / TYP	TOOL DIMENSIONS (mm) MAß							CUTTING INSERT WENDE PLATTE	PRICE / PREIS
		DC	DCON	DCSFMS	LU	LPR	LS	WF		
 <p>COMPATIBLE WITH CRTZT-ISCRTGTC-KRLY INSERT KOMPATIBEL FÜR CRTZT-ISCRTGTC-KRLY WENDESCHNEIDPLATTEN</p>	AEKR/L-D2.25X8 XC.. 040104	8	10	12	18	22	38	4	XC.. 040104	131,00 €
	AEKR/L-D2.25X10 XC.. 050204	10	12	16	22.5	27.5	42	5	XC.. 050204	131,00 €
	AEKR/L-D2.25X12 XC.. 060204	12	16	20	27	33	45	6	XC.. 060204	139,00 €
	AEKR/L-D2.25X14 XC.. 070304	14	16	20	31.5	38	45	7	XC.. 070304	144,00 €
	AEKR/L-D2.25X16 XC.. 080304	16	20	25	36	44	50	8	XC.. 080304	151,00 €
	AEKR/L-D2.25X18 XC.. 09T304	18	25	32	40.5	50	56	9	XC.. 09T304	169,00 €
	AEKR/L-D2.25X20 XC.. 10T304	20	25	32	45	55	56	10	XC.. 10T304	185,00 €
	AEKR/L-D2.25X25 XC.. 130404	25	32	40	56.5	69	60	12.5	XC.. 130404	210,00 €
	AEKR/L-D2.25X32 XC.. 170504	32	40	50	72	88	70	16	XC.. 170504	216,00 €

ADJUSTABLE FINISH BORING HEADS / EINSTELLBARE BOHRKÖPFE

	CODE / TYP	TOOL DIMENSIONS (mm) MAß							CARTRIDGE KURZDREHHALTER	CUTTING INSERT WENDE PLATTE	PRICE / PREIS
		DCN-DCX	LF	LPR	LS	DCON	DCONMS	KAPR			
	SET-ABHF-D06X30-WA25	06-30	67	45	56	25	55	95°	SWLCR-D06X10-22	WGT020104L	
		06-30	75	45	56	25	55	95°	SWLCR-D08X14-30	WGT020104L	
		06-30	85	45	56	25	55	93°	STUPR-D12X18-40	TPGX 090202L	
		06-30	85	45	56	25	55	93°	STUPR-D16X22-40	TPGX 090202L	1.059,00 €
		06-30	85	45	56	25	55	93°	STUPR-D20X26-40	TPGX 090202L	
		06-30	95	45	56	25	55	93°	STUPR-D24X30-50	TPGX 090202L	
	SET-ABHF-D29X40-WA16	29-40	50	46	40	16	27	-	STFPR-D29x35	TPGX 090202L	
		29-40	50	46	40	16	27	-	STFPR-D34x40	TPGX 090202L	611,00 €
	SET-ABHF-D39X54-WA20	39-54	60	55	50	20	36	-	STFPR-D39x47	TPGX 090202L	
		39-54	60	55	50	20	36	-	STFPR-D46x54	TPGX 090202L	659,00 €
	SET-ABHF-D52X80-WA25	52-80	70	65	56	25	48	-	STFPR-D52x68	TPGX 090202L	
		52-80	70	65	56	25	48	-	STFPR-D64x80	TPGX 090202L	729,00 €
SET-ABHF-D78X170-WA32	78-170	83	77	60	32	70	-	STFPR-D78x98	TPGX 090202L		
	78-170	83	77	60	32	70	-	STFPR-D96x116	TPGX 090202L	951,00 €	

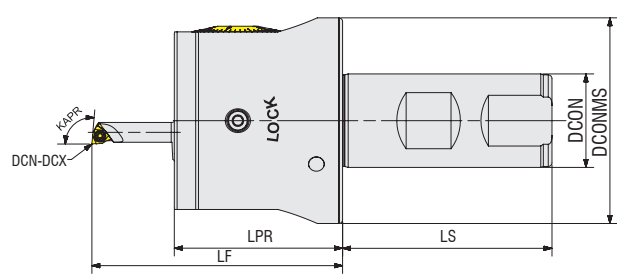

ADJUSTABLE FINISH BORING HEADS / EINSTELLBARE BOHRKÖPFE

	CODE / TYP	TOOL DIMENSIONS (mm) MAß					PRICE / PREIS
		DC DCX	LPR	LS	DCON	DCONMS	
	ABHF-D06X30-WA25	06-30	45	56	25	55	719,00 €
	ABHF-D29X40-WA16	29-40	46	40	16	27	519,00 €
	ABHF-D39X54-WA20	39-54	55	50	20	36	573,00 €
	ABHF-D52X80-WA25	52-80	65	56	25	48	611,00 €
	ABHF-D78X170-WA32	78-170	77	60	32	72	692,00 €

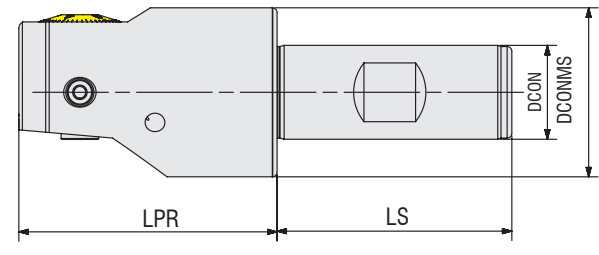

FINISH BORING HEADS CARTRIDGE / FERTIGBOHRKÖPFE UND KARTUSCHEN

	CODE / TYP	TOOL DIMENSIONS (mm) MAß						CUTTING INSERT WENDE PLATTE	PRICE / PREIS
		DCN	WF	KAPR	LF	OHN	DCON		
	SWLCR-D06X10-22	6	3	95°	47	22	12	WCGT020104L	58,00 €
	SWLCR-D08X14-30	8	4	95°	55	30	12	WCGT020104L	58,00 €

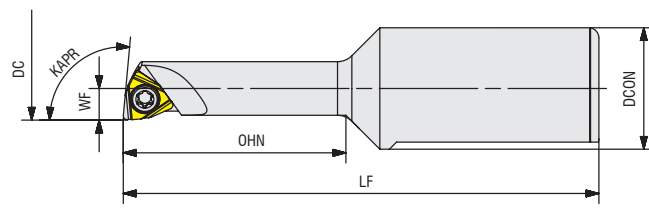

FINISH BORING HEADS CARTRIDGE / FERTIGBOHRKÖPFE UND KARTUSCHEN

	CODE / TYP	TOOL DIMENSIONS (mm) <small>MAB</small>					CUTTING INSERT <small>WENDE PLATTE</small>	PRICE / PREIS
		DCN	WF	KAPR	LF	OHN		
	STUPR-D12X18-40	12	6	93°	65	40	12	62,00 €
	STUPR-D16X22-40	16	8	93°	65	40	12	62,00 €
	STUPR-D20X26-40	20	10	93°	65	40	12	70,00 €
	STUPR-D24X30-50	24	12	93°	75	50	12	70,00 €

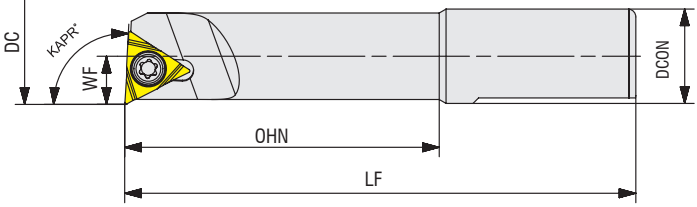

FINISH BORING HEADS CARTRIDGE / FERTIGBOHRKÖPFE UND KARTUSCHEN

	CODE / TYP	TOOL DIMENSIONS (mm) <small>MAB</small>			CUTTING INSERT <small>WENDE PLATTE</small>	PRICE / PREIS
		WF	KAPR	LF		
	STFPR-D29x35	10	90°	21.90	TPGX 090202L	53,00 €
	STFPR-D34x40	12.50	90°	21.90	TPGX 090202L	53,00 €
	STFPR-D39x47	12	90°	26.90	TPGX 090202L	54,00 €
	STFPR-D46x54	15.50	90°	26.90	TPGX 090202L	54,00 €
	STFPR-D52x68	14	90°	34.90	TPGX 090202L	71,00 €
	STFPR-D64x80	20	90°	34.90	TPGX 090202L	71,00 €
	STFPR-D78x98	20	90°	44.90	TPGX 090202L	71,00 €
	STFPR-D96x116	29	90°	44.90	TPGX 090202L	71,00 €

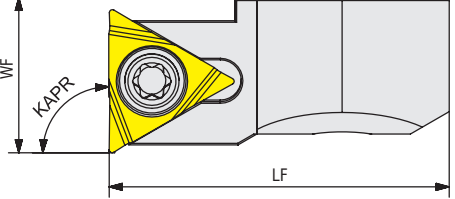

FINISH BORING HEADS CARTRIDGE / FERTIGBOHRKÖPFE UND KARTUSCHEN

	CODE / TYP	TOOL DIMENSIONS (mm) <small>MAB</small>			PRICE / PREIS
		DCON	LF	LS	
	AEA-114x134	31.80	12.90	9	71,00 €
	AEA-132x152	31.80	21.90	18	71,00 €

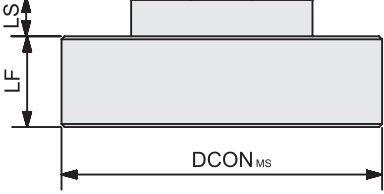

ROUGH BORING HEADS / SCHRUPP-SPINDELKOPF

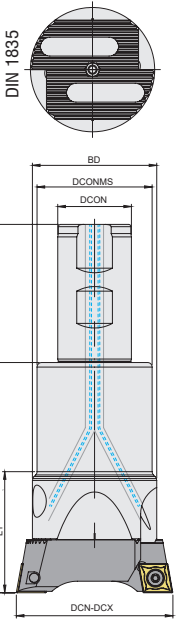
	CODE / TYP	TOOL DIMENSIONS (mm) <i>MAß</i>							CARTRIDGE KURZDREHHALTER	PRICE / PREIS
		DCN-DCX	DCON	DCONMS	BD	OAL	LF	L1		
 	ABHR-D18x22-W16-L90-CC06	18-22	16	-	-	90	42	-	AK.. 18-22	310,00 €
	ABHR-D18x22-W16-L150-CC06	18-22	16	-	-	150	102	-	AK.. 18-22	370,00 €
	ABHR-D18x22-W16-L200-CC06	18-22	16	-	-	200	152	-	AK.. 18-22	465,00 €
	ABHR-D22x28-W20-L100-CC06	22-28	20	-	-	100	50	-	AK.. 22-28	321,00 €
	ABHR-D22x28-W20-L150-CC06	22-28	20	-	-	150	100	-	AK.. 22-28	388,00 €
	ABHR-D22x28-W20-L200-CC06	22-28	20	-	-	200	150	-	AK.. 22-28	483,00 €
	ABHR-D28x38-W20-L110-CC06	28-38	20	25	-	110	60	-	AK.. 28-38	329,00 €
	ABHR-D28x38-W20-L160-CC06	28-38	20	25	-	160	110	-	AK.. 28-38	394,00 €
	ABHR-D28x38-W20-L230-CC06	28-38	20	25	-	230	180	-	AK.. 28-38	494,00 €
	ABHR-D36x50-W25-L120-CC06	36-50	25	32	-	120	64	-	AK.. 36-50	334,00 €
	ABHR-D36x50-W25-L170-CC06	36-50	25	32	-	170	114	-	AK.. 36-50	400,00 €
	ABHR-D36x50-W25-L250-CC06	36-50	25	32	-	250	194	-	AK.. 36-50	501,00 €
	ABHR-D36x50-W25-L120-CC09	36-50	25	32	-	120	64	-	AK.. 36-50-09	334,00 €
	ABHR-D36x50-W25-L170-CC09	36-50	25	32	-	170	114	-	AK.. 36-50-09	400,00 €
	ABHR-D36x50-W25-L250-CC09	36-50	25	32	-	250	194	-	AK.. 36-50-09	501,00 €
	ABHR-D50x68-W32-L140-CC09	50-68	32	40	-	140	80	-	AK.. 50-68	346,00 €
	ABHR-D50x68-W32-L200-CC09	50-68	32	40	-	200	140	-	AK.. 50-68	417,00 €
	ABHR-D50x68-W32-L280-CC09	50-68	32	40	-	280	220	-	AK.. 50-68	519,00 €
	ABHR-D50x68-W32-L140-CC12	50-68	32	40	-	140	80	-	AK.. 50-68-12	346,00 €
	ABHR-D50x68-W32-L200-CC12	50-68	32	40	-	200	140	-	AK.. 50-68-12	417,00 €
	ABHR-D50x68-W32-L280-CC12	50-68	32	40	-	280	220	-	AK.. 50-68-12	519,00 €
	ABHR-D68x90-W32-L160-CC12	68-90	32	50	54	160	100	50	AK.. 68-90	382,00 €
	ABHR-D68x90-W32-L210-CC12	68-90	32	50	54	210	150	50	AK.. 68-90	459,00 €
	ABHR-D68x90-W32-L280-CC12	68-90	32	50	54	280	220	50	AK.. 68-90	573,00 €
	ABHR-D90x120-W32-L140-CC12	90-120	32	63	72	140	80	63	AK.. 90-120	417,00 €
	ABHR-D90x120-W40-L200-CC12	90-120	40	63	72	200	130	63	AK.. 90-120	454,00 €
	ABHR-D90x120-W40-L300-CC12	90-120	40	63	72	300	230	63	AK.. 90-120	543,00 €
	ABHR-D120x160-W40-L210-CC12	120-160	40	80	95	210	140	75	AK.. 120-160	714,00 €
ABHR-D120x160-W40-L300-CC12	120-160	40	80	95	300	230	75	AK.. 120-160	857,00 €	
ABHR-D160x200-W40-L210-B-CC12	160-200	40	80	95	210	140	75	AK.. 160-800	726,00 €	
ABHR-D160x200-W40-L300-B-CC12	160-200	40	80	95	300	230	75	AK.. 160-800	869,00 €	

ADJUSTABLE ROUGH BORING HEADS BODY / TRÄGERWERKZEUG FÜR EINSTELLBARE SCHRUPP-BOHRKÖPFE

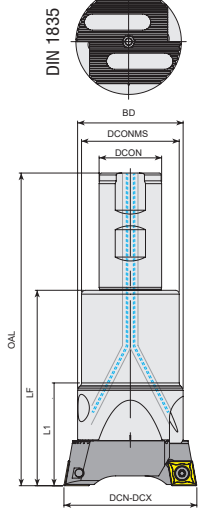
	CODE / TYP	TOOL DIMENSIONS (mm) <i>MAß</i>							CARTRIDGE KURZDREHHALTER	PRICE / PREIS
		DCN-DCX	DCON	DCONMS	BD	OAL	LF	L1		
 	ABHRS-D16x42-W16-L90	18-22	16	-	-	90	42	-	AK.. 18-22	144,00 €
	ABHRS-D16x102-W16-L150	18-22	16	-	-	150	102	-	AK.. 18-22	204,00 €
	ABHRS-D16x152-W16-L200	18-22	16	-	-	200	152	-	AK.. 18-22	300,00 €
	ABHRS-D20x50-W20-L100	22-28	20	-	-	100	50	-	AK.. 22-28	142,00 €
	ABHRS-D20x100-W20-L150	22-28	20	-	-	150	100	-	AK.. 22-28	209,00 €
	ABHRS-D20x150-W20-L200	22-28	20	-	-	200	150	-	AK.. 28-38	303,00 €
	ABHRS-D25x60-W20-L110	28-38	20	25	-	110	60	-	AK.. 28-38	138,00 €
	ABHRS-D25x110-W20-L160	28-38	20	25	-	160	110	-	AK.. 28-38	202,00 €
	ABHRS-D25x180-W20-L230	28-38	20	25	-	230	180	-	AK.. 28-38	303,00 €
	ABHRS-D32X64-W25-L120	36-50	25	32	-	120	64	-	AK.. 36-50	131,00 €
	ABHRS-D32X114-W25-L170	36-50	25	32	-	170	114	-	AK.. 36-50	197,00 €
	ABHRS-D32X194-W25-L250	36-50	25	32	-	250	194	-	AK.. 36-50	297,00 €
	ABHRS-D40x80-W32-L140	50-68	32	40	-	140	80	-	AK.. 50-68	131,00 €
	ABHRS-D40x140-W32-L200	50-68	32	40	-	200	140	-	AK.. 50-68	202,00 €
	ABHRS-D40x220-W32-L280	50-68	32	40	-	280	220	-	AK.. 50-68	304,00 €
	ABHRS-D50x100-W32-L160	68-90	32	50	54	160	100	50	AK.. 68-90	155,00 €
	ABHRS-D50x150-W32-L210	68-90	32	50	54	210	150	50	AK.. 68-90	233,00 €
	ABHRS-D50x220-W32-L280	68-90	32	50	54	280	220	50	AK.. 68-90	346,00 €
	ABHRS-D63x80-W32-L140	90-120	32	63	72	140	80	63	AK.. 90-120	180,00 €
	ABHRS-D63x130-W40-L200	90-120	40	63	72	200	130	63	AK.. 90-120	215,00 €
	ABHRS-D63x230-W40-L300	90-120	40	63	72	300	230	63	AK.. 90-120	304,00 €
	ABHRS-D80x140-W40-L210	120-160	40	80	95	210	140	75	AK.. 120-160	465,00 €
	ABHRS-D80x230-W40-L300	120-160	40	80	95	300	230	75	AK.. 120-160	607,00 €
	ABHRS-D80x140-W40-L210	160-200	40	80	95	210	140	75	AK.. 160-800	465,00 €
	ABHRS-D80x230-W40-L300	160-200	40	80	95	300	230	75	AK.. 160-800	607,00 €

When ordered, body and cartridge will be sent as set.

Ordering Example/Beispiel Bestellformular: 1pcs. ABHR-D18x22-W16-L90-CC06

ROUGH BORING HEADS CARTRIDGE / SCHRUPP-SPINDELKOPF KURZDREHHALTER

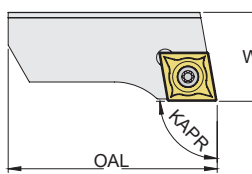
	CODE / TYP	TOOL DIMENSIONS (mm) MAB			CUTTING INSERT WENDE PLATTE	PRICE / PREIS
		Dmin / Dmax	WF	OAL		
 	AKSR 18-22	18-22	9	15	CC.. 0602..	84,00 €
	AKSR 22-28	22-28	10	19	FOR ISO	91,00 €
	AKSR 28-38	28-38	13	23	INSERT.	97,00 €
	AKSR 36-50	36-50	16	32		102,00 €
	AKSR 36-50-09	36-50	16	32	CC.. 09T3..	102,00 €
	AKSR 50-68	50-68	20	40	FOR ISO INSERT.	108,00 €
	AKSR 50-68-12	50-68	20	40		108,00 €
	AKSR 68-90	68-90	23	54	CC.. 1204..	114,00 €
	AKSR 90-120	90-120	28	70	FOR ISO	120,00 €
	AKSR 120-160	120-160	33	95	INSERT.	160,00 €
AKSR 160-200	160-800	33	130		131,00 €	

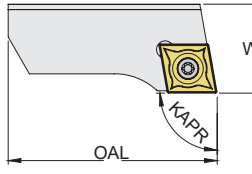
	CODE / TYP	TOOL DIMENSIONS (mm) MAB			CUTTING INSERT WENDE PLATTE	PRICE / PREIS
		Dmin / Dmax	WF	OAL		
 	AKCR 28-38	28-38	12.8	23	CC.. 0602..	97,00 €
	AKCR 36-50	36-50	15.8	32	FOR ISO INSERT.	102,00 €
	AKCR 36-50-09	36-50	15.8	32	CC.. 09T3..	102,00 €
	AKCR 50-68	50-68	19.7	40	FOR ISO INSERT.	108,00 €
	AKCR 50-68-12	50-68	19.7	40	CC.. 1204..	108,00 €
	AKCR 68-90	68-90	22.7	54	FOR ISO INSERT.	114,00 €
	AKCR 90-120	90-120	27.7	70		120,00 €
	AKCR 120-160	120-160	32.7	95		126,00 €
	AKCR 160-200	160-800	32.7	130		131,00 €



HELIX CHAMFER MILLING TOOLS / HELIX-FASFRÄSE

	CODE / TYP	ZEFP		TOOL DIMENSIONS (mm) MAB						PRICE / PREIS
		Total	Effective	KAPR	DC	DCX	DCON	APMX	LF	
	AHM15-AP16-D35x93-A27-Z0306-H	6	3	15	35	93	27	8	50	378,00 €
	AHM30-AP16-D35x87-A27-Z0306-H	6	3	30	35	87	27	15	50	378,00 €
	AHM45-AP16-D35x77-A27-Z0306-H	6	3	45	35	77	27	21.5	50	378,00 €
	AHM60-AP16-D35x65-A22-Z0306-H	6	3	60	35	65	22	26.5	50	378,00 €
	AHM75-AP16-D35x50-A22-Z0306-H	6	3	75	35	50	22	29.5	50	378,00 €

**COUNTERSINK MILLING TOOL FOR CYLINDRICAL ALLEN HEAD SCREWS (DIN 974-1)
SENKWERKZEUG FÜR ZYLINDERKOPFSCHRAUBEN (DIN 974-1)**

	CODE / TYP	TOOL DIMENSIONS (mm) MAB						PRICE / PREIS
		DC	DCX	DCON	LH	LF	For Screws	
	ACBM-CC06-D17X6-W16-L150-Z02	6	17	16	30	150	-	120,00 €
	ACBM-CC06-D18X7-W16-L100-Z02-H	7	18	16	32	100	M10	97,00 €
	ACBM-CC06-D18X7-W16-L160-Z02-H	7	18	16	32	160	M10	128,00 €
	ACBM-CC06-D20X9-W20-L100-Z02-H	9	20	20	40	100	M12	102,00 €
	ACBM-CC06-D20X9-W20-L160-Z02-H	9	20	20	38	160	M12	137,00 €
	ACBM-CC09-D26X8.5-W25-L130-Z02-H	8.5	26	25	50	130	M16	108,00 €
	ACBM-CC09-D26X8.5-W25-L200-Z02	8.5	26	25	50	200	M16	173,00 €
	ACBM-CC09-D26X8.5-W25-L200-Z02-H	8.5	26	25	50	200	M16	173,00 €
	ACBM-CC09-D30X12.5-W32-L130-Z02-H	12.5	30	32	65	130	-	120,00 €
	ACBM-CC09-D33X15.5-W32-L130-Z02-H	15.5	33	32	65	130	M20	120,00 €
	ACBM-CC09-D33X15.5-W32-L200-Z02	15.5	33	32	65	200	M20	196,00 €
	ACBM-CC09-D33X15.5-W32-L200-Z02-H	15.5	33	32	65	200	M20	196,00 €
	ACBM-SP06-D15X4-W16-L160-Z02-H	4	15	16	80	160	M8	128,00 €

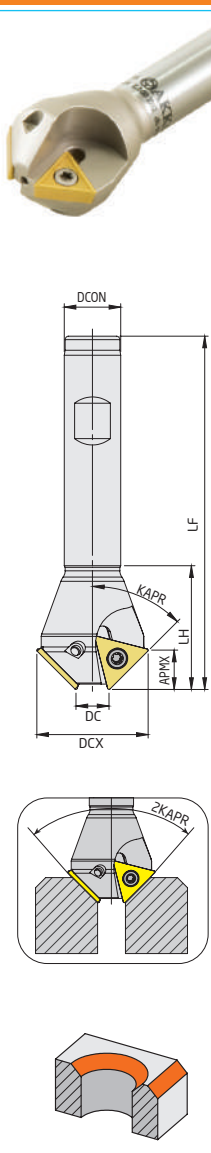
CHAMFERING TOOLS / FASENFRÄSER

	CODE / TYP	TOOL DIMENSIONS (mm) MAß								CUTTING INSERT WENDE PLATTE	PRICE / PREIS
		KAPR	DC	DCX	DCON	LF	LH	ZEFP	APMX		
	ACM10-TC16-D17X22-W16-L90-Z01	10°	17	22	16	90	30	1	15.2		66,00 €
	ACM15-TC16-D17X24-W16-L90-Z01	15°	17	24	16	90	30	1	14.9		66,00 €
	ACM15-TC16-D22X29-W16-L100-Z01	15°	22	29	16	100	30	1	14.9		66,00 €
	ACM15-TC16-D30X37-W20-L100-Z02	15°	30	37	20	100	35	2	14.9		97,00 €
	ACM15-TC16-D35X42-W20-L100-Z03	15°	35	42	20	100	38	3	14.9		108,00 €
	ACM15-TC16-D52X59-W25-L110-Z03	15°	52	59	25	110	40	3	14.9		108,00 €
	ACM17.5-TC16-D17X25-W16-L90-Z01	17.5°	17	25	16	90	30	1	14.7		66,00 €
	ACM18.5-TC16-D21.3X30-W20-L100-Z02	18.5°	21.3	30	20	100	30	2	13.5		66,00 €
	ACM20-TC16-D12X22-W16-L100-Z01	20°	12	22	16	100	30	1	14.4		66,00 €
	ACM20-TC16-D17X27-W16-L100-Z01	20°	17	27	16	100	30	1	14.4		66,00 €
	ACM20-TC16-D23X33-W20-L100-Z02	20°	23	33	20	100	30	2	14.4		97,00 €
	ACM20-TC16-D28X38-W20-L100-Z02	20°	28	38	20	100	35	2	14.4	T.C.T 16T304	97,00 €
	ACM20-TC16-D35X45-W20-L100-Z03	20°	35	45	20	100	40	3	14.4	FOR ISO	108,00 €
	ACM20-TC16-D39X49-W20-L100-Z03	20°	39	49	20	100	40	3	14.4	INSERT.	108,00 €
	ACM20-TC16-D45X55-W25-L110-Z03	20°	45	55	25	110	40	3	14.4		108,00 €
	ACM20-TC16-D51X61-W25-L110-Z03	20°	51	61	25	110	40	3	14.4		108,00 €
	ACM22.5-TC16-D17X28-W16-L100-Z01	22.5°	17	28	16	100	30	1	14.2		66,00 €
	ACM25-TC16-D17X29-W16-L100-Z01	25°	17	29	16	100	30	1	13.9		66,00 €
	ACM30-TC16-D6X20-W16-L100-Z01	30°	6	20	16	100	30	1	13.3		66,00 €
	ACM30-TC16-D15X30-W16-L100-Z01	30°	15	30	16	100	30	1	13.3		66,00 €
	ACM30-TC16-D17.5X32.5-W20-L100-Z02	30°	17.5	32.5	20	100	30	2	13.3		66,00 €
	ACM30-TC16-D20X35-W16-L100-Z02	30°	20	35	16	100	35	2	13.3		66,00 €
	ACM30-TC16-D30X45-W20-L100-Z02	30°	30	45	20	100	40	2	13.3		66,00 €
	ACM30-TC16-D35X50-W20-L100-Z03	30°	35	50	20	100	40	3	13.3		108,00 €
	ACM30-TC16-D45X60-W25-L110-Z03	30°	45	60	25	110	40	3	13.3		108,00 €
	ACM40-TC16-D18X37-W20-L100-Z02	40°	18	37	20	100	40	2	11.7		66,00 €
	ACM45-TC09-D7X18-W16-L100-Z02	45°	7	18	16	100	25	2	5.9	T.C.T 090204	66,00 €
	ACM45-TC11-D11X24-W16-L100-Z02	45°	11	24	16	100	25	2	6.9	T.C.T 110204	66,00 €
	ACM45-TC16-D5X26-W16-L100-Z01	45°	5	26	16	100	30	1	10.8		66,00 €
	ACM45-TC16-D10X31-W16-L100-Z02	45°	10	31	16	100	35	2	10.8		66,00 €
	ACM45-TC16-D10X31-W20-L100-Z02	45°	10	31	20	100	35	2	10.8		66,00 €
	ACM45-TC16-D18X39-W16-L100-Z02	45°	18	39	16	100	40	2	10.8		66,00 €
	ACM45-TC16-D18X39-W20-L100-Z02	45°	18	39	20	100	40	2	10.8	T.C.T 16T304	66,00 €
ACM45-TC16-D20X41-W20-L100-Z02	45°	20	41	20	100	40	2	10.8	FOR ISO	66,00 €	
ACM45-TC16-D30X51-W20-L100-Z02	45°	30	51	20	100	40	2	10.8	INSERT.	66,00 €	
ACM50-TC16-D16X39-W20-L100-Z03	50°	16	39	20	100	40	3	9.8		66,00 €	
ACM55-TC16-D16X40-W20-L100-Z03	55°	16	40	20	100	40	3	8.7		108,00 €	
ACM62-TC16-D14X40-W20-L100-Z03	62°	14	40	20	100	40	3	7.1		108,00 €	
ACM72-TC16-D14X42-W20-L100-Z03	72°	14	42	20	100	40	3	4.6		108,00 €	
	ACM45-SP1104-D12x26-W20-L150-Z01	45°	12	26	20	150	30	1	-	SPGT	81,00 €
	ACM45-SP1104-D25x39-W25-L150-Z02	45°	25	39	25	150	35	2	-	110408	102,00 €
	ACM45-SP1104-D32x46-W32-L150-Z03	45°	32	46	32	150	40	3	-	FOR ZCC INSERT.	123,00 €

Cutting Calculation : P 166 / Schnittdatenberechnung : S 166



Ordering Example/Beispiel Bestellformular: 1pcs. ACM10-TC16-D17X22-W16-L90-Z01



END MILLS / WP - SCHAFTFRÄSER

	CODE / TYP	TOOL DIMENSIONS (mm) <small>MAS</small>						CUTTING INSERT WENDE PLATTE	PRICE / PREIS
		DC	ZFP	DCON	LF	LH	APMX		
	AEM90-AD07-D10-C08-L90-Z02-H	10	2	8	90	16	6	ADMX 0702..	157,00 €
	AEM90-AD07-D10-C10-L80-Z02-H	10	2	10	80	16	6	FOR PRMT	127,00 €
	AEM90-AD07-D12-C10-L80-Z03-H	12	3	10	80	18	6	INSERT.	159,00 €
	AEM90-AD07-D12-C12-L90-Z03-H	12	3	12	90	18	6		156,00 €
	AEM90-AD07-D16-C16-L110-Z04-H	16	4	16	110	19	6		200,00 €
	AEM90-AD07-D20-C20-L125-Z05-H	20	5	20	125	20	6		251,00 €
	AEM90-AD07-D25-C25-L140-Z06-H	25	6	25	140	24	6		304,00 €
	AEM90-AD11-D16-C16-L135-Z02-H	16	2	16	135	24	9		112,00 €
	AEM90-AD11-D18-C16-L135-Z02-H	18	2	16	135	15	9		112,00 €
	AEM90-AD11-D18-C16-L160-Z02-H	18	2	16	160	15	9		135,00 €
	AEM90-AD11-D20-C20-L150-Z02-H	20	2	20	150	50	9		127,00 €
	AEM90-AD11-D20-C20-L150-Z03-H	20	3	20	150	50	9		152,00 €
	AEM90-AD11-D22-C20-L150-Z03-H	22	3	20	150	15	9	ADMX 11T30..	152,00 €
	AEM90-AD11-D22-C20-L200-Z03-H	22	3	20	200	15	9	FOR PRMT	227,00 €
	AEM90-AD11-D25-C25-L170-Z03-H	25	3	25	170	50	9	INSERT.	205,00 €
	AEM90-AD11-D25-C25-L170-Z04-H	25	4	25	170	50	9		228,00 €
	AEM90-AD11-D28-C25-L165-Z04-H	28	4	25	165	17	9		194,00 €
	AEM90-AD11-D28-C25-L200-Z04-H	28	4	25	200	17	9		263,00 €
	AEM90-AD11-D30-C25-L165-Z04-H	30	4	25	165	19	9		194,00 €
AEM90-AD11-D30-C25-L200-Z04-H	30	4	25	200	19	9		263,00 €	
AEM90-AD11-D32-C32-L195-Z05-H	32	5	32	195	50	9		281,00 €	
	AEM90-AD1505-D25-W25-L150-Z02	25	2	25	150	50	15	AD.. 1505..	125,00 €
	AEM90-AD1505-D30-W25-L150-Z03	30	3	25	150	50	15	FOR ISCR	142,00 €
	AEM90-AD1505-D32-W32-L150-Z03	32	3	32	150	50	15	INSERT.	142,00 €
	AEM90-AD0803-D16-W16-L150-Z02	16	2	16	150	30	8		102,00 €
	AEM90-AD0803-D17-W16-L150-Z02	17	2	16	150	30	8	ADMT 0803..	102,00 €
	AEM90-AD0803-D17-W16-L200-Z02	17	2	16	200	30	8	FOR WLTR	144,00 €
	AEM90-AD0803-D20-W20-L150-Z03	20	3	20	150	30	8	INSERT.	123,00 €
	AEM90-AD0803-D21-W20-L200-Z03	21	3	20	200	30	8		194,00 €
	AEM90-AD10T3-D16-W16-L100-Z02-H	16	2	16	100	30	10		102,00 €
	AEM90-AD10T3-D16-W16-L150-Z02	16	2	16	150	40	10		102,00 €
	AEM90-AD10T3-D16-C16-L200-Z02	16	2	16	200	50	10		144,00 €
	AEM90-AD10T3-D17-W16-L150-Z02	17	2	16	150	30	10		102,00 €
	AEM90-AD10T3-D17-W16-L200-Z02	17	2	16	200	30	10		144,00 €
	AEM90-AD10T3-D20-W20-L70-Z03	20	3	20	70	30	10	ADMT 10T3..	111,00 €
	AEM90-AD10T3-D20-W20-L100-Z03-H	20	3	20	100	30	10	FOR WLTR	123,00 €
	AEM90-AD10T3-D20-W20-L150-Z03	20	3	20	150	30	10	INSERT.	123,00 €
	AEM90-AD10T3-D20-C20-L150-Z03	20	3	20	150	40	10		123,00 €
	AEM90-AD10T3-D20-C20-L200-Z03	20	3	20	200	40	10		199,00 €
	AEM90-AD10T3-D25-W25-L100-Z03-H	25	3	25	100	30	10		127,00 €
	AEM90-AD10T3-D25-W25-L100-Z04-H	25	4	25	100	30	10		152,00 €
	AEM90-AD10T3-D25-W25-L150-Z03	25	3	25	150	50	10		127,00 €
	AEM90-AD1204-D20-W20-L150-Z02	20	2	20	150	50	12		111,00 €
	AEM90-AD1204-D21-C20-L150-Z02	21	2	20	150	30	12	ADMT 1204..	111,00 €
	AEM90-AD1204-D22-C20-L150-Z02	22	2	20	150	30	12	FOR WLTR	111,00 €
	AEM90-AD1204-D25-W25-L150-Z03	25	3	25	150	50	12	INSERT.	129,00 €
	AEM90-AD1204-D26-W25-L180-Z03	26	3	25	180	35	12		181,00 €
	AEM90-AD1204-D32-W32-L150-Z04	32	4	32	150	50	12		146,00 €
	AEM90-AD1606-D25-W25-L150-Z02	25	2	25	150	50	15	ADMT 1606..	129,00 €
	AEM90-AD1606-D32-W32-L150-Z03	32	3	32	150	50	15	FOR WLTR	146,00 €
								INSERT.	

END MILLS / WP - SCHAFTFRÄSER

	CODE / TYP	TOOL DIMENSIONS (mm) <i>MAB</i>						CUTTING INSERT WENDE PLATTE	PRICE / PREIS
		DC	ZEFP	DCON	LF	LH	APMX		
 90°	AEM90-AD1003-D16-C16-L150-Z02	16	2	16	150	30	8		102,00 €
	AEM90-AD1003-D17-C16-L150-Z02	17	2	16	150	25	8		102,00 €
	AEM90-AD1003-D20-C20-L200-Z03	20	3	20	200	50	8	ADMT 1003..	185,00 €
	AEM90-AD1003-D21-C20-L150-Z03	21	3	20	150	25	8	FOR DJT	114,00 €
	AEM90-AD1003-D21-C20-L200-Z03	21	3	20	200	25	8	INSERT.	185,00 €
	AEM90-AD1003-D25-C25-L200-Z03	25	3	25	200	50	8		197,00 €
	AEM90-AD1003-D26-C25-L150-Z03	26	3	25	150	30	8		114,00 €
	AEM90-AD1003-D26-C25-L200-Z03	26	3	25	200	30	8		182,00 €
	AEM90-AD1505D-D25-W25-L150-Z02	25	2	25	150	50	14.3	ADKT 150508	125,00 €
AEM90-AD1505D-D32-W32-L150-Z03	32	3	32	150	50	14.3	FOR DJT INSERT.	142,00 €	
 90°	AEM90-AN11-D22-W20-L150-Z02	22	2	20	150	30	11		134,00 €
	AEM90-AN11-D25-W25-L150-Z02	25	2	25	150	40	11		117,00 €
	AEM90-AN11-D25-C25-L200-Z02	25	2	25	200	40	11		175,00 €
	AEM90-AN11-D26-W25-L150-Z02	26	2	25	150	40	11	ANGX 110508	141,00 €
	AEM90-AN11-D28-W25-L150-Z02	28	2	25	150	25	11	FOR ZCC	120,00 €
	AEM90-AN11-D32-W32-L150-Z03	32	3	32	150	50	11	INSERT.	137,00 €
	AEM90-AN11-D32-C32-L200-Z03	32	3	32	200	50	11		204,00 €
	AEM90-AN11-D40-W32-L150-Z04	40	4	32	150	40	11		156,00 €
 90°	AEM90-AN1207-D25-W25-L150-Z02	25	2	25	150	40	10	ANKX 1207..	134,00 €
	AEM90-AN1207-D32-W32-L150-Z03	32	3	32	150	50	10	FOR XTC-GSC	137,00 €
	AEM90-AN1207-D40-W32-L150-Z04	40	4	32	150	40	10	INSERT.	156,00 €
 90°	AEM90-AN1607-D32-C25-L150-Z02	32	2	25	150	40	15	AN.X 1607..	144,00 €
	AEM90-AN1607-D40-C32-L150-Z03	40	3	32	150	45	15	FOR TGTC INSERT.	182,00 €

Cutting Calculation : P 166 / Schnittdatenberechnung : S 166

Ordering Example/Beispiel Bestellformular: 1pcs. AEM90-AD1003-D16-C16-L150-Z02



END MILLS / WP - SCHAFTFRÄSER

	CODE / TYP	TOOL DIMENSIONS (mm) <small>MAB</small>						CUTTING INSERT WENDE PLATTE	PRICE / PREIS
		DC	ZEFP	DCON	LF	LH	APMX		
	AEM90-AP06-D10-C10-L120-Z02	10	2	10	120	20	5.6	APMT 0602..	140,00 €
	AEM90-AP06-D12-C12-L120-Z02	12	2	12	120	20	5.6	FOR KRLY INSERT.	140,00 €
	AEM90-AP0903-D12-C16-L080-Z01-H	12	1	16	80	30	9		96,00 €
	AEM90-AP0903-D16-C16-L090-Z02	16	2	16	90	30	9		114,00 €
	AEM90-AP0903-D16-C16-L150-Z02	16	2	16	150	30	9		114,00 €
	AEM90-AP0903-D17-C16-L150-Z02	17	2	16	150	30	9		114,00 €
	AEM90-AP0903-D18-C16-L090-Z02-H	18	2	16	90	30	9	APMT 0903..	114,00 €
	AEM90-AP0903-D20-C20-L110-Z03	20	3	20	110	30	9	FOR KRLY INSERT.	138,00 €
	AEM90-AP0903-D20-C20-L150-Z02	20	2	20	150	30	9		126,00 €
	AEM90-AP0903-D20-C20-L200-Z02	20	2	20	200	100	9		168,00 €
	AEM90-AP0903-D21-C20-L150-Z02	21	2	20	150	30	9		126,00 €
	AEM90-AP0903-D25-C25-L120-Z03	25	3	25	120	30	9		138,00 €
	AEM90-AP0903-D25-C25-L150-Z03	25	3	25	150	30	9		138,00 €
	AEM90-AP0903-D25-C25-L200-Z02	25	2	25	200	100	9		168,00 €
	AEM90-AP09-D16-C16-L100-Z02-H	16	2	16	100	30	8.8		93,00 €
	AEM90-AP09-D16-C15-L150-Z02	16	2	15	150	25	8.8		114,00 €
	AEM90-AP09-D16-W16-L150-Z02-H	16	2	16	150	25	8.8		105,00 €
	AEM90-AP09-D16-C16-L200-Z02-H	16	2	16	200	100	8.8		186,00 €
	AEM90-AP09-D17-C16-L150-Z02	17	2	16	150	25	8.8	APKT 09T3..	114,00 €
	AEM90-AP09-D17-C16-L180-Z02-H	17	2	16	180	25	8.8	FOR TGTC INSERT.	175,00 €
	AEM90-AP09-D20-C20-L150-Z03-H	20	3	20	150	50	8.8		120,00 €
	AEM90-AP09-D20-C20-L200-Z03-H	20	3	20	200	100	8.8		200,00 €
	AEM90-AP09-D20-C20-L250-Z02-H	20	2	20	250	150	8.8		299,00 €
	AEM90-AP09-D21-C20-L150-Z03	21	3	20	150	25	8.8		133,00 €
	AEM90-AP09-D21-C20-L180-Z02-H	21	2	20	180	25	8.8		172,00 €
	AEM90-AP09-D26-C25-L150-Z04	26	4	25	150	30	8.8		152,00 €
	AEM90-AP10-D10-C10-L100-Z01	10	1	10	100	20	10		79,00 €
	AEM90-AP10-D12-C16-L100-Z01-H	12	1	16	100	30	10		79,00 €
	AEM90-AP10-D12-W16-L100-Z01-H	12	1	16	100	30	10		79,00 €
	AEM90-AP10-D12-W16-L150-Z01	12	1	16	150	38	10		79,00 €
	AEM90-AP10-D14-W16-L100-Z01-H	14	1	16	100	30	10		79,00 €
	AEM90-AP10-D14-W16-L150-Z01	14	1	16	150	38	10		79,00 €
	AEM90-AP10-D16-C16-L100-Z02-H	16	2	16	100	30	10	AP.. 1003..	93,00 €
	AEM90-AP10-D16-W16-L85-Z02-H	16	2	16	85	30	10	FOR ISO INSERT.	93,00 €
	AEM90-AP10-D16-W16-L100-Z02-H	16	2	16	100	30	10		93,00 €
	AEM90-AP10-D16-W16-L150-Z02-H	16	2	16	150	50	10		105,00 €
	AEM90-AP10-D16-C16-L120-Z02-H	16	2	16	120	30	10		93,00 €
	AEM90-AP10-D16-C16-L150-Z02	16	2	16	150	50	10		105,00 €
	AEM90-AP10-D16-C16-L150-Z02-H	16	2	16	150	50	10		105,00 €
	AEM90-AP10-D16-W16-L150-Z02	16	2	16	150	50	10		93,00 €
	AEM90-AP10-D16-C16-L200-Z02	16	2	16	200	100	10		131,00 €
	AEM90-AP10-D16-C16-L200-Z02-H	16	2	16	200	100	10		165,00 €
	AEM90-AP10-D16-W16-L200-Z02	16	2	16	200	100	10		131,00 €
	AEM90-AP10-D16-C16-L250-Z02	16	2	16	250	50	10		222,00 €
	AEM90-AP10-D17-C16-L150-Z02	17	2	16	250	150	10		93,00 €
AEM90-AP10-D18-W16-L100-Z02-H	18	2	16	100	30	10		96,00 €	
AEM90-AP10-D18-W16-L150-Z02	18	2	16	150	30	10		96,00 €	
AEM90-AP10-D20-C19-L180-Z02	20	2	19	180	30	10		148,00 €	
AEM90-AP10-D20-C20-L100-Z03-H	20	3	20	100	30	10		107,00 €	
AEM90-AP10-D20-W20-L90-Z03-H	20	3	20	90	30	10		107,00 €	
AEM90-AP10-D20-W20-L100-Z03-H	20	3	20	100	30	10		107,00 €	
AEM90-AP10-D20-C20-L120-Z03-H	20	3	20	120	30	10		107,00 €	
AEM90-AP10-D20-C20-L150-Z03	20	3	20	150	50	10		120,00 €	

90°

END MILLS / WP - SCHAFTFRÄSER

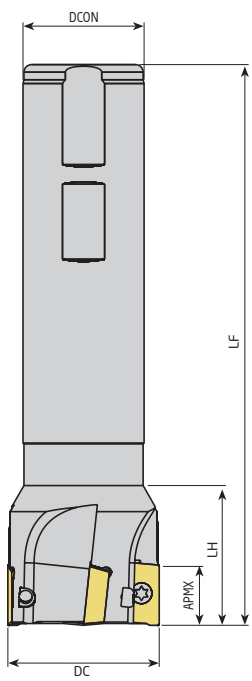
	CODE / TYP	TOOL DIMENSIONS (mm) <small>MAß</small>						CUTTING INSERT WENDE PLATTE	PRICE / PREIS
		DC	ZEFP	DCON	LF	LH	APMX		
  90°	AEM90-AP10-D20-C20-L150-Z03-H	20	3	20	150	50	10		120,00 €
	AEM90-AP10-D20-W20-L150-Z03	20	3	20	150	50	10		107,00 €
	AEM90-AP10-D20-C20-L200-Z02	20	2	20	200	100	10		165,00 €
	AEM90-AP10-D20-C20-L200-Z03-H	20	3	20	200	100	10		200,00 €
	AEM90-AP10-D20-C20-L250-Z02	20	2	20	250	150	10		234,00 €
	AEM90-AP10-D20-C20-L250-Z02-H	20	2	20	250	150	10		299,00 €
	<small>NEW</small> AEM90-AP10-D20.5-C20-L90-Z03	20.5	3	20	90	30	10		107,00 €
	<small>NEW</small> AEM90-AP10-D21-C20-L150-Z03	21	3	20	200	35	10		107,00 €
	AEM90-AP10-D21-W20-L150-Z03	21	3	20	150	30	10		107,00 €
	AEM90-AP10-D21-C20-L200-Z03-H	21	3	20	200	35	10		200,00 €
	AEM90-AP10-D21-C20-L200-Z03	21	3	20	200	30	10		182,00 €
	AEM90-AP10-D22-W20-L100-Z03-H	22	3	20	100	30	10		107,00 €
	AEM90-AP10-D22-W20-L150-Z03	22	3	20	150	30	10		107,00 €
	<small>NEW</small> AEM90-AP10-D22.5-W20-L150-Z03	22.5	3	20	150	30	10		107,00 €
	AEM90-AP10-D23-W20-L150-Z03	23	3	20	150	30	10		107,00 €
	AEM90-AP10-D24-W20-L150-Z03	24	3	20	150	30	10		107,00 €
	AEM90-AP10-D25-W25-L100-Z04-H	25	4	25	100	30	10	AP.. 1003..	138,00 €
	<small>NEW</small> AEM90-AP10-D25-W25-L95-Z04-H	25	4	25	95	30	10	FOR ISO	138,00 €
	AEM90-AP10-D25-W25-L150-Z04-H	25	4	25	150	50	10	INSERT.	165,00 €
	AEM90-AP10-D25-C25-L100-Z03-H	25	3	25	100	30	10		114,00 €
	AEM90-AP10-D25-W25-L100-Z03-H	25	3	25	100	30	10		114,00 €
	AEM90-AP10-D25-C25-L120-Z03-H	25	3	25	120	30	10		107,00 €
	AEM90-AP10-D25-C25-L150-Z03	25	3	25	150	50	10		107,00 €
	AEM90-AP10-D25-W25-L150-Z03	25	3	25	150	50	10		114,00 €
	AEM90-AP10-D25-C25-L200-Z02	25	2	25	200	100	10		170,00 €
	AEM90-AP10-D25-C25-L200-Z03	25	3	25	200	100	10		182,00 €
	AEM90-AP10-D25-C25-L250-Z02	25	2	25	250	100	10		214,00 €
	AEM90-AP10-D26-C25-L200-Z04	26	4	25	200	35	10		205,00 €
	AEM90-AP10-D30-C25-L100-Z04-H	30	4	25	100	30	10		126,00 €
	AEM90-AP10-D30-C25-L120-Z04-H	30	4	25	120	30	10		126,00 €
	AEM90-AP10-D30-C25-L150-Z04	30	4	25	150	30	10		126,00 €
	AEM90-AP10-D32-C25-L100-Z04-H	32	4	25	100	35	10		126,00 €
	AEM90-AP10-D32-C25-L120-Z04-H	32	4	25	120	35	10		126,00 €
	AEM90-AP10-D32-C25-L150-Z04	32	4	25	150	35	10		126,00 €
	AEM90-AP10-D32-W25-L150-Z04	32	4	25	150	35	10		126,00 €
	<small>NEW</small> AEM90-AP10-D32-C32-L170-Z04	32	4	32	170	50	10		142,00 €
	<small>NEW</small> AEM90-AP10-D32-W25-L105-Z05-H	32	5	25	105	35	10		174,00 €
	AEM90-AP10-D32-C32-L130-Z05	32	5	32	130	30	10		138,00 €
	AEM90-AP10-D32-W32-L150-Z04	32	4	32	150	50	10		126,00 €
	AEM90-AP10-D40-W32-L150-Z05	40	5	32	150	40	10		144,00 €
	AEM90-AP10D-D16-W16-L150-Z02	16	2	16	150	50	10	AP.. 1003..	93,00 €
	AEM90-AP10D-D20-W20-L150-Z03	20	3	20	150	50	10	FOR DJT	107,00 €
	AEM90-AP10D-D25-W20-L150-Z03	25	3	20	150	30	10	INSERT.	114,00 €
	AEM90-AP100-D16-C15-L150-Z02	16	2	15	150	30	10	AP.. 1003..	99,00 €
	AEM90-AP100-D21-C20-L150-Z03	21	3	20	150	30	10	FOR B.OKE	117,00 €
AEM90-AP100-D26-C25-L150-Z04	26	4	25	150	35	10	INSERT.	133,00 €	
AEM90-AP100-D33-C32-L200-Z05	33	5	32	200	50	10		205,00 €	
AEM90-AP10S-D16-W16-L150-Z02	16	2	16	150	26	10	AP.. 1003..	99,00 €	
AEM90-AP10S-D20-W20-L150-Z02	20	2	20	150	26	10	FOR SMTM	105,00 €	
AEM90-AP10S-D25-W25-L150-Z03	25	3	25	150	26	10	INSERT.	117,00 €	
AEM90-AP11-D16-C16-L150-Z02	16	2	16	150	50	11		93,00 €	
AEM90-AP11-D16-C16-L150-Z02-H	16	2	16	150	50	11		105,00 €	
AEM90-AP11-D16-W16-L150-Z02	16	2	16	150	50	11	AP.. 11T3..	93,00 €	
AEM90-AP11-D16-W16-L150-Z02-H	16	2	16	150	50	11	FOR ZCC	105,00 €	
AEM90-AP11-D16-C16-L200-Z02	16	2	16	200	100	11	INSERT.	131,00 €	
AEM90-AP11-D17-C16-L150-Z02	17	2	16	150	30	11		105,00 €	
AEM90-AP11-D17-C16-L200-Z02	17	2	16	200	30	11		144,00 €	
AEM90-AP11-D20-C20-L150-Z03	20	3	20	150	50	11		107,00 €	

END MILLS / WP - SCHAFTFRÄSER

	CODE / TYP	TOOL DIMENSIONS (mm) <small>MAß</small>						CUTTING INSERT WENDE PLATTE	PRICE / PREIS
		DC	ZEFP	DCON	LF	LH	APMX		
	AEM90-AP11-D20-W20-L150-Z03	20	3	20	150	50	11		107,00 €
	AEM90-AP11-D20-W20-L150-Z03-H	20	3	20	150	50	11		120,00 €
	AEM90-AP11-D20-C20-L200-Z03	20	3	20	200	100	11		175,00 €
	AEM90-AP11-D21-C20-L150-Z03	21	3	20	150	30	11		107,00 €
	AEM90-AP11-D21-W20-L150-Z03	21	3	20	150	30	11		107,00 €
	AEM90-AP11-D21-W20-L150-Z03-H	21	3	20	150	30	11		120,00 €
	AEM90-AP11-D21-C20-L200-Z03	21	3	20	200	30	11	AP.. 11T3..	188,00 €
	AEM90-AP11-D25-C25-L150-Z03	25	3	25	150	50	11	FOR ZCC	114,00 €
	AEM90-AP11-D25-W25-L150-Z03	25	3	25	150	50	11	INSERT.	114,00 €
	AEM90-AP11-D25-W25-L150-Z03-H	25	3	25	150	50	11		126,00 €
	AEM90-AP11-D26-C25-L150-Z03	26	3	25	150	35	11		126,00 €
	AEM90-AP11-D26-C24-L150-Z03	26	3	24	150	47	11		126,00 €
	AEM90-AP11-D32-W25-L150-Z04	32	4	25	150	35	11		126,00 €
	AEM90-AP11-D32-W32-L150-Z03-H	32	3	32	150	50	11		126,00 €
	AEM90-AP11-D32-W32-L150-Z04	32	4	32	150	50	11		126,00 €
	AEM90-AP1135A-D14-C16-L150-Z01	14	1	16	150	40	9.5		88,00 €
	AEM90-AP1135A-D16-C16-L150-Z02	16	2	16	150	40	9.5		99,00 €
	AEM90-AP1135A-D16-C16-L200-Z02	16	2	16	200	100	9.5		152,00 €
	AEM90-AP1135A-D16-C16-L250-Z02	16	2	16	250	150	9.5		224,00 €
	AEM90-AP1135A-D17-C16-L180-Z02	17	2	16	180	30	9.5	APMT 1135..	138,00 €
	AEM90-AP1135A-D20-C20-L150-Z03	20	3	20	150	50	9.5	FOR ACHTK	117,00 €
	AEM90-AP1135A-D20-C20-L200-Z02	20	2	20	200	100	9.5	INSERT.	152,00 €
	AEM90-AP1135A-D21-C20-L180-Z02	21	2	20	180	30	9.5		138,00 €
	AEM90-AP1135A-D25-C25-L200-Z03	25	3	25	200	100	9.5		195,00 €
	AEM90-AP1135A-D26-C25-L250-Z02	26	2	25	250	35	9.5		199,00 €
	AEM90-AP1135A-D33-C32-L250-Z02	33	2	32	250	35	9.5		199,00 €
	AEM90-AP110-D16-C15-L150-Z02	16	2	15	150	30	11	APMT 1135..	99,00 €
	AEM90-AP110-D21-C20-L150-Z03	21	3	20	150	30	11	FOR B.OKE	117,00 €
	AEM90-AP110-D26-C25-L150-Z04	26	4	25	150	35	11	INSERT.	133,00 €
	AEM90-AP110-D33-C32-L200-Z05	33	5	32	200	50	11		205,00 €
AEM90-APK11G-D16-W16-L150-Z02	16	2	16	150	26	11	APKT 1135..	99,00 €	
AEM90-APK11G-D20-W20-L150-Z03	20	3	20	150	26	11	FOR XTC-GSC	117,00 €	
AEM90-APK11G-D25-W25-L150-Z03	25	3	25	150	26	11	INSERT.	124,00 €	
AEM90-AP1135-D16-W16-L110-Z02-H	16	2	16	110	30	9.5		99,00 €	
AEM90-AP1135-D16-W16-L150-Z02	16	2	16	150	50	9.5		99,00 €	
AEM90-AP1135-D20-W20-L125-Z03-H	20	3	20	125	30	9.5	AP.. 1135..	117,00 €	
AEM90-AP1135-D20-W20-L150-Z03	20	3	20	150	50	9.5	FOR XTC-GSC	117,00 €	
AEM90-AP1135-D25-W25-L125-Z04-H	25	4	25	125	30	9.5	INSERT.	139,00 €	
AEM90-AP1135-D25-W25-L200-Z04-H	25	4	25	200	100	9.5		208,00 €	
AEM90-AP1135-D32-W32-L125-Z05-H	32	5	32	125	30	9.5		143,00 €	
AEM90-AP1135-D32-W32-L200-Z04-H	32	4	32	200	100	9.5		226,00 €	
AEM90-AP1135Y-D16-C16-L120-Z02-H	16	2	16	120	30	9.5		162,00 €	
AEM90-AP1135Y-D16-W16-L150-Z02	16	2	16	150	50	9.5		99,00 €	
AEM90-AP1135Y-D17-C16-L150-Z02	17	2	20	150	30	9.5		99,00 €	
AEM90-AP1135Y-D20-C20-L120-Z02	20	2	20	120	30	9.5	APMT 1135..	107,00 €	
AEM90-AP1135Y-D20-W20-L150-Z03	20	3	20	150	50	9.5	FOR YG	117,00 €	
AEM90-AP1135Y-D21-C20-L150-Z03	21	3	25	150	30	9.5	INSERT.	117,00 €	
AEM90-AP1135Y-D25-W25-L150-Z03	25	3	25	150	35	9.5		124,00 €	
AEM90-AP1135Y-D25-C25-L150-Z04-H	25	4	25	150	30	9.5		256,00 €	
AEM90-AP1135Y-D26-C25-L150-Z03	26	3	25	150	35	9.5		124,00 €	
AEM90-AP1135Y-D32-W25-L110-Z04	32	4	25	110	35	9.5		175,00 €	

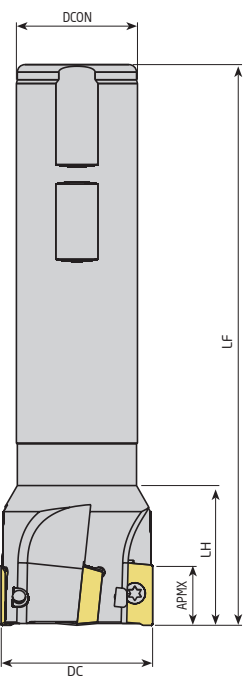

90°

END MILLS / WP - SCHAFTFRÄSER

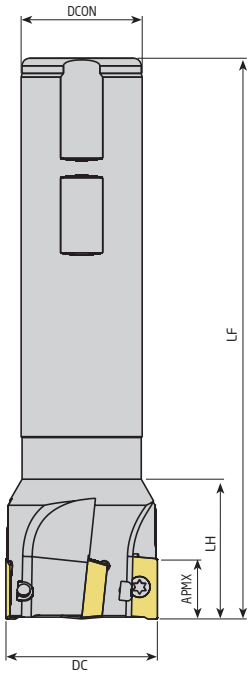
	CODE / TYP	TOOL DIMENSIONS (mm) <small>MAG</small>						CUTTING INSERT WENDE PLATTE	PRICE / PREIS
		DC	ZEFP	DCON	LF	LH	APMX		
  90°	AEM90-AP1204-D20-C20-L150-Z02	20	2	20	150	30	16		139,00 €
	AEM90-AP1204-D21-C20-L150-Z02	21	2	20	150	30	16	AP.. 1204..	139,00 €
	AEM90-AP1204-D21-C20-L200-Z02	21	2	20	200	30	16	FOR TGTC	200,00 €
	<small>NEW</small> AEM90-AP1204-D22-C20-L200-Z02	22	2	20	200	30	12	INSERT.	200,00 €
	AEM90-AP1204-D25-C25-L150-Z03	25	3	25	150	40	16		129,00 €
	<small>NEW</small> AEM90-AP1204-D25-C25-L250-Z03	25	3	25	250	40	12		152,00 €
	AEM90-AP1204-D26-C25-L250-Z02	26	2	25	250	35	16		276,00 €
	AEM90-AP1204-D32-C25-L150-Z03	32	3	25	150	35	16		157,00 €
	AEM90-AP16-D25-C20-L100-Z02	25	2	20	100	35	16		107,00 €
	AEM90-AP16-D25-W25-L100-Z02-H	25	2	25	100	35	16		107,00 €
	AEM90-AP16-D25-W25-L150-Z02	25	2	25	150	50	16		107,00 €
	AEM90-AP16-D25-C25-L250-Z02	25	2	25	250	100	16		214,00 €
	AEM90-AP16-D28-W25-L100-Z03-H	28	3	25	100	40	16		119,00 €
	AEM90-AP16-D28-W25-L150-Z03	28	3	25	150	40	16		119,00 €
	AEM90-AP16-D30-W25-L110-Z03-H	30	3	25	110	40	16		119,00 €
	AEM90-AP16-D30-W25-L150-Z02	30	2	25	150	40	16	AP.. 1604..	114,00 €
	AEM90-AP16-D30-W25-L150-Z03	30	3	25	150	40	16	FOR ISO	119,00 €
	AEM90-AP16-D32-W32-L110-Z03-H	32	3	32	110	40	16	INSERT.	119,00 €
	AEM90-AP16-D32-C32-L150-Z03	32	3	32	150	50	16		119,00 €
	AEM90-AP16-D32-W25-L150-Z03	32	3	25	150	40	16		119,00 €
	AEM90-AP16-D32-W32-L150-Z03	32	3	32	150	50	16		119,00 €
	AEM90-AP16-D32-W32-L150-Z03-H	32	3	32	150	50	16		143,00 €
	AEM90-AP16-D32-C25-L200-Z03-H	32	3	25	200	40	16		192,00 €
	AEM90-AP16-D32-C32-L250-Z02	32	3	32	250	100	16		214,00 €
	AEM90-AP16-D32-C32-L250-Z03	32	3	32	250	100	16		237,00 €
	AEM90-AP16-D35-W32-L150-Z03	35	3	32	150	40	16		125,00 €
	AEM90-AP16-D36-W32-L110-Z03-H	36	3	32	110	40	16		125,00 €
	AEM90-AP16-D36-W32-L150-Z03	36	3	32	150	40	16		125,00 €
	AEM90-AP16-D40-W32-L110-Z04-H	40	4	32	110	40	16		137,00 €
	AEM90-AP16-D40-C32-L150-Z04	40	4	32	150	40	16		137,00 €
	AEM90-AP16-D40-W32-L150-Z04	40	4	32	150	40	16		137,00 €
	AEM90-AP16-D40-C32-L250-Z02	40	2	32	250	40	16		225,00 €
	AEM90-AP16-D40-C32-L250-Z04	40	4	32	250	40	16		273,00 €
	AEM90-AP16DJ-D25-W25-L150-Z02	25	2	25	150	50	16	AP.. 1604..	107,00 €
	AEM90-AP16DJ-D25-C25-L200-Z02	25	2	25	200	50	16	FOR DJT	165,00 €
	AEM90-AP16DJ-D32-W32-L150-Z03	32	3	32	150	50	16	INSERT.	119,00 €
	AEM90-AP16DJ-D32-C32-L180-Z03	32	3	32	180	50	16		205,00 €
	AEM90-AP16DJ-D32-C32-L200-Z03	32	3	32	200	40	16		179,00 €
	AEM90-AP16D-D25-W25-L150-Z02	25	2	25	150	50	16	AP.. 1604..	107,00 €
	AEM90-AP16DJ-D25-C25-L200-Z02	25	2	25	200	50	16	FOR DJT	165,00 €
AEM90-AP16DJ-D32-W32-L150-Z03	32	3	32	150	50	16	INSERT.	119,00 €	
AEM90-AP16DJ-D32-C32-L180-Z03	32	3	32	180	50	16		205,00 €	
AEM90-AP16DJ-D32-C32-L200-Z03	32	3	32	200	50	16		192,00 €	
AEM90-AP16L-D25-C25-L120-Z02-H	25	2	25	120	45	16		107,00 €	
AEM90-AP16L-D25-C25-L150-Z02	25	2	25	150	55	16		107,00 €	
AEM90-AP16L-D25-C25-L200-Z02	25	2	25	200	55	16		159,00 €	
AEM90-AP16L-D25-C25-L250-Z02	25	2	25	250	100	16		214,00 €	
AEM90-AP16L-D30-W25-L120-Z03-H	30	3	25	120	40	16		119,00 €	
AEM90-AP16L-D32-C32-L120-Z03-H	32	3	32	120	45	16	AP.. 1604..	119,00 €	
AEM90-AP16L-D32-C32-L150-Z03	32	3	32	150	55	16	FOR LMNA	119,00 €	
AEM90-AP16L-D32-C32-L200-Z03	32	3	32	200	55	16	INSERT.	175,00 €	
AEM90-AP16L-D32-C32-L250-Z03	32	3	32	250	100	16		237,00 €	
AEM90-AP16L-D40-C32-L120-Z04-H	40	4	32	120	40	16		137,00 €	



END MILLS / WP - SCHAFTFRÄSER

	CODE / TYP	TOOL DIMENSIONS (mm) <small>MAß</small>						CUTTING INSERT WENDE PLATTE	PRICE / PREIS
		DC	ZEFP	DCON	LF	LH	APMX		
	AEM90-AP16L-D40-C32-L150-Z04	40	4	32	150	40	16	AP.. 1604..	137,00 €
	AEM90-AP16L-D40-C32-L200-Z04	40	4	32	200	40	16	FOR LMNA	201,00 €
	AEM90-AP16L-D40-C32-L250-Z04	40	4	32	250	40	16	INSERT.	273,00 €
	AEM90-AP16P-D25-W25-L100-Z02-H	25	2	25	100	35	16		107,00 €
	AEM90-AP16P-D25-W25-L150-Z02	25	2	25	150	50	16	AP.. 1604..	107,00 €
	AEM90-AP16P-D32-W32-L150-Z03	32	3	32	150	50	16	FOR PLBT	119,00 €
	AEM90-AP16P-D32-C32-L250-Z02	32	2	32	250	100	16	INSERT.	214,00 €
	AEM90-AP16P-D40-W32-L150-Z04	40	4	32	150	50	16		137,00 €
	AEM90-AP16Y-D25-C20-L100-Z02-H	25	2	20	100	35	16	AP.. 1604..	119,00 €
	AEM90-AP16Y-D25-C25-L120-Z02	25	2	25	120	50	16	FOR YG	141,00 €
	AEM90-AP16Y-D25-C25-L150-Z02	25	2	25	150	50	16	INSERT.	119,00 €
	AEM90-AP16Y-D25-C25-L250-Z02	25	2	25	250	100	16		214,00 €
	AEM90-AP1705-D25-C25-L120-Z02	25	2	25	120	40	16		157,00 €
	AEM90-AP1705-D26-C25-L200-Z02	26	2	25	200	40	16		232,00 €
	AEM90-AP1705-D26-C25-L250-Z02	26	2	25	250	40	16	AP.. 1705..	306,00 €
	AEM90-AP1705-D26-C25-L300-Z02	26	2	25	300	40	16	FOR TGTC-LMNA	347,00 €
	AEM90-AP1705-D28-W25-L075-Z02	28	2	25	75	20	16	INSERT.	158,00 €
AEM90-AP1705-D32-C25-L150-Z03	32	3	25	150	40	16		170,00 €	
AEM90-AP1705-D33-C32-L250-Z03	33	3	32	250	40	16		350,00 €	
AEM90-AP1705-D33-C32-L300-Z02	33	2	32	300	40	16		357,00 €	
	AEM90-A01236-D16-C16-L85-Z02-H	16	2	16	85	30	12		133,00 €
	AEM90-A01236-D16-C16-L160-Z02-H	16	2	16	160	25	10		157,00 €
	AEM90-A01236-D16-W16-L150-Z02	16	2	16	150	50	12		133,00 €
	NEW AEM90-A01236-D17-C16-L150-Z02-H	17	2	16	150	25	10		170,00 €
	NEW AEM90-A01236-D18-C16-L160-Z02-H	18	2	16	160	25	10		157,00 €
	AEM90-A01236-D20-C20-L100-Z02	20	2	20	100	30	12		144,00 €
	AEM90-A01236-D20-C20-L100-Z02-H	20	2	20	100	30	12		144,00 €
	NEW AEM90-A01236-D20-C20-L160-Z03-H	20	3	20	160	30	10		183,00 €
	NEW AEM90-A01236-D21-C20-L220-Z03-H	21	3	20	220	30	10	AO.. 1236..	268,00 €
	NEW AEM90-A01236-D22-C20-L160-Z03-H	22	3	20	160	30	10	FOR MTSBH	183,00 €
	AEM90-A01236-D25-C25-L115-Z02	25	2	25	115	50	12	INSERT.	157,00 €
	AEM90-A01236-D25-C25-L115-Z02-H	25	2	25	115	30	12		157,00 €
	AEM90-A01236-D25-W25-L150-Z03	25	3	25	150	50	12		162,00 €
	NEW AEM90-A01236-D25-C25-L160-Z04-H	25	4	25	160	50	10		207,00 €
	NEW AEM90-A01236-D26-C25-L150-Z04-H	26	4	25	150	35	10		224,00 €
	NEW AEM90-A01236-D26-C25-L160-Z04-H	26	4	25	160	35	10		207,00 €
	NEW AEM90-A01236-D32-W32-L150-Z04	32	4	32	150	50	12		185,00 €
NEW AEM90-A01236-D32-C32-L160-Z05-H	32	5	32	160	50	10		235,00 €	
	AEM90-AX0602-D10-C09-L120-Z02	10	2	9	120	15	5.7		157,00 €
	AEM90-AX0602-D10-C10-L080-Z02	10	2	10	80	20	5.7		157,00 €
	AEM90-AX0602-D10-C10-L120-Z02	10	2	10	120	20	5.7		157,00 €
	AEM90-AX0602-D12-C11-L120-Z02	12	2	11	120	15	5.7		157,00 €
	AEM90-AX0602-D12-C12-L080-Z02	12	2	12	80	20	5.7	AX.T 0602..	157,00 €
	AEM90-AX0602-D12-C12-L120-Z02	12	2	12	120	20	5.7	FOR TGTC	157,00 €
	AEM90-AX0602-D14-C12-L120-Z03	14	3	12	120	20	5.7	INSERT.	175,00 €
	AEM90-AX0602-D16-W16-L120-Z04-H	16	4	16	120	20	5.7		135,00 €
	AEM90-AX0602-D16-W16-L150-Z04-H	16	4	16	150	20	5.7		153,00 €
	AEM90-AX0602-D20-W20-L120-Z05-H	20	5	20	120	25	5.7		159,00 €
	AEM90-AX0602-D20-W20-L150-Z05-H	20	5	20	150	25	5.7		175,00 €
	AEM90-AX0903-D16-C16-L120-Z02	16	2	16	120	30	8.8		114,00 €
	AEM90-AX0903-D16-C16-L180-Z02	16	2	16	180	30	8.8		170,00 €
	AEM90-AX0903-D17-C16-L120-Z02	17	2	16	120	25	8.8		114,00 €
	AEM90-AX0903-D17-C16-L180-Z02	17	2	16	180	25	8.8		170,00 €
	AEM90-AX0903-D20-C20-L120-Z03	20	3	20	120	30	8.8	AX.T 0903..	139,00 €
	AEM90-AX0903-D20-C20-L200-Z02	20	2	20	200	30	8.8	FOR TGTC	200,00 €
	AEM90-AX0903-D21-C20-L120-Z03	21	3	20	120	25	8.8	INSERT.	139,00 €
	AEM90-AX0903-D21-C20-L200-Z02	21	2	20	200	25	8.8		200,00 €
	AEM90-AX0903-D25-C25-L150-Z03	25	3	25	150	30	8.8		139,00 €
	AEM90-AX0903-D25-C25-L250-Z02	25	2	25	250	40	8.8		276,00 €
	AEM90-AX0903-D26-C25-L150-Z03	26	3	25	150	30	8.8		139,00 €

END MILLS / WP - SCHAFTFRÄSER

	CODE / TYP	TOOL DIMENSIONS (mm) <small>MAß</small>						CUTTING INSERT <small>WENDE PLATTE</small>	PRICE / PREIS	
		DC	ZFP	DCON	LF	LH	APMX			
	AEM90-AX1235-D16-C14-L120-Z02-H	16	2	14	120	25	10		131,00 €	
	AEM90-AX1235-D16-C15-L145-Z02-H	16	2	15	145	30	10		141,00 €	
	AEM90-AX1235-D16-C16-L100-Z02-H	16	2	16	100	30	10		131,00 €	
	AEM90-AX1235-D16-C16-L140-Z02-H	16	2	16	140	30	10		131,00 €	
	AEM90-AX1235-D16-C16-L145-Z02-H	16	2	16	145	30	10		141,00 €	
	AEM90-AX1235-D16-C16-L150-Z02	16	2	16	150	30	10		131,00 €	
	AEM90-AX1235-D20-C19-L150-Z02-H	20	2	19	150	40	10		151,00 €	
	AEM90-AX1235-D20-C20-L110-Z03-H	20	3	20	110	40	10		158,00 €	
	AEM90-AX1235-D20-C20-L150-Z02	20	2	20	150	40	10	AX.T 1235..	139,00 €	
	AEM90-AX1235-D20-C20-L150-Z02-H	20	2	20	150	40	10	FOR SMTM INSERT.	151,00 €	
	AEM90-AX1235-D20-C20-L150-Z03	20	3	20	150	40	10		158,00 €	
	AEM90-AX1235-D25-C20-L120-Z04-H	25	4	20	120	30	10		185,00 €	
	AEM90-AX1235-D25-C20-L150-Z04-H	25	4	20	150	30	10		185,00 €	
	AEM90-AX1235-D25-C24-L170-Z02-H	25	2	24	170	50	10		168,00 €	
	AEM90-AX1235-D25-C25-L120-Z04-H	25	4	25	120	40	10		168,00 €	
	AEM90-AX1235-D25-C25-L150-Z03	25	3	25	150	50	10		167,00 €	
	AEM90-AX1235-D25-C25-L170-Z02-H	25	2	25	170	50	10		168,00 €	
	AEM90-AX1235-D25-W25-L100-Z04-H	25	4	25	100	30	10		185,00 €	
	AEM90-AX1235-D32-C32-L130-Z05-H	32	5	32	130	40	10		197,00 €	
	AEM90-AX1235-D32-C32-L180-Z02-H	32	2	32	180	50	10		175,00 €	
AEM90-AX1705-D25-C25-L150-Z02	25	2	25	150	50	14		153,00 €		
AEM90-AX1705-D28-W25-L115-Z02-H	28	2	25	115	35	14	AX.T 1705..	162,00 €		
AEM90-AX1705-D32-C32-L150-Z03	32	3	32	150	50	14	FOR SMTM INSERT.	181,00 €		
AEM90-AX1705-D32-C32-L180-Z02-H	32	2	32	180	50	14		199,00 €		
90°										
	AEM90-AZ11-D12-W16-L90-Z01	12	1	16	90	30	11		79,00 €	
	AEM90-AZ11-D16-C16-L200-Z02	16	2	16	200	100	11		131,00 €	
	AEM90-AZ11-D16-W15-L170-Z02	16	2	15	170	50	11		111,00 €	
	AEM90-AZ11-D16-W16-L100-Z02	16	2	16	100	35	11		93,00 €	
	AEM90-AZ11-D16-W16-L150-Z02	16	2	16	150	50	11		93,00 €	
	AEM90-AZ11-D17-C16-L150-Z02	17	2	16	150	30	11		93,00 €	
	AEM90-AZ11-D17-C16-L180-Z02	17	2	16	180	50	11		135,00 €	
	AEM90-AZ11-D17-W16-L100-Z02	17	2	16	100	30	11		105,00 €	
	AEM90-AZ11-D18-W16-L120-Z02	18	2	16	120	18	11		105,00 €	
	AEM90-AZ11-D20-C20-L200-Z03	20	3	20	200	100	11		199,00 €	
	AEM90-AZ11-D20-W19-L170-Z03	20	3	19	170	50	11	AZGT 1135..	128,00 €	
	AEM90-AZ11-D20-W20-L110-Z02	20	2	20	110	35	11	FOR ZCC INSERT.	107,00 €	
	AEM90-AZ11-D21-C20-L150-Z03	21	3	20	150	30	11		107,00 €	
	AEM90-AZ11-D21-C20-L180-Z03	21	3	20	180	50	11		138,00 €	
	AEM90-AZ11-D21-W20-L110-Z03	21	3	20	110	35	11		107,00 €	
	AEM90-AZ11-D22-C20-L150-Z02	22	2	20	150	30	11		107,00 €	
	AEM90-AZ11-D25-C24-L180-Z04	25	4	24	180	50	11		184,00 €	
	AEM90-AZ11-D25-W25-L110-Z04	25	4	25	110	40	11		162,00 €	
	AEM90-AZ11-D26-C25-L250-Z02	26	2	25	250	50	11		239,00 €	
	AEM90-AZ11-D26-W25-L120-Z03	28	3	25	180	30	11		114,00 €	
	AEM90-AZ11-D26-W25-L120-Z04	26	3	25	120	40	11		151,00 €	
	AEM90-AZ11-D28-C25-L180-Z03	26	4	25	120	50	11		171,00 €	
	AEM90-AZ11-D28-C25-L250-Z02	28	2	25	250	50	11		239,00 €	
	AEM90-AZ11-D33-W32-L130-Z04	33	4	32	130	50	11		130,00 €	
90°										

END MILLS / WP - SCHAFTFRÄSER

	CODE / TYP	TOOL DIMENSIONS (mm) <small>MAS</small>						CUTTING INSERT WENDE PLATTE	PRICE / PREIS
		DC	ZEFP	DCON	LF	LH	APMX		
	AEM90-BD11T3-D16-C15-L180-Z02	16	2	16	100	30	10		134,00 €
	AEM90-BD11T3-D16-C16-L100-Z02-H	16	2	16	100	30	10		102,00 €
	AEM90-BD11T3-D16-W16-L100-Z02-H	16	2	16	150	50	10		102,00 €
	AEM90-BD11T3-D16-W16-L150-Z02	16	2	15	180	50	10		102,00 €
	AEM90-BD11T3-D16-C16-L160-Z02-H	16	2	16	160	50	10		123,00 €
	AEM90-BD11T3-D17-W16-L150-Z02	17	2	16	150	25	10		114,00 €
	AEM90-BD11T3-D17-C16-L180-Z02	17	2	16	180	50	10		151,00 €
	AEM90-BD11T3-D18-W16-L100-Z02	18	2	16	100	25	10		102,00 €
	AEM90-BD11T3-D18-W16-L100-Z02-H	18	2	16	100	25	10		102,00 €
	<small>New</small> AEM90-BD11T3-D20-W16-L61-Z03	20	3	16	61	26	10		123,00 €
	AEM90-BD11T3-D20-W20-L81-Z03-H	20	3	20	81	30	10		123,00 €
	AEM90-BD11T3-D20-W20-L100-Z02-H	20	2	20	100	30	10		102,00 €
	AEM90-BD11T3-D20-W20-L100-Z03-H	20	3	20	100	30	10		123,00 €
	AEM90-BD11T3-D20-C20-L110-Z03-H	20	3	20	110	30	10	BDMT 11T3..	123,00 €
	AEM90-BD11T3-D20-W20-L150-Z02	20	2	20	150	50	10	FOR KYCR INSERT.	102,00 €
	AEM90-BD11T3-D20-W20-L150-Z03	20	3	20	150	50	10		123,00 €
	AEM90-BD11T3-D20-C20-L170-Z03-H	20	3	20	170	50	10		166,00 €
	AEM90-BD11T3-D21-W20-L150-Z03	21	3	20	150	25	10		131,00 €
	AEM90-BD11T3-D20-W20-L150-Z03-H	20	3	20	150	50	10		146,00 €
	AEM90-BD11T3-D21-C20-L200-Z02	21	2	20	200	25	10		187,00 €
	AEM90-BD11T3-D22-W20-L090-Z02-H	22	2	20	90	25	10		108,00 €
	<small>New</small> AEM90-BD11T3-D22-W20-L100-Z03-H	22	3	20	100	30	10		127,00 €
	AEM90-BD11T3-D25-W25-L100-Z03-H	25	3	25	100	30	10		127,00 €
	AEM90-BD11T3-D25-C20-L120-Z03-H	25	3	20	120	30	10		127,00 €
	AEM90-BD11T3-D25-C25-L120-Z03-H	25	3	25	120	30	10		127,00 €
	AEM90-BD11T3-D25-W25-L150-Z03	25	3	25	150	50	10		127,00 €
	AEM90-BD11T3-D26-W25-L150-Z03	26	3	25	150	35	10		131,00 €
	AEM90-BD11T3-D26-C25-L250-Z02	26	2	25	250	35	10		282,00 €
	AEM90-BD11T3-D32-W32-L110-Z04-H	32	4	32	110	40	10		146,00 €
	AEM90-BD11T3-D32-C32-L130-Z04-H	32	4	32	130	40	10		146,00 €
	AEM90-BD11T3-D32-W32-L150-Z04	32	4	32	150	50	10		146,00 €
	AEM90-BD11T3-D40-W32-L110-Z04-H	40	4	32	110	35	10		192,00 €
AEM90-BD1704-D25-W25-L100-Z02-H	25	2	25	100	35	15.7		127,00 €	
AEM90-BD1704-D25-W25-L150-Z02	25	2	25	150	50	15.7	BDMT 1704..	127,00 €	
AEM90-BD1704-D25-C25-L210-Z02-H	25	2	25	210	100	15.7	FOR KYCR INSERT.	212,00 €	
AEM90-BD1704-D32-W32-L110-Z03-H	32	3	32	110	40	15.7		146,00 €	
AEM90-BD1704-D32-C32-L130-Z03-H	32	3	32	130	50	15.7		146,00 €	
AEM90-BD1704-D32-W32-L130-Z03-H	32	3	32	130	40	15.7		146,00 €	
AEM90-BD1704-D32-W32-L150-Z03	32	3	32	150	40	15.7		146,00 €	
AEM90-BD1704-D40-W32-L110-Z04-H	40	4	32	110	40	15.7		167,00 €	
AEM90-BD1704-D40-W32-L150-Z04	40	4	32	150	40	15.7		167,00 €	
	AEM90-ED10T3-D16-W16-L120-Z02	16	2	16	120	30	10	EDPT 10T3..	131,00 €
	AEM90-ED10T3-D20-W20-L120-Z02	20	2	20	120	30	10	FOR KNMTL INSERT.	131,00 €
	AEM90-ED1404-D20-W20-L150-Z02	20	2	20	150	50	14.5	EDPT 1404..	131,00 €
	AEM90-ED1404-D25-W25-L150-Z02	25	2	25	150	50	14.5	FOR KNMTL INSERT.	144,00 €
	AEM90-ED1404-D30-C25-L150-Z03	30	3	25	150	50	14.5		187,00 €

90°

90°

END MILLS / WP - SCHAFTFRÄSER

	CODE / TYP	TOOL DIMENSIONS (mm) MAß						CUTTING INSERT WENDE PLATTE	PRICE / PREIS
		DC	ZEFP	DCON	LF	LH	APMX		
 90°	AEM90-LN08-D16-W16-L100-Z02-H	16	2	16	100	28	8		151,00 €
	AEM90-LN08-D16-W16-L150-Z02	16	2	16	150	40	8	LNMT 0804..	151,00 €
	AEM90-LN08-D20-W20-L100-Z03-H	20	3	20	100	28	8	FOR ISCR	180,00 €
	AEM90-LN08-D25-W25-L100-Z03-H	25	3	25	100	30	8	INSERT.	192,00 €
	AEM90-LN08-D32-W32-L110-Z05-H	32	5	32	110	30	8		222,00 €
	NEW AEM90-LN1306-D32-W32-L150-Z03	32	3	32	150	50	12.5	LNMT 1306..	162,00 €
	NEW AEM90-LN1306-D32-C32-L110-Z03-H	36	3	32	110	40	12.5	FOR ISCR INSERT.	175,00 €
 90°	AEM90-LN15T6-D25-W25-L150-Z02-H	25	2	25	150	50	15.5	LNGU 15T6..	144,00 €
	AEM90-LN15T6-D32-W32-L150-Z03-H	32	3	32	150	50	15.5	FOR KNMTL	167,00 €
	AEM90-LN15T6-D40-W32-L150-Z03-H	40	3	32	150	40	15.5	INSERT.	182,00 €
 90°	AEM90-LN1006-D16-W16-L120-Z01-H	16	1	16	120	30	9		124,00 €
	AEM90-LN1006-D16-W16-L150-Z01	16	1	16	150	50	9		124,00 €
	AEM90-LN1006-D18-W16-L120-Z02-H	18	2	16	120	30	9		129,00 €
	AEM90-LN1006-D20-W20-L120-Z02-H	20	2	20	120	30	9	LN.X 1006..	129,00 €
	AEM90-LN1006-D20-W20-L150-Z02	20	2	20	150	50	9	FOR KRLY	129,00 €
	AEM90-LN1006-D25-W25-L120-Z03-H	25	3	25	120	30	9	INSERT.	146,00 €
	AEM90-LN1006-D25-W25-L150-Z03	25	3	25	150	50	9		146,00 €
	AEM90-LN1006-D32-W32-L120-Z04-H	32	4	32	120	30	9		170,00 €
	AEM90-LN1006-D32-W32-L150-Z04	32	4	32	150	50	9		170,00 €
 90°	AEM90-LN1106-D25-W25-L150-Z03	25	3	25	150	40	10	LNMT 1106..	164,00 €
	AEM90-LN1106-D32-W32-L150-Z04	32	4	32	150	40	10	FOR ISCR-XTC-GSC	189,00 €
	AEM90-LN1106-D40-W32-L150-Z05	40	5	32	150	40	10	INSERT.	215,00 €

Cutting Calculation : P 166 / Schnittdatenberechnung : S 166



Ordering Example/Beispiel Bestellformular: 1pcs. AEM90-LN08-D16-W16-L100-Z02-H



END MILLS / WP - SCHAFTFRÄSER

	CODE / TYP	TOOL DIMENSIONS (mm) <small>MAß</small>						CUTTING INSERT WENDE PLATTE	PRICE / PREIS
		DC	ZEPF	DCON	LF	LH	APMX		
	AEM90-R390.11-D12-W12-L100-Z01	12	1	12	100	25	99		96,00 €
	AEM90-R390.11-D16-W16-L100-Z02-H	16	2	16	100	30	10		107,00 €
	AEM90-R390.11-D16-W16-L150-Z02	16	2	16	150	50	10		107,00 €
	AEM90-R390.11-D16-W16-L150-Z02-H	16	2	16	150	50	10		125,00 €
	AEM90-R390.11-D20-W20-L090-Z02-H	20	2	20	90	30	10		102,00 €
	AEM90-R390.11-D20-W20-L100-Z03-H	20	3	20	100	30	10		125,00 €
	AEM90-R390.11-D20-W20-L150-Z03	20	3	20	150	50	10	R390-11T3..	125,00 €
	AEM90-R390.11-D20-W20-L150-Z03-H	20	3	20	150	50	10	FOR SNDVK	142,00 €
	AEM90-R390.11-D20-C20-L150-Z03	20	3	20	150	30	10	INSERT.	125,00 €
	AEM90-R390.11-D22-W20-L090-Z02-H	22	2	20	90	30	10		102,00 €
	AEM90-R390.11-D25-C20-L150-Z03	25	3	20	150	40	10		125,00 €
	AEM90-R390.11-D25-W25-L100-Z03-H	25	3	25	100	30	10		125,00 €
	AEM90-R390.11-D25-W25-L150-Z03	25	3	25	150	50	10		125,00 €
	AEM90-R390.11-D25-W25-L150-Z03-H	25	3	25	150	50	10		142,00 €
	AEM90-R390.11-D30-W25-L150-Z04-H	30	4	25	150	30	10		173,00 €
	AEM90-R390.11-D32-C25-L200-Z03	32	3	25	200	40	10		192,00 €
	AEM90-R390.11-D32-W32-L150-Z05-H	32	5	32	150	50	10		193,00 €
	AEM90-R390.17-D25-W25-L150-Z02	25	2	25	150	50	15.4	R390-1704..	125,00 €
	AEM90-R390.17-D25-W25-L150-Z02-H	25	2	25	150	50	15.4	FOR SNDVK	142,00 €
	AEM90-R390.17-D30-W25-L150-Z03	30	3	25	150	40	15.4	INSERT.	142,00 €
AEM90-R390.17-D30-W25-L150-Z03-H	30	3	25	150	40	15.4		165,00 €	
AEM90-R390.17-D32-W32-L150-Z03-H	32	3	32	150	40	15.4	R390-1806..	165,00 €	
AEM90-R390.18-D32-C32-L150-Z03	32	3	32	150	45	15.4	FOR SNDVK INSERT.	142,00 €	
	AEM90-SE09-D25-C25-L120-Z03-H	25	3	25	120	60	6.7	SEET 09T3..	120,00 €
	AEM90-SE09-D25-C25-L150-Z02	25	2	25	150	50	6.7	FOR ZCC	102,00 €
	AEM90-SE09-D32-C32-L120-Z04-H	32	4	32	120	60	6.7	INSERT.	139,00 €
	AEM90-SE09-D32-C32-L150-Z03	32	3	32	150	50	6.7		120,00 €
	AEM90-L009-D16-C16-L160-Z02-H	16	2	16	160	60	8	LOGU 0904..	166,00 €
	AEM90-L009-D18-C16-L160-Z02-H	18	2	16	160	25	8	FOR MTSBH	166,00 €
	AEM90-L009-D20-C20-L160-Z03-H	20	3	20	160	60	8	INSERT.	199,00 €
	AEM90-L009-D20-W20-L100-Z03-H	20	3	20	100	30	8		172,00 €
	AEM90-L009-D22-C20-L160-Z03-H	22	3	20	160	30	8		199,00 €
	AEM90-L009-D25-C25-L160-Z04-H	25	4	25	160	70	8		212,00 €
	AEM90-L009-D25-W25-L091-Z03-H	25	3	25	91	30	8		150,00 €
	AEM90-L009-D32-C32-L160-Z05-H	32	5	32	160	70	8		241,00 €
	AEM90-L010-D16-W16-L100-Z02	16	2	16	100	30	10	LOMU 1004..	112,00 €
	AEM90-L010-D16-W16-L160-Z02	16	2	16	160	50	10	FOR KYCR	126,00 €
	AEM90-L010-D20-W20-L130-Z03	20	3	20	130	40	10	INSERT.	133,00 €
	AEM90-L010-D25-W25-L150-Z03	25	3	25	150	50	10		133,00 €
	AEM90-L010-D32-W32-L150-Z04	32	4	32	150	50	10		156,00 €

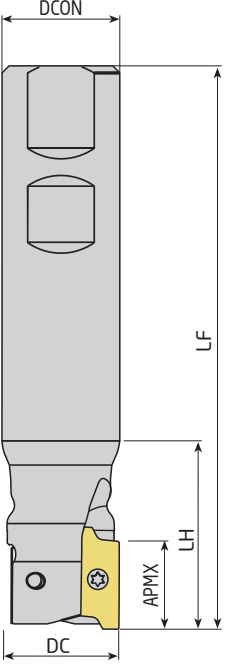
END MILLS / WP - SCHAFTFRÄSER

	CODE / TYP	TOOL DIMENSIONS (mm) Maß						CUTTING INSERT WENDE PLATTE	PRICE / PREIS
		DC	ZEFP	DCON	LF	LH	APMX		
  90°	AEM90-RT07-D10-W10-L120-Z02	10	2	10	120	30	7	RT 0702..	97,00 €
	AEM90-RT07-D12-W12-L120-Z02	12	2	12	120	30	7	FOR SFTY	97,00 €
	AEM90-RT07-D12-C12-L120-Z02	12	2	12	120	30	7	INSERT.	97,00 €
	AEM90-RT07-D14-W12-L120-Z02	14	2	12	120	30	7		97,00 €
	AEM90-RT10-D16-W16-L120-Z02-H	16	2	15	160	30	10		97,00 €
	AEM90-RT10-D16-W16-L150-Z02	16	2	16	120	30	10		97,00 €
	AEM90-RT10-D16-C15-L160-Z02	16	2	16	150	50	10		120,00 €
	AEM90-RT10-D16-C16-L200-Z02	16	2	16	200	100	10		142,00 €
	AEM90-RT10-D17-W16-L160-Z02	17	2	16	160	30	10		120,00 €
	AEM90-RT10-D17-C16-L200-Z02	17	2	16	200	30	10		131,00 €
	AEM90-RT10-D18-W16-L120-Z02-H	18	2	16	120	30	10		97,00 €
	AEM90-RT10-D20-W20-L120-Z03-H	20	3	19	200	30	10		119,00 €
	AEM90-RT10-D20-W20-L150-Z03	20	3	20	120	30	10		119,00 €
	AEM90-RT10-D20-C19-L200-Z03	20	3	20	150	50	10		192,00 €
	AEM90-RT10-D20-C20-L110-Z03	20	3	20	110	30	10	RT 1003..	119,00 €
	AEM90-RT10-D20-C20-L200-Z03	20	3	20	200	100	10	FOR SFTY	167,00 €
	AEM90-RT10-D21-W20-L200-Z03	21	3	20	200	30	10	INSERT.	198,00 €
	AEM90-RT10-D22-W20-L120-Z03-H	22	3	20	120	30	10		119,00 €
	AEM90-RT10-D22-C20-L150-Z03	22	3	20	150	30	10		119,00 €
	AEM90-RT10-D22-C20-L200-Z03	22	3	20	200	30	10		198,00 €
	AEM90-RT10-D25-W25-L120-Z04-H	25	4	25	120	40	10		130,00 €
	AEM90-RT10-D25-W25-L150-Z04	25	4	25	150	50	10		130,00 €
	AEM90-RT10-D25-C25-L200-Z04	25	4	25	200	100	10		179,00 €
	AEM90-RT10-D26-C25-L250-Z04	26	4	25	250	32	10		227,00 €
	AEM90-RT10-D32-W32-L120-Z05-H	32	5	32	120	50	10		142,00 €
	AEM90-RT10-D32-W32-L150-Z05	32	5	32	150	50	10		142,00 €
	AEM90-RT10-D32-C32-L200-Z05	32	5	32	200	100	10		189,00 €
	AEM90-RT10-D33-C32-L250-Z04	33	4	32	250	32	10		263,00 €
	AEM90-RT13-D32-C32-L250-Z04	32	4	32	250	50	13	RT 1304..	263,00 €
	AEM90-RT16-D25-W25-L120-Z02-H	25	2	25	120	40	16		119,00 €
	AEM90-RT16-D25-W25-L150-Z02	25	2	25	150	50	16		119,00 €
	AEM90-RT16-D25-C25-L200-Z02	25	2	25	200	100	16		167,00 €
	AEM90-RT16-D32-W32-L120-Z03-H	32	3	32	120	50	16		130,00 €
	AEM90-RT16-D32-W32-L150-Z03	32	3	32	150	50	16	RT 1606..	130,00 €
	AEM90-RT16-D32-C32-L200-Z03	32	3	32	200	100	16	FOR SFTY	179,00 €
	AEM90-RT16-D32-C32-L250-Z03	32	3	32	250	100	16	INSERT.	214,00 €
	AEM90-RT16-D32-C32-L270-Z03	32	3	32	270	100	16		225,00 €
	AEM90-RT16-D40-W32-L120-Z04-H	40	4	32	120	50	16		142,00 €
	AEM90-RT16-D40-W32-L150-Z04	40	4	32	150	50	16		142,00 €
	AEM90-RT16-D40-C32-L200-Z04	40	4	32	200	100	16		189,00 €
 90°	AEM90-VC2205-D32-C25-L150-Z02-H	32	2	25	150	50	15	VCKT 2205..	157,00 €
	AEM90-VC2205-D40-C32-L150-Z03-H	40	3	32	150	50	15	FOR KRLY	180,00 €
								INSERT.	

END MILLS / WP - SCHAFTFRÄSER

	CODE / TYP	TOOL DIMENSIONS (mm) <i>MAß</i>						CUTTING INSERT WENDE PLATTE	PRICE / PREIS
		DC	ZEFP	DCON	LF	LH	APMX		
 90°	AEM90-SO0803-D20-C16-L110-Z02-H	20	2	16	110	25	7	SOMT 0803..	129,00 €
	AEM90-SO0803-D25-C20-L110-Z02-H	25	2	20	110	25	7	FOR SMTM	140,00 €
	AEM90-SO0803-D32-C25-L120-Z03-H	32	3	25	120	30	7	INSERT.	172,00 €
 90°	AEM90-SPGT0602-D16-W16-L150-Z02	16	2	16	150	50	5.5	SPGT 0602..	140,00 €
	AEM90-SPGT07T3-D20-W20-L150-Z03	20	3	20	150	50	7	SPGT 07T3..	156,00 €
	AEM90-SPGT07T3-D25-W25-L150-Z03	25	3	25	150	50	7	FOR ZCC INSERT.	167,00 €
	AEM90-SPGT0904-D30-W32-L150-Z03	30	3	32	150	50	9	SPGT 0904.. FOR ZCC INSERT.	171,00 €
 90°	NEW AEM90-TNG10-D20-W20-L90-Z02-H	20	2	20	90	32	5		131,00 €
	NEW AEM90-TNG10-D20-W20-L90-Z03-H	20	3	20	90	32	5		152,00 €
	AEM90-TNG10-D20-C20-L125-Z02-H	20	2	20	125	29	5		157,00 €
	AEM90-TNG10-D20-C20-L125-Z03-H	20	3	20	125	29	5		186,00 €
	AEM90-TNG10-D20-C20-L150-Z03-H	20	3	20	150	50	5		225,00 €
	AEM90-TNG10-D25-C25-L150-Z03-H	25	3	25	150	34	5		225,00 €
	AEM90-TNG10-D21-C20-L200-Z03-H	21	3	20	200	30	5		292,00 €
	NEW AEM90-TNG10-D25-W25-L100-Z03-H	25	4	25	100	42	5		186,00 €
	NEW AEM90-TNG10-D25-W25-L100-Z04-H	25	3	25	150	34	5		204,00 €
	AEM90-TNG10-D25-C25-L150-Z04-H	25	4	25	150	34	5		254,00 €
	AEM90-TNG10-D25-C25-L170-Z04-H	25	4	25	170	50	5	TNGX 1004..	288,00 €
	AEM90-TNG10-D26-C25-L250-Z04-H	26	4	25	250	35	5	FOR PRMT INSERT.	409,00 €
	NEW AEM90-TNG10-D28-W25-L100-Z04-H	28	4	25	100	29	5		204,00 €
	AEM90-TNG10-D32-W32-L110-Z04-H	32	4	32	110	42	5		222,00 €
	NEW AEM90-TNG10-D32-W32-L110-Z05-H	32	5	32	110	42	5		239,00 €
	AEM90-TNG10-D32-C32-L170-Z04-H	32	4	32	170	37	5		316,00 €
	AEM90-TNG10-D32-C32-L170-Z05-H	32	5	32	170	37	5		345,00 €
	AEM90-TNG10-D33-C32-L250-Z05-H	33	5	32	250	35	5		444,00 €
	NEW AEM90-TNG16-D25-C25-L170-Z02-H	25	2	25	170	34	10		241,00 €
	NEW AEM90-TNG16-D25-C25-L170-Z02-H-80	25	2	25	170	80	10		241,00 €
	NEW AEM90-TNG16-D25-W25-L110-Z02-H	25	2	25	110	42	10	TNGX 1004..	113,00 €
NEW AEM90-TNG16-D32-C32-L195-Z02-H	32	2	32	195	34	10	FOR PRMT INSERT.	305,00 €	
NEW AEM90-TNG16-D32-C32-L195-Z02-H-80	32	2	32	195	80	10		305,00 €	
NEW AEM90-TNG16-D32-C32-L195-Z03-H	32	3	32	195	34	10		329,00 €	
NEW AEM90-TNG16-D32-W32-L110-Z03-H	32	3	32	110	42	10		228,00 €	
NEW AEM90-TNG16-D35-C32-L195-Z04-H	35	4	32	195	34	10		357,00 €	
NEW AEM90-TNG16-D40-W32-L120-Z04-H	40	4	32	120	50	10		275,00 €	
 90°	NEW AEM90-WNG04-D20-W20-L81-Z02-H	20	2	20	81	31	4		116,00 €
	AEM90-WNG04-D20-W20-L81-Z03-H	20	3	20	81	31	4		129,00 €
	NEW AEM90-WNG04-D20-C20-L170-Z02-H	20	2	20	170	50	4		153,00 €
	AEM90-WNG04-D20-C20-L170-Z03-H	20	3	20	170	50	4	WNGU 0403..	165,00 €
	AEM90-WNG04-D25-W25-L88-Z03-H	25	3	25	88	32	4	FOR XTC-GSC INSERT.	133,00 €
	AEM90-WNG04-D25-W25-L88-Z04-H	25	4	25	88	32	4		141,00 €
	NEW AEM90-WNG04-D25-C25-L170-Z02-H	25	2	25	170	50	4		182,00 €
	AEM90-WNG04-D25-C25-L170-Z03-H	25	3	25	170	50	4		199,00 €
	AEM90-WNG04-D32-W25-L100-Z05-H	32	5	25	100	35	4		158,00 €
	AEM90-WNG04-D32-W32-L100-Z05-H	32	5	32	100	40	4		158,00 €
	NEW AEM90-WNG04-D32-C32-L170-Z03-H	32	3	32	170	50	4		199,00 €
	AEM90-WNG04-D32-C25-L170-Z04-H	32	4	25	170	35	4		211,00 €
	AEM90-WNG04-D32-C32-L170-Z04-H	32	4	32	170	50	4		211,00 €
	NEW AEM90-WNG08-D32-C32-L170-Z02-H	32	2	32	170	50	7.5	WNGU 0806..	199,00 €
	AEM90-WNG08-D40-W32-L100-Z03-H	40	3	32	100	35	7.5	FOR XTC-GSC INSERT.	187,00 €
	NEW AEM90-WNG08-D40-W40-L110-Z03-H	40	3	40	110	40	7.5		187,00 €
AEM90-WNG08-D40-C32-L170-Z03-H	40	3	32	170	35	7.5		258,00 €	



END MILLS / WP - SCHAFTFRÄSER

	CODE / TYP	TOOL DIMENSIONS (mm) <small>MAß</small>						CUTTING INSERT WENDE PLATTE	PRICE / PREIS
		DC	ZFP	DCON	LF	LH	APMX		
 90°	AEM90L-WN0604Z-D25-C25-L200-Z02-H	25	2	25	200	100	5.7	WNHU 0604..	207,00 €
	AEM90-WN0604Z-D25-W25-L150-Z02-H	25	2	25	150	50	5.7	FOR ZCC	155,00 €
	AEM90-WN0604Z-D32-W32-L150-Z03-H	32	3	32	150	50	5.7	INSERT.	170,00 €
	AEM90-WN0604Z-D40-W32-L150-Z04-H	40	4	32	150	35	5.7		194,00 €
 90°	AEM90-XC13-D20-W20-L150-Z02	20	2	20	150	60	13	XCKX 13T3..	114,00 €
	AEM90-XC13-D25-W25-L150-Z03	25	3	25	150	60	13	FOR SC	119,00 €
	AEM90-XC13-D32-W32-L150-Z04	32	4	32	150	60	13	INSERT.	137,00 €
 90°	AEM90-XD11T3-D16-W16-L150-Z02	16	2	16	150	40	10		107,00 €
	AEM90-XD11T3-D17-C16-L150-Z02	17	2	16	150	30	10		107,00 €
	AEM90-XD11T3-D20-W20-L150-Z03	20	3	20	150	50	10	XD.T 11T3..	125,00 €
	AEM90-XD11T3-D21-C20-L080-Z03-H	21	3	20	80	25	10	FOR CRTZT	125,00 €
	AEM90-XD11T3-D21-C20-L150-Z03	21	3	20	150	30	10	INSERT.	125,00 €
	AEM90-XD11T3-D25-W25-L150-Z04	25	4	25	150	50	10		141,00 €
	AEM90-XD11T3-D30-W25-L120-Z04	30	4	25	120	30	10		145,00 €
	AEM90-XD11T3-D32-W32-L150-Z04	32	4	32	150	50	10		145,00 €
	AEM90-XD11T3-D33-C20-L080-Z04-H	33	4	20	80	30	10		145,00 €
 90°	AEM90-XN0403-D16-C16-L100-Z01-H	16	1	16	100	30	4	XNEX 0403..	116,00 €
	AEM90-XN0403-D22-C20-L110-Z03-H	22	3	20	110	30	4	FOR SC INSERT	134,00 €
	AEM90-XN0806-D32-C32-L110-Z02-H	32	2	32	110	40	7.5	XNEX 0806.. FOR SC INSERT.	148,00 €
 90°	AEM90-X006-D10-C12-L120-Z02	10	2	12	120	50	5	XO.. 0602..	157,00 €
	AEM90-X006-D12-C12-L120-Z02	12	2	12	120	25	5	FOR SC INSERT.	157,00 €
	AEM90-X009-D16-W16-L150-Z02	16	2	16	150	50	8	XO.. 0903..	119,00 €
	AEM90-X009-D20-W20-L150-Z03	20	3	20	150	50	8	FOR SC INSERT.	134,00 €
	AEM90-X012-D20-W20-L150-Z02	20	2	20	150	50	11		107,00 €
	AEM90-X012-D20-C20-L200-Z02	20	2	20	200	100	11		165,00 €
	AEM90-X012-D22-W20-L150-Z02	22	2	20	150	20	11	XO.. 1204..	107,00 €
	AEM90-X012-D25-W25-L150-Z03	25	3	25	150	50	11	FOR SC	119,00 €
	AEM90-X012-D25-C25-L200-Z03	25	3	25	200	100	11	INSERT.	182,00 €
	AEM90-X012-D32-C25-L150-Z04	32	4	25	150	40	11		137,00 €
	AEM90-X012-D32-W32-L150-Z04	32	4	32	150	50	11		137,00 €
	AEM90-X012-D32-C32-L250-Z04	32	4	32	250	100	11		354,00 €

END MILLS / WP - SCHAFTFRÄSER

	CODE / TYP	TOOL DIMENSIONS (mm) <small>MAß</small>						CUTTING INSERT WENDE PLATTE	PRICE / PREIS
		DC	ZEPF	DCON	LF	LH	APMX		
	AEM90-ZC1003-D16-C14-L150-Z02	16	2	14	150	25	9		93,00 €
	AEM90-ZC1003-D16-C14-L200-Z02	16	2	14	200	25	9		140,00 €
	AEM90-ZC1003-D16-C15-L150-Z02	16	2	15	150	25	9		93,00 €
	AEM90-ZC1003-D16-C16-L150-Z02	16	2	16	150	25	9		93,00 €
	AEM90-ZC1003-D16-C16-L200-Z02	16	2	16	200	50	9		139,00 €
	AEM90-ZC1003-D17-C16-L150-Z02	17	2	16	150	25	9		93,00 €
	AEM90-ZC1003-D17-C16-L200-Z02	17	2	16	200	25	9		139,00 €
	AEM90-ZC1003-D20-C18-L150-Z03	20	3	18	150	25	9	ZCMT 100308R	107,00 €
	AEM90-ZC1003-D20-C18-L200-Z02	20	2	18	200	25	9	FOR DJT	155,00 €
	AEM90-ZC1003-D20-C20-L150-Z03	20	3	20	150	40	9	INSERT.	107,00 €
	AEM90-ZC1003-D20-C18-L200-Z03	20	3	18	200	25	9		162,00 €
	AEM90-ZC1003-D21-C20-L150-Z02	21	2	20	150	30	9		93,00 €
	AEM90-ZC1003-D21-C20-L150-Z03	21	3	20	150	30	9		107,00 €
	AEM90-ZC1003-D21-C20-L200-Z03	21	3	20	200	30	9		168,00 €
	AEM90-ZC1003-D25-C20-L150-Z03	25	3	20	150	30	9		107,00 €
	AEM90-ZC1003-D25-C20-L200-Z03	25	3	20	200	30	9		167,00 €
	AEM90-ZC1003-D25-C25-L150-Z03	25	3	25	150	40	9		107,00 €
	AEM90-ZC1003-D26-C25-L170-Z03	26	3	25	170	25	9		121,00 €
	AEM90-ZC1003-D26-C25-L200-Z03	26	3	25	200	25	9		162,00 €
AEM90-ZC1003-D32-C25-L180-Z04	32	4	25	180	30	9		174,00 €	
AEM90-ZC1003-D33-C32-L200-Z04	33	4	32	200	25	9		182,00 €	
	AEM90-ZP13T3-D26-C25-L200-Z02	26	2	25	200	35	13		154,00 €
	AEM90-ZP13T3-D26-C25-L200-Z03	26	3	25	200	35	13	ZPMT 13T3..	162,00 €
	AEM90-ZP13T3-D26-C25-L250-Z02	26	2	25	250	35	13	FOR DJT	215,00 €
	AEM90-ZP13T3-D33-C32-L200-Z03	33	3	32	200	40	13	INSERT.	182,00 €
	AEM90-ZP13T3-D33-C32-L250-Z03	33	3	32	250	40	13		240,00 €
	NEW AEM90-3P0603-D12-C12-L120-Z01-H	12	1	12	120	25	4.7	3P.T 0603	96,00 €
	AEM90-3P0603-D16-W16-L120-Z03-H	16	3	16	120	25	4.7	FOR TGTC	160,00 €
	AEM90-3P0603-D20-W20-L150-Z03-H	20	3	20	150	25	4.7	INSERT.	174,00 €
	AEM90-3P0603-D25-W25-L150-Z05-H	25	5	25	150	25	4.7		216,00 €
	AEM90-3P1004-D20-W20-L150-Z02	20	2	20	150	40	7	3P.T 1004	127,00 €
	AEM90-3P1004-D21-C20-L200-Z02	21	2	20	200	30	7	FOR TGTC	189,00 €
	NEW AEM90-3P1004-D22-W20-L150-Z02	22	2	20	150	30	7	INSERT.	127,00 €
	AEM90-3P1004-D25-W25-L150-Z03	25	3	25	150	40	7		145,00 €
	AEM90-3P1505-D32-W32-L150-Z03	32	3	32	150	50	11	3P.T 1505	153,00 €
	AEM90-3P1505-D38-W32-L150-Z03	38	3	32	150	35	11	FOR TGTC	167,00 €
	AEM90-3P1505-D40-W32-L150-Z04	40	4	32	150	35	11	INSERT.	171,00 €
	AEM90-4N06-D16-W16-L120-Z02-H	16	2	16	120	25	6	4NKT 0603..	120,00 €
	AEM90-4N06-D16-W16-L160-Z02	16	2	16	160	25	6	FOR TGTC	120,00 €
	AEM90-4N06-D20-W16-L120-Z03-H	20	3	16	120	20	6	INSERT.	151,00 €
	AEM90-4N06-D20-W16-L160-Z03	20	3	16	160	20	6		151,00 €
	NEW AEM90-4N06-D20-W20-L160-Z03	20	3	20	160	25	6		151,00 €

S - SYSTEM FACE AND COPY END MILLS / S-SYSTEM KOPIER - UND SCHAFTFRÄSER

	CODE / TYP	TOOL DIMENSIONS (mm) MAB					CUTTING INSERT WENDE PLATTE	PRICE / PREIS
		DCX	ZEFP	DCON	LF	LH		
	AEMR-RP08T2M-D20-W20-L150-Z02-H	20	2	20	150	60	RPMT 08T2..	156,00 €
	AEMR-RP08T2M-D25-W25-L200-Z03-H	25	3	25	200	100	FOR MTSBSH INSERT.	239,00 €
	AEMR-RP10T3M-D25-W25-L200-Z02-H	25	2	25	200	100	RPMT 10T3..	210,00 €
	AEMR-RP10T3M-D32-W32-L200-Z03-H	32	3	32	200	100	FOR MTSBSH INSERT.	260,00 €
	NEW AEMR-RP1204M-D25-C25-L180-Z02	25	2	25	180	50		157,00 €
	NEW AEMR-RP1204M-D25-C25-L180-Z02-H	25	2	25	180	50	RPMT 1204..	187,00 €
	AEMR-RP1204M-D32-W32-L150-Z03-H	32	3	32	150	60	FOR MTSBSH INSERT.	173,00 €
	AEMR-RP1204M-D32-W32-L200-Z03-H	32	3	32	200	100		260,00 €
	NEW AEMR-RP1204M-D36-C25-L160-Z03	36	3	25	160	30		158,00 €
	AEMR-RP1606M-D40-W32-L150-Z02-H	40	2	16	150	35	RPMT 1606..	187,00 €
AEMR-RP1606M-D40-W32-L200-Z02-H	40	2	16	200	35	FOR MTSBSH INSERT.	281,00 €	
	AEMR-RY08-D16-W16-L150-Z02	16	16	2	150	55	RYMX 0803..	126,00 €
	AEMR-RY10-D20-W20-L150-Z02	20	20	2	150	60		138,00 €
	AEMR-RY10-D20-C20-L200-Z02	20	20	2	200	100	RYMX 1004..	185,00 €
	AEMR-RY10-D21-W20-L200-Z02-H	21	20	2	200	30	FOR TGTC INSERT.	222,00 €
	AEMR-RY10-D25-W25-L150-Z02	25	25	2	150	60		151,00 €
	AEMR-RY10-D26-W25-L200-Z02-H	26	25	2	200	60		267,00 €
	AEMR-RY10-D32-W32-L160-Z04-H	32	32	4	160	60		238,00 €
	AEMR-RY12-D32-C25-L160-Z03	32	25	3	160	30	RYMX 1205.. FOR TGTC INSERT.	184,00 €
	AEMR-QP10T3-D20-C20-L150-Z01-H	20	1	20	150	70		157,00 €
	AEMR-QP10T3-D25-C25-L120-Z02-H	25	2	25	120	40		183,00 €
	AEMR-QP10T3-D25-C25-L150-Z02-H	25	2	25	150	70	QP. 10T3..	183,00 €
	AEMR-QP10T3-D25-C25-L170-Z02	25	2	25	170	90	FOR SMTM INSERT.	172,00 €
	AEMR-QP10T3-D32-C32-L150-Z03-H	32	3	32	150	70		210,00 €
	AEMR-QP10T3-D32-C32-L170-Z03	32	3	32	170	90		185,00 €
	AEMR-QP1204-D25-C25-L150-Z02-H	25	2	25	150	70	QP. 1204.. SMTM	183,00 €

Cutting Calculation : P 166 / Schnittdatenberechnung : S 166

Ordering Example/Beispiel Bestellformular: 1pcs. AEMR-RP08T2M-D20-W20-L150-Z02-H

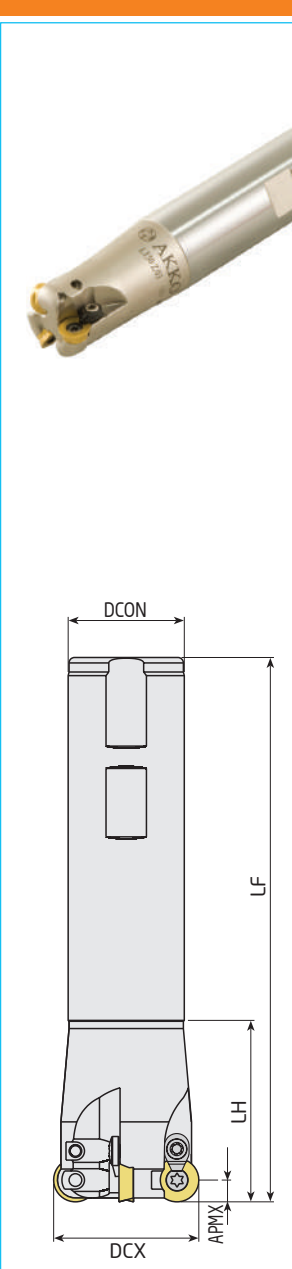

S - SYSTEM FACE AND COPY END MILLS / S-SYSTEM KOPIER - UND SCHAFTFRÄSER

	CODE / TYP	TOOL DIMENSIONS (mm) <small>MAß</small>					CUTTING INSERT <small>WENDE PLATTE</small>	PRICE / PREIS
		DCX	ZEFP	DCON	LF	LH		
	AEMR-RD0501-D08-W10-L100-Z01-H	8	1	10	100	20		110,00 €
	AEMR-RD0501-D10-W12-L100-Z02-H	10	2	12	100	20	RD.. 0501	125,00 €
	AEMR-RD0501-D12-W12-L120-Z02-H	12	2	12	120	20		125,00 €
	AEMR-RD0803-D16-W16-L150-Z02	16	2	16	150	60	RD.. 0803	99,00 €
	AEMR-RD0803-D16-C20-L200-Z02	16	2	20	200	60	FOR ISO INSERT.	154,00 €
	AEMR-RD0803-D20-W20-L150-Z03	20	3	20	150	60		146,00 €
	AEMR-RD08T2-D16-W16-L150-Z02	16	2	16	150	60	RD.. 08T2	99,00 €
	AEMR-RD08T2-D20-W20-L150-Z02	20	2	20	150	60	FOR ISO INSERT.	121,00 €
	AEMRC-RD1003-D20-W20-L150-Z02	20	2	20	150	60		121,00 €
	AEMRC-RD1003-D20-C20-L160-Z02	20	2	20	160	70		130,00 €
	AEMRC-RD1003-D20-C20-L250-Z02	20	2	20	250	150		219,00 €
	AEMRC-RD1003-D21-C20-L160-Z02	21	2	20	160	70		130,00 €
	AEMRC-RD1003-D25-W25-L150-Z02	25	2	25	150	60		121,00 €
	AEMRC-RD1003-D25-C25-L160-Z02	25	2	25	160	70		130,00 €
	AEMRC-RD1003-D25-W25-L200-Z02	25	2	25	200	100		165,00 €
	AEMRC-RD1003-D25-C25-L200-Z02	25	2	25	200	100	RD.. 1003	165,00 €
	AEMRC-RD1003-D25-C25-L250-Z02	25	2	25	250	150	FOR ISO INSERT.	219,00 €
	AEMRC-RD1003-D26-C25-L160-Z02	26	2	25	160	70		130,00 €
	AEMRC-RD1003-D32-W32-L150-Z03	32	3	32	150	60		137,00 €
	AEMRC-RD1003-D32-C32-L250-Z02	32	2	32	250	150		229,00 €
	AEMRC-RD1003-D33-C32-L160-Z03	33	3	32	160	70		146,00 €
	AEMRC-RD1003-D40-W32-L150-Z04	40	4	32	150	35		154,00 €
	AEMRC-RD1003-D40-C32-L250-Z02	40	2	32	250	50		240,00 €
	AEMRC-RD10T3-D20-C20-L150-Z02	20	2	20	150	60		121,00 €
	NEW AEMR-RD10T3-D20-C20-L180-Z02-H	20	2	20	180	60		196,00 €
	AEMRC-RD10T3-D20-W20-L150-Z02	20	2	20	150	60		121,00 €
	NEW AEMRC-RD10T3-D21-C20-L200-Z02-H	21	2	20	200	80	RD.. 10T3	197,00 €
	AEMRC-RD10T3-D25-C25-L150-Z02	25	2	25	150	60	FOR ISO INSERT.	121,00 €
	AEMRC-RD10T3-D25-C25-L200-Z02-H	25	2	25	150	60		197,00 €
	AEMRC-RD10T3-D25-W25-L150-Z02	32	3	32	150	60		121,00 €
	NEW AEMRC-RD10T3-D25-C32-L150-Z03	25	3	32	150	50		137,00 €
	NEW AEMRC-RD10T3-D26-C25-L200-Z02-H	26	2	25	200	35		202,00 €
	AEMRC-RD10T3-D32-C25-L250-Z03-H	25	2	25	150	60		299,00 €
	AEMRC-RD10T3-D32-W32-L150-Z03	25	2	25	200	100		137,00 €
	NEW AEMRC-RD10T3-D32-C32-L150-Z04	32	4	32	150	60		154,00 €
	AEMRC-RD12T3-D25-W25-L150-Z02	25	2	25	250	150		121,00 €
	AEMRC-RD12T3-D25-W25-L200-Z02	25	2	25	200	100	RD.. 12T3	165,00 €
	AEMRC-RD12T3-D25-C25-L250-Z02	25	2	25	300	200	FOR ISO INSERT.	219,00 €
	AEMRC-RD12T3-D25-C25-L300-Z02	32	3	32	150	60		292,00 €
	AEMRC-RD12T3-D32-W32-L150-Z03	32	2	32	250	150		137,00 €
AEMRC-RD12T3-D32-C32-L250-Z02	32	3	25	250	35		229,00 €	
AEMRC-RD12T3-D40-W32-L150-Z04	40	4	32	150	50		154,00 €	
AEMRC-RD12T3-D40-C32-L250-Z02	40	2	32	250	50		240,00 €	
NEW AEMRC-RD1204-D32-C32-L200-Z02	32	2	32	200	100	RD.. 12T3	184,00 €	
AEMRC-RD1204-D32-C32-L160-Z03	32	3	32	160	70	FOR ISO INSERT.	146,00 €	
AEMRC-RD1204-D32-W32-L160-Z03	32	3	32	160	50	RD.. 1604	146,00 €	
NEW AEMRC-RD1204-D32-C32-L200-Z02	32	2	32	200	100		184,00 €	
AEMRC-RD1204-D33-C32-L160-Z03	33	3	32	160	70	RD.. 1204 ISO	146,00 €	
AEMRC-RD1604-D40-W32-L150-Z02	40	2	32	150	35	RD.. 1604 ISO	142,00 €	

S - SYSTEM FACE AND COPY END MILLS / S-SYSTEM KOPIER - UND SCHAFTFRÄSER

	CODE / TYP	TOOL DIMENSIONS (mm) <small>MAß</small>					CUTTING INSERT WENDE PLATTE	PRICE / PREIS
		DCX	ZEFP	DCON	LF	LH		
	AEMR-RP10T3-D25-W25-L125-Z02	25	2	25	125	60	RPNX 10T3..	137,00 €
	AEMR-RP10T3-D25-W25-L150-Z02	25	2	25	150	60	FOR CRTZT	137,00 €
	AEMR-RP10T3-D32-W32-L150-Z03	32	3	32	150	60	INSERT.	155,00 €

S - SYSTEM HIGHFEED END MILLS / S - SYSTEM HOCHGESCHWINDIGKEITS

	CODE / TYP	TOOL DIMENSIONS (mm) <small>MAß</small>					CUTTING INSERT WENDE PLATTE	PRICE / PREIS
		DCX	ZEFP	DCON	LF	LH		
	AHFM-BN10T3-D16-C16-L100-Z02-H	16	2	16	100	30		126,00 €
	AHFM-BN10T3-D16-C16-L150-Z02-H	16	2	16	150	50		151,00 €
	AHFM-BN10T3-D20-C20-L130-Z03-H	20	3	20	130	40		170,00 €
	AHFM-BN10T3-D20-C20-L130-Z04-H	20	4	20	130	40		200,00 €
	AHFM-BN10T3-D20-C20-L160-Z03-H	20	3	20	160	80		242,00 €
	AHFM-BN10T3-D25-C25-L140-Z04-H	25	4	25	140	50	BNGX 10T3..	226,00 €
	AHFM-BN10T3-D25-W25-L140-Z04-H	25	4	25	140	50	FOR PRMT	226,00 €
	AHFM-BN10T3-D25-C25-L140-Z05-H	25	5	25	140	50	INSERT..	258,00 €
	AHFM-BN10T3-D25-C25-L180-Z04-H	25	4	25	180	100		340,00 €
	AHFM-BN10T3-D32-C32-L150-Z05-H	32	5	32	150	70		314,00 €
	AHFM-BN10T3-D32-C32-L150-Z06-H	32	6	32	150	70		345,00 €
AHFM-BN10T3-D35-C32-L200-Z06-H	35	6	32	200	50		454,00 €	
	AHFM-BL0603-D16-C15-L150-Z02	16	2	15	150	20		126,00 €
	AHFM-BL0603-D16-C16-L100-Z02-H	16	2	16	100	30		126,00 €
	AHFM-BL0603-D16-C16-L150-Z02	16	2	16	150	50		126,00 €
	AHFM-BL0603-D17-C16-L150-Z02	17	2	16	150	20		126,00 €
	AHFM-BL0603-D17-W16-L170-Z02	17	2	16	170	20		175,00 €
	AHFM-BL0603-D17-W16-L170-Z02-H	17	2	16	170	20		175,00 €
	AHFM-BL0603-D17-C16-L200-Z02	17	2	16	200	30		183,00 €
	AHFM-BL0603-D18-C16-L150-Z02	18	2	16	150	20		126,00 €
	AHFM-BL0603-D18-W16-L150-Z02-H	18	2	16	150	20		151,00 €
	AHFM-BL0603-D20-C20-L130-Z03	20	3	20	130	50	BLMP 0603..	142,00 €
	AHFM-BL0603-D20-C20-L160-Z03	20	3	20	160	50	FOR TGTC	166,00 €
	AHFM-BL0603-D21-W20-L200-Z03	21	3	20	200	25	INSERT.	237,00 €
	AHFM-BL0603-D22-W20-L150-Z03	22	3	20	150	25		166,00 €
	AHFM-BL0603-D21-C20-L200-Z03	21	3	20	200	20		237,00 €
	AHFM-BL0603-D25-C25-L250-Z04	25	4	25	250	40		390,00 €
	<small>NEW</small> AHFM-BL0603-D26-C25-L150-Z04	26	4	25	150	35		195,00 €
	AHFM-BL0603-D26-W25-L200-Z04	26	4	25	200	35		259,00 €
	AHFM-BL0603-D26-C25-L250-Z04	26	4	25	250	35		390,00 €
	AHFM-BL0603-D26-C25-L200-Z04	26	4	25	200	35		259,00 €
	AHFM-BL0603-D32-C32-L150-Z05	32	5	32	150	70		189,00 €
	AHFM-BL0603-D32-C32-L200-Z05	32	5	32	200	120		286,00 €
	AHFM-BL0603-D33-C32-L150-Z05	33	5	32	150	40		189,00 €
	AHFM-BL0603-D33-C32-L200-Z05	33	5	32	200	40		286,00 €
	AHFM-BL0603-D33-C32-L250-Z05	33	5	32	250	40		418,00 €
	<small>NEW</small> AHFM-BL0904-D28-W25-L180-Z03	28	3	25	180	30	BLMP 0603.. TGTC	210,00 €

S - SYSTEM HIGHFEED END MILLS / S - SYSTEM HOCHGESCHWINDIGKEITS

	CODE / TYP	TOOL DIMENSIONS (mm) <small>MAß</small>					CUTTING INSERT <small>WENDE PLATTE</small>	PRICE / PREIS
		DCX	ZEFP	DCON	LF	LH		
	AHFM-E00602-D10-C10-L080-Z02	10	2	10	80	20		117,00 €
	AHFM-E00602-D10-C09-L120-Z02	10	2	9	120	15		117,00 €
	AHFM-E00602-D10-C10-L120-Z02	10	2	10	120	60		117,00 €
	AHFM-E00602-D12-C12-L080-Z02	12	2	12	80	20	EO.. 0602..	117,00 €
	AHFM-E00602-D12-C12-L080-Z03	12	3	12	80	20	ZOMT 0602..	131,00 €
	AHFM-E00602-D12-C11-L120-Z02	12	2	11	120	15	FOR DJT	117,00 €
	AHFM-E00602-D12-C11-L120-Z03	12	3	11	120	15	INSERT.	131,00 €
	AHFM-E00602-D12-C12-L120-Z02	12	2	12	120	60		117,00 €
	AHFM-E00602-D12-C12-L120-Z03	12	3	12	120	60		131,00 €
	AHFM-E00602-D16-C16-L150-Z04	16	4	16	150	60		146,00 €
	AHFM-EP1003-D16-C16-L80-Z02-H	16	2	16	80	20	EP.. 1003..	100,00 €
	AHFM-EP1003-D16-C16-L150-Z02-H	16	2	16	150	50	ZPMT 1003..	100,00 €
	AHFM-EP1003-D17-C16-L150-Z02-H	17	2	16	150	20	YPHW 1003..	100,00 €
	AHFM-EP1003-D20-C20-L150-Z04-H	20	4	20	150	50	FOR DJT	138,00 €
	AHFM-EP1003-D21-C20-L150-Z04-H	21	4	20	150	20	INSERT.	138,00 €
	AHFM-EP1003-D25-C25-L200-Z04-H	25	4	25	200	100		207,00 €
	AHFM-EP1003-D25-C25-L250-Z04-H	25	4	25	250	100		310,00 €
	AHFM-EN1004-D16-C15-L150-Z02	16	2	15	150	25		110,00 €
	AHFM-EN1004-D16-C16-L150-Z02	16	2	16	150	25		110,00 €
	AHFM-EN1004-D16-C16-L200-Z02	16	2	16	200	25		164,00 €
	AHFM-EN1004-D16-C16-L250-Z02	16	2	16	250	25		167,00 €
	AHFM-EN1004-D17-C16-L150-Z02-H	17	2	16	150	25		130,00 €
	AHFM-EN1004-D17-C16-L150-Z02	17	2	16	150	25		110,00 €
	AHFM-EN1004-D17-C16-L200-Z02	17	2	16	200	25		164,00 €
	AHFM-EN1004-D18-C16-L150-Z02	18	2	16	150	25		110,00 €
	AHFM-EN1004-D20-C20-L150-Z03	20	3	20	150	40		130,00 €
	AHFM-EN1004-D20-C20-L250-Z03	20	3	20	250	70		292,00 €
	AHFM-EN1004-D21-C20-L150-Z02	21	2	20	150	30		116,00 €
	AHFM-EN1004-D21-C20-L150-Z03	21	3	20	150	30		156,00 €
	AHFM-EN1004-D21-C20-L150-Z03-H	21	3	20	150	30	ENMU 1004..	156,00 €
	AHFM-EN1004-D20-C20-L200-Z03	20	3	20	200	30	FOR DJT	195,00 €
	AHFM-EN1004-D21-C20-L200-Z03	21	3	20	200	30	INSERT.	195,00 €
	AHFM-EN1004-D22-C20-L150-Z03	22	3	20	150	30		130,00 €
	AHFM-EN1004-D25-C25-L150-Z03	25	3	25	150	40		130,00 €
	AHFM-EN1004-D25-C25-L150-Z04	25	4	25	150	40		143,00 €
	AHFM-EN1004-D26-C25-L150-Z03	26	3	25	150	30		130,00 €
	AHFM-EN1004-D26-C25-L150-Z04	26	4	25	150	30		143,00 €
	AHFM-EN1004-D26-C25-L200-Z03	26	3	25	200	30		195,00 €
	AHFM-EN1004-D26-C25-L200-Z03-H	26	3	25	200	30		233,00 €
	AHFM-EN1004-D26-C25-L250-Z03-H	26	3	25	250	30		349,00 €
	AHFM-EN1004-D28-C25-L200-Z04	28	4	25	200	30		266,00 €
	AHFM-EN1004-D32-C32-L200-Z04	32	4	32	200	30		266,00 €
	AHFM-EN1004-D33-C32-L200-Z04	33	4	32	200	50		318,00 €
	AHFM-EN1004-D33-C32-L200-Z04-H	33	4	32	200	30		318,00 €

S - SYSTEM HIGHFEED END MILLS / S - SYSTEM HOCHGESCHWINDIGKEITS

	CODE / TYP	TOOL DIMENSIONS (mm) <small>MAB</small>					CUTTING INSERT WENDE PLATTE	PRICE / PREIS
		DCX	ZEFP	DCON	LF	LH		
	AHFMC-JD1204-D32-C32-L150-Z02	32	2	32	150	50	JDMW 1204..	185,00 €
	AHFMC-JD1204-D32-C32-L200-Z02	32	2	32	200	50	FOR MTSBH	245,00 €
	AHFMC-JD1204-D35-C32-L200-Z02	35	2	32	200	50	INSERT.	256,00 €
	AHFMC-JD1204-D35-C32-L250-Z02	35	2	32	250	50		353,00 €
	AHFM-SP0735-D16-C16-L160-Z02-H	16	2	16	160	30	SPMX 073505	147,00 €
	AHFM-SP0735-D17-C16-L160-Z02-H	17	2	16	160	30	FOR MTSBH	147,00 €
	AHFM-SP0735-D20-C20-L160-Z03-H	20	2	20	160	30	INSERT.	179,00 €
	AHFM-SP0735-D21-C20-L160-Z03-H	21	2	20	160	30		223,00 €
	AHFM-LN0303-D16-C15-L150-Z02	16	2	15	150	30		146,00 €
	AHFM-LN0303-D16-W16-L150-Z02-H	16	2	16	150	50		175,00 €
	AHFM-LN0303-D17-C16-L150-Z02-H	17	2	16	150	30	LNMU 0303..	175,00 €
	AHFM-LN0303-D20-W20-L150-Z03-H	20	3	20	150	50	FOR TNGLY	204,00 €
	AHFM-LN0303-D21-C20-L150-Z03	21	3	20	150	30	INSERT.	170,00 €
	AHFM-LN0303-D25-W25-L150-Z04-H	25	4	25	150	50		243,00 €
	AHFM-LN0303-D26-C25-L150-Z04	26	4	25	150	30		202,00 €
	AHFM-LN0303-D28-C25-L180-Z03	28	3	25	180	30		210,00 €
AHFM-LN0303-D33-C32-L200-Z05	33	5	32	200	30		236,00 €	
	AHFM-L003-D16-C16-L100-Z02	16	2	15	160	30		121,00 €
	AHFM-L003-D16-C16-L100-Z02-F	16	2	16	100	30		182,00 €
	AHFM-L003-D16-C16-L130-Z02-H	16	2	16	100	30		137,00 €
	AHFM-L003-D16-C15-L160-Z02	16	2	16	130	40		146,00 €
	AHFM-L003-D16-C16-L160-Z02	16	2	16	160	50		151,00 €
	AHFM-L003-D16-C16-L160-Z02-H	16	2	16	160	100		151,00 €
	AHFM-L003-D17-C16-L180-Z02	17	2	16	180	30		182,00 €
	AHFM-L003-D20-C20-L130-Z03	20	3	20	130	40		197,00 €
	AHFM-L003-D20-C20-L130-Z03-H	20	3	20	130	40	LOGU 0303..	197,00 €
	AHFM-L003-D20-C20-L160-Z03	20	3	20	160	80	FOR KYCR	197,00 €
	AHFM-L003-D20-C20-L160-Z03-H	20	3	20	160	100	INSERT.	197,00 €
	AHFM-L003-D21-C20-L150-Z03-H	21	3	20	150	30		197,00 €
	AHFM-L003-D21-C20-L200-Z03	21	3	20	200	30		238,00 €
	AHFM-L003-D21-C20-L200-Z03-H	21	3	20	200	30		285,00 €
	AHFM-L003-D25-C25-L140-Z04	25	4	25	140	50		218,00 €
	AHFM-L003-D25-C25-L140-Z04-F	25	4	25	140	50		327,00 €
	AHFM-L003-D25-C25-L180-Z04	25	4	25	180	100		282,00 €
	AHFM-L003-D26-C25-L250-Z04	26	4	25	250	40		387,00 €
AHFM-L003-D32-C32-L200-Z05	32	5	32	200	120		355,00 €	
AHFM-L003-D33-C32-L250-Z05	33	5	32	250	40		438,00 €	
	AHFM-LP0102-D10-C09-L120-Z02	10	2	9	120	20	LPGT 0102..	140,00 €
	AHFM-LP0102-D10-C10-L120-Z02	10	2	10	120	20	FOR KYCR	140,00 €
	AHFM-LP0102-D12-C11-L120-Z02	12	2	11	120	20	INSERT.	140,00 €
	AHFM-LP0102-D12-C12-L120-Z02	12	2	12	120	20		140,00 €

S - SYSTEM HIGHFEED END MILLS / S - SYSTEM HOCHGESCHWINDIGKEITS

	CODE / TYP	TOOL DIMENSIONS (mm) <small>MAß</small>					CUTTING INSERT WENDE PLATTE	PRICE / PREIS
		DCX	ZEFP	DCON	LF	LH		
	AHFM-SD06T2-D16-C16-L100-Z02-H	16	2	16	100	50		117,00 €
	AHFM-SD06T2-D16-C16-L150-Z02-H	16	2	16	150	50		141,00 €
	AHFM-SD06T2-D16-C16-L200-Z02	16	2	16	200	100	SD.. 06T2..	175,00 €
	AHFM-SD06T2-D17-C16-L150-Z02-H	17	2	16	150	50	FOR ZCC	141,00 €
	AHFM-SD06T2-D20-C20-L150-Z03-H	20	3	20	150	50	INSERT.	162,00 €
	AHFM-SD06T2-D20-C20-L200-Z03	20	3	20	200	100		204,00 €
	AHFM-SD06T2-D21-C20-L150-Z03-H	21	3	20	150	50		162,00 €
	AHFM-SD06T2-D25-C25-L150-Z04-H	25	4	25	150	60		182,00 €
	AHFM-SD06T2-D26-C25-L150-Z04-H	26	4	25	150	60		182,00 €
	AHFMC-SD09T3-D22-W20-L150-Z02	22	2	20	150	30		138,00 €
	AHFMC-SD09T3-D25-C25-L150-Z02	25	2	25	150	94		138,00 €
	AHFMC-SD09T3-D25-W25-L150-Z02	25	2	25	150	94	SD.. 09T3..	138,00 €
	AHFMC-SD09T3-D28-C25-L150-Z02	28	2	25	150	30	FOR ZCC	141,00 €
	AHFMC-SD09T3-D32-C32-L150-Z03	32	3	32	150	100	INSERT.	158,00 €
	AHFMC-SD09T3-D32-W32-L150-Z03	32	3	32	150	90		158,00 €
	AHFM-SD09T3-D25-C25-L150-Z03	25	3	25	150	60		151,00 €
AHFM-SD09T3-D32-C32-L150-Z04	32	4	25	150	60		172,00 €	
	AHFM-SO0803-D20-W20-L150-Z02	20	2	20	150	50	SOMW 080315	131,00 €
	AHFM-SO0803-D25-W25-L150-Z03	25	3	25	150	50	FOR KPTK	143,00 €
	AHFM-SO0803-D32-W32-L150-Z04	32	4	32	150	50	INSERT.	156,00 €
	AHFM-SP1004-D25-C25-L150-Z02	25	2	25	150	50	SPNW 1004..	159,00 €
	AHFM-SP1004-D32-C32-L150-Z03	32	3	32	150	50	FOR DJT	183,00 €
							INSERT.	
	AHFM-Y00602-D10-C09-L120-Z02-F	10	2	9	120	15		200,00 €
	AHFM-Y00602-D10-C10-L080-Z02-F	10	2	10	80	20		200,00 €
	AHFM-Y00602-D10-C10-L120-Z02-F	10	2	10	120	60		200,00 €
	AHFM-Y00602-D10-C10-L120-Z02-H-F	10	2	10	120	60		200,00 €
	AHFM-Y00602-D10-C10-L120-Z02-H	10	2	10	120	60		134,00 €
	AHFM-Y00602-D12-C11-L120-Z02-F	12	2	11	120	15		200,00 €
	AHFM-Y00602-D12-C11-L120-Z02-H-F	12	2	11	120	15	YOHW 0602..	200,00 €
	AHFM-Y00602-D12-C11-L120-Z02-H	12	2	11	120	15	FOR DJT	134,00 €
	AHFM-Y00602-D12-C11-L120-Z03-F	12	3	11	120	15	INSERT.	226,00 €
	AHFM-Y00602-D12-C12-L080-Z02-F	12	2	12	80	20		200,00 €
	AHFM-Y00602-D12-C12-L080-Z03-F	12	3	12	80	20		226,00 €
	AHFM-Y00602-D12-C12-L120-Z02-F	12	2	12	120	60		200,00 €
	AHFM-Y00602-D12-C12-L120-Z02-H	12	2	12	120	60		134,00 €
	AHFM-Y00602-D12-C12-L120-Z03-F	12	3	12	120	60		226,00 €
	AHFM-Y00602-D12-C12-L120-Z03-H	12	3	12	120	60		152,00 €

S - SYSTEM HIGHFEED END MILLS / S - SYSTEM HOCHGESCHWINDIGKEITS

	CODE / TYP	TOOL DIMENSIONS (mm) <small>MAG</small>					CUTTING INSERT WENDE PLATTE	PRICE / PREIS
		DCX	ZEFP	DCON	LF	LH		
	AHFM-YP1003-D16-C15-L150-Z02-F	16	2	15	150	20		167,00 €
	AHFM-YP1003-D16-C15-L200-Z02-F	16	2	15	200	20		248,00 €
	AHFM-YP1003-D16-C16-L150-Z02-F	16	2	16	150	50		167,00 €
	AHFM-YP1003-D17-C16-L150-Z02-F	17	2	16	150	20		167,00 €
	AHFM-YP1003-D17-C16-L200-Z02-F	17	2	16	200	20		248,00 €
	AHFM-YP1003-D20-C18-L150-Z03-F	20	3	18	150	25		200,00 €
	AHFM-YP1003-D20-C18-L200-Z03-F	20	3	18	200	25		301,00 €
	AHFM-YP1003-D20-C20-L150-Z03-F	20	3	20	150	50		200,00 €
	AHFM-YP1003-D21-C20-L150-Z03-F	21	3	20	150	20	YPHW 1003..	200,00 €
	AHFM-YP1003-D21-C20-L150-Z03-H	21	3	20	150	20	FOR DJT	160,00 €
	AHFM-YP1003-D21-C20-L150-Z04-F	21	4	20	150	20	INSERT.	236,00 €
	AHFM-YP1003-D21-C20-L200-Z03	21	3	20	200	20		301,00 €
	AHFM-YP1003-D21-C20-L200-Z03-F	21	3	20	200	20		301,00 €
	AHFM-YP1003-D25-C20-L150-Z04-F	25	4	20	150	25		214,00 €
	AHFM-YP1003-D25-C20-L200-Z04-F	25	4	20	200	25		321,00 €
	AHFM-YP1003-D25-C25-L150-Z04-F	25	4	25	150	50		214,00 €
	<small>NEW</small> AHFM-YP1003-D25-C25-L150-Z04-H	25	4	25	150	50		167,00 €
	AHFM-YP1003-D26-C25-L150-Z04	26	4	25	150	30		143,00 €
	AHFM-YP1003-D26-C25-L150-Z04-F	26	4	25	150	30		214,00 €
	AHFM-YP1003-D26-C25-L200-Z03-F	26	3	25	200	30		301,00 €
AHFM-YP1003-D26-C25-L200-Z04-F	26	4	25	200	30		321,00 €	
<small>NEW</small> AHFM-YP1003-D26-C25-L250-Z04-F	26	4	25	250	30		385,00 €	
<small>NEW</small> AHFM-YP1003-D33-C32-L200-Z04-F	33	4	32	200	30		347,00 €	
<small>NEW</small> AHFM-YP1003-D33-C32-L250-Z04-F	33	4	32	250	30		435,00 €	
<small>NEW</small> AHFM-YP1003-D33-C32-L300-Z04-F	33	4	32	300	30		521,00 €	
	AHFM-WD0503D-D20-C20-L150-Z02	20	2	20	150	50	WDMT 0503..	112,00 €
	AHFM-WD0503D-D21-C20-L150-Z02	21	2	20	150	30	FOR DJT INSERT.	138,00 €
	AHFMC-WD06T3D-D26-C25-L200-Z02	26	2	25	200	30	WDHW 06T3..	182,00 €
	AHFMC-WD06T3D-D33-C32-L200-Z03	33	3	32	200	32	FOR DJT INSERT.	210,00 €
	AHFM-WD0603-D16-C16-L150-Z02	16	2	16	150	70	WDMT 0603..	237,00 €
	AHFM-WD0603-D20-C20-L150-Z03	20	3	20	150	70	FOR SMTM INSERT.	251,00 €
	AHFMC-WD0804-D25-C25-L150-Z02	25	2	25	150	70	WDMT 0804..	181,00 €
	AHFMC-WD0804-D32-C32-L150-Z03	32	3	32	150	70	FOR SMTM INSERT.	214,00 €
	AHFMC-WD1205-D32-C32-L150-Z02	32	2	32	150	70	WDMT 1205..	182,00 €
	AHFM-W004T2D-D16-C16-L150-Z02	16	2	16	150	20	WOMW 04T2..	115,00 €
	AHFM-W004T2D-D17-C16-L150-Z02	17	2	16	150	20	FOR DJT INSERT.	120,00 €

S - SYSTEM HIGHFEED END MILLS / S - SYSTEM HOCHGESCHWINDIGKEITS



	CODE / TYP	TOOL DIMENSIONS (mm) <small>MAß</small>					CUTTING INSERT WENDE PLATTE	PRICE / PREIS
		DCX	ZEFP	DCON	LF	LH		
	AHFM-WN0603-D16-C16-L110-Z02-H	16	2	16	110	30		123,00 €
	AHFM-WN0603-D16-C16-L150-Z02-H	16	2	16	150	70	WNMX 0603..	153,00 €
	AHFM-WN0603-D17-C16-L150-Z02-H	17	2	16	150	20	FOR KRLY	153,00 €
	AHFM-WN0603-D20-C20-L150-Z02-H	20	2	20	150	70	INSERT.	158,00 €
	AHFM-WN0603-D20-C20-L200-Z02-H	20	2	20	200	100		222,00 €
	AHFM-WN0603-D21-C20-L150-Z02-H	21	2	20	150	20		158,00 €
	AHFM-WN09T3-D25-W25-L120-Z02-H	25	2	25	120	40		162,00 €
	AHFML-WN09T3-D25-W25-L120-Z02-H	25	2	25	120	40		162,00 €
	AHFM-WN09T3-D25-C25-L200-Z02	25	2	25	200	120	WNMX 09T3..	237,00 €
	AHFM-WN09T3-D30-W25-L120-Z03-H	30	3	25	120	30	FOR KRLY	183,00 €
	AHFM-WN09T3-D32-W32-L120-Z03-H	32	3	32	120	30	INSERT.	183,00 €
	AHFM-WN09T3-D32-W32-L200-Z03-H	32	3	32	200	100		304,00 €
	AHFM-WN09T3-D35-W32-L200-Z04-H	35	4	32	200	50		334,00 €
	AHFM-WN09T3-D40-W32-L120-Z04-H	40	4	32	120	30		204,00 €
	AHFM-WN09T3-D40-C32-L200-Z04	40	4	32	200	30		269,00 €
	AHFM-WN1305-D32-C32-L150-Z02-H	32	2	32	150	70	WNMX 1305..	183,00 €
	AHFM-WN1305-D32-C32-L200-Z02-H	32	2	32	200	120	FOR KRLY	304,00 €
	AHFM-WN1305-D40-C32-L200-Z03-H	40	3	32	200	30	INSERT.	367,00 €

Cutting Calculation : P 166 / Schnittdatenberechnung : S 166

Ordering Example/Beispiel Bestellformular: 1pcs. AHFM-WN0603-D16-C16-L110-Z02-H

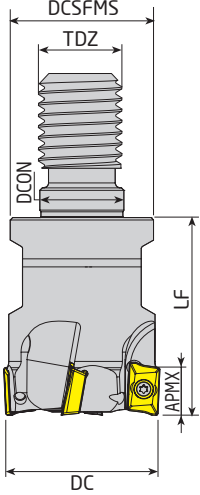

MODULAR END MILLS (SCREW TYPE TOOLS) / EINSCHRAUBFRÄSER

	CODE / TYP	TOOL DIMENSIONS (mm) <small>MAB</small>						CUTTING INSERT WENDE PLATTE	PRICE / PREIS
		DC	ZEPF	DCSFMS	TDZ	LF	DCON		
  90°	AEM90-AP0903-D20-M12-L35-Z03	20	3	18	M12	35	12.5	APMT 0903..	126,00 €
	AEM90-AP0903-D25-M12-L35-Z03	25	3	21	M12	35	12.5	FOR KRLY INSERT.	131,00 €
	AEM90-AP10-D16-M08-L30-Z02-H	16	2	14.75	M08	30	8.5		107,00 €
	AEM90-AP10-D20-M10-L30-Z03-H	20	3	18	M10	30	10.5		126,00 €
	AEM90-AP10-D25-M12-L35-Z03-H	25	3	21	M12	35	12.5	AP.. 1003..	131,00 €
	AEM90-AP10-D32-M16-L35-Z04-H	32	4	29	M16	35	17	FOR ISO	152,00 €
	AEM90-AP10-D32-M16-L40-Z04-H	32	4	29	M16	40	17	INSERT.	152,00 €
	AEM90-AP10-D40-M16-L43-Z05-H	40	5	29	M16	43	17		175,00 €
	AEM90-AP10-D42-M16-L43-Z05-H	42	5	29	M16	43	17		175,00 €
	AEM90-AP10D-D16-M08-L30-Z02-H	16	2	14.75	M08	30	8.5		107,00 €
	AEM90-AP10D-D20-M10-L30-Z03-H	20	3	18	M10	30	10.5	AP.. 1003..	126,00 €
	AEM90-AP10D-D25-M12-L35-Z03-H	25	3	21	M12	35	12.5	FOR DJT INSERT.	131,00 €
	AEM90-AP11-D16-M08-L30-Z02-H	16	2	14.75	M08	30	8.5	AP.. 11T3..	107,00 €
	AEM90-AP11-D20-M10-L30-Z03-H	20	3	18	M10	30	10.5		126,00 €
	AEM90-AP11-D25-M12-L35-Z03-H	25	3	21	M12	35	12.5	FOR ZCC	131,00 €
	AEM90-AP11-D32-M16-L35-Z04-H	32	4	29	M16	35	17	INSERT.	152,00 €
	AEM90-AP11-D40-M16-L43-Z05-H	40	5	29	M16	43	17		173,00 €
	AEM90-AP16-D25-M12-L43-Z02-H	42	4	29	M16	43	17		131,00 €
	AEM90-AP16-D32-M16-L43-Z03-H	25	2	21	M12	43	12.5	AP.. 1604..	152,00 €
	AEM90-AP16-D40-M16-L43-Z04-H	32	3	29	M16	43	17		175,00 €
AEM90-AP16-D42-M16-L43-Z04	40	4	29	M16	43	17	FOR ISO	175,00 €	
AEM90-AP16-D42-M16-L43-Z04-H	42	4	29	M16	43	17	INSERT.	175,00 €	
AEM90-AP16DJ-D25-M12-L43-Z02-H	25	2	21	M12	43	12.5	AP.. 1604..	131,00 €	
AEM90-AP16DJ-D32-M16-L43-Z03-H	32	3	29	M16	43	17	FOR DJT	152,00 €	
AEM90-AP16DJ-D40-M16-L43-Z04-H	40	4	29	M16	43	17	INSERT.	175,00 €	
AEM90-AP16L-D25-M12-L43-Z02-H	25	2	21	M12	43	12.5	AP.. 1604..	131,00 €	
AEM90-AP16L-D32-M16-L43-Z03-H	32	3	29	M16	43	17	FOR LMNA	152,00 €	
AEM90-AP16L-D40-M16-L43-Z04-H	40	4	29	M16	43	17	INSERT.	175,00 €	
 90°	AEM90-A01236-D16-M08-L30-Z02	16	2	14.8	M08	30	8.5	AO.. 1236..	153,00 €
	AEM90-A01236-D20-M10-L35-Z03	20	3	18	M10	35	10.5	FOR MTSBH	180,00 €
								INSERT.	
 90°	AEM90-AD1505D-D25-M12-L43-Z02-H	25	2	21	M12	43	12.5	ADKT 150508	155,00 €
	AEM90-AD1505D-D32-M16-L43-Z03-H	32	3	29	M16	43	17	FOR DJT	169,00 €
								INSERT.	





MODULAR END MILLS (SCREW TYPE TOOLS) / EINSCHRAUBFRÄSER

	CODE / TYP	TOOL DIMENSIONS (mm) <small>MAß</small>						CUTTING INSERT WENDE PLATTE	PRICE / PREIS
		DC	ZEFP	DCSFMS	TDZ	LF	DCON		
 90°	AEM90-AX1235-D16-M08-L30-Z02-H	16	2	14.75	M08	30	8.5	AX.T 1235..	139,00 €
	AEM90-AX1235-D20-M10-L30-Z03-H	20	3	18	M10	30	10.5	FOR SMTM	158,00 €
	AEM90-AX1235-D25-M12-L35-Z04-H	25	4	21	M12	35	12.5	INSERT.	185,00 €
	AEM90-AX1705-D25-M12-L43-Z02-H	25	2	21	M12	43	12.5	AX.T 1705..	167,00 €
	AEM90-AX1705-D32-M16-L43-Z02-H	32	2	29	M16	43	17	FOR SMTM	181,00 €
							INSERT.		
 90°	AEM90-BD11T3-D16-M08-L25-Z02-H	16	2	14.75	M08	25	8.5	BDMT 11T3..	127,00 €
	AEM90-BD11T3-D25-M12-L35-Z04-H	25	4	21	M12	35	12.5	FOR KYCR	148,00 €
	AEM90-BD11T3-D32-M16-L40-Z05-H	32	5	29	M16	40	17	INSERT.	173,00 €
 90°	AEM90-DC07-D20-M10-L30-Z02-H	20	2	18	M10	30	10.5	DC.T 0702..	126,00 €
	AEM90-DC07-D25-M12-L35-Z03-H	25	3	21	M12	35	12.5	FOR ISO	143,00 €
	AEM90-DC07-D32-M16-L43-Z04-H	32	4	29	M16	43	17	INSERT.	162,00 €
	AEM90-DC07-D40-M16-L43-Z05-H	40	5	29	M16	43	17		173,00 €
	AEM90-DC11-D32-M16-L43-Z03-H-F	32	3	29	M16	43	17	DC.T 11T3..	262,00 €
	AEM90-DC11-D40-M16-L43-Z03-H-F	40	3	29	M16	43	17	FOR ISO	262,00 €
							INSERT.		
 90°	AEM90-R390.11-D16-M08-L30-Z02-H	16	2	14.75	M08	30	8.5	R390-11T3..	131,00 €
	AEM90-R390.11-D20-M10-L30-Z03-H	20	3	18	M10	30	10.5	FOR SNDVK	152,00 €
	AEM90-R390.11-D25-M12-L35-Z03-H	25	3	21	M12	35	12.5	INSERT.	158,00 €
	AEM90-R390.11-D32-M16-L43-Z04-H	32	4	29	M16	43	17		171,00 €
 90°	AEM90-RT10-D16-M08-L20-Z02-H	16	2	14.75	M08	20	8.5	RT 1003..	129,00 €
	AEM90-RT10-D20-M10-L25-Z03-H	20	3	18	M10	25	10.5	FOR SFTY	146,00 €
	AEM90-RT10-D25-M12-L30-Z04-H	25	4	21	M12	30	12.5	INSERT.	152,00 €
	AEM90-RT10-D32-M16-L43-Z05-H	32	5	29	M16	43	17		170,00 €
	AEM90-RT10-D42-M16-L43-Z06-H	42	6	29	M16	43	17		195,00 €
 90°	NEW AEM90-TNG10-D20-M10-L26-Z02-H	20	2	18	M10	26	10.5	TNGX 1004..	146,00 €
	NEW AEM90-TNG10-D20-M10-L26-Z03-H	20	3	18	M10	26	10.5	FOR PRMT	165,00 €
	AEM90-TNG10-D21-M10-L25-Z03-H	21	3	18	M10	25	10.5	INSERT.	165,00 €
	NEW AEM90-TNG10-D25-M12-L33-Z03-H	25	3	21	M12	33	12.5		175,00 €
	NEW AEM90-TNG10-D25-M12-L33-Z04-H	24	4	21	M12	33	12.5		187,00 €
	AEM90-TNG10-D26-M12-L30-Z04-H	26	4	21	M12	30	12.5		160,00 €
	NEW AEM90-TNG10-D32-M16-L43-Z04-H	32	4	29	M16	43	17		187,00 €
	NEW AEM90-TNG10-D32-M16-L43-Z05-H	32	5	29	M16	43	17		211,00 €
	AEM90-TNG10-D33-M16-L43-Z05-H	33	5	29	M16	43	17		211,00 €
AEM90-TNG10-D35-M16-L43-Z05-H	35	5	29	M16	43	17		223,00 €	

MODULAR END MILLS (SCREW TYPE TOOLS) / EINSCHRAUBFRÄSER



	CODE / TYP	TOOL DIMENSIONS (mm) <small>MAß</small>						CUTTING INSERT <small>WENDE PLATTE</small>	PRICE / PREIS	
		DC	ZEFP	DCSFMS	TDZ	LF	DCON			
 90°	AEM90-WN0604Z-D25-M12-L35-Z02-H	25	2	21	M12	35	12.5	WNHU 0604..	155,00 €	
	AEM90-WN0604Z-D32-M16-L43-Z03-H	32	3	29	M16	43	17	FOR ZCC	170,00 €	
	AEM90-WN0604Z-D40-M16-L43-Z04-H	40	4	29	M16	43	17	INSERT.	194,00 €	
 90°	AEM90-3P1004-D20-M10-L35-Z02	20	2	18	M10	35	10.5	3P.T 1004	152,00 €	
	AEM90-3P1004-D32-M16-L43-Z05-H	32	5	29	M16	43	17	FOR TGTC INSERT.	182,00 €	
 90°	AEM90-XN0403-D32-M16-L43-Z05-H	32	5	29	M16	43	17	XNEX 0403..	211,00 €	
	AEM90-XN0403-D42-M16-L43-Z06-H	42	6	29	M16	43	17	FOR SC INSERT.	233,00 €	
 95°	AEM95-XD0206-D16-M08-L23-Z02-H	16	2	14.75	M08	23	8.5	XDHW 0206..	107,00 €	
	AEM95-XD0206-D16-M08-L23-Z02-H-F	16	2	14.75	M08	23	8.5		FOR DJT	160,00 €
	AEM95-XD0206-D20-M10-L30-Z03-H	20	3	18	M10	30	10.5		INSERT.	126,00 €
	AEM95-XD0206-D20-M10-L30-Z03-H-F	20	3	18	M10	30	10.5		188,00 €	
	AEM95-XD0206-D25-M12-L35-Z03-H	25	3	21	M12	35	12.5		197,00 €	
	AEM95-XD0206-D25-M12-L35-Z03-H-F	25	3	21	M12	35	12.5		197,00 €	
	AEM95C-XD0310-D35-M16-L43-Z03-H	35	3	29	M16	43	17	XDHW 0310..	152,00 €	
	AEM95C-XD0310-D35-M16-L43-Z03-H-F	35	3	29	M16	43	17		FOR DJT	226,00 €
	AEM95C-XD0310-D42-M16-L43-Z04-H	42	4	29	M16	43	17		INSERT.	263,00 €
AEM95C-XD0310-D42-M16-L43-Z04-H-F	42	4	29	M16	43	17		263,00 €		
 -°	AEMR-RC10T3-D25-M12-L35-Z03-H	25	3	21	M12	35	12.5	RC.. 10T3..	157,00 €	
	AEMR-RC10T3-D32-M16-L43-Z04-H	32	4	29	M16	43	17	FOR ZCC	173,00 €	
	AEMR-RC10T3-D40-M16-L43-Z05-H	40	5	29	M16	43	17	INSERT.	193,00 €	
 -°	AEMR-RP08T2M-D20-M10-L30-Z02-H	20	2	18	M10	30	10.5	RPMT 08T2..	144,00 €	
	AEMR-RP10T3M-D25-M12-L35-Z02-H	25	2	21	M12	35	12.5	RPMT 10T3..	151,00 €	
	AEMR-RP10T3M-D32-M16-L43-Z03-H	32	3	29	M16	43	17	FOR MTSBSH INSERT.	169,00 €	
	AEMR-RP1204M-D32-M16-L43-Z03-H	32	3	29	M16	43	17	RPMT 1204..	169,00 €	
	AEMR-RP1204M-D40-M16-L43-Z04-H	40	4	29	M16	43	17	FOR MTSBH INSERT.	193,00 €	
 -°	AEMR-RP10T3-D25-M12-L35-Z02-H	25	2	21	M12	35	12.5	RPNX 10T3..	164,00 €	
	AEMR-RP10T3-D32-M16-L43-Z03-H	32	3	29	M16	43	17	FOR CRTZT	181,00 €	
	AEMR-RP1204-D32-M16-L43-Z03-H	32	3	29	M16	43	17	INSERT.	181,00 €	

MODULAR END MILLS (SCREW TYPE TOOLS) / EINSCHRAUBFRÄSER

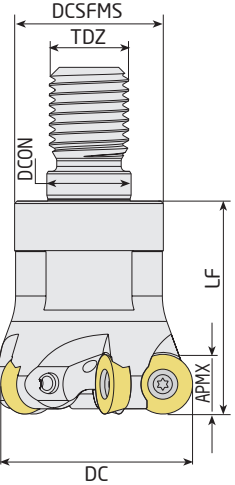



	CODE / TYP	TOOL DIMENSIONS (mm) MAB						CUTTING INSERT WENDE PLATTE	PRICE / PREIS
		DC	ZEFP	DCSFMS	TDZ	LF	DCON		
	NEW AEMR-RY10-D25-M12-L43-Z03-H	25	2	21	M12	43	12.5	RYMX 1004..	186,00 €
	AEMR-RY10-D32-M16-L43-Z04-H	32	4	29	M16	43	17	FOR TGTC INSERT.	198,00 €
	AEMR-RY10-D40-M16-L43-Z05-H	40	5	29	M16	43	17		218,00 €
	AEMR-RY12-D32-M16-L43-Z03-H	32	3	29	M16	43	17	RYMX 1205..	180,00 €
	AEMR-RY12-D40-M16-L43-Z03-H	40	3	29	M16	43	17	FOR TGTC INSERT.	195,00 €
	AEMRC-RD10T3-D20-M10-L30-Z02	20	2	18	M10	30	10.5	RD.. 10T3	114,00 €
	AEMRC-RD10T3-D32-M16-L43-Z03-H	32	3	29	M16	43	17	FOR ISO INSERT.	152,00 €
 	AEMR-RD0702-D15-M08-L23-Z02-H	15	2	13	M08	23	8.5		107,00 €
	AEMR-RD0702-D16-M08-L23-Z02-H	16	2	13	M08	23	8.5		107,00 €
	AEMR-RD0702-D20-M10-L30-Z04-H	20	4	18	M10	30	10.5		131,00 €
	AEMR-RD0702-D25-M12-L35-Z05-H	25	5	21	M12	35	12.5		152,00 €
	AEMR-RD0702-D30-M16-L42-Z05-H	30	5	29	M16	42	17	RD.. 0702	165,00 €
	AEMR-RD0702-D32-M16-L43-Z05-H	32	5	29	M16	43	17	FOR ISO INSERT.	165,00 €
	AEMR-RD0702-D35-M16-L42-Z06-H	35	6	29	M16	42	17		175,00 €
	AEMR-RD0702-D42-M16-L43-Z05-H	42	5	29	M16	43	17		181,00 €
	AEMR-RD0702-D42-M16-L43-Z07-H	42	7	29	M16	43	17		202,00 €
	AEMR-RD08T2-D16-M08-L23-Z02-H	16	2	13	M08	23	8.5		127,00 €
	AEMR-RD08T2-D16-M10-L23-Z02-H	16	2	13	M10	23	8.5	RD.. 08T2	127,00 €
	AEMR-RD08T2-D20-M10-L30-Z03-H	20	3	18	M10	30	10.5	FOR ISO INSERT.	143,00 €
	AEMR-RD08T2-D25-M12-L35-Z04-H	25	4	21	M12	35	12.5		159,00 €
	AEMR-RD0802-D16-M08-L23-Z02-H	16	2	13	M08	23	8.5	RD.. 0802	127,00 €
	AEMR-RD0803-D16-M08-L23-Z02-H	16	2	13	M08	23	8.5	RD.. 0803	127,00 €
	AEMR-RD0803-D20-M10-L30-Z03-H	20	3	18	M10	30	10.5	FOR ISO INSERT.	143,00 €
	AEMR-RD0803-D25-M12-L35-Z04-H	25	4	21	M12	35	12.5		159,00 €
	AEMR-RD1003-D20-M10-L30-Z02-H	20	2	18	M10	30	10.5		114,00 €
	AEMR-RD1003-D25-M12-L35-Z02-H	25	2	21	M12	35	12.5		126,00 €
	AEMR-RD1003-D25-M12-L35-Z03-H	25	3	21	M12	35	12.5	RD.. 1003	131,00 €
	AEMR-RD1003-D30-M16-L43-Z04-H	30	4	29	M16	43	17		152,00 €
	AEMR-RD1003-D32-M16-L43-Z04-H	32	4	29	M16	43	17	FOR ISO INSERT.	152,00 €
	AEMR-RD1003-D35-M16-L43-Z04-H	35	4	29	M16	43	17		157,00 €
	AEMR-RD1003-D40-M16-L43-Z05-H	40	5	29	M16	43	17		175,00 €
	AEMR-RD1003-D42-M16-L43-Z05-H	42	5	29	M16	43	17		175,00 €
	AEMR-RD1004-D25-M12-L35-Z03-H	25	3	21	M12	35	12.5	RD.. 1004	131,00 €
	AEMR-RD1004-D32-M16-L43-Z04-H	32	4	29	M16	43	17	FOR ISO INSERT	152,00 €
	AEMR-RD10T3-D25-M12-L35-Z03-H	25	3	21	M12	35	12.5		131,00 €
AEMR-RD10T3-D32-M16-L45-Z04-H	32	4	29	M16	45	17	RD.. 10T3	152,00 €	
AEMR-RD10T3-D35-M16-L43-Z04-H	35	4	29	M16	43	17	FOR ISO INSERT	157,00 €	
AEMR-RD10T3-D42-M16-L43-Z05-H	42	5	29	M16	43	17		175,00 €	
AEMR-RD12T3-D24-M12-L35-Z02-H	24	2	21	M12	35	12.5		126,00 €	
AEMR-RD12T3-D25-M12-L35-Z02-H	25	2	21	M12	35	12.5	RD.. 12T3	126,00 €	
AEMR-RD12T3-D32-M16-L43-Z03-H	32	3	29	M16	43	17	FOR ISO INSERT.	152,00 €	
AEMR-RD12T3-D35-M16-L43-Z03-H	35	3	29	M16	43	17		157,00 €	
AEMR-RD12T3-D35-M16-L43-Z04-H	35	4	29	M16	43	17		175,00 €	
AEMR-RD12T3-D40-M16-L43-Z04-H	40	4	29	M16	43	17		175,00 €	
AEMR-RD12T3-D42-M16-L43-Z05-H	42	5	29	M16	43	17		195,00 €	
AEMR-RD1204-D25-M12-L35-Z02-H	25	2	21	M12	35	12.5		126,00 €	
AEMR-RD1204-D32-M16-L43-Z03-H	32	3	29	M16	43	17	RD.. 1204	152,00 €	
AEMR-RD1204-D40-M16-L43-Z04-H	40	4	29	M16	43	17	FOR ISO INSERT	175,00 €	
AEMR-RD1204-D42-M16-L43-Z04-H	42	4	29	M16	43	17		175,00 €	
AEMR-RD1604-D32-M16-L43-Z02-H	32	2	29	M16	43	17		170,00 €	
AEMR-RD1604-D40-M16-L43-Z02-H	40	2	29	M16	43	17	RD.. 1604	175,00 €	
AEMR-RD1604-D42-M16-L43-Z03-H	42	3	29	M16	43	17	FOR ISO INSERT	195,00 €	



MODULAR END MILLS (SCREW TYPE TOOLS) / EINSCHRAUBFRÄSER

	CODE / TYP	TOOL DIMENSIONS (mm) <small>MAß</small>						CUTTING INSERT WENDE PLATTE	PRICE / PREIS
		DC	ZEFP	DCSFM5	TDZ	LF	DCON		
	AEMR-RP10T3A-D32-M16-L43-Z04-H	32	4	29	M16	43	17	RPMW 10T3..	173,00 €
	AEMR-RP10T3A-D42-M16-L43-Z05-H	42	5	29	M16	43	17	FOR ACHTK INSERT.	193,00 €
	AEMR-RP10T3K-D32-M16-L43-Z04-H	32	4	29	M16	43	17	RPMT 10T3..	173,00 €
	AEMR-RP10T3K-D42-M16-L43-Z05-H	43	5	29	M16	43	17	FOR KYCR INSERT.	193,00 €
	AEMR-QP10T3-D25-M12-L35-Z02-H	25	2	21	M12	35	12.5	QP.. 10T3..	181,00 €
	AEMR-QP10T3-D32-M16-L43-Z03-H	32	3	29	M16	43	17	FOR SMTM INSERT.	199,00 €

S - SYSTEM MODULAR (SCREW TYPE) HIGHFEED END MILLS / SYSTEM HOCHGESCHWINDIGKEITS - EINSCHRAUBFRÄSER

	CODE / TYP	TOOL DIMENSIONS (mm) <small>MAß</small>						CUTTING INSERT WENDE PLATTE	PRICE / PREIS
		DC	ZEFP	DCSFM5	TDZ	LF	DCON		
	AHFM-BL0603-D20-M10-L30-Z03-H	20	3	18	M10	30	10.5	BLMP 0603	148,00 €
	AHFM-BL0603-D25-M12-L35-Z04-H	25	4	21	M12	35	12.5		171,00 €
	AHFM-BL0603-D32-M16-L40-Z05-H	32	5	29	M16	40	17		178,00 €
	AHFM-BL0904-D32-M16-L40-Z04-H	32	4	29	M16	40	17	BLMP 0904	178,00 €
	AHFM-BL0904-D32-M16-L43-Z04-H	32	4	29	M16	43	17	FOR TGTC INSERT.	178,00 €
	AHFM-BL0904-D42-M16-L43-Z05-H	42	5	29	M16	43	17		193,00 €
	AHFM-ED0702-D12-M06-L20-Z03	12	3	10	M06	20	6.5	EDMT 0702	148,00 €
	AHFM-ED0702-D16-M08-L25-Z04-H	16	4	14.75	M08	25	8.5	JDMT 070204	171,00 €
	AHFM-ED0702-D20-M10-L30-Z05-H	20	5	18	M10	30	10.5	FOR HTCH INSERT.	195,00 €
	AHFM-ED0702-D25-M12-L30-Z06-H	25	6	21	M12	30	12.5		223,00 €
	AHFM-ED0702-D32-M16-L30-Z08-H	32	8	29	M16	30	17		269,00 €
	AHFM-EP1003-D16-M08-L23-Z02	16	2	14.75	M08	23	8.5	EP.. 1003..	125,00 €
	AHFM-EP1003-D16-M08-L23-Z02-H	16	2	14.75	M08	23	8.5	ZPMT 1003..	125,00 €
	AHFM-EP1003-D20-M10-L30-Z03	20	3	18	M10	30	10.5	YPHW 1003..	125,00 €
	AHFM-EP1003-D20-M10-L30-Z04-H	20	4	18	M10	30	10.5	FOR DJT INSERT.	157,00 €
	AHFM-EP1003-D25-M12-L35-Z04-H	25	4	21	M12	35	12.5		179,00 €
	AHFM-EP1003-D32-M16-L43-Z05-H	32	5	29	M16	43	17		192,00 €
	AHFM-EP1003-D35-M16-L43-Z05-H	35	5	29	M16	43	17		192,00 €
	AHFM-EP1003-D42-M16-L43-Z06-H	42	6	29	M16	43	17		195,00 €
	AHFM-EN1004-D16-M08-L23-Z02-H	16	2	14.75	M8	23	8.5		138,00 €
	AHFM-EN1004-D20-M10-L30-Z03-H	20	3	18	M10	30	10.5		157,00 €
	AHFM-EN1004-D25-M12-L35-Z03-H	25	3	21	M12	35	12.5	ENMU 1004..	165,00 €
	AHFM-EN1004-D25-M12-L35-Z04-H	25	4	21	M12	35	12.5	FOR DJT INSERT.	181,00 €
	AHFM-EN1004-D32-M16-L43-Z05-H	32	5	29	M16	43	17		197,00 €
	AHFM-EN1004-D35-M16-L43-Z05-H	35	5	29	M16	43	17		197,00 €
	AHFM-EN1004-D40-M16-L43-Z05-H	40	5	29	M16	43	17		197,00 €
	AHFM-EN1004-D42-M16-L43-Z05-H	42	5	29	M16	43	17		197,00 €
	AHFM-LN0303-D25-M12-L35-Z04-H	25	4	21	M12	35	12.5	LNMU 0303..	213,00 €
	AHFM-LN0303-D32-M16-L43-Z05-H	32	5	29	M16	43	17	FOR TNGLY INSERT.	250,00 €
	AHFM-LN0303-D42-M16-L43-Z06-H	42	6	29	M16	43	17		282,00 €

S - SYSTEM MODULAR (SCREW TYPE) HIGHFEED END MILLS / SYSTEM HOCHGESCHWINDIGKEITS - EINSCHRAUBFRÄSER

	CODE / TYP	TOOL DIMENSIONS (mm) MAß						CUTTING INSERT WENDE PLATTE	PRICE / PREIS
		DC	ZEFP	DCSPMS	TDZ	LF	DCON		
	AHFM-L003-D20-M10-L30-Z04-H-F	20	4	18	M10	30	10.5	LOGU 0303.. FOR KYCR INSERT.	290,00 €
	AHFM-L003-D25-M12-L35-Z04-H-F	25	4	21	M12	35	12.5		290,00 €
	AHFM-L003-D25-M12-L35-Z04-H	25	4	21	M12	35	12.5		194,00 €
	AHFM-L003-D32-M16-L40-Z05-H-F	32	5	29	M16	40	17		346,00 €
	AHFM-L003-D32-M16-L40-Z05-H	32	5	29	M16	40	17		229,00 €
	AHFM-L003-D32-M16-L40-Z06-H-F	32	6	29	M16	40	17		374,00 €
	AHFM-L003-D32-M16-L40-Z06-H	32	6	29	M16	40	17		250,00 €
	AHFM-L003-D35-M16-L40-Z05-H	35	5	29	M16	40	17		229,00 €
	AHFM-L003-D35-M16-L40-Z06-H	35	6	29	M16	40	17		250,00 €
	AHFM-L003-D42-M16-L40-Z05-H	42	5	29	M16	40	17		286,00 €
AHFM-L003-D42-M16-L40-Z06-H	42	6	29	M16	40	17	318,00 €		
	AHFM-JD1003-D16-M08-L30-Z02-H	16	2	14.75	M8	30	8.5	JDMT 1003.. FOR HTCH INSERT.	175,00 €
	AHFM-JD1003-D20-M10-L30-Z03-H	20	3	18	M10	30	10.5		199,00 €
	AHFM-SD1205-D32-M16-L40-Z03-H	32	3	29	M16	40	17	SD.. 1205.. FOR HTCH INSERT.	213,00 €
	AHFM-SD1205-D35-M16-L40-Z03-H	35	3	29	M16	40	17		213,00 €
	AHFM-SD1205-D40-M16-L43-Z03-H	40	3	29	M16	43	17		222,00 €
	AHFM-SD1205-D42-M16-L43-Z03-H	42	3	29	M16	43	17		222,00 €
	AHFMC-JD1204-D32-M16-L43-Z02-H	32	2	29	M16	43	17	JDMW 1204.. FOR MTSBH INSERT.	185,00 €
	AHFMC-JD1204-D42-M16-L43-Z03-H	42	3	29	M16	43	17		233,00 €
	AHFM-SP0735-D16-M08-L23-Z02-H	16	2	14.75	M08	23	8.5	SPMX 073505 FOR MTSBH INSERT.	143,00 €
	AHFM-SP0735-D20-M10-L30-Z03-H	20	3	18	M10	30	10.5		160,00 €
	AHFM-SP0735-D25-M12-L35-Z04-H	25	4	21	M12	35	12.5		179,00 €
	AHFM-SP0945-D32-M16-L43-Z04-H	32	4	29	M16	43	17	SPMX 094506 FOR MTSBH INSERT.	170,00 €
	AHFM-SP0945-D35-M16-L43-Z04-H	35	4	29	M16	43	17		170,00 €
	AHFM-SP0945-D42-M16-L43-Z05-H	42	5	29	M16	43	17		192,00 €
	AHFM-SD06T2-D16-M08-L23-Z02-H	16	2	14.75	M08	23	8.5	SD.. 06T2.. FOR ZCC INSERT.	157,00 €
	AHFM-SD06T2-D20-M10-L30-Z03-H	20	3	18	M10	30	10.5		180,00 €
	AHFM-SD06T2-D25-M12-L35-Z04-H	25	4	21	M12	35	12.5		208,00 €
	AHFMC-SD09T3-D25-M12-L30-Z02-H	25	2	22	M12	30	12.5	SD.. 09T3.. FOR ZCC INSERT.	168,00 €
	AHFMC-SD09T3-D32-M16-L43-Z03-H	32	3	29	M16	43	17		213,00 €
	AHFMC-SD09T3-D35-M16-L43-Z03-H	35	3	29	M16	43	17		213,00 €
	AHFMC-SD09T3-D40-M16-L43-Z04-H	40	4	29	M16	43	17		232,00 €
	AHFMC-SD1204-D32-M16-L43-Z02-H	32	2	29	M16	43	17	SD.. 1204.. FOR ZCC INSERT.	178,00 €
	AHFMC-SD1204-D40-M16-L43-Z03-H	40	3	29	M16	43	17		205,00 €
	AHFM-S00803-D20-M10-L30-Z02-H	20	2	18	M10	30	10.5	SOMW 080315 FOR KPTK INSERT.	143,00 €
	AHFM-S00803-D25-M12-L35-Z03-H	25	3	22	M12	35	12.5		162,00 €
	AHFM-S00803-D32-M16-L43-Z03-H	32	3	29	M16	43	17		162,00 €
	AHFM-S00803-D32-M16-L43-Z04-H	32	4	29	M16	43	17		173,00 €
	AHFM-S00803-D40-M16-L43-Z04-H	40	4	29	M16	43	17		173,00 €
	AHFM-S01004-D32-M16-L40-Z03-H	32	3	29	M16	40	17	SOMT 1004.. FOR KYCR INSERT.	213,00 €
	AHFM-S01004-D40-M16-L40-Z04-H	40	4	29	M16	40	17		232,00 €
	AHFM-S01004-D42-M16-L40-Z04-H	42	4	29	M16	40	17		232,00 €

S - SYSTEM MODULAR (SCREW TYPE) HIGHFEED END MILLS / SYSTEM HOCHGESCHWINDIGKEITS - EINSCHRAUBFRÄSER

	CODE / TYP	TOOL DIMENSIONS (mm) <small>MAß</small>						CUTTING INSERT WENDE PLATTE	PRICE / PREIS
		DC	ZEFP	DCSFS	TDZ	LF	DCON		
	AHFM-S00803P-D32-M16-L35-Z04-H	32	4	29	M16	35	17	SOEW 0803	186,00 €
	AHFM-S00803P-D42-M16-L35-Z05-H	42	5	29	M16	35	17	FOR PLBT INSERT.	198,00 €
	AHFM-YP1003-D16-M08-L23-Z02-F	16	2	14.75	M08	23	8.5		205,00 €
	AHFM-YP1003-D16-M08-L23-Z02-H-F	16	2	14.75	M08	23	8.5		205,00 €
	AHFM-YP1003-D17-M08-L23-Z02-H	17	2	14.75	M08	23	8.5		138,00 €
	AHFM-YP1003-D17-M08-L23-Z02-H-F	17	2	14.75	M08	23	8.5	EP.. 1003..	205,00 €
	AHFM-YP1003-D20-M10-L30-Z03-H	20	3	18	M10	30	10.5	YPHW 1003..	156,00 €
	AHFM-YP1003-D20-M10-L30-Z03-H-F	20	3	18	M10	30	10.5	ZPMT 1003..	234,00 €
	AHFM-YP1003-D20-M10-L30-Z04-H	20	4	18	M10	30	10.5	FOR DJT	175,00 €
	AHFM-YP1003-D20-M10-L30-Z04-F	20	4	18	M10	30	10.5	INSERT.	263,00 €
	AHFM-YP1003-D21-M10-L30-Z03-H	21	3	18	M10	30	10.5		156,00 €
	AHFM-YP1003-D21-M10-L30-Z03-H-F	21	3	18	M10	30	10.5		234,00 €
	AHFM-YP1003-D25-M12-L35-Z04-H	25	4	21	M12	35	12.5		175,00 €
	AHFM-YP1003-D25-M12-L35-Z04-F	25	4	21	M12	35	12.5		263,00 €
	AHFM-YP1003-D25-M12-L35-Z04-H-F	25	4	21	M12	35	12.5		263,00 €
	AHFM-YP1003-D26-M12-L35-Z04-H-F	26	4	21	M12	35	12.5		263,00 €
	AHFM-YP1003-D32-M16-L30-Z05-F	32	5	29	M16	30	17		292,00 €
	AHFM-YP1003-D32-M16-L43-Z05-H-F	32	5	29	M16	43	17		292,00 €
AHFM-YP1003-D40-M16-L43-Z06-H-F	40	6	29	M16	43	17		317,00 €	
AHFM-YP1003-D42-M16-L43-Z06-H-F	42	6	29	M16	43	17		317,00 €	
	AHFM-SP1004-D25-M12-L35-Z02-H	25	4	21	M12	35	12.5	SPNW 1004..	184,00 €
	AHFM-SP1004-D32-M16-L43-Z03-H	32	3	29	M16	43	17	FOR DJT	213,00 €
	AHFM-SP1004-D35-M16-L43-Z03-H	35	3	29	M16	43	17	INSERT.	213,00 €
	AHFM-SP1004-D42-M16-L43-Z04-H	42	4	29	M16	43	17		232,00 €
	AHFMC-WD0804-D25-M12-L35-Z02-H	25	2	21	M12	35	12.5	WDMT 0804..	199,00 €
	AHFMC-WD0804-D32-M16-L35-Z03-H	32	3	29	M16	35	17	FOR SMTM INSERT.	234,00 €
	AHFM-WD0503D-D20-M10-L30-Z02-H	20	2	18	M10	30	10.5	WDMT 0503..	168,00 €
	AHFM-WD0503D-D25-M12-L35-Z03-H	25	3	21	M12	35	12.5	FOR DJT	186,00 €
	AHFM-WD0503D-D32-M16-L43-Z04-H	32	4	29	M16	43	17	INSERT.	213,00 €
	AHFM-WD0503D-D40-M16-L43-Z05-H	40	5	29	M16	43	17		223,00 €
	AHFMC-WD06T3D-D35-M16-L43-Z03-H	35	3	29	M16	43	17	WDHW 06T3..	205,00 €
	AHFMC-WD0805D-D32-M16-L43-Z02-H	32	2	29	M16	43	17	WDHW 0805..	305,00 €
	AHFM-WN09T3-D32-M16-L40-Z03-H	32	3	29	M16	40	17	WNMX 09T3..	162,00 €
	AHFM-WN09T3-D35-M16-L40-Z04-H	35	4	26	M16	40	17	FOR KRLY	182,00 €
	AHFM-WN09T3-D40-M16-L40-Z04-H	40	4	29	M16	40	17	INSERT.	182,00 €



BALL NOSE END MILLS / KUGEL - KOPIERFRÄSER

	CODE / TYP	CUTTING INSERT WENDE PLATTE	PRICE / PREIS
	APMR-BNM12-D12-C12-L130	BNM 120-S	157,00 €
	APMR-BNM16-D16-C16-L175	BNM 160-S	145,00 €
	APMR-BNM16-D16-C16-L200	FOR DJT INSERT.	165,00 €
	APMR-BNM20-D20-C20-L160	BNM 200-S	156,00 €
	APMR-BNM20-D20-C20-L200	FOR DJT	168,00 €
	APMR-BNM20-D20-C20-L250	INSERT	192,00 €
	APMR-BNM25-D25-C25-L160	BNM 250-S	154,00 €
	APMR-BNM25-D25-C25-L200	FOR DJT INSERT.	187,00 €
	APMR-BNM25-D25-C25-L250		233,00 €
	APMR-P3208-D08-C10-L110	P3208 - WLTR	143,00 €
	APMR-P3210-D10-C10-L130	P3210 - WLTR	143,00 €
	APMR-P3210-D10-C12-L130	P3210 - WLTR	143,00 €
	APMR-P3212-D12-C12-L130	P3212 - WLTR	131,00 €
	APMR-P3216-D16-C16-L175	P3216 - WLTR	143,00 €
	APMR-P3220-D20-C20-L200	P3220 - WLTR	155,00 €
	APMR-P3225-D25-C25-L200	P3225 - WLTR	159,00 €
	APMR-P3232-D32-C32-L200	P3232 - WLTR	143,00 €
	FOR WLTR INSERT.		
	APMR-R012-D12-C12-L120	ROHX 1203	127,00 €
	APMR-R012-D12-C16-L160	FOR ZCC INSERT.	131,00 €
	APMR-R016-D16-C16-L160	ROHX 1604	131,00 €
	APMR-R016-D16-C16-L200	FOR ZCC	143,00 €
	APMR-R016-D16-C20-L200	INSERT.	143,00 €
	APMR-R020-D20-C20-L160	ROHX 2005	137,00 €
	APMR-R020-D20-C20-L200	FOR ZCC	153,00 €
	APMR-R020-D20-C25-L220	INSERT.	159,00 €
	APMR-XP16-D16-C16-L150	XPHT 16R0803	131,00 €
	APMR-XP20-D20-C20-L150	XPHT 20R10T3	137,00 €
	APMR-XP25-D25-C25-L150	XPHT 25R1204	145,00 €
		FOR ZCC INSERT.	

BALL NOSE MODULAR (SCREW TYPE) END MILLS / EINSCHRAUB - KUGELFRÄSER

	CODE / TYP	CUTTING INSERT WENDE PLATTE	PRICE / PREIS
	APMR-BNM12-D12-M06-L20	BNM 120-S	143,00 €
	APMR-BNM16-D16-M08-L23	BNM 160-S	166,00 €
	APMR-BNM20-D20-M10-L30	BNM 200-S	172,00 €
		FOR DJT INSERT.	

BALL NOSE MODULAR (SCREW TYPE) END MILLS / EINSCHRAUB - KUGELFRÄSER

	CODE / TYP	CUTTING INSERT WENDE PLATTE		PRICE / PREIS
	APMR-P3216-D16-M08-L25	P3216 - WLTR	151,00 €	
	APMR-P3220-D20-M10-L30	P3220 - WLTR	157,00 €	
	APMR-P3225-D25-M12-L35	P3225 - WLTR	169,00 €	
	APMR-P3232-D32-M16-L43	P3232 - WLTR FOR WLTR INSERT.	174,00 €	
	APMR-XP16-D16-M08-L25	XPHT 16R0803	162,00 €	
	APMR-XP20-D20-M10-L30	XPHT 20R10T3	172,00 €	
	APMR-XP25-D25-M12-L40	XPHT 25R1204 FOR ZCC INSERT.	183,00 €	
	APMR-SWB225-D25-M12-L35	SWB225HM-HS	199,00 €	
	APMR-SWB230-D30-M16-L43	SWB230HM-HS	202,00 €	
	APMR-SWB232-D32-M16-L43	SWB232HM-HS FOR DJT INSERT.	205,00 €	

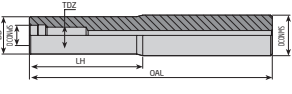

SCREWED TOOL HOLDERS / AUFNAHME FÜR EINSCHRAUBFRÄSER

	CODE / TYP	TOOL DIMENSIONS (mm) MAß						PRICE / PREIS
		DCONMS	TDZ	DCONWS	BD	OAL	LH	
 	AVTT-D13-C16-M08-L100-H	16	8	8.5	13	100	40	120,00 €
	AVTT-D15-C16-M08-L130-H	16	8	8.5	15	130	70	131,00 €
	AVTT-D18-C20-M10-L130-H	20	10	10.5	18	130	70	131,00 €
	AVTT-D18-C20-M10-L160-H	20	10	10.5	18	160	80	144,00 €
	AVTT-D23-C25-M12-L150-H	25	12	12.5	23	150	70	157,00 €
	AVTT-D23-C25-M12-L200-H	25	12	12.5	23	200	100	204,00 €
	AVTT-D23-C25-M12-L250-H	25	12	12.5	23	250	150	245,00 €
	AVTT-D30-C32-M16-L150-H	32	16	17	30	150	70	162,00 €
	AVTT-D30-C32-M16-L200-H	32	16	17	30	200	100	210,00 €
	AVTT-D30-C32-M16-L250-H	32	16	17	30	250	150	252,00 €
AVTT-D30-C32-M16-L300-H	32	16	17	30	300	200	282,00 €	

THREAD MILLING TOOLS / GEWINDEFRÄSWERKZEUGE

	CODE / TYP	TOOL DIMENSIONS (mm) MAß						CUTTING INSERT WENDE PLATTE	PRICE / PREIS
		DC	ZEFP	DCON	LF	LH	APMX		
	ATM-H23-D23-C25-L100-Z02-H	23	2	25	100	30	27	H23	256,00 €
	ATM-H32-D32-C32-L130-Z05-H	32	5	32	130	35	32	H32	299,00 €
								FOR CPT INSERT.	

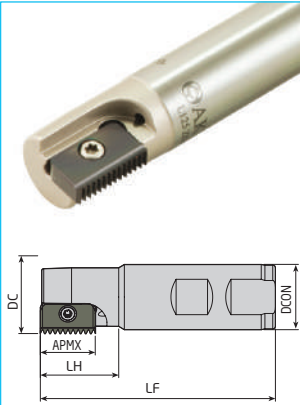

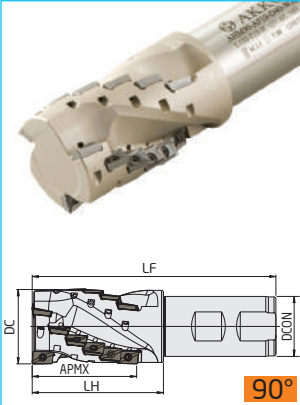
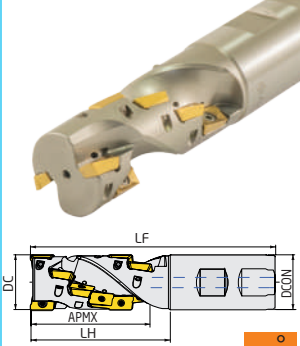

THREAD MILLING TOOLS / GEWINDEFRÄSWERKZEUGE

	CODE / TYP	TOOL DIMENSIONS (mm) <small>MAB</small>						CUTTING INSERT WENDE PLATTE	PRICE / PREIS	
		DC	ZEPF	DCON	LF	LH	APMX			
	ATM-C14-D14-W20-L100-Z01-H	14	1	20	100	25	14	C14	120,00 €	
	ATM-C21-D18-W20-L100-Z01-H	18	1	20	100	30	21		144,00 €	
	ATM-C21-D21-W25-L125-Z01-H	21	1	25	125	40	21		157,00 €	
	ATM-C21-D25-W20-L125-Z01-H	25	1	20	125	30	21	C21	157,00 €	
	ATM-C21-D28-W25-L90-Z01-H	28	1	25	90	30	21	FOR CPT	197,00 €	
	ATM-C21-D38-W32-L90-Z03-H	38	3	32	90	21	31	INSERT.	216,00 €	
	ATM-C21-D38-W32-L120-Z03-H	38	3	32	120	30	21		216,00 €	
	ATM-C21-D43-W32-L90-Z03-H	43	3	32	90	30	21		233,00 €	
	ATM-C30-D29-W25-L150-Z01-H	29	1	25	150	50	30	C30	227,00 €	
								FOR CPT		
								INSERT.		
	ATM-3BEI-D21-W25-L100-Z01-H	21	1	25	190	30	21	3BEI..	157,00 €	
	ATM-3EI-D14-W20-L90-Z01-H	14	1	20	90	22	15.3	3E../3I..	120,00 €	
	ATM-3EI-D20-W25-L120-Z01-H	20	1	25	120	25	15.3	FOR VRGS	157,00 €	
								INSERT.		
	ATM60-TB0601-D13-C10-L150-Z02-H	60	13	10	2.5	150	40	3.3	TBGT 060102	154,00 €
	ATM60-TC0902-D20.5-C16-L150-Z02-H	60	20.5	16	5.2	150	40	4.7	TC.T 090202	154,00 €
	ATM60-TC1102-D26-C20-L150-Z03-H	60	26	20	8.3	150	50	5.4	TC.T 110202	180,00 €
	ATM60-TC16T3-D32-C25-L150-Z02-H	60	32	25	6.4	150	50	8	TC.T 16T304	188,00 €
	ATM60-TC16T3-D40-C32-L250-Z03-H	60	40	32	13.7	250	50	8	FOR ISO INSERT.	269,00 €

HELIX END MILL / WP - IGELEFRÄSER

	CODE / TYP	ZEPF		TOOL DIMENSIONS (mm) <small>MAB</small>				CUTTING INSERT WENDE PLATTE	PRICE / PREIS	
		Total	Effective	DC	DCON	APMX	LH			LF
	AHM90-AP10-D20-W20-L087-Z04	4	2	20	20	28	37	87		316,00 €
	AHM90-AP10-D20-W20-L087-Z0204	4	2	20	20	28	37	87	AP..	316,00 €
	AHM90-AP10-D20-W20-L087-Z0206	6	2	20	20	28	37	87	1003..	350,00 €
	AHM90-AP10-D20-W20-L087-Z0206	6	2	20	20	28	37	87	FOR ISO	350,00 €
	AHM90-AP10-D25-W25-L105-Z0208-H	8	2	25	25	37	47	105	INSERT.	421,00 €
	AHM90-AP10-D32-W32-L115-Z0315-H	15	3	32	32	46	55	115		566,00 €
	AHM90-AP10-D40-W32-L130-Z0318-H	18	3	40	32	55	64	130		642,00 €
	AHM90-AP1204-D32-W32-L140-Z0212-H	12	2	32	32	68	80	140	AP.. 1204..	462,00 €
	AHM90-AP1204-D40-W32-L160-Z0321-H	21	3	40	32	79	100	160	FOR TGTC	748,00 €
									INSERT.	

FACE MILLING TOOLS / PLAN UND ECKMESSERKÖPFE

	CODE / TYP	TOOL DIMENSIONS (mm) <small>MAB</small>					CUTTING INSERT WENDE PLATTE	PRICE / PREIS
		DC	ZEFP	DCON	LF	APMX		
 <p>42°</p>	AFM42C-XD0806-D063-A27-Z04-H	63	4	27	50	12		213,00 €
	AFM42C-XD0806-D080-A27-Z05-H	80	5	27	50	12	XDMW 0806..	256,00 €
	AFM42C-XD0806-D100-A32-Z06-H	100	6	32	63	12	FOR DJT	292,00 €
	AFM42C-XD0806-D125-B40-Z07	125	7	40	63	12	INSERT.	384,00 €
	AFM42C-XD0806-D160-C40-Z08	160	8	40	63	12		469,00 €
	AFM42C-XD0806-D200-C60-Z09	200	9	60	63	12		702,00 €
 <p>43°</p>	AFM43-OD0504-D040-A16-Z04-H	40	4	16	40	3.5		120,00 €
	AFM43-OD0504-D050-A22-Z05-H	50	5	22	40	3.5	OD.. 0504..	143,00 €
	AFM43-OD0504-D063-A22-Z06-H	63	6	22	40	3.5	FOR WLTR	168,00 €
	AFM43-OD0504-D080-A27-Z07-H	80	7	27	50	3.5	INSERT.	192,00 €
	AFM43-OD0504-D100-A32-Z08-H	100	8	32	50	3.5		240,00 €
 <p>43°</p>	AFM43-OD0605-D080-A27-Z06-H	80	6	27	50	4	OD.. 0605..	259,00 €
	AFM43-OD0605-D100-A32-Z07-H	100	7	32	50	4	FOR WLTR-LMNA	290,00 €
	AFM43-OD0605-D125-B40-Z08	125	8	40	63	4	INSERT.	382,00 €
 <p>43°</p>	AFM43-OF05T3-D050-A22-Z05-H	50	5	22	40	3	OF.. 05T3..	162,00 €
	AFM43-OF05T3-D063-A22-Z06-H	63	6	22	40	3	FOR ISO INSERT.	185,00 €
	AFM43-OF05T3-D080-A27-Z07-H	80	7	27	50	3		210,00 €
	AFM43-OF05T3-D125-B40-Z09	125	9	40	63	3		423,00 €
 <p>43°</p>	AFM43-ON0604-D050-A22-Z05-H	50	5	22	40	4		169,00 €
	AFM43-ON0604-D063-A22-Z06-H	63	6	22	40	4	ON.. 0604..	197,00 €
	AFM43-ON0604-D080-A27-Z07-H	80	7	27	50	4	FOR ZCC	228,00 €
	AFM43-ON0604-D100-A32-Z08-H	100	8	32	50	4	INSERT.	287,00 €
	AFM43-ON0604-D125-B40-Z09	125	9	40	63	4		382,00 €
 <p>44°</p>	AFM44-ON0606-D063-A22-Z06-H	63	6	22	40	3.8	ONHX 0606..	197,00 €
	AFM44-ON0606-D080-A27-Z08-H	80	8	27	50	3.8	FOR PLBT	228,00 €
	AFM44-ON0606-D100-A32-Z10-H	100	10	32	50	3.8	INSERT.	287,00 €

FACE MILLING TOOLS / PLAN UND ECKMESSERKÖPFE

	CODE / TYP	TOOL DIMENSIONS (mm) <small>MAG</small>					CUTTING INSERT WENDE PLATTE	PRICE / PREIS
		DC	ZEFP	DCON	LF	APMX		
	AFM45-HN0905-D050-A22-Z05-H	50	5	22	40	4.5		221,00 €
	AFM45-HN0905-D063-A22-Z06-H	63	6	22	40	4.5		247,00 €
	AFM45-HN0905-D080-A27-Z07-H	80	7	27	50	4.5	HN.. 0905..	282,00 €
	AFM45L-HN0905-D100-A32-Z08-H	100	8	32	50	4.5	FOR WDA-KNMTL	310,00 €
	AFM45-HN0905-D125-B40-Z10	125	10	40	63	4.5	INSERT.	358,00 €
	AFM45-HN0905-D160-C40-Z12	160	12	40	63	4.5		441,00 €
	AFM45L-HN0905-D160-C40-Z12	160	12	40	63	4.5		441,00 €
	AFM45-HN0905-D200-C60-Z16	200	16	60	63	4.5		751,00 €
	AFM45L-HN0905-D200-C60-Z16	200	16	60	63	4.5		751,00 €
45°								
	AFM40-NN2007-D080-A27-Z06-H	80	6	27	50	6	NNMU 2007..	232,00 €
	AFM40-NN2007-D100-B32-Z07-H	100	7	32	50	6	FOR MTSBH	256,00 €
	AFM40-NN2007-D125-B40-Z08-H	125	8	40	63	6	INSERT.	333,00 €
	AFM40-NN2007-D160-C40-Z10	160	10	40	63	6		375,00 €
	AFM40-NN2007-D200-C60-Z12	200	12	60	63	6		648,00 €
40°								
	<small>NEW</small> AFM45-NN2007-D063-A22-Z05-H	63	5	22	50	6	NNMU 2007..	197,00 €
	<small>NEW</small> AFM45-NN2007-D080-A27-Z06-H	80	6	27	50	6	FOR MTSBH	251,00 €
	AFM45-NN2007-D100-A32-Z07-H	100	7	32	50	6	INSERT.	256,00 €
	AFM45-NN2007-D125-B40-Z08	125	8	40	63	6		304,00 €
	AFM45-NN2007-D160-C40-Z10	160	10	40	63	6		405,00 €
45°								
	AFM45-SE12-D050-A22-Z04-H	50	4	22	40	6		143,00 €
	AFM45L-SE12-D050-A22-Z04-H	50	4	22	40	6	SE.. 12T3..	143,00 €
	AFM45-SE12-D063-A22-Z05-H	63	5	22	40	6	FOR ZCC	168,00 €
	AFM45L-SE12-D063-A22-Z05-H	63	5	22	40	6	INSERT.	168,00 €
	AFM45-SE12-D080-A27-Z06-H	80	6	27	50	6		192,00 €
	AFM45L-SE12-D080-A27-Z06-H	80	6	27	50	6	R245-12T3..	192,00 €
	AFM45-SE12-D100-A32-Z07-H	100	7	32	50	6	FOR SNDVK	240,00 €
	AFM45-SE12-D125-B40-Z08	125	8	40	63	6	INSERT.	316,00 €
	AFM45-SE12-D160-C40-Z10	160	10	40	63	6		394,00 €
	AFM45L-SE12-D160-C40-Z10	160	10	40	63	6		394,00 €
	AFM45-SE12-D200-C60-Z12	200	12	60	63	6		477,00 €
	AFM45-SE14M4-D063-A22-Z04-H	63	4	22	40	7		180,00 €
	AFM45-SE14M4-D080-A27-Z05-H	80	5	27	50	7	SE.. 14M4..	210,00 €
	AFM45-SE14M4-D100-A32-Z05-H	100	5	32	50	7	FOR KRLY	256,00 €
	AFM45-SE14M4-D125-B40-Z06	125	6	40	63	7	INSERT.	341,00 €
	AFM45-SE14M4-D160-C40-Z07	160	7	40	63	7		417,00 €
45°								







FACE MILLING TOOLS / PLAN UND ECKMESSERKÖPFE

	CODE / TYP	TOOL DIMENSIONS (mm) <small>MAG</small>					CUTTING INSERT WENDE PLATTE	PRICE / PREIS
		DC	ZEFP	DCON	LF	APMX		
 45°	AFM45-SE13-D050-A22-Z04-H	50	4	22	40	6		174,00 €
	AFM45-SE13-D063-A22-Z05-H	63	5	22	40	6		205,00 €
	AFM45-SE13-D080-A27-Z06-H	80	6	27	50	6	SEMT 13T3..	231,00 €
	AFM45S-SE13-D050-A22-Z05-H	50	5	22	40	6	FOR SMTM-DJT	277,00 €
	AFM45S-SE13-D063-A22-Z06-H	63	6	22	40	6	INSERT.	324,00 €
	AFM45S-SE13-D080-A27-Z08-H	80	8	27	50	6		404,00 €
	AFM45S-SE13-D100-A32-Z10-H	100	10	32	50	6		513,00 €
	AFM45S-SE13-D125-B40-Z12	125	12	40	63	6		655,00 €
 45°	AFM45-SA1706-D080-A27-Z06-H	80	6	27	50	8.4	SAKU 1706..	227,00 €
	AFM45-SA1706-D100-A32-Z07-H	100	7	32	50	8.4	FOR CRTZT	256,00 €
	AFM45-SA1706-D125-B40-Z09	125	9	40	63	8.4	INSERT.	358,00 €
 45°	AFM45C-SN12..-D050-A22-Z04-H	50	4	22	42	6		173,00 €
	AFM45CL-SN12..-D050-A22-Z05-H	50	5	22	42	6		192,00 €
	AFM45C-SN12..-D050-A22-Z05-H	50	5	22	42	6		192,00 €
	AFM45C-SN12..-D063-A22-Z06-H	63	6	22	42	6		199,00 €
	AFM45C-SN12..-D063-A22-Z07-H	63	7	22	42	6		218,00 €
	AFM45CL-SN12..-D063-A22-Z07-H	63	7	22	42	6		218,00 €
	AFM45C-SN12..-D080-A27-Z07-H	80	7	27	52	6	SN.. 12...	231,00 €
	AFM45C-SN12..-D080-A27-Z08-H	80	8	27	52	6	FOR WLTR-LMN-	250,00 €
	AFM45CL-SN12..-D080-A27-Z08-H	80	8	27	52	6	ACHTK	250,00 €
	AFM45C-SN12..-D100-A32-Z08-H	100	8	32	52	6	INSERT..	262,00 €
	AFM45C-SN12..-D100-A32-Z10-H	100	10	32	52	6		283,00 €
	AFM45CL-SN12..-D100-A32-Z10-H	100	10	32	52	6		283,00 €
	AFM45C-SN12..-D125-B40-Z11	125	11	40	65	6		394,00 €
	AFM45CL-SN12..-D125-B40-Z11	125	11	40	65	6		394,00 €
	AFM45C-SN12..-D160-C40-Z12	160	12	40	65	6		485,00 €
	AFM45C-SN12..-D200-C60-Z14	200	14	60	65	6		826,00 €
AFM45CL-SN12..-D200-C60-Z14	200	14	60	65	6		826,00 €	
 45°	AFM45-SE13M-D050-A22-Z04-H	50	4	22	40	6	SEMT 13T3..	186,00 €
	AFM45-SE13M-D063-A22-Z05-H	63	5	22	40	6	FOR MTSBH	222,00 €
	AFM45-SE13M-D080-A27-Z06	80	6	27	50	6	INSERT.	216,00 €
	AFM45-SE13M-D100-A32-Z07	100	7	32	50	6		245,00 €
	AFM45-SE13M-D125-B40-Z08	125	8	40	63	6		383,00 €
 45°	AFM45S-SE13M-D050-A22-Z04-H	50	4	22	40	6	SEMT 13T3..	198,00 €
	AFM45S-SE13M-D063-A22-Z05-H	63	5	22	40	6	FOR MTSBH	237,00 €
	AFM45S-SE13M-D080-A27-Z06	80	6	27	50	6	INSERT.	234,00 €
	AFM45S-SE13M-D100-A32-Z07	100	7	32	50	6		266,00 €
	AFM45S-SE13M-D125-B40-Z08	125	8	40	63	6		407,00 €

FACE MILLING TOOLS / PLAN UND ECKMESSERKÖPFE

	CODE / TYP	TOOL DIMENSIONS (mm) <small>MAB</small>					CUTTING INSERT WENDE PLATTE	PRICE / PREIS	
		DC	ZEFP	DCON	LF	APMX			
	AFM45C-SN1206-D050-A22-Z04-H	50	4	22	42	6		156,00 €	
	AFM45CL-SN1206-D050-A22-Z05-H	50	5	22	22	6		173,00 €	
	AFM45C-SN1206-D050-A22-Z05-H	50	5	22	42	6		173,00 €	
	AFM45C-SN1206-D063-A22-Z06-H	63	6	22	42	6		180,00 €	
	AFM45C-SN1206-D063-A22-Z07-H	63	7	22	42	6	SN.. 1206..	197,00 €	
	AFM45CL-SN1206-D063-A22-Z07-H	63	7	22	42	6	FOR	197,00 €	
	AFM45C-SN1206-D080-A27-Z07-H	80	7	27	52	6	KRLY-PLBT-BHLR	210,00 €	
	AFM45C-SN1206-D080-A27-Z08-H	80	8	27	52	6	INSERT.	227,00 €	
	AFM45CL-SN1206-D080-A27-Z08-H	80	8	27	52	6		227,00 €	
	AFM45C-SN1206-D100-A32-Z08-H	100	8	32	52	6		239,00 €	
	AFM45C-SN1206-D100-A32-Z10-H	100	10	32	52	6		256,00 €	
	AFM45CL-SN1206-D100-A32-Z10-H	100	10	32	52	6		256,00 €	
	AFM45C-SN1206-D125-B40-Z11	125	11	40	65	6		358,00 €	
	AFM45CL-SN1206-D125-B40-Z11	125	11	40	65	6		358,00 €	
	AFM45C-SN1206-D160-C40-Z12	160	12	40	65	6		441,00 €	
	NEW AFM45CL-SN1206-D160-C40-Z12	160	12	40	65	6		441,00 €	
	AFM45C-SN1206-D200-C60-Z14	200	14	60	65	6		751,00 €	
	AFM45CL-SN1206-D200-C60-Z14	200	14	60	65	6		751,00 €	
45°									
	AFM45C-SN12Z-D050-A22-Z05-H	50	5	22	42	6		173,00 €	
	AFM45C-SN12Z-D063-A22-Z06-H	63	6	22	42	6	SNEG 1205..	197,00 €	
	AFM45C-SN12Z-D080-A27-Z07-H	80	7	27	52	6	FOR ZCC INSERT.	227,00 €	
	AFM45C-SN12Z-D100-A32-Z09-H	100	9	32	52	6		256,00 €	
	AFM45C-SN12Z-D125-B40-Z11	125	11	40	65	6		358,00 €	
	AFM45C-SN12Z-D160-C40-Z12	160	12	60	65	6		441,00 €	
	AFM45C-SN12Z-D200-C60-Z14	200	14	60	65	6		751,00 €	
45°									
	NEW AFM45-ON0806-D050-A22-Z04-H	50	4	22	40	5.5		173,00 €	
	AFM45-ON0806-D063-A22-Z05-H	63	5	22	40	5.5		197,00 €	
	AFM45-ON0806-D063-A22-Z06-H	63	6	22	40	5.5	ON.. 0806..	225,00 €	
	NEW AFM45-ON0806-D063-A22-Z07-H	63	7	22	40	5.5	FOR ISO	254,00 €	
	AFM45-ON0806-D080-A27-Z06-H	80	6	27	50	5.5	INSERT.	227,00 €	
	AFM45-ON0806-D080-A27-Z08-H	80	8	27	50	5.5		286,00 €	
	AFM45-ON0806-D100-A32-Z07-H	100	7	32	50	5.5		256,00 €	
	NEW AFM45-ON0806-D100-A32-Z10	100	10	32	50	5.5		344,00 €	
	AFM45-ON0806-D100-A32-Z10-H	100	10	32	50	5.5		344,00 €	
	NEW AFM45L-ON0806-D100-A32-Z10-H	100	10	32	50	5.5		344,00 €	
	AFM45-ON0806-D125-B40-Z08	125	8	40	63	5.5		304,00 €	
	NEW AFM45L-ON0806-D125-B40-Z08	125	8	40	63	5.5		304,00 €	
	AFM45-ON0806-D125-B40-Z12	125	12	40	63	5.5		421,00 €	
	AFM45-ON0806-D160-C40-Z10	160	10	40	63	5.5		405,00 €	
	AFM45-ON0806-D160-C40-Z14	160	14	40	63	5.5		517,00 €	
	AFM45-ON0806-D200-C60-Z12	200	12	60	63	5.5		655,00 €	
	AFM45-ON0806-D250-C60-Z14	250	14	60	63	5.5		858,00 €	
	AFM45-ON0806-D315-D60-Z16	315	16	60	63	5.5		1.161,00 €	
	45°								

FACE MILLING TOOLS / PLAN UND ECKMESSERKÖPFE

	CODE / TYP	TOOL DIMENSIONS (mm) <small>MAB</small>					CUTTING INSERT <small>WENDE PLATTE</small>	PRICE / PREIS
		DC	ZEFP	DCON	LF	APMX		
 45°	NEW AFM45C-ON0806-D063-A22-Z08	63	8	22	50	5.5	ON.. 0806..	285,00 €
	AFM45C-ON0806-D080-A27-Z10	80	10	27	50	5.5	FOR ISO INSERT.	404,00 €
	AFM45C-ON0806-D100-A32-Z14	100	14	32	50	5.5		567,00 €
	AFM45C-ON0806-D125-B40-Z18	125	18	40	63	5.5		750,00 €
	AFM45C-ON0806-D160-C40-Z22	160	22	40	63	5.5		939,00 €
 45°	AFM45-XN0906-D063-A22-Z06-H	63	6	22	50	5	XNMU 0906..	246,00 €
	AFM45-XN0906-D080-A27-Z06-H	80	6	27	50	5	FOR TGTC	261,00 €
	AFM45-XN0906-D100-A32-Z07-H	100	7	32	55	5	INSERT.	296,00 €
	AFM45-XN0906-D125-B40-Z08	125	8	40	63	5		349,00 €
 45°	AFM45-SN1306-D050-A22-Z05-H	50	5	22	40	7	SNGX 1306..	199,00 €
	AFM45-SN1306-D063-A22-Z06-H	63	6	22	40	7	FOR TGTC	231,00 €
	AFM45-SN1306-D080-A27-Z07-H	80	7	27	50	7	INSERT.	251,00 €
	AFM45-SN1306-D100-A32-Z08-H	100	8	32	50	7		303,00 €
 66°	AFM66-PN0905-D050-A22-Z05	50	5	22	40	8	PNMU 0905..	188,00 €
	AFM66-PN0905-D063-A22-Z06	63	6	22	40	8	FOR KYCR	221,00 €
	AFM66-PN0905-D080-A27-Z08	80	8	27	50	8	INSERT.	251,00 €
	AFM66-PN0905-D100-A32-Z10	100	10	32	50	8		314,00 €
	AFM66-PN0905-D125-B40-Z12	125	12	40	63	8		414,00 €
 67°	AFM67-PN1105-D050-A22-Z05	50	5	22	50	5		188,00 €
	AFM67-PN1105-D063-A22-Z06	63	6	22	50	5	PNEG 1105..	221,00 €
	AFM67-PN1105-D080-A27-Z08	80	8	27	50	5	FOR ZCC	251,00 €
	AFM67-PN1105-D100-B32-Z10	100	10	32	50	5	INSERT.	314,00 €
	AFM67-PN1105-D125-B40-Z12	125	12	40	63	5		414,00 €
	AFM67-PN1105-D160-C40-Z14	160	14	40	63	5		626,00 €
 75°	AFM75-AP16-D063-A22-Z04-H	63	4	22	40	6		157,00 €
	AFM75-AP16-D080-A27-Z05-H	80	5	27	50	6	AP.. 1604..	181,00 €
	AFM75-AP16-D100-A32-Z06-H	100	6	32	50	6	FOR ISO	216,00 €
	AFM75-AP16-D125-B40-Z07	125	7	40	63	6	INSERT.	287,00 €

FACE MILLING TOOLS / PLAN UND ECKMESSERKÖPFE

	CODE / TYP	TOOL DIMENSIONS (mm) <small>MAß</small>					CUTTING INSERT WENDE PLATTE	PRICE / PREIS
		DC	ZEFP	DCON	LF	APMX		
 <p>75°</p>	AFM75-X012-D050-A22-Z04-H	50	4	22	40	-		156,00 €
	AFM75-X012-D063-A22-Z05-H	63	5	22	40	-	XOMX 1204..	173,00 €
	AFM75-X012-D080-A27-Z06-H	80	6	27	50	-	FOR ISO	215,00 €
							INSERT.	
 <p>88°</p>	AFM88-SN1305-D050-A22-Z04	50	4	22	40	5		159,00 €
	AFM88-SN1305-D050-A22-Z05	50	5	22	40	5	SNMU 1305..	180,00 €
	AFM88-SN1305-D063-A22-Z05	63	5	22	40	5	FOR KYC	185,00 €
	NEW AFM88L-SN1305-D063-A22-Z07	63	7	22	40	5	INSERT.	216,00 €
	AFM88-SN1305-D063-A22-Z07	63	7	22	40	5		216,00 €
	AFM88-SN1305-D080-A27-Z06	80	6	27	50	5		216,00 €
	AFM88-SN1305-D080-A27-Z09	80	9	27	50	5		263,00 €
	AFM88-SN1305-D100-A32-Z07	100	7	32	50	5		241,00 €
	AFM88-SN1305-D100-A32-Z11	100	11	32	50	5		303,00 €
AFM88-SN1305-D125-B40-Z13	125	13	40	63	5		390,00 €	
 <p>88°</p>	AFM88-SN1306-D050-A22-Z05-H	50	5	22	40	5	SNGX 1306..	189,00 €
	AFM88-SN1306-D063-A22-Z06-H	63	6	22	40	5	FOR TGTC	216,00 €
	AFM88-SN1306-D080-A27-Z07-H	80	7	27	50	5	INSERT.	251,00 €
 <p>88°</p>	NEW AFM88C-SN1206-D040-A16-Z04-H	40	4	16	40	11.5	SN.. 1206..	165,00 €
	AFM88C-SN1206-D050-A22-Z05-H	50	5	22	40	11.5	FOR ISO	18400 €
	AFM88C-SN1206-D063-A22-Z06-H	63	6	22	40	11.5	INSERT.	197,00 €
	AFM88C-SN1206-D080-A27-Z07-H	80	7	27	50	11.5		228,00 €
	AFM88C-SN1206-D100-A32-Z09-H	100	9	32	52	11.5		256,00 €
	NEW AFM88C-SN1206-D125-B40-Z10	125	10	40	63	11.5		374,00 €
 <p>88°</p>	AFM88C-SN12..-D063-A22-Z06-H	63	6	22	40	11.5	SN.. 12..	218,00 €
	AFM88C-SN12..-D080-A27-Z07-H	80	7	27	50	11.5	FOR ISO	251,00 €
	AFM88C-SN12..-D100-A32-Z09-H	100	9	32	52	11.5	INSERT.	283,00 €



FACE MILLING TOOLS / PLAN UND ECKMESSERKÖPFE

	CODE / TYP	TOOL DIMENSIONS (mm) <small>MAß</small>					CUTTING INSERT <small>WENDE PLATTE</small>	PRICE / PREIS
		DC	ZEFP	DCON	LF	APMX		
 88°	AFM88C-SN12Z-D063-A22-Z06-H	63	6	22	40	11.5	SNEG 1205..	197,00 €
	AFM88C-SN12Z-D080-A27-Z07-H	80	7	27	50	11.5	FOR ZCC INSERT.	228,00 €
 89°	AFM89-SN1305I-D040-A16-Z04-H	40	4	16	40	10	SNMU 1305..	159,00 €
	AFM89-SN1305I-D050-A22-Z05-H	50	5	22	40	10	SNMU 1305..	189,00 €
	AFM89-SN1305I-D063-A22-Z06-H	63	6	22	40	10	OXMT 0507..	216,00 €
	AFM89-SN1305I-D063-A22-Z07-H	63	7	22	40	10	FOR ISCR	232,00 €
	AFM89-SN1305I-D080-A27-Z08-H	80	8	27	50	10	INSERT.	262,00 €
	AFM89-SN1305I-D100-A32-Z10-H	100	10	32	50	10		306,00 €
 90°	AFM90-AD10T3-D040-A16-Z06-H	40	6	16	40	10	ADMT 10T3..	151,00 €
	AFM90-AD10T3-D050-A22-Z07-H	50	7	22	40	10	FOR WLTR INSERT.	178,00 €
 90°	AFM90-AD1505-D040-A16-Z04-H	40	4	16	40	15		126,00 €
	AFM90-AD1505-D050-A22-Z05-H	50	5	22	40	15	AD.. 1505..	151,00 €
	AFM90-AD1505-D063-A22-Z06-H	63	6	22	40	15	FOR ISCR	173,00 €
	AFM90-AD1505-D080-A27-Z07-H	80	7	27	50	15	INSERT.	197,00 €
	AFM90-AD1505-D100-A32-Z08-H	100	8	32	50	15		240,00 €
	AFM90-AD1505-D125-B40-Z09	125	9	40	63	15		316,00 €
 90°	AFM90-AD1505D-D050-A22-Z05-H	50	5	22	40	14.3		151,00 €
	AFM90-AD1505D-D063-A27-Z06-H	63	6	27	50	14.3	ADKT 150508	173,00 €
	AFM90-AD1505D-D080-A27-Z08-H	80	8	27	50	14.3	FOR DJT	210,00 €
	AFM90-AD1505D-D100-A32-Z08-H	100	8	32	50	14.3	INSERT.	240,00 €
	AFM90-AD1505D-D125-B40-Z09	125	9	40	63	14.3		316,00 €
 90°	AFM90-AN11-D040-A16-Z04-H	40	4	16	40	11	ANGX 1105..	146,00 €
	AFM90-AN1506-D050-A22-Z04-H	50	4	22	40	14.5		153,00 €
	AFM90-AN1506-D063-A22-Z05-H	63	5	22	40	14.5	ANGX 1506..	178,00 €
	AFM90-AN1506-D080-A27-Z06-H	80	6	27	50	14.5	FOR ZCC	201,00 €
	AFM90-AN1506-D100-A32-Z08-H	100	8	32	50	14.5	INSERT.	242,00 €
	AFM90-AN1506-D125-B40-Z09	125	9	40	63	14.5		363,00 €
	AFM90-AN1506-D160-C40-Z10	160	10	40	63	14.5		471,00 €



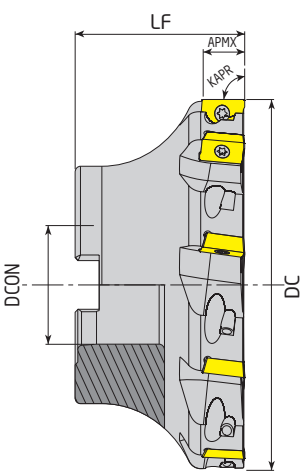

FACE MILLING TOOLS / PLAN UND ECKMESSERKÖPFE

	CODE / TYP	TOOL DIMENSIONS (mm) <small>MAB</small>					CUTTING INSERT WENDE PLATTE	PRICE / PREIS
		DC	ZEFP	DCON	LF	APMX		
 <p>90°</p>	AFM90-AN1607-D050-A22-Z04-H	50	4	22	40	15	AN.X 1607..	195,00 €
	AFM90-AN1607-D063-A22-Z06-H	63	6	22	40	15	FOR TGTC	263,00 €
	AFM90-AN1607-D080-A27-Z07-H	80	7	27	50	15	INSERT.	295,00 €
	AFM90-AN1607-D100-A32-Z08-H	100	8	32	50	15		326,00 €
	AFM90-AN1607-D125-B40-Z10	125	10	40	63	15		434,00 €
 <p>90°</p>	AFM90-AN12-D040-A16-Z04-H	40	4	16	40	12	ANKX 1205..	143,00 €
	AFM90-AN12-D050-A22-Z05-H	50	5	22	40	12	FOR ISCR	170,00 €
	AFM90-AN12-D063-A27-Z06-H	63	6	27	50	12	INSERT.	196,00 €
 <p>90°</p>	AFM90-AN1207-D040-A16-Z04-H	40	4	16	40	10	ANKX 1207..	143,00 €
	AFM90-AN1207-D050-A22-Z05-H	50	5	22	40	10	FOR XTC-GSC	170,00 €
	AFM90-AN1207-D063-A22-Z06-H	63	6	22	40	10	INSERT.	196,00 €
	AFM90-AN1607X-D050-A22-Z04-H	50	4	22	40	15	ANKX 1607..	159,00 €
	AFM90-AN1607X-D063-A22-Z06-H	63	6	22	40	15	FOR XTC-GSC	215,00 €
	AFM90-AN1607X-D080-A27-Z07-H	80	7	27	50	15	INSERT.	240,00 €
 <p>90°</p>	AFM90-A01236-D050-A22-Z05-H	50	5	22	40	12	AO.. 1236..	180,00 €
	AFM90-A01848-D050-A22-Z05-H	50	5	22	40	15	AO.. 1848..	180,00 €
	AFM90-A01848-D063-A22-Z06-H	63	6	22	40	15	FOR MTSBH INSERT.	199,00 €
 <p>90°</p>	AFM90-AP1705-D050-A22-Z05-H	50	5	22	40	16	AP.. 1705..	151,00 €
	AFM90-AP1705-D063-A22-Z06-H	63	6	22	40	16	FOR TGTC-LMNA	173,00 €
	AFM90-AP1705-D080-A27-Z07-H	80	7	27	50	16	INSERT.	197,00 €
	AFM90-AP1705-D100-A32-Z08-H	100	8	32	50	16		240,00 €

FACE MILLING TOOLS / PLAN UND ECKMESSERKÖPFE

	CODE / TYP	TOOL DIMENSIONS (mm) <small>MAß</small>					CUTTING INSERT WENDE PLATTE	PRICE / PREIS
		DC	ZEFP	DCON	LF	APMX		
  90°	NEW AFM90-AP10-D040-A16-Z04-H	40	4	16	35	10		115,00 €
	AFM90-AP10-D040-A16-Z05-H	40	5	16	40	10		119,00 €
	AFM90-AP10-D050-A22-Z06-H	50	6	22	40	10	AP.. 1003..	139,00 €
	NEW AFM90-AP10-D050-A22-Z07-H	50	7	22	40	10	FOR ISO INSERT.	151,00 €
	NEW AFM90-AP10-D063-A22-Z06	63	6	22	40	10		153,00 €
	AFM90-AP10-D063-A22-Z07-H	63	7	22	40	10		156,00 €
	NEW AFM90-AP10-D063-A22-Z09	63	9	22	40	10		192,00 €
	AFM90-AP10-D080-A27-Z08-H	80	8	27	50	10		180,00 €
	AFM90-AP10-D100-A32-Z09-H	100	9	32	50	10		215,00 €
	AFM90-AP16-D040-A16-Z04-H	40	4	16	40	16		115,00 €
	AFM90-AP16-D050-A22-Z05-H	50	5	22	40	16		139,00 €
	AFM90-AP16-D052-A22-Z05-H	52	5	22	40	16		143,00 €
	AFM90-AP16-D063-A22-Z06-H	63	6	22	40	16	AP.. 1604..	156,00 €
	AFM90-AP16-D080-A27-Z07-H	80	7	27	50	16	FOR ISO INSERT.	180,00 €
	AFM90-AP16-D100-A32-Z08-H	100	8	32	50	16		215,00 €
	AFM90-AP16-D125-B40-Z09	125	9	40	63	16		287,00 €
	AFM90-AP16-D160-C40-Z10	160	10	40	63	16		358,00 €
	AFM90-AP16-D200-C60-Z12	200	12	60	63	16		596,00 €
	AFM90-AP16DJ-D050-A22-Z05-H	50	5	22	40	16	AP.. 1604..	139,00 €
	AFM90-AP16DJ-D063-A22-Z06-H	63	6	22	40	16	FOR DJT	156,00 €
	AFM90-AP16DJ-D080-A27-Z07-H	80	7	27	50	16	INSERT.	180,00 €
	AFM90-AP16L-D050-A22-Z05-H	50	5	22	40	16	AP.. 1604..	139,00 €
	AFM90-AP16L-D063-A22-Z06-H	63	6	22	40	16	FOR LMNA INSERT..	156,00 €
	AFM90-AP16L-D080-A27-Z07-H	80	7	27	50	16		180,00 €
	AFM90-AP16P-D040-A16-Z04-H	40	4	16	40	16		115,00 €
	AFM90-AP16P-D050-A22-Z05-H	50	5	22	40	16	AP.. 1604..	139,00 €
	AFM90-AP16P-D063-A22-Z06-H	63	6	22	40	16	FOR PLBT INSERT.	156,00 €
	AFM90-AP16P-D080-A27-Z07-H	80	7	27	50	16		180,00 €
	AFM90-AP16P-D100-A32-Z08-H	100	8	32	50	16		215,00 €
	AFM90-AP16A-D050-A22-Z05-H	50	5	22	40	15		139,00 €
	AFM90-AP16A-D063-A22-Z06-H	63	6	22	40	15	AP.. 1604..	156,00 €
	AFM90-AP16A-D080-A27-Z07-H	80	7	27	50	15	FOR ACHTK	180,00 €
AFM90-AP16A-D100-A32-Z08-H	100	8	32	50	15	INSERT..	215,00 €	
AFM90-AP16A-D125-B40-Z09	125	9	40	63	15		287,00 €	
AFM90-AP16Y-D040-A16-Z04-H	40	4	16	40	16		115,00 €	
AFM90-AP16Y-D050-A22-Z05-H	50	5	22	40	16	AP.. 1604..	139,00 €	
AFM90-AP16Y-D063-A22-Z06-H	63	6	22	40	16	FOR YG	156,00 €	
AFM90-AP16Y-D080-A27-Z07-H	80	7	27	50	16	INSERT.	180,00 €	
AFM90-AP16Y-D100-A32-Z08-H	100	8	32	50	16		215,00 €	
 90°	AFM90-AX1235-D040-A16-Z06-H	40	6	16	40	10	AX.T 1235..	151,00 €
	AFM90-AX1235-D050-A22-Z07-H	50	7	22	40	10	FOR SMTM	173,00 €
	AFM90-AX1235-D063-A22-Z08-H	63	8	22	40	10	INSERT.	197,00 €
	AFM90-AX1235-D080-A27-Z10-H	80	10	27	50	10		250,00 €
	AFM90-AX1705-D040-A16-Z04-H	40	4	16	40	14		131,00 €
	AFM90-AX1705-D050-A22-Z05-H	50	5	22	40	14	AX.T 1705..	158,00 €
	AFM90-AX1705-D063-A22-Z06-H	63	6	22	40	14	FOR SMTM	181,00 €
	AFM90-AX1705-D080-A27-Z07-H	80	7	27	50	14	INSERT.	207,00 €
	AFM90-AX1705-D100-A32-Z08-H	100	8	32	50	14		247,00 €

FACE MILLING TOOLS / PLAN UND ECKMESSERKÖPFE

	CODE / TYP	TOOL DIMENSIONS (mm) <small>MAß</small>					CUTTING INSERT WENDE PLATTE	PRICE / PREIS
		DC	ZEFP	DCON	LF	APMX		
	AFM90-BD11T3-D040-A16-Z04-H	40	4	16	40	10	BDMT 11T3..	139,00 €
	AFM90-BD11T3-D050-A22-Z05-H	50	5	22	40	10	FOR KYCR	168,00 €
	AFM90-BD11T3-D063-A22-Z06-H	63	6	22	40	10	INSERT.	189,00 €
	AFM90-BD1704-D050-A22-Z04-H	50	4	22	40	15.7	BDMT 1704..	146,00 €
	AFM90-BD1704-D050-A22-Z05-H	50	5	22	40	15.7	FOR KYCR	155,00 €
	AFM90-BD1704-D063-A22-Z06-H	63	6	22	40	15.7	INSERT.	170,00 €
	AFM90-BD1704-D080-A27-Z06-H	80	6	27	50	15.7		187,00 €
	AFM90-BD1704-D080-A27-Z07-H	80	7	27	50	15.7		196,00 €
AFM90-BD1704-D100-A32-Z07-H	100	7	32	50	15.7		215,00 €	
	AFM90-LO10-D040-A16-Z05-H	40	5	16	40	10	LOMU 1004..	162,00 €
	AFM90-LO10-D050-A22-Z05-H	50	5	22	40	10	FOR KYCR	174,00 €
	AFM90-LO10-D063-A22-Z06-H	63	6	22	40	10	INSERT.	197,00 €
	AFM90-LO1505-D050-A22-Z04-H	50	4	22	40	15	LOMU 1505..	182,00 €
	AFM90-LO1505-D063-A22-Z05-H	63	5	22	40	15	FOR KYCR	211,00 €
						INSERT.		
	AFM90-LN1506X-D063-A22-Z06	63	6	22	40	7	LNMT 1506..	197,00 €
	AFM90-LN1506X-D080-A27-Z07	80	7	27	50	7	FOR XTC-GSC	250,00 €
	AFM90-LN1506X-D100-A32-Z08	100	8	32	50	7	INSERT	305,00 €
	AFM90-LN1106-D050-A22-Z05	50	5	22	40	10		170,00 €
	AFM90-LN1106-D063-A22-Z06	63	6	22	40	10		197,00 €
	AFM90-LN1106-D080-A27-Z08	80	8	27	50	10	LNMT 1106..	250,00 €
	AFM90L-LN1106-D080-A27-Z08	80	8	27	50	10	FOR ISCR	250,00 €
	AFM90-LN1106-D100-A32-Z09	100	9	32	50	10	INSERT.	305,00 €
	AFM90L-LN1106-D100-A32-Z09	100	9	32	50	10		305,00 €
	AFM90-LN1106-D125-B40-Z10	125	10	40	63	10		397,00 €
	AFM90-LN1306-D040-A16-Z04-H	40	4	16	40	12.5	T490	143,00 €
	AFM90-LN1306-D050-A22-Z05-H	50	5	22	40	12.5	LNMT 1306..	170,00 €
	AFM90-LN1306-D063-A22-Z06-H	63	6	22	40	12.5	FOR ISCR	197,00 €
	AFM90-LN1306-D080-A27-Z07-H	80	7	27	50	12.5	INSERT.	250,00 €
	AFM90-LN1306-D100-A32-Z08-H	100	8	32	50	12.5		305,00 €
	AFM90L-LN1506-D040-A16-Z04	40	4	16	40	14		143,00 €
	AFM90-LN1506-D040-A16-Z04	40	4	16	40	14	LNMT 1506..	143,00 €
	AFM90-LN1506-D050-A22-Z05	50	5	22	40	14	FOR ISCR	170,00 €
	AFM90-LN1506-D063-A22-Z06	63	6	22	40	14	INSERT.	197,00 €
	AFM90-LN1506-D080-A27-Z07	80	7	27	50	14		250,00 €
	AFM90-LN1607-D050-A22-Z03-H	50	3	22	40	16		170,00 €
	AFM90-LN1607-D063-A22-Z04-H	63	4	22	40	16	LNHT 1607..	197,00 €
	AFM90-LN1607-D080-A27-Z05-H	80	5	27	50	16	FOR ISCR	250,00 €
AFM90-LN1607-D100-A32-Z06-H	100	6	32	50	16	INSERT.	305,00 €	
	NEW AFM90-LN1306W-D040-A16-Z04-H	40	4	16	40	12	LNHU 1306..	143,00 €
	AFM90-LN1306W-D050-A22-Z05-H	50	5	22	40	12	FOR WLTR	170,00 €
	AFM90-LN1306W-D063-A22-Z06-H	63	6	22	40	12	INSERT	197,00 €
	AFM90-LN1306W-D080-A27-Z07-H	80	7	27	50	12		250,00 €
	NEW AFM90-LN1306W-D100-A32-Z08-H	100	8	32	50	12		305,00 €





FACE MILLING TOOLS / PLAN UND ECKMESSERKÖPFE

	CODE / TYP	TOOL DIMENSIONS (mm) <small>MAB</small>					CUTTING INSERT <small>WENDE PLATTE</small>	PRICE / PREIS
		DC	ZEFP	DCON	LF	APMX		
 90°	AFM90-LN1307-D050-A22-Z04-H	50	4	22	40	13	LNGX 1307..	218,00 €
	AFM90-LN1307-D063-A22-Z06-H	63	6	22	40	13	FOR WLTR	261,00 €
	AFM90-LN1307-D080-A27-Z07-H	80	7	27	50	13	INSERT	286,00 €
	AFM90-LN1307-D100-A32-Z08-H	100	8	32	50	13		309,00 €
 90°	AFM90-LN15Z-D050-A22-Z04	50	4	22	40	15	LNKT 1506..	170,00 €
	AFM90-LN15Z-D063-A22-Z05	63	5	22	40	15	FOR ZCC	197,00 €
	AFM90-LN15Z-D080-A27-Z06	80	6	27	50	15	INSERT	226,00 €
	AFM90-LN15Z-D100-A32-Z07	100	7	32	50	15		282,00 €
	AFM90-LN15Z-D125-B40-Z08	125	8	40	63	15		372,00 €
 90°	AFM90-LO08-D040-A16-Z06-H	40	6	16	40	2	LOEX 0804..	207,00 €
	AFM90-LO08-D050-A22-Z07-H	50	7	22	40	2	FOR SC	234,00 €
	AFM90-LO08-D063-A27-Z06-H	63	6	27	40	2	INSERT.	227,00 €
 90°	NEW AFM90-LO09-D040-A16-Z06-H	40	6	16	40	8	LOGU 0904..	175,00 €
	NEW AFM90-LO09-D050-A22-Z05-H	50	5	22	40	8	FOR MTSBSH	168,00 €
	NEW AFM90-LO09-D050-A22-Z07-H	50	7	22	40	8	INSERT	201,00 €
	NEW AFM90-LO09-D063-A22-Z06-H	63	6	22	40	8		210,00 €
	AFM90-LO1207-D040-A16-Z04-H	40	4	16	40	11	LOGU 1207..	143,00 €
	AFM90-LO1207-D050-A22-Z05-H	50	5	22	40	11	FOR MTSBSH	170,00 €
	AFM90-LO1207-D063-A22-Z05-H	63	5	22	40	11	INSERT	186,00 €
	NEW AFM90-LO1207-D063-A22-Z06-H	63	6	22	40	11		211,00 €
	NEW AFM90-LO1207-D080-A27-Z07-H	80	7	27	50	11		280,00 €
NEW AFM90-LO1207-D100-A32-Z07-H	100	7	32	50	11		339,00 €	
 90°	AFM90-LN15T6-D050-A22-Z05-H	50	5	22	40	15.5	LNGU 15T6..	170,00 €
	AFM90-LN15T6-D063-A22-Z06-H	63	6	22	40	15.5	FOR KNMTL	196,00 €
	AFM90-LN15T6-D080-A27-Z07-H	80	7	27	50	15.5	INSERT	223,00 €
 90°	AFM90-R290.12-D050-A22-Z04-H	50	4	22	40	10.7		143,00 €
	AFM90-R290.12-D063-A22-Z05-H	63	5	22	40	10.7	R290-12T3..	168,00 €
	AFM90-R290.12-D080-A27-Z07-H	80	7	27	50	10.7	FOR SNDVK	192,00 €
	AFM90-R290.12-D100-A32-Z09-H	100	9	32	50	10.7	INSERT.	240,00 €
	AFM90-R290.12-D125-B40-Z11	125	11	40	63	10.7		316,00 €

FACE MILLING TOOLS / PLAN UND ECKMESSERKÖPFE

	CODE / TYP	TOOL DIMENSIONS (mm) <small>MAG</small>					CUTTING INSERT WENDE PLATTE	PRICE / PREIS	
		DC	ZEFP	DCON	LF	APMX			
  90°	AFM90-R390.11-D040-A16-Z05-H	40	5	16	40	10	R390-11T3..	126,00 €	
	AFM90-R390.11-D050-A22-Z06-H	50	6	22	40	10	FOR SNDVK	151,00 €	
	AFM90-R390.11-D063-A22-Z07-H	63	7	22	40	10	INSERT.	173,00 €	
	AFM90-R390.11-D080-A27-Z09-H	80	9	27	50	10		226,00 €	
	AFM90-R390.17-D040-A16-Z04-H	40	4	16	40	15.4		126,00 €	
	AFM90-R390.17-D050-A22-Z05-H	50	5	22	40	15.4	R390-1704..	151,00 €	
	AFM90-R390.17-D063-A22-Z06-H	63	6	22	40	15.4	FOR SNDVK	173,00 €	
	AFM90-R390.17-D080-A27-Z07-H	80	7	27	50	15.4	INSERT.	197,00 €	
	AFM90-R390.17-D100-A32-Z08-H	100	8	32	50	15.4		240,00 €	
	AFM90-R390.17-D125-B40-Z09	125	9	40	63	15.4		316,00 €	
	AFM90-R390.18-D050-A22-Z04-H	50	4	22	40	15.4		151,00 €	
	AFM90-R390.18-D063-A22-Z05-H	63	5	22	40	15.4	R390-1806..	173,00 €	
	AFM90-R390.18-D080-A27-Z06-H	80	6	27	50	15.4	FOR SNDVK	197,00 €	
	AFM90-R390.18-D100-A32-Z07-H	100	7	32	50	15.4	INSERT.	240,00 €	
AFM90-R390.18-D125-B40-Z08	125	8	40	63	15.4		316,00 €		
 90°	AFM90-490R08-D063-A22-Z06-H	63	6	22	40	5.5	490R-08T3..	240,00 €	
	AFM90-490R14-D050-A22-Z04-H	50	4	22	40	10		197,00 €	
	AFM90-490R14-D063-A22-Z05-H	63	5	22	40	10	490R-1404..	231,00 €	
	AFM90-490R14-D080-A27-Z07-H	80	7	27	50	10	FOR SNDVK	262,00 €	
	AFM90-490R14-D100-A32-Z07-H	100	7	32	50	10	INSERT..	276,00 €	
	AFM90-490R14-D125-B40-Z08	125	8	40	63	10		362,00 €	
	<small>NEW</small> AFM90-490R14-D125-B40-Z12								432,00 €
	AFM90-490R14-D160-C40-Z12	160	12	40	63	10		472,00 €	
	AFM90-490R14-D200-C60-Z16	250	16	60	63	10		765,00 €	
 90°	AFM90-RT10-D040-A16-Z06-H	40	6	16	40	10	RT 1003..	126,00 €	
	AFM90-RT10-D050-A22-Z07-H	50	7	22	40	10	FOR SFTY	148,00 €	
	AFM90-RT10-D063-A22-Z09-H	63	9	22	50	10	INSERT.	181,00 €	
	<small>NEW</small> AFM90-RT16-D040-A16-Z04-H	40	4	16	40	16	RT 1606..	127,00 €	
	<small>NEW</small> AFM90-RT16-D063-A22-Z06-H	63	6	22	40	16	FOR SFTY	171,00 €	
	<small>NEW</small> AFM90-RT16-D080-A27-Z07-H	80	7	27	50	16	INSERT.	197,00 €	
	<small>NEW</small> AFM90-RT16-D125-B40-Z09	125	9	40	63	16		315,00 €	
 90°	AFM90S-SD1204-D050-A22-Z04-H	50	4	22	40	11		222,00 €	
	AFM90S-SD1204-D063-A22-Z05-H	63	5	22	40	11	SDMT 1204..	262,00 €	
	AFM90S-SD1204-D080-A27-Z06-H	80	6	27	50	11	FOR	292,00 €	
	AFM90S-SD1204-D100-A32-Z08-H	100	8	32	50	11	DJT INSERT.	375,00 €	
	AFM90S-SD1204-D125-B40-Z10	125	10	40	63	11		489,00 €	
	AFM90S-SD1204-D160-C40-Z12	160	12	40	63	11		607,00 €	
 90°	AFM90-SD09M4-D040-A16-Z04-H	40	4	16	40	9		144,00 €	
	AFM90-SD09M4-D050-A22-Z05-H	50	5	22	40	9	SD.. 09M4..	156,00 €	
	AFM90-SD09M4-D063-A22-Z06-H	63	6	22	40	9	FOR KRLY	180,00 €	
	AFM90-SD09M4-D063-A27-Z06-H	63	6	27	40	9	INSERT.	180,00 €	
	AFM90-SD09M4-D080-A27-Z07-H	80	7	27	50	9		210,00 €	
	AFM90-SD1305-D050-A22-Z04-H	50	4	22	40	13		156,00 €	
	AFM90-SD1305-D063-A22-Z05-H	63	5	22	40	13	SD.. 1305..	180,00 €	
	AFM90-SD1305-D080-A27-Z06-H	80	6	27	50	13	FOR KRLY	210,00 €	
	AFM90-SD1305-D100-A32-Z07-H	100	7	32	50	13	INSERT.	256,00 €	
	AFM90-SD1305-D125-B40-Z08	125	8	40	63	13		341,00 €	
	AFM90-SD1305-D160-C40-Z10	160	10	40	63	13		417,00 €	

FACE MILLING TOOLS / PLAN UND ECKMESSERKÖPFE

	CODE / TYP	TOOL DIMENSIONS (mm) <small>MAS</small>					CUTTING INSERT WENDE PLATTE	PRICE / PREIS
		DC	ZEFP	DCON	LF	APMX		
 90°	AFM90-TNG10-D040-A16-Z04-H	40	4	16	40	5		144,00 €
	AFM90-TNG10-D040-A16-Z06-H	40	6	16	40	5		168,00 €
	AFM90-TNG10-D050-A22-Z05-H	50	5	22	40	5		174,00 €
	AFM90-TNG10-D050-A22-Z07-H	50	7	22	40	5		200,00 €
	AFM90-TNG10-D063-A22-Z06-H	63	6	22	40	5	TNGX 1004..	194,00 €
	AFM90-TNG10-D063-A22-Z09-H	63	9	22	40	5	FOR PRMT	240,00 €
	AFM90-TNG10-D080-A27-Z10-H	80	10	27	50	5	INSERT	276,00 €
	AFM90-TNG16-D040-A16-Z03-H	40	3	16	40	10		121,00 €
	AFM90-TNG16-D040-A16-Z04-H	40	4	16	40	10		144,00 €
	AFM90-TNG16-D050-A22-Z04-H	50	4	22	40	10		158,00 €
	AFM90-TNG16-D050-A22-Z05-H	50	5	22	40	10		174,00 €
	AFM90-TNG16-D063-A22-Z04-H	63	4	22	40	10		168,00 €
	AFM90-TNG16-D063-A22-Z06-H	63	6	22	40	10		194,00 €
	AFM90-TNG16-D080-A27-Z05-H	80	5	27	50	10		200,00 €
	AFM90-TNG16-D080-A27-Z07-H	80	7	27	50	10	TNGX 1606..	224,00 €
	AFM90-TNG16-D100-A32-Z06-H	100	6	32	50	10	FOR PRMT	246,00 €
	AFM90-TNG16-D100-A32-Z08-H	100	8	32	50	10	INSERT	269,00 €
	AFM90-TNG16-D115-A32-Z06-H	115	6	32	50	10		287,00 €
	AFM90-TNG16-D125-A40-Z07-H	125	7	40	63	10		339,00 €
	AFM90-TNG16-D125-A40-Z09-H	125	9	40	63	10		358,00 €
AFM90-TNG16-D140-B40-Z08-H	140	8	40	63	10		398,00 €	
AFM90-TNG16-D160-C40-Z10-H	160	10	40	63	10		466,00 €	
AFM90-TNG16-D175-C40-Z10-H	175	10	40	63	10		509,00 €	
 90°	AFM90-SE09-D040-A16-Z04-H	40	4	16	40	6.7	SEET 09T3..	139,00 €
	AFM90-SE09-D050-A22-Z05-H	50	5	22	40	6.7	FOR ZCC	162,00 €
	AFM90-SE09-D063-A22-Z06-H	63	6	22	40	6.7	INSERT.	185,00 €
 90°	AFM90-SE12-D050-A22-Z04-H	50	4	22	40	12		143,00 €
	AFM90-SE12-D063-A22-Z05-H	63	5	22	40	12	SEET 1203..	168,00 €
	AFM90-SE12-D080-A27-Z07-H	80	7	27	50	12	FOR ZCC	192,00 €
	AFM90-SE12-D100-A32-Z09-H	100	9	32	50	12	INSERT.	240,00 €
	AFM90-SE12-D125-B40-Z11	125	11	40	63	12		316,00 €
 90°	AFM90-SP1004-D040-A16-Z04-H	40	4	16	40	9.4	SPMT 1004..	144,00 €
	AFM90-SP1004-D050-A22-Z04-H	50	4	22	40	9.4	XPMT 1004..	162,00 €
	AFM90-SP1004-D050-A22-Z06-H	50	6	22	40	9.4	QPMR 1004..	180,00 €
	AFM90-SP1004-D063-A22-Z05-H	63	5	22	40	9.4	QPMT 1004..	182,00 €
	AFM90-SP1004-D080-A27-Z07-H	80	7	27	50	9.4	FOR ISCR	227,00 €
	AFM90-SP1004-D100-A32-Z08-H	100	8	32	50	9.4	INSERT.	256,00 €



FACE MILLING TOOLS / PLAN UND ECKMESSERKÖPFE

	CODE / TYP	TOOL DIMENSIONS (mm) <small>MAß</small>					CUTTING INSERT WENDE PLATTE	PRICE / PREIS
		DC	ZEFP	DCON	LF	APMX		
 <p>90°</p>	AFM90-SP09T3-D040-A16-Z05-H	40	5	16	40	8.6	SPMT 09T30..	162,00 €
	AFM90-SP09T3-D050-A22-Z06-H	50	6	22	40	8.6	FOR SNDVK	173,00 €
	AFM90-SP09T3-D063-A22-Z07-H	63	7	22	40	8.6	INSERT.	197,00 €
	AFM90-SP09T3-D080-A27-Z08-H	80	8	27	50	8.6		227,00 €
 <p>90°</p>	AFM90-TN2207-D063-A22-Z04-H	63	4	22	40	15	TN.X 2207..	200,00 €
	AFM90-TN2207-D080-A27-Z05-H	80	5	27	50	15	FOR TGTC	245,00 €
	AFM90-TN2207-D100-B32-Z06	100	6	32	50	15	INSERT.	295,00 €
	AFM90-TN2207-D125-B40-Z08	125	8	40	63	15		389,00 €
 <p>90°</p>	AFM90-TP2205-D063-A22-Z04	63	4	22	40	18	TPKT 2205..	188,00 €
	AFM90-TP2205-D080-A27-Z06	80	6	27	50	18	FOR TGTC	221,00 €
	AFM90-TP2205-D100-A32-Z07	100	7	32	50	18	INSERT.	270,00 €
	AFM90-TP2205-D125-B40-Z08	125	8	40	63	18		363,00 €
	AFM90-TP2205-D160-C40-Z09	160	9	40	63	18		489,00 €
	AFM90-TP2205-D200-C60-Z12	200	12	60	63	18		681,00 €
 <p>90°</p>	AFM90-VC2205-D050-A22-Z03-H	50	5	22	55	15	VCKT 2205..	153,00 €
	AFM90-VC2205-D063-A22-Z04-H	63	6	22	55	15	FOR KRLY	171,00 €
	AFM90-VC2205-D066-A27-Z04-H	66	7	27	55	15	INSERT.	171,00 €
	AFM90-VC2205-D080-A27-Z05-H	80	8	27	60	15		197,00 €
 <p>90°</p>	AFM90-WNG04-D040-A16-Z04-H	40	4	16	40	4		185,00 €
	AFM90-WNG04-D040-A16-Z06-H	40	6	16	40	4	WNGU 0403..	197,00 €
	AFM90-WNG04-D050-A22-Z05-H	50	5	22	40	4	FOR XTC-GSC	194,00 €
	AFM90-WNG04-D050-A22-Z07-H	50	7	22	40	4	INSERT.	205,00 €
	AFM90-WNG04-D063-A22-Z06-H	63	6	22	40	4		209,00 €
	AFM90-WNG08-D050-A22-Z05-H	50	5	22	40	7,5		194,00 €
	AFM90-WNG08-D063-A22-Z06-H	63	6	22	40	7,5	WNGU 0806..	209,00 €
	AFM90-WNG08-D080-A27-Z07-H	80	7	27	50	7,5	FOR XTC-GSC	216,00 €
	AFM90-WNG08-D100-A32-Z07-H	100	10	32	50	7,5	INSERT.	240,00 €





FACE MILLING TOOLS / PLAN UND ECKMESSERKÖPFE

	CODE / TYP	TOOL DIMENSIONS (mm) <small>MAS</small>					CUTTING INSERT <small>WENDE PLATTE</small>	PRICE / PREIS
		DCX	ZEFP	DCON	LF	APMX		
 90°	AFM90-WN0604Z-D040-A16-Z04-H	40	4	16	40	5.7	FOR WNHU	185,00 €
	AFM90-WN0604Z-D050-A22-Z05-H	50	5	22	40	5.7	0604..	194,00 €
	AFM90-WN0604Z-D063-A22-Z06-H	63	6	22	40	5.7	FOR ZCC	209,00 €
	AFM90-WN0604Z-D080-A27-Z07-H	80	7	27	50	5.7	INSERT.	224,00 €
	AFM90-WN0604Z-D100-A32-Z09-H	100	9	32	50	5.7		283,00 €
	AFM90-WN0806Z-D050-A22-Z04-H	50	4	22	40	7.7		185,00 €
	AFM90-WN0806Z-D063-A22-Z05-H	63	5	22	40	7.7	WNHU 0806..	194,00 €
	AFM90-WN0806Z-D080-A27-Z06-H	80	6	27	50	7.7	FOR ZCC	200,00 €
	AFM90-WN0806Z-D100-A32-Z08-H	100	8	32	50	7.7	INSERT.	254,00 €
	AFM90-WN0806Z-D125-B40-Z10	125	10	40	63	7.7		331,00 €
AFM90-WN0806Z-D160-C40-Z12	160	12	40	63	7.7		462,00 €	
 90°	AFM90-WN0806-D050-A16-Z04-H	50	4	16	40	8	WNMX 080608	207,00 €
	AFM90-WN0806-D063-A22-Z05-H	63	5	22	40	8	FOR KYCR-JD	248,00 €
	AFM90-WN0806-D080-A27-Z07-H	80	7	27	50	8	INSERT.	299,00 €
 90°	AFM90-XN0403-D040-A16-Z05-H	40	5	16	40	4	XNEX 0403..	151,00 €
	AFM90-XN0806-D050-A22-Z04-H	50	4	22	40	7.5	XNEX 0806..	151,00 €
	AFM90-XN0806-D063-A22-Z05-H	63	5	22	40	7.5	FOR SC INSERT.	173,00 €
	AFM90-XN0806-D080-A27-Z07-H	80	7	27	50	7.5		222,00 €
	AFM90-XN0806-D100-A32-Z08-H	100	8	32	50	7.5		256,00 €
 90°	AFM90-X012-D040-A16-Z05-H	40	5	16	40	11		115,00 €
	AFM90-X012-D050-A22-Z07-H	50	7	22	40	11	XO.. 1204..	151,00 €
	AFM90-X012-D063-A22-Z08-H	63	8	22	40	11	FOR SC INSERT.	168,00 €
	AFM90-X012-D080-A27-Z10-H	80	10	27	50	11		202,00 €
	AFM90-X012-D100-A32-Z12-H	100	12	32	50	11		256,00 €
 90°	AFM90-3P1004-D040-A16-Z05-H	40	5	16	40	7	3PKT 1004..	138,00 €
	AFM90-3P1004-D050-A22-Z06-H	50	6	22	40	7	FOR TGTC INSERT.	166,00 €
	AFM90-3P1505-D050-A22-Z04-H	50	4	22	40	11		138,00 €
	AFM90-3P1505-D050-A22-Z05-H	50	5	22	40	11		162,00 €
	AFM90-3P1505-D063-A22-Z04-H	63	4	22	40	11	3PKT 1505..	156,00 €
	AFM90-3P1505-D063-A22-Z06-H	63	6	22	40	11	FOR TGTC	173,00 €
	AFM90-3P1505-D080-A27-Z07-H	80	7	27	50	11	INSERT.	233,00 €
	AFM90-3P1505-D100-A32-Z08-H	100	8	32	50	11		280,00 €
	AFM90-3P1505-D125-B40-Z10	125	10	40	63	11		354,00 €

FACE MILLING TOOLS / PLAN UND ECKMESSERKÖPFE

	CODE / TYP	TOOL DIMENSIONS (mm) <small>MAB</small>					CUTTING INSERT WENDE PLATTE	PRICE / PREIS
		DC	ZEFP	DON	LF	APMX		
 90°	AFM90-4N06-D040-A16-Z05-H	40	5	16	40	6	4NKT 0603..	138,00 €
	AFM90-4N06-D050-A22-Z06-H	50	6	22	40	6	FOR TGTC INSERT.	166,00 €
 90°	AFM90-6N09-D050-A22-Z05-H	50	5	22	40	9	6NGU 0905..	194,00 €
	AFM90-6N09-D063-A22-Z06-H	63	6	22	40	9	FOR MTSBH	209,00 €
	AFM90-6N09-D080-A27-Z07-H	80	7	27	50	9	INSERT.	224,00 €
	AFM90-6N09-D100-A32-Z08-H	100	8	32	50	9		254,00 €
	AFM90-6N14-D050-A22-Z04-H	50	4	22	50	8.2	6NMU 1409..	164,00 €
	AFM90-6N14-D063-A22-Z05-H	63	5	22	40	8.2	FOR MTSBH	209,00 €
	AFM90-6N14-D080-A27-Z07-H	80	7	27	50	8.2	INSERT.	225,00 €
	AFM90-6N14-D100-A32-Z07-H	100	7	32	50	8.2		255,00 €
AFM90-6N14-D125-B40-Z08	125	8	40	63	8.2		363,00 €	

FACE AND COPY MILLING TOOLS / MESSERKÖPFE FÜR RUNGE WENDESCHNEIDPLATTEN

	CODE / TYP	TOOL DIMENSIONS (mm) <small>MAB</small>					CUTTING INSERT WENDE PLATTE	PRICE / PREIS
		DCX	ZEFP	DON	LF	APMX		
 10°	AFMR-RC10T3-D040-A16-Z04-H	40	4	16	40	5	RC.. 10T3..	131,00 €
	AFMR-RC10T3-D050-A22-Z05-H	50	5	22	50	5	FOR ZCC	157,00 €
	AFMR-RC10T3-D063-A22-Z06-H	63	6	22	50	5	INSERT.	181,00 €
 10°	AFMR-RC1204-D040-A16-Z04-H	40	4	16	40	6	RC.. 1204..	162,00 €
	AFMR-RC1204-D050-A22-Z05-H	50	5	22	50	6	DOR SNDVK	179,00 €
	AFMR-RC1204-D052-A22-Z05-H	52	5	22	50	6	INSERT.	192,00 €
	AFMR-RC1204-D063-A22-Z06-H	63	6	22	50	6		205,00 €
	AFMR-RC1204-D063-A27-Z06-H	63	6	27	50	6		205,00 €
	AFMR-RC1204-D080-A27-Z07-H	80	7	27	50	6		240,00 €
 10°	AFMR-RP10T3-D063-A22-Z06-H	63	6	22	40	5	RPNX 10T3..	169,00 €
	AFMR-RP10T3-D080-A27-Z07-H	80	7	27	50	5	FOR CRTZT INSERT.	196,00 €
	AFMR-RP1204-D040-A16-Z04-H	40	4	16	40	6	RPNX 1204..	124,00 €
	AFMR-RP1204-D080-A27-Z07-H	80	7	27	50	6	FOR CRTZT INSERT.	196,00 €
 10°	NEW AFMR-RP1204M-D042-A16-Z04-H	40	4	16	40	6	RPMT 1204..	140,00 €
	AFMR-RP1204M-D050-A22-Z04-H	50	4	22	50	6	FOR MTSBSH	143,00 €
	AFMR-RP1204M-D052-A22-Z05-H	52	5	22	50	6	INSERT.	151,00 €
	AFMR-RP1204M-D063-A22-Z05-H	63	5	22	50	6		155,00 €
	AFMR-RP1204M-D080-A27-Z06-H	80	6	27	50	6		180,00 €

FACE AND COPY MILLING TOOLS / MESSERKÖPFE FÜR RUNGE WENDESCHNEIDPLATTEN

	CODE / TYP	TOOL DIMENSIONS (mm) <small>MAß</small>					CUTTING INSERT WENDE PLATTE	PRICE / PREIS
		DCX	ZEFP	DCON	LF	APMX		
	AFMR-RY10-D040-A16-Z04-H	40	4	16	40	5	RYMX 1004..	124,00 €
	AFMR-RY10-D040-A16-Z05-H	40	5	16	40	5	FOR TGTC	145,00 €
	AFMR-RY10-D050-A22-Z05-H	50	5	22	50	5	INSERT.	156,00 €
	AFMR-RY10-D063-A22-Z06-H	63	6	22	50	5		192,00 €
	AFMR-RY12-D040-A16-Z04-H	40	4	16	40	6		124,00 €
	AFMR-RY12-D050-A22-Z05-H	50	5	22	50	6	RYMX 1205..	156,00 €
	AFMR-RY12-D052-A22-Z05-H	52	5	22	50	6	FOR TGTC	156,00 €
	AFMR-RY12-D063-A22-Z06-H	63	6	22	50	6	INSERT.	192,00 €
	AFMR-RY12-D080-A27-Z06-H	80	6	27	50	6		202,00 €
AFMR-RY12-D100-A32-Z07-H	100	7	32	50	6		255,00 €	
	AFMR-QP10T3-D040-A16-Z04-H	40	4	16	40	5	QP.. 10T3..	153,00 €
	AFMR-QP10T3-D050-A22-Z05-H	50	5	22	40	5	FOR SMTM	181,00 €
	AFMR-QP10T3-D063-A22-Z06-H	63	6	22	40	5	INSERT.	207,00 €
	AFMR-QP1204-D050-A22-Z04-H	50	4	22	40	6	QP.. 1204..	181,00 €
	AFMR-QP1204-D063-A22-Z05-H	63	5	22	40	6	FOR SMTM	207,00 €
	AFMRC-RO20-D063-A22-Z05-H	63	5	22	50	10	ROMX 2006	186,00 €
	AFMRC-RO20-D080-A27-Z06-H	80	6	27	50	10	FOR WLTR	233,00 €
							INSERT.	

Cutting Calculation : P 166 / Schnittdatenberechnung : S 166

Ordering Example/Beispiel Bestellformular: 1pcs. AFMR-RY10-D040-A16-Z04-H

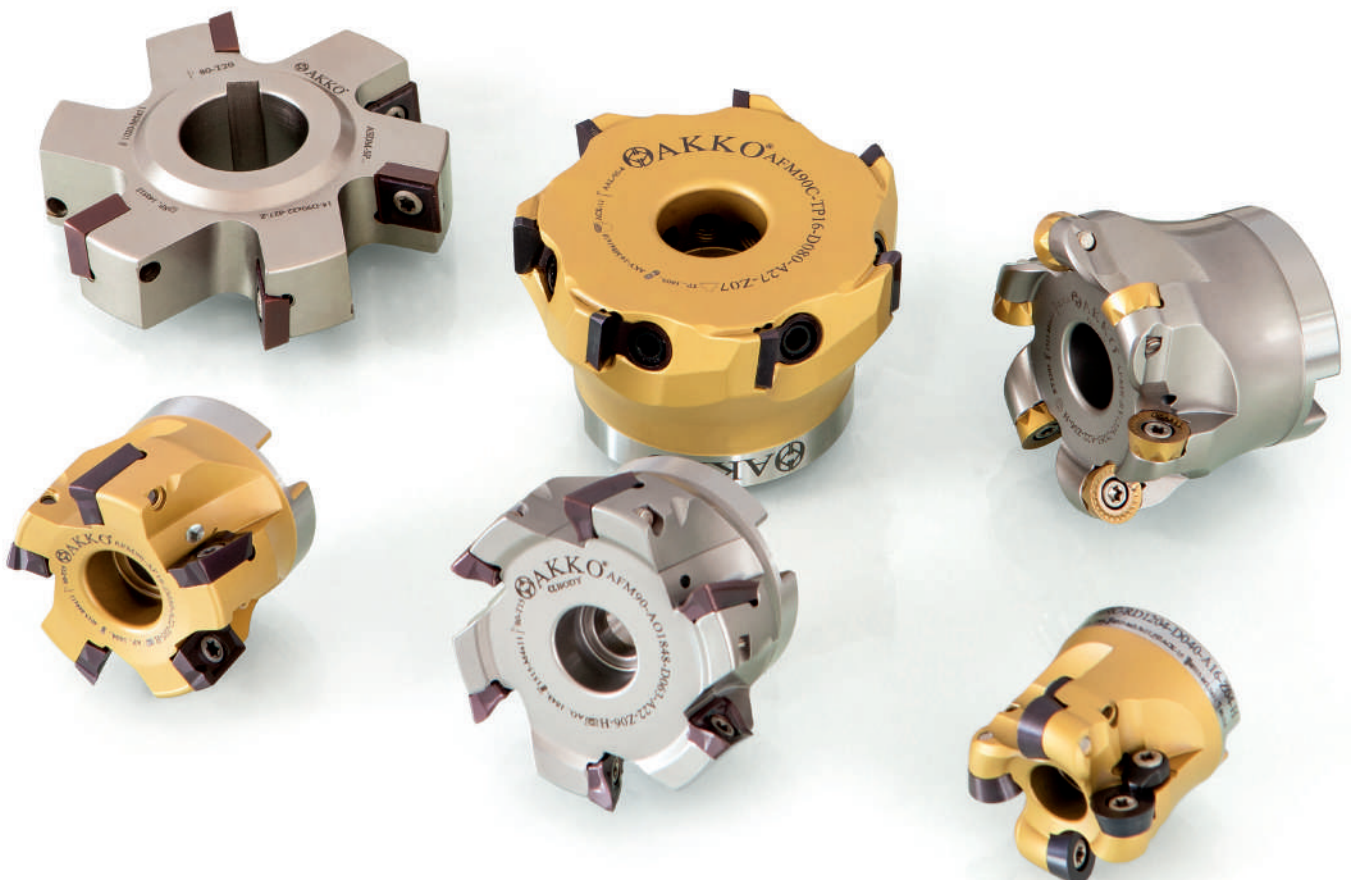

FACE AND COPY MILLING TOOLS / MESSERKÖPFE FÜR RUNGE WENDESCHNEIDPLATTEN

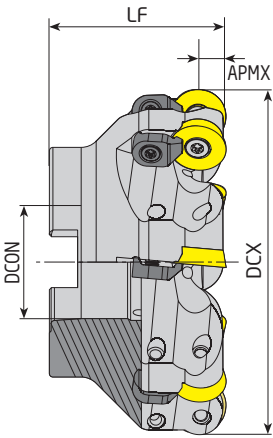
	CODE / TYP	TOOL DIMENSIONS (mm) <small>MAß</small>					CUTTING INSERT WENDE PLATTE	PRICE / PREIS
		DCX	ZEFP	DCON	LF	APMX		
 	AFMR-RD0702-D050-A22-Z06-H	50	6	22	40	3,5	RD.. 0702..	166,00 €
	AFMR-RD0803-D050-A22-Z05-H	50	5	22	40	4	RD.. 0803..	166,00 €
	NEW AFMRC-RD1003-D040-A16-Z04-H	40	4	16	40	5		124,00 €
	AFMRC-RD1003-D040-A16-Z04-H	40	4	16	40	5	RD.. 1003..	124,00 €
	AFMRC-RD1003-D050-A22-Z05-H	50	5	22	40	5	FOR ISO INSERT.	145,00 €
	AFMRC-RD1003-D052-A22-Z05	52	5	22	50	5		145,00 €
	AFMRC-RD1003-D063-A22-Z06-H	63	6	22	40	5		169,00 €
	NEW AFMRC-RD1003-D066-A27-Z07-H	66	7	27	50	5		186,00 €
	AFMRC-RD1003-D080-A27-Z07-H	80	7	27	50	5		196,00 €
	AFMRC-RD1003-D100-A32-Z08-H	100	8	32	50	5		241,00 €
	NEW AFMR-RD1004-D063-A22-Z06-H	63	6	22	50	50	RD.. 1004.. ISO	169,00 €
	NEW AFMRC-RD10T3-D040-A16-Z05-H	40	5	16	40	5		140,00 €
	NEW AFMRC-RD10T3-D042-A16-Z05-H	42	5	16	40	5	RD.. 10T3..	140,00 €
	AFMRC-RD10T3-D050-A22-Z05-H	50	5	22	50	5	FOR ISO INSERT.	145,00 €
	NEW AFMRC-RD10T3-D052-A22-Z06-H	52	6	22	40	5		164,00 €
	NEW AFMRC-RD10T3-D063-A22-Z06-H	63	6	22	50	5		169,00 €
	NEW AFMR-RD12T3-D066-A27-Z06-H	66	6	22	50	5		169,00 €
	AFMRC-RD12T3-D040-A16-Z04-H	40	4	16	40	6		124,00 €
	AFMRC-RD12T3-D050-A22-Z05-H	50	5	22	40	6		145,00 €
	AFMRC-RD12T3-D052-A22-Z05-H	52	5	22	40	6	RD.. 12T3..	145,00 €
	AFMRC-RD12T3-D063-A22-Z06-H	63	6	22	40	6	FOR ISO INSERT.	169,00 €
	AFMRC-RD12T3-D080-A27-Z07-H	80	7	27	50	6		196,00 €
	AFMRC-RD12T3-D100-A32-Z08-H	100	8	32	50	6		241,00 €
	AFMRC-RD12T3-D125-B40-Z09	125	9	40	63	6		319,00 €
	AFMRC-RD1204-D040-A16-Z04-H	40	4	16	40	6		124,00 €
	AFMRC-RD1204-D042-A16-Z04-H	42	4	16	40	6		124,00 €
	NEW AFMRC-RD1204-D050-A22-Z05-H	50	5	22	40	6	RD.. 1204..	145,00 €
	AFMRC-RD1204-D052-A22-Z05-H	52	5	22	40	6	FOR ISO INSERT.	145,00 €
	AFMRC-RD1204-D063-A22-Z06-H	63	6	22	40	6		169,00 €
	AFMRC-RD1204-D080-A27-Z07-H	80	7	27	50	6		196,00 €
	AFMRC-RD1204-D100-A32-Z07-H	100	7	32	50	6		228,00 €
	AFMRC-RD1204-D100-A32-Z08-H	100	8	32	50	6		241,00 €
	AFMRC-RD1604-D050-A22-Z04-H	50	4	22	40	8		157,00 €
	AFMRC-RD1604-D052-A22-Z04-H	52	4	22	50	8		157,00 €
AFMRC-RD1604-D063-A22-Z05-H	63	5	22	40	8	RD.. 1604..	180,00 €	
AFMRC-RD1604-D066-A22-Z05-H	66	5	22	50	8	FOR ISO INSERT.	180,00 €	
AFMRC-RD1604-D066-A27-Z05-H	66	5	27	50	8		180,00 €	
AFMRC-RD1604-D080-A27-Z06-H	80	6	27	50	8		225,00 €	
AFMRC-RD1604-D100-A32-Z07-H	100	7	32	50	8		256,00 €	
AFMRC-RD1604-D125-B40-Z07	125	7	40	63	8		334,00 €	
AFMRC-RD1604-D160-C40-Z08	160	8	40	63	8		444,00 €	

C SYSTEM FACE MILLING TOOLS / C SYSTEM PLAN UND ECKMESSERKÖPFE

	CODE / TYP	TOOL DIMENSIONS (mm) <small>MAß</small>					CUTTING INSERT WENDE PLATTE	PRICE / PREIS
		DC	ZEFP	DCON	LF	APMX		
	AFM43C-OF07-D063-A22-Z04	63	4	22	40	5		169,00 €
	AFM43C-OF07-D080-A27-Z05	80	5	27	50	5	OF.. 0704..	196,00 €
	AFM43C-OF07-D100-A32-Z06	100	6	32	50	5	FOR ISO INSERT.	252,00 €
	AFM43C-OF07-D125-B40-Z08	125	8	40	63	5		358,00 €
	AFM43C-OF07-D160-C40-Z09	160	9	40	63	5		441,00 €

C SYSTEM FACE MILLING TOOLS / C SYSTEM PLAN UND ECKMESSERKÖPFE

	CODE / TYP	TOOL DIMENSIONS (mm) <small>MAB</small>					CUTTING INSERT WENDE PLATTE	PRICE / PREIS
		DC	ZEFP	DCON	LF	APMX		
 45°	AFM45C-HN0905-D063-A22-Z07	63	7	22	40	4.5		192,00 €
	AFM45C-HN0905-D080-A27-Z09	80	9	27	50	4.5	HN.. 0905..	225,00 €
	AFM45C-HN0905-D100-A32-Z11	100	11	32	50	4.5	FOR WDA-KNMTL	256,00 €
	AFM45C-HN0905-D125-B40-Z13	125	13	40	63	4.5	INSERT.	314,00 €
	AFM45CL-HN0905-D125-B40-Z10	125	10	40	63	4.5		314,00 €
	AFM45C-HN0905-D160-C40-Z15	160	15	40	63	4.5		448,00 €
 45°	AFM45C-XN0806-D063-A22-Z05	63	5	22	50	4.5		168,00 €
	AFM45C-XN0806-D080-A27-Z06	80	6	27	50	4.5	XNMU 0806..	185,00 €
	AFM45C-XN0806-D100-A32-Z08	100	8	32	50	4.5	FOR DJT	221,00 €
	AFM45C-XN0806-D125-B40-Z08	125	8	40	63	4.5	INSERT.	263,00 €
	AFM45C-XN0806-D160-C40-Z10	160	10	40	63	4.5		396,00 €
	AFM45C-XN0806-D200-C60-Z12	200	12	60	63	4.5		571,00 €
 75°	AFM75C-SP12-D050-A22-Z04	50	4	22	42	8		131,00 €
	AFM75C-SP12-D063-A22-Z05	63	5	22	40	8		151,00 €
	AFM75C-SP12-D080-A27-Z06	80	6	27	50	8		180,00 €
	AFM75C-SP12-D100-A32-Z07	100	7	32	50	8	SPKN 1203..	215,00 €
	AFM75C-SP12-D125-B40-Z08	125	8	40	63	8	FOR ISO INSERT.	287,00 €
	AFM75C-SP12-D160-C40-Z09	160	9	40	63	8		358,00 €
	AFM75C-SP12-D200-C60-Z12	200	12	60	63	8		507,00 €
 88°	AFM88C-SN1204-D050-A22-Z05	50	5	22	40	11		193,00 €
	AFM88C-SN1204-D063-A22-Z06	63	6	22	40	11	SN.. 1204..	240,00 €
	AFM88C-SN1204-D080-A27-Z07	80	7	27	50	11	FOR UNIN-NT.-KYCR	319,00 €
	AFM88C-SN1204-D100-A32-Z08	100	8	32	50	11	INSERT.	350,00 €
	AFM88C-SN1204-D125-B40-Z11	125	11	40	63	11		522,00 €
 90°	AFM90C-TP16-D050-A22-Z04	50	4	22	40	12		131,00 €
	AFM90C-TP16-D063-A22-Z06	63	6	22	45	12		151,00 €
	AFM90C-TP16-D080-A27-Z07	80	7	27	50	12	TP.. 1603..	180,00 €
	AFM90C-TP16-D100-A32-Z08	100	8	32	50	12	FOR ISO INSERT.	215,00 €
	AFM90C-TP16-D125-B40-Z08	125	8	40	63	12		287,00 €
	AFM90C-TP22-D063-A22-Z05	63	5	22	45	18		151,00 €
	AFM90C-TP22-D080-A27-Z06	80	6	27	50	18		180,00 €
	AFM90C-TP22-D100-A32-Z07	100	7	32	50	18	TP.. 2204..	215,00 €
	AFM90C-TP22-D125-B40-Z08	125	8	40	63	18	FOR ISO INSERT.	287,00 €
	AFM90C-TP22-D160-C40-Z09	160	9	40	63	18		358,00 €
	AFM90C-TP22-D200-C60-Z12	200	12	60	63	18		507,00 €
	AFM90C-TP22-D250-C60-Z15	250	15	60	63	18		714,00 €
	AFM90C-TP22-D315-D60-Z18	315	18	60	63	18		1.155,00 €

HIGH FEED MILLING TOOLS / HOCHVORSCHUBFRÄSER

	CODE / TYP	TOOL DIMENSIONS (mm) <small>MAß</small>					CUTTING INSERT <small>WENDE PLATTE</small>	PRICE / PREIS
		DCX	ZEFP	DCON	LF	APMX		
	AHFM-BL0603-D040-A16-Z06-H	40	6	16	40	1	BLMP 0603..	146,00 €
	AHFM-BL0603-D050-A22-Z07-H	50	7	22	40	1		178,00 €
	AHFM-BL0904-D040-A16-Z05-H	40	5	16	40	2	BLMP 0904..	128,00 €
	AHFM-BL0904-D050-A22-Z06-H	50	6	22	50	2	FOR TGTC	146,00 €
	AHFM-BL0904-D063-A22-Z05-H	63	5	22	50	2	INSERT.	184,00 €
	AHFM-BL0904-D063-A22-Z07-H	63	7	22	50	2		251,00 €
	AHFM-BL1205-D050-A22-Z03-H	50	3	22	40	2	BLMP 1205..	245,00 €
	AHFM-BL1205-D063-A22-Z04-H	63	4	22	40	2	FOR TGTC	276,00 €
	AHFM-BL1205-D080-A27-Z05-H	80	5	27	50	2	INSERT.	326,00 €
	AHFM-EN1004-D050-A22-Z05-H	50	5	22	50	1	ENMU 1004..	157,00 €
	AHFM-EN1004-D050-A22-Z06-H	50	6	22	50	1	FOR DJT	172,00 €
	AHFM-EN1004-D052-A22-Z06-H	52	6	22	50	1	INSERT.	172,00 €
	AHFM-EN1004-D063-A22-Z06-H	63	6	22	50	1		182,00 €
	AHFM-EP1003-D050-A22-Z08-H	50	8	22	40	1	EP.. 1003..	199,00 €
	AHFM-EP1003-D063-A22-Z08-H	63	8	22	40	1	ZPMT 1003..	210,00 €
							YPHW 1003.. FOR DJT INSERT.	
	AHFM-L003-D040-A16-Z06-H	40	6	16	40	1	LOGU 0303..	192,00 €
	AHFM-L003-D050-A22-Z07-H	50	7	22	40	1	FOR KYCR	225,00 €
	AHFM-L003-D063-A22-Z09-H	63	9	22	40	1	INSERT.	279,00 €
	AHFM-LN0303-D040-A16-Z06-H	40	6	16	40	12	LNMU 0303..	173,00 €
	AHFM-LN0303-D050-A22-Z07-H	50	7	22	50	12	FOR TNGLY	202,00 €
	AHFM-LN0303-D063-A22-Z09-H	63	9	22	50	12	INSERT.	251,00 €
	AHFM-JD1003-D040-A16-Z06-H	40	6	16	40	9	JDMT 1003..	223,00 €
	AHFM-JD1003-D063-A22-Z08-H	63	8	22	40	9	FOR MTSBH INSERT.	281,00 €

HIGH FEED MILLING TOOLS / HOCHVORSCHUBFRÄSER

	CODE / TYP	TOOL DIMENSIONS (mm) <small>MAß</small>					CUTTING INSERT <small>WENDE PLATTE</small>	PRICE / PREIS
		DCX	ZEFP	DCON	LF	APMX		
	AHFM-SP0945-D050-A22-Z06-H	50	6	22	40	1.4	SPMX 0945..	183,00 €
	AHFM-SP0945-D052-A22-Z06-H	52	6	22	40	1.4	FOR MTSBH INSERT.	198,00 €
	AHFM-J009-D050-A22-Z04-H	50	4	22	50	1.2	JOMU 0905..	161,00 €
	AHFM-J009-D063-A22-Z05-H	63	5	22	50	1.2	FOR MTSBH INSERT.	189,00 €
	AHFMC-JD1204-D052-A22-Z03-H	52	3	22	50	1.5		180,00 €
	AHFMC-JD1204-D052-A22-Z04-H	52	4	22	50	1.5	JDMW 1204..	202,00 €
	AHFMC-JD1204-D063-A22-Z05-H	63	5	22	50	1.5	FOR MTSBH	233,00 €
	AHFMC-JD1204-D080-A27-Z06-H	80	6	27	50	1.5	INSERT.	275,00 €
	AHFMC-JD1204-D100-A32-Z07-H	100	7	32	50	1.5		321,00 €
	AHFMC-JD1405-D052-A22-Z03-H	52	3	22	40	2	JDMW 1405..	202,00 €
	AHFMC-JD1405-D063-A22-Z04-H	63	4	22	40	2	FOR MTSBH INSERT.	239,00 €
	AHFMC-SD1204-D050-A22-Z04-H	50	4	22	40	1.8	SD.. 1204..	178,00 €
	AHFMC-SD1204-D063-A22-Z05-H	63	5	22	40	1.8	FOR ZCC	205,00 €
	AHFMC-SD1204-D080-A27-Z06-H	80	6	27	50	1.8	INSERT.	281,00 €
	AHFMC-SD1204-D100-A32-Z08-H	100	8	32	50	1.8		341,00 €
	AHFM-SD1205-D052-A22-Z04-H	52	4	22	50	2	SD.. 1205..	211,00 €
	AHFM-SD1205-D052-A22-Z05-H	52	5	22	50	2	FOR HTCH	228,00 €
	NEW AHFM-SD1205-D063-A22-Z05-H	63	5	22	50	2	INSERT.	256,00 €
	AHFM-SD1205-D066-A22-Z05-H	66	5	22	50	2		256,00 €
	AHFM-SD1205-D066-A22-Z06-H	66	6	22	50	2		274,00 €
	AHFM-SD1205-D080-A27-Z06-H	80	6	27	70	2		296,00 €
	AHFM-S01004-D050-A22-Z05-H	50	5	22	50	1.5	SOMT 1004..	205,00 €
	AHFM-S01004-D063-A22-Z06-H	63	6	22	50	1.5	FOR KYCR	234,00 €
	AHFM-S01004-D080-A27-Z07-H	80	7	27	63	1.5	INSERT.	290,00 €
	AHFM-SP1004-D050-A22-Z05-H	50	5	22	50	9.4	SPNW 1004..	212,00 €
	AHFM-SP1004-D052-A22-Z05-H	52	5	22	50	9.4	FOR DJT	212,00 €
	AHFM-SP1004-D063-A22-Z06-H	63	6	22	50	9.4	INSERT.	234,00 €

HIGH FEED MILLING TOOLS / HOCHVORSCHUBFRÄSER

	CODE / TYP	TOOL DIMENSIONS (mm) ^{MAS}					CUTTING INSERT WENDE PLATTE	PRICE / PREIS
		DCX	ZEFP	DCON	LF	APMX		
	AHFMC-WD06T3D-D042-A16-Z04-H	42	4	16	45	1.5	WD.W 06T3..	182,00 €
	AHFMC-WD06T3D-D050-A22-Z05-H	50	5	22	50	1.5	FOR DJT	193,00 €
	AHFMC-WD06T3D-D052-A22-Z05-H	52	5	22	50	1.5	INSERT.	197,00 €
	AHFMC-WD0805D-D052-A22-Z04-H	52	4	22	50	2		193,00 €
	AHFMC-WD0805D-D063-A22-Z05-H	63	5	22	50	2	WD.W 0805..	218,00 €
	AHFMC-WD0805D-D063-A27-Z05-H	63	5	27	50	2	FOR DJT	218,00 €
	AHFMC-WD0805D-D066-A27-Z05-H	66	5	27	50	2	INSERT.	233,00 €
	AHFMC-WD0805D-D080-A27-Z05	80	5	27	50	2		262,00 €
	AHFMC-WD0805D-D100-A32-Z06	100	6	32	50	2		334,00 €
	AHFMC-WD10X6D-D125-B40-Z06	125	6	40	63	2.5	WD.W 10X6..	368,00 €
AHFMC-WD10X6D-D160-C40-Z07	160	7	40	63	2.5	FOR DJT	459,00 €	
						INSERT.		
	AHFMC-WD0804-D040-A16-Z04-H	40	4	16	40	-	WDMT 0804..	194,00 €
	AHFMC-WD0804-D050-A22-Z04-H	50	4	22	50	-	FOR SMTM INSERT.	215,00 €
	AHFMC-WD1205-D050-A22-Z04-H	50	4	22	50	-	WDMT 1205..	199,00 €
	AHFMC-WD1205-D052-A22-Z04-H	52	4	22	50	-	FOR SMTM	199,00 €
	AHFMC-WD1205-D063-A22-Z05-H	63	5	22	50	-	INSERT.	234,00 €
	AHFMC-WD1205-D080-A27-Z06-H	80	6	27	63	-		270,00 €
	AHFM-WN0907-D050-A22-Z04-H	50	4	22	50	3	WNMU 0907..	214,00 €
	AHFM-WN0907-D052-A22-Z04-H	52	4	22	50	3	FOR DJT	214,00 €
	AHFM-WN0907-D063-A22-Z05-H	63	5	22	50	3	INSERT.	231,00 €
	AHFM-WN0907-D066-A27-Z05-H	66	5	27	50	3		245,00 €
	AHFM-WN0907-D080-A27-Z06-H	80	6	27	50	3		305,00 €
	AHFM-WN0907-D100-A32-Z07-H	100	7	32	50	3		368,00 €
	AHFM-WN09T3-D040-A16-Z04-H	40	4	16	40	1.5		186,00 €
	AHFML-WN09T3-D040-A16-Z04-H	40	4	16	40	1.5	WNMX 09T3..	186,00 €
	AHFM-WN09T3-D050-A22-Z05-H	50	5	22	40	1.5	FOR KRLY	224,00 €
	AHFML-WN09T3-D050-A22-Z05-H	50	5	22	40	1.5	INSERT.	224,00 €
	AHFM-WN09T3-D063-A22-Z06-H	63	6	22	40	1.5		252,00 €

T - SLOT MILLING / T - NUTENFRÄSER

	CODE / TYP	ZEFP		TOOL DIMENSIONS (mm) MAB						CUTTING INSERT WENDE PLATTE	PRICE / PREIS
		TOPLAM	ETKILI	DC	CW	DCON	LF	DN	LH		
	ATSM90-CC06-D17X8-W16-L85-Z02	2	1	17	8	16	85	10	16		120,00 €
	NEW ATSM90-CC06-D22X8-W20-L83-Z04	4	2	22	8	20	83	9	38		157,00 €
	ATSM90-CC06-D28X8-W20-L66-Z04	4	2	32	8	25	100	16	23		185,00 €
	ATSM90-CC06-D32X8-W25-L100-Z04	4	2	28	8	20	66	14	15.5		158,00 €
	ATSM90-CC06-D45.5X8-W25-L100-Z06	6	3	45.5	8	25	100	12	30		281,00 €
	ATSM90-CC06-D63X8-W32-L125-Z08	8	4	63	8	32	125	31.5	30	CC.. 0602..	263,00 €
	ATSM90-CC06-D18X9-W16-L90-Z02	2	1	18	9	16	90	10	16	FOR ISO	120,00 €
	ATSM90-CC06-D20X9-W16-L85-Z04	4	2	20	9	16	85	10	16	INSERT.	152,00 €
	ATSM90-CC06-D23X10-W20-L90-Z04	4	2	23	10	20	90	12	25		157,00 €
	ATSM90-CC06-D32X10-W25-L100-Z04	4	2	32	10	25	100	16	25		158,00 €
	ATSM90-CC06-D45X10-W32-L120-Z06	6	3	45	10	32	120	20	25		198,00 €
	ATSM90-CC06-D25X11-W25-L100-Z04	4	2	25	11	25	100	13	20		157,00 €
	ATSM90-CC09-D30X12-W25-L100-Z04	4	2	30	12	25	100	16	25		171,00 €
	ATSM90-CC09-D32X12-W25-L100-Z02	2	1	32	12	25	100	16	25	CC.. 09T3..	169,00 €
	ATSM90-CC09-D32X12-W25-L100-Z04	4	2	32	12	25	100	16	25	FOR ISO	183,00 €
	ATSM90-CC09-D32X14-W25-L100-Z04	4	2	32	14	25	100	16	25	INSERT.	183,00 €
	ATSM90-CC09-D37X16-W32-L120-Z04	4	2	37	16	32	120	17	30		172,00 €
	ATSM90-CC09-D42X17-W32-L120-Z04	4	2	42	17	32	120	19	30		184,00 €
	ATSM90-CC09-D40X17-W32-L120-Z04-H	4	2	40	17	32	120	19	30		184,00 €
	ATSM90-CC12-D47X20-W32-L120-Z04	4	2	47	20	32	120	25	45	CC.. 1204..	198,00 €
ATSM90-CC12-D52X21-W32-L120-Z04	4	2	52	21	32	120	25	45	FOR ISO	225,00 €	
ATSM90-CC12-D50X22-W32-L120-Z04	4	2	50	22	32	120	25	45	INSERT.	211,00 €	
ATSM90-CC12-D55X22-W32-L120-Z04	4	2	55	22	32	120	25	45		237,00 €	
	ATSM90-SP.05-D22.5X5-W25-L100-Z04	4	2	22.5	5	25	100	12	25	SPMG 050204	202,00 €
	NEW ATSM90-SP.05-D25X5-W25-L100-Z04	4	2	25	5	25	100	9	25	FOR TGTC INSERT.	157,00 €
	ATSM90-SP.05-D30X5-W25-L100-Z04	4	2	30	5	25	100	10	25		287,00 €
	ATSM90-SPGT0502-D63X6-W32-L125-Z10	10	5	63	6	32	125	31	30	SPGT 050204	316,00 €
	ATSM90-SPGT0904-D32X14-W32-L120-Z04-H	4	2	32	14	32	120	17.5	30	SPGT 090408	172,00 €
	ATSM90-SPGT0904-D37X16-W32-L120-Z04-H	4	2	37	16	32	120	21	40	FOR ZCC INSERT.	172,00 €
	ATSM90-SPGT0904-D42X17-W32-L120-Z04-H	4	2	42	17	32	120	21	40		184,00 €
	ATSM90-SPGT1104-D47X20-W32-L120-Z04-H	4	2	47	20	32	120	24	45	SPGT 110408	198,00 €
	ATSM90-SP.06-D80X7-W32-L120-Z10	10	5	80	7	32	120	32	30	SPMG 060204 TGTC	775,00 €
	ATSMR-RD0702-D17-W16-L90-Z02	2	17	7	16	90	10	12	RD.. 0702..	151,00 €	
	ATSMR-RD0702-D25-W16-L90-Z03	3	25	7	16	90	15	12	FOR ISO	173,00 €	
	ATSMR-RD0702-D35-W25-L100-Z05	5	35	7	25	100	20	20	INSERT.	210,00 €	
	ATSMR-RD1003-D21-W25-L100-Z02	2	21	10	25	100	12	20	RD.. 1003..	156,00 €	
	ATSMR-RD1003-D80-W32-L165-Z06-H	6	80	10	32	165	30	31.5		857,00 €	
	ATSMR-RD12T3-D25-W25-L100-Z02	2	25	12	25	100	15	24	RD.. 12T3..	162,00 €	
	ATSMR-RD12T3-D80-W32-L165-Z06-H	6	80	12	32	165	30	31.5		857,00 €	
	ATSMR-RD1604-D34-W32-L110-Z02	2	34	16	32	110	20	30	RD.. 1604..	168,00 €	
									FOR ISO		
									INSERT.		



Cutting Calculation : P 166 / Schnittdatenberechnung : S 166

User's Guide For T Slot Milling Tools : P 147 / Benutzerhinweise für T-Nutenfräser : S 147

Ordering Example/Beispiel Bestellformular: 1pcs. ATSM90-CC06-D17X8-W16-L85-Z02

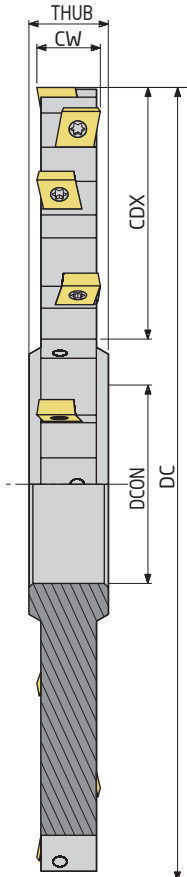

SLOT DISC MILLING / SCHEIBENFRÄSER

	CODE / TYP	ZEFP		TOOL DIMENSIONS (mm) <small>MAß</small>					CUTTING INSERT <small>WENDE PLATTE</small>	PRICE / PREIS
		TOPLAM	ETKİLİ	DC	CW	CDX	DCON	THUB		
	ASDM-SPGT05-D80x6-d27-Z10	10	5	80	6	17	27	10	SPGT 0502..	223,00 €
	ASDM-SPGT05-D100x6-d32-Z12	12	6	100	6	25	32	10	FOR ZCC	261,00 €
	ASDM-SPGT05-D125x6-d40-Z14	14	7	125	6	35	40	10	INSERT.	394,00 €
	ASDM-SPGT05-D160x6-d40-Z18	18	9	160	6	52	40	10		523,00 €
	ASDM-SPGT06-D80x7-d27-Z10	10	5	80	7	17	27	11		223,00 €
	ASDM-SPGT06-D100x7-d32-Z12	12	6	100	7	25	32	11	SPGT 0602..	261,00 €
	ASDM-SPGT06-D125x7-d40-Z14	14	7	125	7	35	40	11	FOR ZCC	394,00 €
	ASDM-SPGT06-D160x7-d40-Z16	16	8	160	7	52	40	11	INSERT.	523,00 €
	ASDM-SPGT06-D200x7-d40-Z18	18	9	200	7	70	40	11		654,00 €
	ASDM-SPGT07-D100x10-d27-Z10	10	5	100	10	26.5	27	17	SPGT 07T308	261,00 €
ASDM-SPGT07-D100x10-d32-Z12	12	6	100	10	25	32	11	FOR ZCC INSERT.	261,00 €	
 	ASDM-CC06-D80x8-d27-Z10	10	5	80	8	17	27	12		223,00 €
	ASDM-CC06-D100x8-d32-Z12	12	6	100	8	25	32	12		261,00 €
	ASDM-CC06-D125x8-d40-Z14	14	7	125	8	35	40	12		394,00 €
	ASDM-CC06-D160x8-d40-Z16	16	8	160	8	52	40	12		523,00 €
	ASDM-CC06-D200x8-d40-Z18	18	9	200	8	70	40	12	CC.. 0602..	654,00 €
	ASDM-CC06-D80x10-d27-Z10	10	5	80	10	17	27	14	FOR ISO	223,00 €
	ASDM-CC06-D100x10-d32-Z12	12	6	100	10	25	32	14	INSERT.	261,00 €
	ASDM-CC06-D125x10-d40-Z14	14	7	125	10	35	40	14		394,00 €
	ASDM-CC06-D160x10-d40-Z16	16	8	160	10	52	40	14		523,00 €
	ASDM-CC06-D200x10-d40-Z18	18	9	200	10	70	40	14		654,00 €
	ASDM-CC09-D80x12-d27-Z08	8	4	80	12	17	27	16		223,00 €
	ASDM-CC09-D100x12-d32-Z10	10	5	100	12	25	32	16		261,00 €
	ASDM-CC09-D125x12-d40-Z12	12	6	125	12	35	40	16		394,00 €
	ASDM-CC09-D160x12-d40-Z14	14	7	160	12	52	40	16		523,00 €
	ASDM-CC09-D200x12-d40-Z16	16	8	200	12	70	40	16		654,00 €
	ASDM-CC09-D80x14-d27-Z08	8	4	80	14	17	27	18	CC.. 09T3..	223,00 €
	ASDM-CC09-D100x14-d32-Z10	10	5	100	14	25	32	18	FOR ISO	261,00 €
	ASDM-CC09-D125x14-d40-Z12	12	6	125	14	35	40	18	INSERT.	394,00 €
	ASDM-CC09-D160x14-d40-Z14	14	7	160	14	52	40	18		523,00 €
	ASDM-CC09-D200x14-d40-Z16	16	8	200	14	70	40	18		654,00 €
	ASDM-CC12-D80x16-d27-Z06	6	3	80	16	17	27	20		223,00 €
	ASDM-CC12-D100x16-d32-Z08	8	4	100	16	25	32	20		261,00 €
	ASDM-CC12-D125x16-d40-Z10	10	5	125	16	35	40	20		394,00 €
	ASDM-CC12-D160x16-d40-Z12	12	6	160	16	52	40	20		523,00 €
	ASDM-CC12-D200x16-d40-Z14	14	7	200	16	70	40	20		654,00 €
	ASDM-CC12-D80x18-d27-Z06	6	3	80	18	17	27	22		223,00 €
	ASDM-CC12-D100x18-d32-Z08	8	4	100	18	25	32	22		261,00 €
	ASDM-CC12-D125x18-d40-Z10	10	5	125	18	35	40	22		394,00 €
	ASDM-CC12-D160x18-d40-Z12	12	6	160	18	52	40	22		523,00 €
	ASDM-CC12-D200x18-d40-Z14	14	7	200	18	70	40	22	CC.. 1204..	654,00 €
	ASDM-CC12-D250x18-d40-Z16	16	8	250	18	90	40	22	FOR ISO INSERT.	915,00 €
	ASDM-CC12-D80x20-d27-Z06	6	3	80	20	17	27	24		223,00 €
ASDM-CC12-D100x20-d32-Z08	8	4	100	20	25	32	24		261,00 €	
ASDM-CC12-D125x20-d40-Z10	10	5	125	20	35	40	24		394,00 €	
ASDM-CC12-D160x20-d40-Z12	12	6	160	20	52	40	24		523,00 €	
ASDM-CC12-D200x20-d40-Z14	14	7	200	20	70	40	24		654,00 €	
ASDM-CC12-D250x20-d40-Z16	16	8	250	20	90	40	24		915,00 €	

TECHNICAL INFORMATION

User's Guide For AKKO U-Drills

Before connecting your U-Drill to CNC lathe, you have to check if the turret is eccentric from the center or not. If there is any eccentricity in your turret, never use your U-Drill;

Processes that should be done to fix the turret :

1. A cylindrical part whose surface is precision and whose length and diameter is the same with the U-Drill that you will use, should be mounted to the holder of turret and X value of the lathe should be brought to zero (0).
2. Comparator should be mounted to chuck. The end of the comparator should be contacted (touched) to the surface of the part that we mounted on the turret.
3. The comparator that we mounted on the chuck should be turned 360-degree with the chuck and turret should be zeroed by that turning according to changing rate of comparator.

Cutting Speed and Revolution That are Needed For Using (Running) Your U-DRILLS More Productively

Grup No.	Material	Material Type	Cutting Speed Vc (m/m)
1	Non-alloy steel and free cutting steel	C1010. Automat etc.	220
2	Low alloy steel and cast steel	C1030 - 106 etc.	200
3	Alloy steel and tool steel	CK-45, 4140, 7131 etc.	170
4	Hot Work Steel and Stainless Steel	Impax etc.	150

P.S. : The cutting speed may be concerned with the type of the insert that you use.
 Firstly, choose the material to make calculation of revolution. You should multiply the cutting speed (Vc) of the material that you chose by 1000 and divide by 3.14. You should divide the value that you found by the diameter of U-Drill. For Example : If our material is alloy steel and tool steel (3rd group), diameter of the U-Drill is 25 mm, cutting speed is 170, we should calculate as following; $170 \times 1000 / 3.14 = 54140$, $54140 / 25 = 2166$ rpm is the result that we found (Spindle Speed) Feed rate of the lathe is concerned with the U-Drill that you will use and changes between 0.05 and 0.10. The user sets it according to cut of cutting insert.

Feed Calculation For Central Machine :

2166 spindle speed, that we found as a result of above mentioned calculation, should be multiplied by cutting insert feed (mm/r) between 0.05 and 0.10 feed choisses. Example 1 : $2166 \times 0.05 = 108$
 Example 2 : $2116 \times 0.10 = 217$ The results 108 and 217 are the feed mm/m calculation for central machine.
 Note: Cooling water pressure of lathe must be minimum 6 bar for our D4 u-drills and u-drills longer than D4.

Calculating Spindle Speed and Feed Rate For Milling Process

Vc.	S	D	F	Z	fz	FORMULAS
Cutting Speed (Please read from the back-side of cutting insert box)	Spindle Revolution rpm	Milling Tool Diameter	Feed Rate	Number of Effective Tooth	Feed Per Tooth (Please Read From The Back Side of Cutting Insert Box)	Calculation of Revolution : $S = (Vc \times 1000) / (3,14 \times D)$ Feed Rate Calculation : $F = S \times Z \times fz$

For Example : We will make milling with milling tool whose diamention is D 50 mm, whose theeth number is Z=5. The spindle revolution was written as Vc=200m/mn at the back side of cutting insert box. Let's calculate the revolution that should be entered to the milling machine : Vc=200 m/mn D=50 mm
 $S =$ Firstly Cutting Speed is multiplied with 1000, the result should be divided by 3.14 , the last result should be divided by diameter of milling tool.
 $S = 200 \times 1000 = 200000 \rightarrow 200000 / 3,14 = 63663 \rightarrow 63663 / 50 = 1273$ rev $S = 1273$ rev / mn
 After finding spindle revolution, let's find feed rate : milling tool with Z=5 teeth and we read fz=0,12 from the back side of cutting insert box.
 $F =$ Tooth number should be multiplied with revolution, the result should be multiplied with feed per tooth.
 $F = 1273 \times 5 = 6365 \rightarrow 6365 \times 0,12 = 763$ $F = 763$ mm / mn
 Revolution that should be entered to the milling machine = S 1273 Feed Rate that should be entered to the milling machine = F 763 average value.
 P.S : The values Vc and fz has to be written at the back side of the cutting insert. If these values were not written on the cutting insert box, please find them from cutting insert catalogue. If the material that you will work is steel, please read Vc and fz values that were written on the part P, if it is stainless steel please read from the part M, if it is cast iron please read from the part K.

TECHNICAL INFORMATION

Recommended Tightening Torque

- Read below information before tightening the tool.
- Check screw set's the screw size and together with mounting arbor inner dimension of screws.
- When tightening head to an arbor, follow the related tightening torque in the table.

Screw	Torque (N.m)
M6	8
M8	23
M10	46
M12	80
M16	90

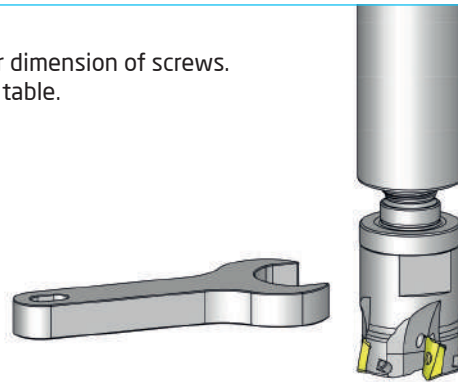

Internal Boring Bars Application Guide, Related to Body Material

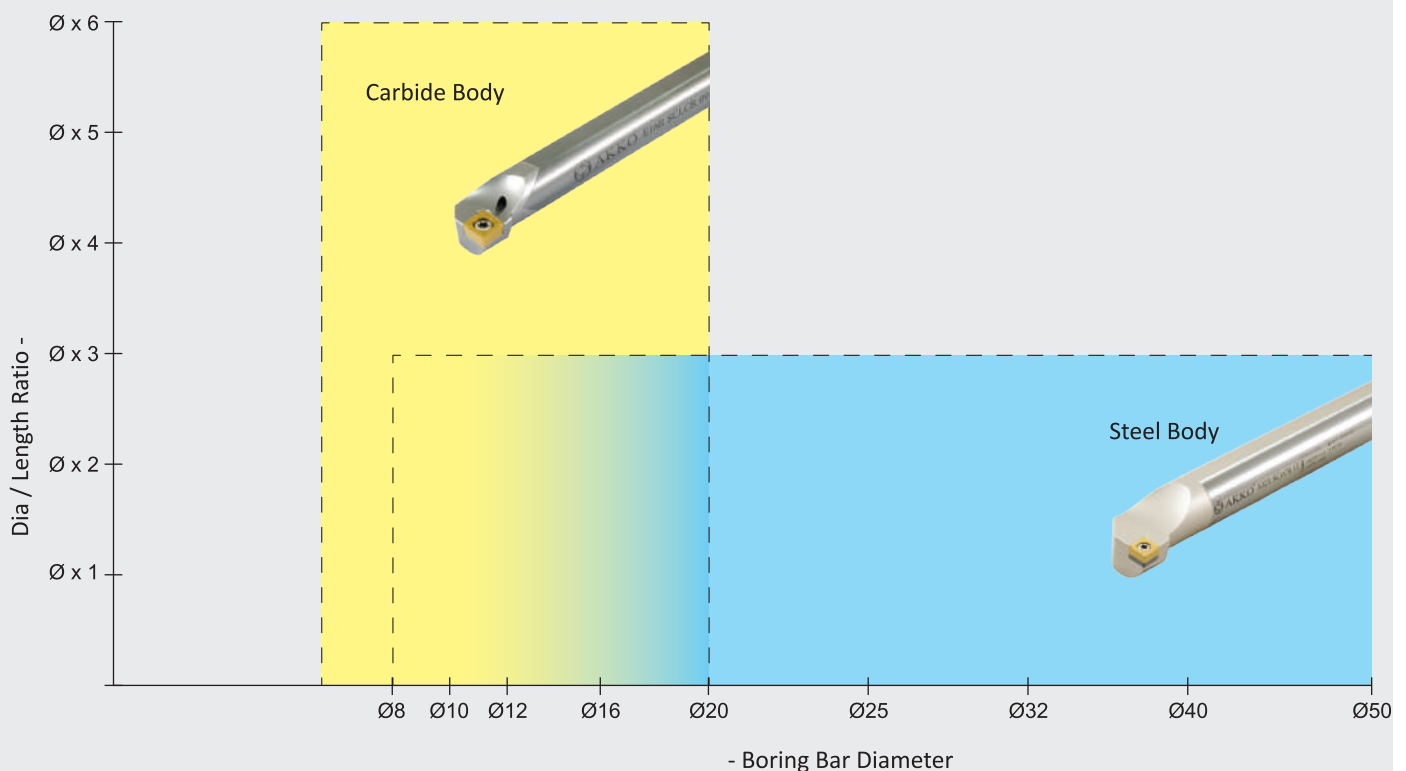

Application Guide For T-Slot Milling

When T slot machining steel, the workpiece must be machined as shown in the drawing to ensure smooth chip evacuation.

Example: Before slotting with the T - slot milling cutter - code ATSM90-CC06-D32X10-W25-L100-Z04,







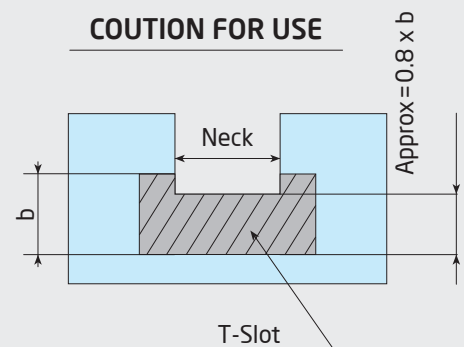

















The area of the neck of the tools to be worked and must be machined by End-Mill. In this case, it is very wrong to machining the slot completely. Bottom area (0.8 x b = 0.8 x 10) should be left 8 mm without machining. This area's operation must be machined by the T- slot milling cutter which is also necessary for the healthier work of the tool holder.

Slots to be machined must be free from chips for smooth machining.

CAUTION FOR USE



SPARE PARTS / ERSATZTEILE
SHIMS

PRODUCT PICTURE	CODE	PRODUCT DETAIL		PRICE / PREIS
	AATN-2-0001	S-SYSTEM	TCMT 16 SHIM	6,50 €
	AATN-2-0002	T-M SYSTEM	TNMG 16 SHIM	6,50 €
	AATN-3-0025	C-SYSTEM	TNGN 16 SHIM	
	AATN-3-0015	P-SYSTEM	TNMG 16 SHIM	6,50 €
	AATN-2-0020	T-M-P SYSTEM	TNMG 22 SHIM	6,80 €
	AATN-2-0004	For THREADING 16 SHIM		6,80 €
	AATN-2-0004	For THREADING 22 SHIM		8,50 €
	ATS-16E	For THREADING 16, EXTERNAL RIGHT - INTERNAL LEFT SHIM		9,60 €
	ATS-16I	For THREADING 16, EXTERNAL LEFT - INTERNAL RIGHT SHIM		9,60 €
	ATS-22E	For THREADING 22, EXTERNAL RIGHT - INTERNAL LEFT SHIM		13,10 €
	ATS-22I	For THREADING 22, EXTERNAL LEFT - INTERNAL RIGHT SHIM		13,10 €
	ATS-27E	For THREADING 27, EXTERNAL RIGHT - INTERNAL LEFT SHIM		24,40 €
	ATS-27I	For THREADING 27, EXTERNAL LEFT - INTERNAL RIGHT SHIM		24,40 €
		AACN-2-0001	S-SYSTEM	CCMT 09 SHIM
AACN-2-0002		T-SYSTEM	CNMG 09 SHIM	
	AACN-2-0002	P-SYSTEM	CNMG 09 SHIM	6,50 €
	AACN-2-0003	S-SYSTEM	CCMT 12 SHIM	6,80 €
	AACN-3-0001	T-M-P SYSTEM	CNMG 12 SHIM	6,80 €
	AACN-3-0001	C-SYSTEM	CNGN 12 SHIM	
	AACN-3-0002	T-P SYSTEM	CNMG 16 SHIM	9,30 €
	AACN-3-0003	T-P SYSTEM	CNMG 19 SHIM	15,30 €
	AACN-3-0008	T-P SYSTEM	CNMG 25 SHIM	24,40 €
	AAWN-2-0003	T-M-P SYSTEM	WNMG 08 KALIN ALTLIK	9,30 €
	AAWN-3-0001	T-M-P SYSTEM	WNMG 08 SHIM	6,80 €
	AAWN-SW317	T-M-P SYSTEM	WNMG 06 SHIM	6,50 €
	AKS-16L	C-SYSTEM	KNUX-L 16 SHIM	6,80 €
	AKS-16R	C-SYSTEM	KNUX-R 16 SHIM	6,80 €
	AASD-3-0001	S-SYSTEM MILLING	SDMT 12 SHIM	9,30 €
	AASE-3-0001	S-SYSTEM MILLING	SEMT 13 SHIM	9,30 €
	AASN-2-0001	S-SYSTEM	SCMT 09 SHIM	6,50 €
	AASN-2-0002	P-SYSTEM	SNMG 09 SHIM	6,50 €
	AASN-2-0004	S-SYSTEM	SCMT 12 SHIM	6,80 €
	AASN-3-0004	T-P SYSTEM	SNMG 12 SHIM	6,80 €
	AASN-3-0004	C-SYSTEM	SNGN 12 SHIM	
	AASN-3-0023	T-P SYSTEM	SNMG 15 SHIM	9,30 €
	AASN-3-0005	T-P SYSTEM	SNMG 19 SHIM	15,30 €
	AASN-3-0020	T-P SYSTEM	SNMG 25 SHIM	24,40 €
	AASN-20020	PSDNN	SNMG 12 SHIM	12,30 €
		AADN-2-0001	S-SYSTEM	DCMT 11 SHIM
AADN-2-0001		T-SYSTEM	DNMG 11 SHIM	
	AADN-SD317	P-SYSTEM	DNMG 11 SHIM	6,50 €
	AADN-3-0001	T-M-P SYSTEM	DNMG 15 SHIM	6,80 €
	AADN-3-0001	C-SYSTEM	DNGN 15 SHIM	
	AADN-2-0003	T-SYSTEM	DNMG 15 THICK SHIM	9,30 €
	AAVN-2-0002	S-SYSTEM	VCMT 22, VCMT 22 SHIM	6,80 €
	AAVN-2-0002	T-SYSTEM	VNMG 16 SHIM	
	AAVN-2-0003	S-SYSTEM	VCMT 22, VCMT 22 SHIM	9,30 €
	AARC-3-0001	for C-SYSTEM	RCGX 06 SHIM	15,80 €
	AARC-3-0002	for C-SYSTEM	RCGX 09 SHIM	15,80 €
	AARC-3-0003	for C-SYSTEM	RCGX 12 SHIM	15,80 €
	AARC-3-0005	for C-SYSTEM	RCGX 06 SHIM	35,10 €
	AARC-3-0006	for C-SYSTEM	RCGX 09 SHIM	35,10 €
	AARC-3-0007	for C-SYSTEM	RCGX 12 SHIM	35,10 €

SPARE PARTS / ERSATZTEILE

CLAMPS

PRODUCT PICTURE	CODE	PRODUCT DETAIL		PRICE / PREIS
	ATK-01	for T-SYSTEM	DNMG 11, WNMG 06, TNMG 16, CNMG 09 CLAMP	8,00 €
	ATK-02	for T-SYSTEM	CNMG 12, WNMG 08, TNMG 22, DNMG 15, SNMG 12 CLAMP	8,00 €
	ATK-03	for T-SYSTEM	VNMG 16 CLAMP	8,00 €
	ATK-04	for T-SYSTEM	CNMG 16, SNMG 15 CLAMP	8,00 €
	ATKH-01-R	for T-SYSTEM	WITH COOLANT TOOLS CLAMP	52,40 €
	ATKH-02-L	for T-SYSTEM	WITH COOLANT TOOLS CLAMP	52,40 €
	ATKH-03-R	for T-SYSTEM	WITH COOLANT TOOLS CLAMP	52,40 €
	ATKH-04-L	for T-SYSTEM	WITH COOLANT TOOLS CLAMP	52,40 €
	ATKH-05-R	for T-SYSTEM	WITH COOLANT TOOLS CLAMP	52,40 €
	ATKH-06-L	for T-SYSTEM	WITH COOLANT TOOLS CLAMP	52,40 €
	ATKH-07-R	for T-SYSTEM	WITH COOLANT TOOLS CLAMP	52,40 €
	ATKH-08-L	for T-SYSTEM	WITH COOLANT TOOLS CLAMP	52,40 €
	ATKH-09-R	for T-SYSTEM	WITH COOLANT TOOLS CLAMP	52,40 €
	ATKH-10-L	for T-SYSTEM	WITH COOLANT TOOLS CLAMP	52,40 €
	AMK-01	for M-SYSTEM	WNMG 06 CLAMP	8,00 €
	AMK-02	for M-SYSTEM	INTERNAL Ø20 TNMG 16 Ø25 MT-NR/L 16 CLAMP	8,00 €
	AMK-03	for M-SYSTEM	DNMG 11, CNMG 12 CLAMP	8,00 €
	AMK-04	for M-SYSTEM	DNMG 15, TNMG 16-22 CLAMP	8,00 €
	AMK-05	for M-SYSTEM	WNMG 08 CLAMP	8,00 €
	AMK-07	for M-SYSTEM	S20R MCLNR/L CLAMP	8,00 €
	AMK-08	for M-SYSTEM	TNMG 16-22 CLAMP	8,00 €
	ACK-01-R	for C-SYSTEM	KNUX-R CLAMP	8,00 €
	ACK-02-L	for C-SYSTEM	KNUX-L CLAMP	8,00 €

SPARE PARTS / ERSATZTEILE

CLAMPS

PRODUCT PICTURE	CODE	PRODUCT DETAIL		PRICE / PREIS
	ACK-03	for C-SYSTEM	154.91 EXTERNAL and INTERNAL Ø25-Ø32 CLAMP	8,00 €
	ACK-04	for P-C SYSTEM	CTFPR CARTRIDGE CLAMP	8,00 €
	ACK-05	for C-SYSTEM	ADDITIONAL LITTLE CLAMP for MILLING and THREADING TOOLS	8,00 €
	ACK-06	for C-SYSTEM	154.91 INTERNAL Ø16-Ø20 CLAMP	8,00 €
	ACK-07	for C-SYSTEM	SPARE PART SET of CNGN, SNGN, DNGN (CLAMP+CLAMP SCREW+RING)	21,30 €
	ACK-08	for C-SYSTEM	SPARE PART SET of TNGN, (CLAMP+CLAMP SCREW+RING)	21,30 €
	ACK-09	for P-SYSTEM	ADDITIONAL BIG CLAMP for CNMG 16-19, SNMG 15-19	8,00 €
	ACK-10	for C-SYSTEM MILLING	SPKN 12 ve Ø50-Ø63 TPKN 16 CLAMP (M8x8)	8,00 €
	ACK-11	for C-SYSTEM MILLING	Ø80-Ø100 TPKN 16-TPKN 22, OFKR 07, HNMX 09 CLAMP (M8x10)	8,00 €
	ACK-12	for C-SYSTEM	CTSPR CATRIDGE CLAMP	8,00 €
	ACK-15	for S-SYSTEM MILLING	RD.. 10-12 CLAMP	8,00 €
	ACK-19	for S-SYSTEM MILLING	WD0805D CLAMP	8,00 €
	ACK-21	for C-SYSTEM	SN.. 1204.. CLAMP	13,10 €
	ACK-23	for C-SYSTEM	SPARE PART SET DNGN 11 (CLAMP+CLAMP SCREW+RING)	14,50 €
	ACK-24	for S-SYSTEM MILLING	XD0806D CLAMP	8,00 €
	ACK-26	for C-SYSTEM MILLING	XNMU 0806..CLAMP	8,00 €
	ACK-27	for C-SYSTEM	RCGX 06 CLAMP	15,80 €
	ACK-28	for C-SYSTEM	RCGX 09 CLAMP	15,80 €
	ACK-29	for C-SYSTEM	RCGX 12 CLAMP	15,80 €
	ACK-42	for C-SYSTEM	RCGX 06 CLAMP	17,30 €
	ACK-43	for C-SYSTEM	RCGX 09 CLAMP	17,30 €
	ACK-44	for C-SYSTEM	RCGX 12 CLAMP	17,30 €
	AKK-04	For GROOVING TOOLHOLDERS	ADKT-H22 - S312 - (0.5-2) CLAMP	15,80 €

SPARE PARTS / ERSATZTEILE

CLAMP SCREWS

PRODUCT PICTURE	CODE	PRODUCT DETAIL		PRICE / PREIS
	AKV-01-M5X22	for T-SYSTEM	DNMG 11, WNMG 06, TNMG 16 CLAMP SCREWS (M5X20)	2,20 €
	AKV-02-M6X22	for T-SYSTEM	CNMG 12, WNMG 08, TNMG 22, DNMG 15, SNMG 12-15 VNMG 16 CLAMP SCREWS (M6X20)	2,20 €
for M-SYSTEM		TNMG 16-22, DNMG 15 CLAMP SCREWS (M6X20)		
	AKV-03-M6X22	for M-SYSTEM	WNMG 08 CLAMP SCREWS (M6X20)	2,20 €
	AKV-04-M5X17	for M-SYSTEM	S20R MT-NR/L 16, S20R-S25S MWLNR/L 06, S25S MDUNR/L 11-EXTERNAL MWLNR 06 (M5X20)	2,20 €
	AKV-05-M6X25	for T-SYSTEM	CNMG 16 OLD CLAMP SCREWS (M6X25)	2,20 €
	AKV-06-M6X20	for C-SYSTEM	KNUX 16 CLAMP SCREWS (M6X20)	2,70 €
	AKV-07-M6X22	for C-SYSTEM	ADKT-154.91, AIKT-154.91-R/L-32 CLAMP SCREWS (M6X20)	2,20 €
	AKV-10-M6X14	for C-SYSTEM	AIKT-154.91-R/L-16, AIKT-154.91-R/L-20, AIKT-154.91-R/L-25 CLAMP SCREWS (M6X15)	2,20 €
	AKV-11-M8X29	for C-SYSTEM	TNGN, CNGN, DNGN, SNGN CLAMP SCREWS (M8X33)	2,70 €
	AAV-05-M6X15	for P-SYSTEM	CNMG 16-19, SNMG 15-19 EXTRA BIG CLAMP SCREWS (M6X15)	2,20 €
	AKV-12-M5X12	for C-SYSTEM	CTSPR CLAMP SCREWS (M5X9)	2,20 €
	AKV-13-M8X1X16	for C-SYSTEM MILLING	SPKN 12 ve Ø63 TPKN 16 CLAMP SCREWS (M8X1X16)	2,70 €
	AKV-14-M8X1X18	for C-SYSTEM MILLING	Ø80-Ø100 TPKN 16 ve Ø63-Ø315 TPKN 22 CLAMP SCREWS (M8X1X18)	2,70 €
	AKV-15-M8X1X20	for C-SYSTEM MILLING	OFKR 07, HNMX 09 SCREWS (M8X1X20)	2,70 €
	AKV-16-M6X16	for C-SYSTEM	CTFPR 13CS 16 CLAMP SCREWS (M6X16)	2,70 €
	AKV-17-M5X15	for M-SYSTEM	S16P MWLNR/L CLAMP SCREWS (M5X18)	2,20 €
	AKV-18-M5X14	for C-SYSTEM MILLING	SN19 CLAMP SCREWS (M5X0.8)	2,20 €
	AKV-19-M7X25	for T-SYSTEM	CNMG 16 CLAMP SCREWS (M7X25)	2,70 €
	AKV-20-M6X19	for M-SYSTEM	S25S MDUNR/L 15 CLAMP SCREWS (M6X19)	2,20 €
	AKV-21-M6X18	for C-SYSTEM	AIKT-154.91-R/L-25 CLAMP SCREWS (M6X18)	2,20 €
	AKV-22-M8X1X14	for C-SYSTEM MILLING	Ø50 TPKN 16 CLAMP SCREWS (M8X1X14)	2,70 €
	AKV-24-M6X1X18	for C-SYSTEM MILLING	SN.. 1204 CLAMP SCREWS	2,70 €

SPARE PARTS / ERSATZTEILE

CLAMP SCREWS

PRODUCT PICTURE	CODE	PRODUCT DETAIL		PRICE / PREIS
	AKV-26-M6X0.75X20	for C-SYSTEM MILLING	XNMU 0806.. CLAMP SCREWS	2,70 €
	AKV-27-M6X20	for M-SYSTEM	S25S MWLNR/L 08 CLAMP SCREW	2,20 €
	AKV-28-M10x1.5x43	WNMU 0907.. Ø50 MOUNTING SCREW	Ø50 WNMU 0907.. CLAMP SCREW	18,40 €
	AKV-29-M6X29	ADKT-H22.. SCREW	ADKT-H22.. SCREW	4,00 €
	AKV-30-M6X22	for T-SYSTEM	WITH COOLANT TOOLS CLAMP SCREW	2,20 €
	AKV-33-M6X22	for T-SYSTEM	WITH COOLANT TOOLS CLAMP SCREW	2,20 €
	AKV-39-M7x21	for T-SYSTEM	WITH COOLANT TOOLS CLAMP SCREW	2,70 €

COOLANT NOZZLE

PRODUCT PICTURE	CODE	PRODUCT DETAIL	PRICE / PREIS
	AN-01	COOLANT NOZZLE	34,60 €

SHIM SCREWS

PRODUCT PICTURE	CODE	PRODUCT DETAIL		PRICE / PREIS
	AAV-01-M3X10	for T-SYSTEM	WNMG 06, KNUX 16 SHIM SCREWS	1,40 €
	AAV-02-M5X12	for T-SYSTEM for C-SYSTEM	CNMG 12, WNMG 08, TNMG 22, DNMG 15, SNMG 12 CNGN 12, SNGN 12, DNGN 15 SHIM SCREWS	1,40 €
	AAV-03-M5X12	for T-SYSTEM for C-SYSTEM	TNMG 16 SHIM SCREWS TNGN 16 SHIM SCREWS	1,40 €
	AAV-04-M5X12	for T-SYSTEM	VNMG 16, DNMG 11, CNMG 09 SHIM SCREWS	1,40 €
	AAV-05-M6x10	for T-SYSTEM	SNM. 1506.. SHIM SCREWS (M6X10)	2,20 €
	AAV-05-M6X15	for T-SYSTEM	CNMG 16 SHIM SCREWS	2,20 €
	AAV-06-M3.5X11	for S-SYSTEM	CCMT 09, DCMT 11, VBMT 16, VCMT 16 TCMT 16, DIŞ VİDA 16 SHIM SCREWS (M3.5 BUKSE SCREWS)	4,00 €
	AAV-07-M4.5X13	for S-SYSTEM	CCMT 12, SCMT 12, DIŞ VİDA 22 SHIM SCREWS (M4.5 BUKSE SCREWS)	4,00 €
	AAV-08-M3.5X8	for S-SYSTEM	(M3.5x8 SMALL BUKSE SCREWS)	4,00 €
	AAV-09-M5X9	for T-SYSTEM	S25S TCLNR/L 09, S25S TDUNR/L 11, S25S TDQNR/L 11 SHIM SCREW	1,40 €
	AAV-10-M4.5X8	for S-SYSTEM	(M4.5x8 SMALL BUKSE SCREWS)	4,00 €
	AAV-11-U5-40X4.5	for S-SYSTEM	For THREADING TOOLHOLDERS 16 ER/L, 16 IR/L SHIM SCREW	2,70 €
	AAV-12-U8-32X5.5	for S-SYSTEM	For THREADING TOOLHOLDERS 22 ER/L, 22 IR/L SHIM SCREW	2,70 €
	AAV-13-M5X8	for T-SYSTEM	S25S TSKNR/L 12, S25S TCLNR/L 12, S25S TWLNR/L 08 SHIM SCREW	1,40 €
	AAV-14-M5X14	for ADCR	ADCR MOUNTING SCREW	1,40 €
	AAV-15-M5X5.7	for S-SYSTEM	For THREADING TOOLHOLDERS 27 ER/L, 27 IR/L SHIM SCREW	2,70 €
AAV-16-M3.5X8	for S-SYSTEM	SEMT 13 SHIM SCREWS	4,00 €	

SPARE PARTS / ERSATZTEILE

PINS

PRODUCT PICTURE	CODE	PRODUCT DETAIL		PRICE / PREIS
	APM-01	for M-SYSTEM	DELİK İÇİ Ø25-Ø32-Ø40 ve DIŞ ÇAP TNMG 16 PINS	2,70 €
	APM-02	for M-SYSTEM	TNMG 22, WNMG 08 PINS	2,70 €
	APM-03	for M-SYSTEM	S20R MTFNR/L 16, S20R MT-NR/L 16, S20R MTUNR/L 16, S20R MTQNR/L 16, S20R MDUNR/L 11PINS	2,70 €
	APM-04	for M-SYSTEM	S32T MCLNR/L 12, DNMG 15, S25S MWLNR/L 08 PINS	2,70 €
	APM-05	for M-SYSTEM	MSYNR 11.5CS 12 for CARTRIDGE SNMG 12 PINS	5,30 €
	APM-06	for C-SYSTEM	154.91 PINS	2,70 €
	APM-07	for M-SYSTEM	S20R ET-NR 16 PINS	8,00 €
	APM-08	for M-SYSTEM	S25S MWLNR/L 06, EXTERNAL PINS	2,70 €
	APM-09	for M-SYSTEM	S16P MWLNR/L 06 PINS	2,70 €
	APM-10	for M-SYSTEM	S20R MWLNR/L 06 PINS	2,70 €
	APM-11	for M-SYSTEM	S20R MTQNR/L 16 PINS	2,70 €
	APM-12	for M-SYSTEM	S20R MCLNR/L 12, S25S MCLNR/L 12-Z PINS	2,70 €
	APM-13	for M-SYSTEM	S25S MCLNR/L 12 PINS	2,70 €
	APM-14	for M-SYSTEM	S25S MTFNR/L 16, S25S MT-NR/L 16, S25S MTUNR/L 16, S25S MTQNR/L 16 PINS	2,70 €
	APM-15	for M-SYSTEM	MSYNR 16CS 12 for CARTRIDGE SNMG 12 PINS	5,30 €

RING

PRODUCT PICTURE	CODE	PRODUCT DETAIL		PRICE / PREIS
	ACS-01	for C SYSTEM	TNGN, CNGN, DNGN, SNGN RING	1,40 €
	AS-01	for T-M- SYSTEM	AKV-30-M6x22 RING	1,40 €
	AS-02	for T SYSTEM	AKV-19-M7x25 RING	1,40 €

ORING

PRODUCT PICTURE	CODE	PRODUCT DETAIL		PRICE / PREIS
	AOR-01	for P-SYSTEM	ORING	1,40 €
	AXR-01	for T-P SYSTEM	ORING	1,40 €

STAMP

PRODUCT PICTURE	CODE	PRODUCT DETAIL		PRICE / PREIS
	ABPL-01	for T-SYSTEM	DNMG 11-15, WNMG 06-08, TNMG 16-22, VNMG 16, CNMG 12, SNMG 12 STAMP	0,40 €
		for M-SYSTEM	DELİK İÇİ Ø25-Ø32-Ø40 ve DIŞ ÇAP TNMG 16-22, DNMG 15, WNMG 08 STAMP	
		for C-SYSTEM	KNUX 16 STAMP	
	ABPL-02	for T-SYSTEM	CNMG 16 STAMP	0,40 €
	ABPL-03	for TER/L - TIR/L	TER - TIR 16 ER/EL - IR/IL SHIM SCREW STAMP	0,40 €
	ABPL-04	for TER/L - TIR/L	TER - TIR 22 ER/EL - IR/IL SHIM SCREW STAMP	0,40 €
	ABPL-05	for TER/L - TIR/L	TER - TIR 27 ER/EL - IR/IL SHIM SCREW STAMP	0,40 €

SPARE PARTS / ERSATZTEILE

CLAMP SPRING

PRODUCT PICTURE	CODE	PRODUCT DETAIL		PRICE / PREIS
	AKY-01	For T-SYSTEM	CNMG 12, WNMG 08, TNMG 22, DNMG 15, SNMG 12, VNMG 16 CLAMP SPRING	1,40 €
	AKY-02	For C-SYSTEM	KNUX 16 CLAMP SPRING	1,40 €

LEVERS

PRODUCT PICTURE	CODE	PRODUCT DETAIL		PRICE / PREIS
	APL-01	For P-SYSTEM	CNMG 09, DNMG 11, SNMG 09, TNMG 16, WNMG 06 LEVER	9,30 €
	APL-02	For P-SYSTEM	CNMG 12, SNMG 12, TNMG 22, WNMG 08 LEVER	9,30 €
	APL-03	For P-SYSTEM	DNMG 15 LEVER	9,30 €
	APL-04	For P-SYSTEM	CNMG 16, SNMG 15 LEVER	9,30 €
	APL-05	For P-SYSTEM	CNMG 19, SNMG 19 LEVER	15,80 €
	APL-06	For P-SYSTEM	CNMG 25, SNMG 25 LEVER	23,60 €
	APL-07	For P-SYSTEM	S16P PCLNR/L 09, S16P PTUNR/L 16 LEVER	9,30 €
	APL-08	For P-SYSTEM	S16P PTUNR/L 16 LEVER	9,30 €
	APL-11	For P-SYSTEM	TNMG 11 LEVER	9,30 €







LEVER SCREWS

PRODUCT PICTURE	CODE	PRODUCT DETAIL		PRICE / PREIS
	ALV-01-M6X14	For P-SYSTEM	INTERNAL Ø20 DNMG 11 Ø20 TNMG 16 LEVER SCREW (M6X14)	3,20 €
	ALV-02-M6X17	For P-SYSTEM	DNMG 11, TNMG 16, WNMG 06 LEVER SCREW (M6X17)	3,20 €
	ALV-03-M8X19	For P-SYSTEM	CNMG 12, SNMG 12, TNMG 22, WNMG 08, DNMG 15 LEVER SCREW (M8X19)	3,20 €
	ALV-04-M8X22	For P-SYSTEM	CNMG 16, SNMG 15 LEVER SCREW (M8X22)	3,20 €
	ALV-05-M10X27	For P-SYSTEM	CNMG 19, SNMG 19 LEVER SCREW (M10X27)	3,80 €
	ALV-06-M12X36	For P-SYSTEM	CNMG 25, SNMG 25 LEVER SCREW (M12X36)	6,90 €
	ALV-07-M6X13	For P-SYSTEM	S16P PCLNR/L 09, S16P PCTUR/L 16 LEVER SCREW (M6X13)	3,20 €
	ALV-08-M8X16	For P-SYSTEM	S25S PCLNR/L 12, S25S PDUNR/L 15, S25S PSKNR/L 12 LEVER SCREW	3,20 €
	ALV-10-M5X10	For P-SYSTEM	TNMG 11	3,20 €





SPARE PARTS / ERSATZTEILE

TORX SCREWS

PRODUCT PICTURE	CODE	PRODUCT DETAIL		PRICE / PREIS
	4006-M1.6X3.2	for S-SYSTEM	TORK SCREW	5,30 €
	3006-M1.8X4	for S-SYSTEM	TORK SCREW	6,60 €
	3006-M2x3.1	for S-SYSTEM	TORK SCREW	4,30 €
	3006-M2x3.3	for S-SYSTEM	TORK SCREW	4,30 €
	3006-M2X3.6	for S-SYSTEM	TORK SCREW	4,30 €
	3006-M2X4	for S-SYSTEM	TORK SCREW	4,30 €
	4006-M2X5	for S-SYSTEM	TORK SCREW	2,70 €
	3007-M2.2X5	for S-SYSTEM	TORK SCREW	4,30 €
	4006-M2.2X5	for S-SYSTEM	TORK SCREW	2,70 €
	1008-M2.5X5	for S-SYSTEM	TORK SCREW	1,40 €
	1008-M2.5X7	for S-SYSTEM	TORK SCREW	1,40 €
	1108-M2.5x6	for S-SYSTEM	TORK SCREW	8,00 €
	3008-M2.5X5	for S-SYSTEM	TORK SCREW	4,30 €
	3008-M2.5X6	for S-SYSTEM	TORK SCREW	4,30 €
	3008-M2.5X8	for S-SYSTEM	TORK SCREW	4,90 €
	4008-M2.5X4.5	for S-SYSTEM	TORK SCREW	2,70 €
	4008-M2.5X4	for S-SYSTEM	TORK SCREW	2,70 €
	4008-M2.5X4.5	for S-SYSTEM	TORK SCREW	2,70 €
	4008-M2.5X6	for S-SYSTEM	TORK SCREW	2,70 €
	4008-M2.5x6.5	for S-SYSTEM	TORK SCREW	2,70 €
	4108-M2.5x6.5	for S-SYSTEM	TORK SCREW	2,70 €
	4108-M2.5x8	for S-SYSTEM	TORK SCREW	2,70 €
	1008-M3X6	for S-SYSTEM	TORK SCREW	1,40 €
	1008-M3X8	for S-SYSTEM	TORK SCREW	1,40 €
	1108-M3x6.8	for S-SYSTEM	TORK SCREW	8,00 €
	3008-M3X6	for S-SYSTEM	TORK SCREW	4,30 €
	3008-M3X7	for S-SYSTEM	TORK SCREW	4,30 €
	3008-M3X8	for S-SYSTEM	TORK SCREW	4,30 €
	3108-M3x6	for S-SYSTEM	TORK SCREW	4,30 €
	4008-M3X8	for S-SYSTEM	TORK SCREW	2,70 €
	4010-M3X6	for S-SYSTEM	TORK SCREW	2,70 €
	4010-M3X8	for S-SYSTEM	TORK SCREW	2,70 €
	1015-M3.5X9	for S-SYSTEM	TORK SCREW	1,40 €
	1015-M3.5X11	for S-SYSTEM	TORK SCREW	1,40 €
	1015-M3.5X14	for S-SYSTEM	TORK SCREW	1,40 €
	1015-M3.5X16	for S-SYSTEM	TORK SCREW	1,40 €
	1315-M3.5X11	for S-SYSTEM	TORK SCREW	1,40 €
	1510-M3.5X7	for S-SYSTEM	TORK SCREW	1,40 €
	1510-M3.5X9	for S-SYSTEM	TORK SCREW	1,40 €
	1615-M3.5X10	for S-SYSTEM	TORK SCREW	1,40 €
	1615-M3.5X11	for S-SYSTEM	TORK SCREW	1,40 €
	1615-M3.5X15	for S-SYSTEM	TORK SCREW	1,40 €
	3010-M3.5X7	for S-SYSTEM	TORK SCREW	4,30 €
	3010-M3.5X9	for S-SYSTEM	TORK SCREW	4,30 €
	3015-M3.5X9	for S-SYSTEM	TORK SCREW	4,30 €
	4015-M3.5X8	for S-SYSTEM	TORK SCREW	2,70 €
	4015-M3.5X9	for S-SYSTEM	TORK SCREW	2,70 €
	4015-M3.5X10	for S-SYSTEM	TORK SCREW	2,70 €
	4015-M3.5X11	for S-SYSTEM	TORK SCREW	2,70 €
	4015-M3.5X12	for S-SYSTEM	TORK SCREW	2,70 €
	4015-M3.5X14	for S-SYSTEM	TORK SCREW	2,70 €
	1015-M4x8	for S-SYSTEM	TORK SCREW	4,00 €
	1015-M4X9	for S-SYSTEM	TORK SCREW	4,00 €
	1515-M4X9	for S-SYSTEM	TORK SCREW	1,40 €
	1115-M4x10	for S-SYSTEM	TORK SCREW	8,00 €
	1015-M4X11	for S-SYSTEM	TORK SCREW	4,00 €
	1315-M4X11	for S-SYSTEM	TORK SCREW	1,40 €
	1415-M4X11	for S-SYSTEM	TORK SCREW	1,40 €

SPARE PARTS / ERSATZTEILE

TORX SCREWS

PRODUCT PICTURE	CODE	PRODUCT DETAIL		PRICE / PREIS
	1515-M4X11	for S-SYSTEM	TORK SCREW	1,40 €
	1615-M4X11	for S-SYSTEM	TORK SCREW	1,40 €
	3015-M4X9	for S-SYSTEM	TORK SCREW	4,30 €
	3015-M4X11	for S-SYSTEM	TORK SCREW	4,30 €
	4015-M4x8	for S-SYSTEM	TORK SCREW	2,70 €
	4015-M4X9	for S-SYSTEM	TORK SCREW	2,70 €
	4015-M4x10	for S-SYSTEM	TORK SCREW	2,70 €
	4015-M4X11	for S-SYSTEM	TORK SCREW	2,70 €
	4015-M4X12	for S-SYSTEM	TORK SCREW	2,70 €
	4115-M4X12	for S-SYSTEM	TORK SCREW	2,70 €
	4515-M4x8	for S-SYSTEM	TORK SCREW	2,70 €
	4515-M4X11	for S-SYSTEM	TORK SCREW	2,70 €
	4615-M4X11	for S-SYSTEM	TORK SCREW	2,70 €
	1015-M4.5X12	for S-SYSTEM	TORK SCREW	1,40 €
	1020-M4.5x14	for S-SYSTEM	TORK SCREW	1,40 €
	1020-M4.5X16	for S-SYSTEM	TORK SCREW	1,40 €
	1120-M4.5X12	for S-SYSTEM	TORK SCREW	4,00 €
	1515-M4.5X11	for S-SYSTEM	TORK SCREW	1,40 €
	4015-M4.5X11	for S-SYSTEM	TORK SCREW	2,70 €
	4020-M4.5X10	for S-SYSTEM	TORK SCREW	2,70 €
	4020-M4.5X12	for S-SYSTEM	TORK SCREW	2,70 €
	1020-M5x7.5	for S-SYSTEM	TORK SCREW	1,40 €
	1020-M5X11	for S-SYSTEM	TORK SCREW	1,40 €
	1120-M5X13	for S-SYSTEM	TORK SCREW	4,30 €
	1020-M5X14	for S-SYSTEM	TORK SCREW	1,40 €
	1520-M5X11	for S-SYSTEM	TORK SCREW	2,70 €
	1615-M5x14	for S-SYSTEM	TORK SCREW	4,00 €
	1620-M5X18	for S-SYSTEM	TORK SCREW	4,30 €
	1620-M5X22	for S-SYSTEM	TORK SCREW	4,30 €
	4420-M5X14	for S-SYSTEM	TORK SCREW	2,70 €
	1020-M6X16	for S-SYSTEM	TORK SCREW	1,90 €
	1420-M6X16	for S-SYSTEM	TORK SCREW	1,90 €
	1520-M6X16	for S-SYSTEM	TORK SCREW	1,90 €
	1710-U5-40X12.2	for S-SYSTEM	TORK SCREW	4,30 €
	1720-U8-32x10	for S-SYSTEM	TORK SCREW	4,30 €
	1720-U8-32X15	for S-SYSTEM	TORK SCREW	4,30 €
	1707-U4-48x6	for S-SYSTEM	TORK SCREW	6,60 €
	1707-U4-48x6.5	for S-SYSTEM	TORK SCREW	6,60 €
	1707-U4-48X8.2	for S-SYSTEM	TORK SCREW	6,60 €



SPARE PARTS / ERSATZTEILE

SHIM SPRING

PRODUCT PICTURE	CODE	PRODUCT DETAIL		PRICE / PREIS
	AA Y-01	for P-SYSTEM	DNMG 11, TNMG 16, WNMG 06, CNMG 09, SNMG 09 SHIM SPRING	1,90 €
	AA Y-02	for P-SYSTEM	CNMG 12, SNMG 12, TNMG 22, WNMG 08, DNMG 15 SHIM SPRING	1,90 €
	AA Y-03	for P-SYSTEM	CNMG 16, SNMG 15 SHIM SPRING	1,90 €
	AA Y-04	for P-SYSTEM	CNMG 19, SNMG 19 SHIM SPRING	1,90 €
	AA Y-05	for P-SYSTEM	CNMG 25, SNMG 25 SHIM SPRING	3,60 €
	AA Y-07	for P-SYSTEM	CNMG 09, TNMG 16 SHIM SPRING	3,60 €

PROFIL MILLING SCREWS

PRODUCT PICTURE	CODE	PRODUCT DETAIL		PRICE / PREIS
	1208-M3x7	PROFIL MILLING SCREW-P3208 INSERT SCREW		8,00 €
	1215-M4X0.5X9	PROFIL MILLING SCREW-P3210-ROHX 12 INSERT SCREW		8,00 €
	1220-M5X0.5X9	PROFIL MILLING SCREW-P3212 INSERT SCREW		8,00 €
	1220-M5X0.5X12	PROFIL MILLING SCREW-P3216-ROHX 16 INSERT SCREW		8,00 €
	1220-M5X0.5X15	PROFIL MILLING SCREW-ROHX 20 INSERT SCREW		8,00 €
	1220-M6X0.75X20	PROFIL MILLING SCREW-P3225 INSERT SCREW		10,60 €
	1204-M8X0.75X26	PROFIL MILLING SCREW-P3232 INSERT SCREW		13,10 €
	1210-M3.5X9.6	PROFIL MILLING SCREW-BNM 12 INSERT SCREW		13,10 €
	1215-M4X13.5	PROFIL MILLING SCREW-BNM 16 INSERT SCREW		13,10 €

EXCENTRIC SCREW

PRODUCT PICTURE	CODE	PRODUCT DETAIL		PRICE / PREIS
	AEV-01-M6x16	ECCENTRIC SCREW		8,00 €

BLOCKS For PARTING and DEEP GROOVING BLADE CLAMPS

PRODUCT PICTURE	CODE	PRODUCT DETAIL		PRICE / PREIS
	ABK-01	for BLADE BLOCK	ALBU-20-26 CLAMP	26,20 €
	ABK-02	for BLADE BLOCK	ALBU-25-26 CLAMP	26,20 €
	ABK-03	for BLADE BLOCK	ALBU-20-32 CLAMP	28,90 €
	ABK-04	for BLADE BLOCK	ALBU-25-32, ALBU-32-32 CLAMP	28,90 €

JET TOOLS

PRODUCT PICTURE	CODE	PRODUCT DETAIL		PRICE / PREIS
	2704-M8x1x5	for WITH COOLANT TOOLS	for JET TOOLS	1,40 €
	2705-G1/8x5.5	for WITH COOLANT TOOLS	for JET TOOLS	1,90 €

SPARE PARTS / ERSATZTEILE

MOUNTING and ADJUSTING SCREWS

PRODUCT PICTURE	CODE	PRODUCT DETAIL	PRICE / PREIS
	2406-M8x30	A16 MOUNTING SCREW (SMALL HEAD)	2,20 €
	2506-M8x30	A16 MOUNTING SCREW	2,20 €
	2407-M10x30	A22 MOUNTING SCREW	2,20 €
	2408-M10x30	A22 MOUNTING SCREW (SMALL HEAD)	2,20 €
	2508-M10x30	A22 MOUNTING SCREW	2,20 €
	2408-M12x35	A27 MOUNTING SCREW	2,20 €
	2510-M12x35	A27 MOUNTING SCREW	2,20 €
	2514-M16x35	A32 MOUNTING SCREW	2,20 €
	2504-M5x16	CARTRIDGE MOUNTING SCREW	2,20 €
	2505-M6x16	CARTRIDGE MOUNTING SCREW	2,20 €
	AKV-23-M4x10	CARTRIDGE MOUNTING SCREW	2,20 €
	2600-M4x9.5	CARTRIDGE AXIAL ADJUST SCREW	2,20 €
	2600-M5x13	CARTRIDGE AXIAL ADJUST SCREW	2,20 €
	2600-M6x18	CARTRIDGE AXIAL ADJUST SCREW	2,20 €
	2702-M4x4	CARTRIDGE AXIAL ADJUST SCREW	1,40 €
	2702-M4x10	CARTRIDGE AXIAL ADJUST SCREW	1,40 €
2725-M5x6	CARTRIDGE AXIAL ADJUST SCREW	1,40 €	
2725-M5x10	CARTRIDGE AXIAL ADJUST SCREW	1,40 €	

ALLEN KEYS

PRODUCT PICTURE	CODE	PRODUCT DETAIL	PRICE / PREIS
	AAL-01-2 mm	ALLEN KEY	1,40 €
	AAL-02-2.5 mm	ALLEN KEY	1,40 €
	AAL-03-3 mm	ALLEN KEY	1,40 €
	AAL-05-4 mm	ALLEN KEY	1,70 €
	AAL-07-5 mm	ALLEN KEY	2,20 €
	AAL-08-6 mm	ALLEN KEY	3,30 €
	AAL-09-1.5 mm	ALLEN KEY	1,40 €
	AAL-11-8 mm	ALLEN KEY	5,30 €
	AAL-12-10 mm	ALLEN KEY	8,00 €

TORX KEYS

PRODUCT PICTURE	CODE	PRODUCT DETAIL	PRICE / PREIS
	82-T06	TORX KEY	7,30 €
	82-T07	TORX KEY	7,30 €
	82-T08	TORX KEY	7,30 €
	82-T10	TORX KEY	7,30 €
	82-T15	TORX KEY	7,30 €
	82-T20	TORX KEY	7,30 €
	81-T15	T-TYPE TORX KEY	4,00 €
	81-T20	T-TYPE TORX KEY	4,00 €

BLADE KEY

PRODUCT PICTURE	CODE	PRODUCT DETAIL	PRICE / PREIS
	ALA-02	AKL BLADE KEY	15,80 €

SPARE PARTS / ERSATZTEILE

ROUGH BORING HEADS

PRODUCT PICTURE	CODE	PRODUCT DETAIL	PRICE / PREIS
	ABKS-D16	ABKS-D16 CARTRIDGE FIXING CLAMP	8,00 €
	ABKS-D20	ABKS-D20 CARTRIDGE FIXING CLAMP	8,00 €
	ABKS-D25	ABKS-D25 CARTRIDGE FIXING CLAMP	8,00 €
	ABKS-D32	ABKS-D32 CARTRIDGE FIXING CLAMP	8,00 €
	ABKS-D40	ABKS-D40 CARTRIDGE FIXING CLAMP	8,00 €
	ABKS-D50	ABKS-D50 CARTRIDGE FIXING CLAMP	13,10 €
	ABKS-D63	ABKS-D63 CARTRIDGE FIXING CLAMP	13,10 €
	ABKS-D80	ABKS-D80 CARTRIDGE FIXING CLAMP	13,10 €
	2525-M3X14	2525-M3X14 CARTRIDGE MOUNTING SCREW	2,20 €
	2503-M4X12	2503-M4X12 CARTRIDGE MOUNTING SCREW	2,20 €
	2503-M4X15	2503-M4X15 CARTRIDGE MOUNTING SCREW	2,20 €
	2503-M4X20	2503-M4X20 CARTRIDGE MOUNTING SCREW	2,20 €
	2504-M5X25	2504-M5X25 CARTRIDGE MOUNTING SCREW	2,20 €
	2505-M6X30	2505-M6X30 CARTRIDGE MOUNTING SCREW	2,20 €
	2306-M8X37	2306-M8X37 MOUNTING SCREW (SMALL HEAD)	2,20 €
	2405-M8X30	A16 MOUNTING SCREW (SMALL HEAD)	2,20 €
	2506-M8X35	2506-M8X35 CARTRIDGE MOUNTING SCREW	2,20 €
	2508-M10X40	2508-M10X40 CARTRIDGE MOUNTING SCREW	2,20 €
	2510-M12X40	2510-M12X40 IMBUS SCREW	2,20 €
	2715-M3X4	2715-M3X4 CARTRIDGE RADIAL ADJUST SCREW	1,40 €
	2715-M3X5	2715-M3X5 CARTRIDGE RADIAL ADJUST SCREW	1,40 €
	2715-M3X8	2715-M3X8 CARTRIDGE RADIAL ADJUST SCREW	1,40 €
	2702-M4X12	2702-M4X12 CARTRIDGE RADIAL ADJUST SCREW	1,40 €
	2725-M5X12	2725-M5X12 CARTRIDGE RADIAL ADJUST SCREW	1,40 €
	2725-M5X14	2725-M5X14 CARTRIDGE RADIAL ADJUST SCREW	1,40 €
	2703-M6X16	2703-M6X16 CARTRIDGE RADIAL ADJUST SCREW	1,40 €
	2704-M8X25	2704-M8X25 CARTRIDGE RADIAL ADJUST SCREW	1,40 €











GROOVING TOOLS SCREWS

PRODUCT PICTURE	CODE	PRODUCT DETAIL	PRICE / PREIS
	AKV-02-M6x22	GROOVING TOOLS SCREW	2,20 €
	AKV-08-M6X12	C-SYSTEM MILLING SCREW	3,70 €
	AKV-09-M8X18	C-SYSTEM MILLING SCREW	4,30 €
	AKV-29-M6x29	GROOVING TOOLS SCREW	4,00 €
	2503-M4x10	GROOVING TOOLS SCREW	2,20 €
	2503-M4x16	GROOVING TOOLS SCREW	2,20 €
	2504-M5x12	GROOVING TOOLS SCREW	2,20 €
	2504-M5x16	GROOVING TOOLS SCREW	2,20 €
	2505-M6x16	GROOVING TOOLS SCREW	2,20 €
	2505-M6x20	GROOVING TOOLS SCREW	2,20 €
	2505-M6X25	for BLOCK CLAMP SCREW	2,20 €
	2004-M8x20	GROOVING TOOLS SCREW	2,70 €
	2004-M8x1x20	GROOVING TOOLS SCREW	2,70 €
	1904-M8x1x20	GROOVING TOOLS SCREW	2,70 €

ANTI-SEIZE LUBRICANT

PRODUCT PICTURE	PRODUCT DETAIL	PRICE / PREIS
	ANTI-SEIZE LUBRICANT	4,30 €

COOLANT HOSE SET

INDIVIDUAL COMPONENTS				List Price pcs	Set Code : ACHS-1-250	Set Code : ACHS-2-250	Set Code : ACHS-3-250
Picture	Ordering Code	Product Detail	Length : 250 mm		Length : 250 mm	Length : 250 mm	
					Set Price : 65,00 €	Set Price : 73,00 €	Set Price : 75,00 €
① 	AMP-01	M10 Fastener	4,70 €	1 pcs	-	-	
② 	AMP-02	G1/8" Double Fastener	4,20 €	2 pcs	1 pcs	-	
③ 	AMP-03	G1/8" Angle Connection	4,00 €	-	1 pcs	2 pcs	
④ 	AMP-04	M10 Angle Connection	3,90 €	-	1 pcs	1 pcs	
⑤ 	AMP-05	G1/4"-G1/8 Capillary Piece	6,40 €	-	1 pcs	1 pcs	
⑥ 	AG-01	Copper Gasket	1,40 €	2 pcs	3 pcs	4 pcs	
⑦ 	2705-G1/8X5.5	G1/8" Sealing Bolt	1,90 €	1 pcs	1 pcs	1 pcs	
⑧ 	AH-1-250	Hose	60,10 €	1 pcs	-	-	
⑨ 	AH-2-250	Hose	63,00 €	-	1 pcs	-	
⑩ 	AH-3-250	Hose	64,30 €	-	-	1 pcs	



konusulan kalite • the spoken quality • qualität über die man spricht





konusulan
the spoken **kalite...**
quality...



www.akko.com.tr

konusulan
the spoken **kalite...**
quality...





