

Kramer Electronics, Ltd.



USER MANUAL

Models:

VM-3AN, 1:3 Audio DA

VM-3SN, 1:3 s-Video DA

VM-3VN, 1:3 Video DA

Contents

1	Introduction	1
2	Getting Started	1
2.1	Quick Start	1
3	Overview	3
3.1	VM-3AN Audio DA	3
3.2	VM-3SN s-Video DA	3
3.3	VM-3VN Video DA	3
3.4	Achieving the Best Performance	4
4	Your Distribution Amplifier	4
4.1	Your VM-3AN Audio DA	5
4.2	Your VM-3SN s-Video DA	6
4.3	Your VM-3VN Video DA	7
5	Connecting Your Distribution Amplifier	7
5.1	Connecting Your VM-3AN Audio DA	8
5.2	Connecting Your VM-3SN s-Video DA	9
5.3	Connecting Your VM-3VN Video DA	10
6	Technical Specifications	11

Figures

Figure 1:	VM-3AN Audio DA	5
Figure 2:	VM-3SN s-Video DA	6
Figure 3:	VM-3VN Video DA	7
Figure 4:	Connecting the VM-3AN Audio Distributor	8
Figure 5:	Connecting the VM-3SN s-Video Distributor	9
Figure 6:	Connecting the VM-3VN Video Distributor	10

Tables

Table 1:	VM-3AN Audio DA Features	5
Table 2:	VM-3SN s-Video DA Features	6
Table 3:	VM-3VN Video DA Features	7
Table 4:	Technical Specifications	11

1 Introduction

Welcome to Kramer Electronics! Since 1981, Kramer Electronics has been providing a world of unique, creative, and affordable solutions to the vast range of problems that confront the video, audio, presentation, and broadcasting professional on a daily basis. In recent years, we have redesigned and upgraded most of our line, making the best even better! Our 1,000-plus different models now appear in 11 groups¹ that are clearly defined by function.

Thank you for purchasing your Kramer TOOLSTTM **VM-3AN Audio DA**, **VM-3SN s-Video DA**, and/or **VM-3VN Video DA**.

These products are ideal for the following typical applications:

- Audio duplication studios, delivering high-quality audio and video duplicates
- Broadcast and production studios for signal distribution
- Presentation and multimedia distribution
- Field distribution

The package includes the following items:

- **VM-3AN Audio DA**, or **VM-3SN s-Video DA**, or **VM-3VN Video DA**
- Power adapter, this user manual²

2 Getting Started

We recommend that you:

- Unpack the equipment carefully and save the original box and packaging materials for possible future shipment
- Review the contents of this user manual
- Use Kramer high-performance high-resolution cables³

2.1 Quick Start

This quick start chart summarizes the basic setup and operation:

1 GROUP 1: Distribution Amplifiers; GROUP 2: Switchers and Matrix Switchers; GROUP 3: Control Systems; GROUP 4: Format/Standards Converters; GROUP 5: Range Extenders and Repeaters; GROUP 6: Specialty AV Products; GROUP 7: Scan Converters and Scalers; GROUP 8: Cables and Connectors; GROUP 9: Room Connectivity; GROUP 10: Accessories and Rack Adapters; GROUP 11: Sierra Products

2 Download up-to-date Kramer user manuals from the Internet at this URL: <http://www.kramerelectronics.com>

3 The complete list of Kramer cables is on our Web site at <http://www.kramerelectronics.com>

Step 1: Connect the machine - see section 5

VM-3AN

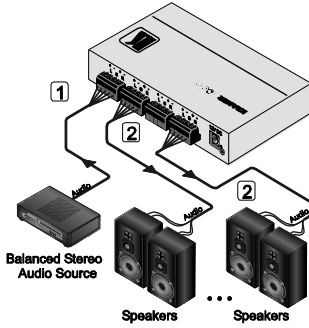

- 1 Connect the input.
- 2 Connect the outputs.

VM-3SN

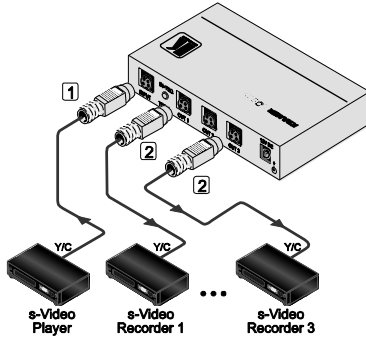

- 1 Connect the input.
- 2 Connect the outputs.

VM-3VN

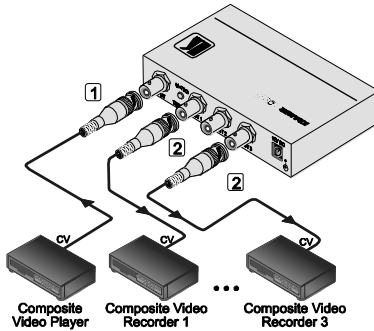

- 1 Connect the input.
- 2 Connect the outputs.

Step 2: Connect the power

If required, adjust the following:
VM-3AN - LEFT and RIGHT audio signal levels
VM-3SN - Y and C signal levels
VM-3VN - EQ and LEVEL



3 Overview

This section gives a summary of:

- The **VM-3AN Audio DA**, see section 3.1
- The **VM-3SN s-Video DA**, see section 3.2
- The **VM-3VN Video DA**, see section 3.3
- Recommendations for achieving the best performance, see section 3.4

3.1 VM-3AN Audio DA

The **VM-3AN** is a high-quality 1:3 balanced stereo audio distribution amplifier. It accepts one balanced stereo input on a removable terminal block and distributes the signal to three identical outputs on removable terminal blocks.

Specifically, the **VM-3AN** features:

- Left and right signal level trimmers on the front panel
- 12V DC power

3.2 VM-3SN s-Video DA

The **VM-3SN** is a high-quality 1:3 distribution amplifier for s-Video signals. It accepts one s-Video input on a 4-pin connector and distributes the signal to three identical outputs on 4-pin connectors.

Specifically, the **VM-3SN** features:

- C and Y level trimmers on the front panel
- 12V DC power

3.3 VM-3VN Video DA

The **VM-3VN** is a high-quality 1:3 distribution amplifier for composite video signals. It accepts one composite video input on a BNC connector and distributes the signal to three identical composite video outputs on BNC connectors.

Specifically, the **VM-3VN** features:

- EQ and LEVEL trimmers on the front panel
- 12V DC power

3.4 Achieving the Best Performance

To achieve the best performance:

- Use only good quality connection cables¹ to avoid interference, deterioration in signal quality due to poor matching, and elevated noise levels (often associated with low quality cables).
- Avoid interference from neighboring electrical appliances that may adversely influence signal quality and position your Kramer products away from moisture, excessive sunlight and dust



Caution – No operator-serviceable parts inside unit.

Warning – Use only the Kramer Electronics input power wall adapter that is provided with this unit².

Warning – Disconnect power and unplug unit from wall before installing or removing device or servicing unit.

4 Your Distribution Amplifier

This section defines your:

- **VM-3AN** *Audio DA*, see section 4.1
- **VM-3SN** *s-Video DA*, see section 4.2
- **VM-3VN** *Video DA*, see section 4.3

¹ Available from Kramer Electronics on our Web site at <http://www.kramerelectronics.com>

² For example, part number 2535-000251

4.1 Your VM-3AN Audio DA

Figure 1 and Table 1 define the VM-3AN:

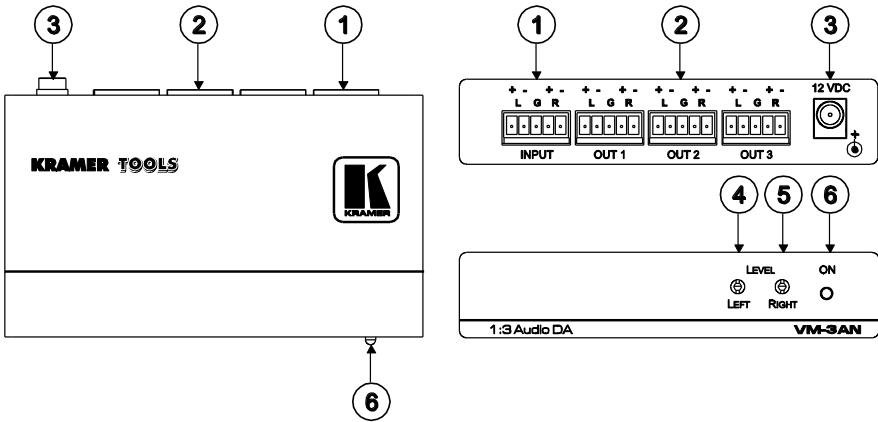

Figure 1: VM-3AN Audio DA

Table 1: VM-3AN Audio DA Features

#	Feature	Function
1	INPUT Detachable Terminal Block Connector	Connects to the balanced audio source
2	OUT Detachable Terminal Block Connector	Connects to the balanced audio acceptor (from 1 to 3)
3	12V DC	+12V DC connector for powering the unit
4	LEFT LEVEL Trimmer	Adjusts ¹ the left output signal level
5	RIGHT LEVEL Trimmer	Adjusts ¹ the right output signal level
6	ON LED	Illuminates when receiving power

¹ Insert a screwdriver into the small hole and carefully rotate it, trimming the appropriate output level

4.2 Your VM-3SN s-Video DA

Figure 2 and Table 2 define the VM-3SN:

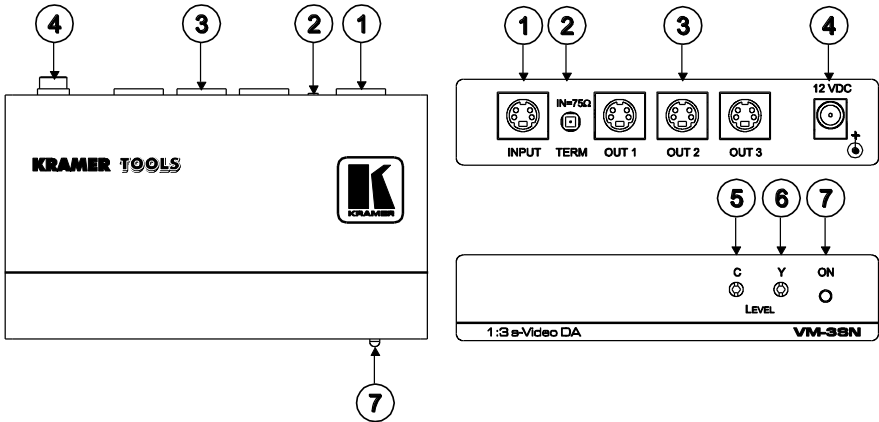

Figure 2: VM-3SN s-Video DA

Table 2: VM-3SN s-Video DA Features

#	Feature	Function
1	INPUT 4-pin Connector	Connects to the s-Video source
2	IN=75Ω TERM Pushbutton	Terminates the input with 75Ω
3	OUT 4-pin Connector	Connects to the audio acceptor (from 1 to 3)
4	12V DC	+12V DC connector for powering the unit
5	C LEVEL Trimmer	Adjusts ¹ the chrominance output signal level for the s-Video output
6	Y LEVEL Trimmer	Adjusts ¹ the luminance output signal level for the s-Video output
7	ON LED	Illuminates when receiving power

¹ Insert a screwdriver into the small hole and carefully rotate it, trimming the appropriate output level

4.3 Your VM-3VN Video DA

Figure 3 and Table 3 define the VM-3VN:

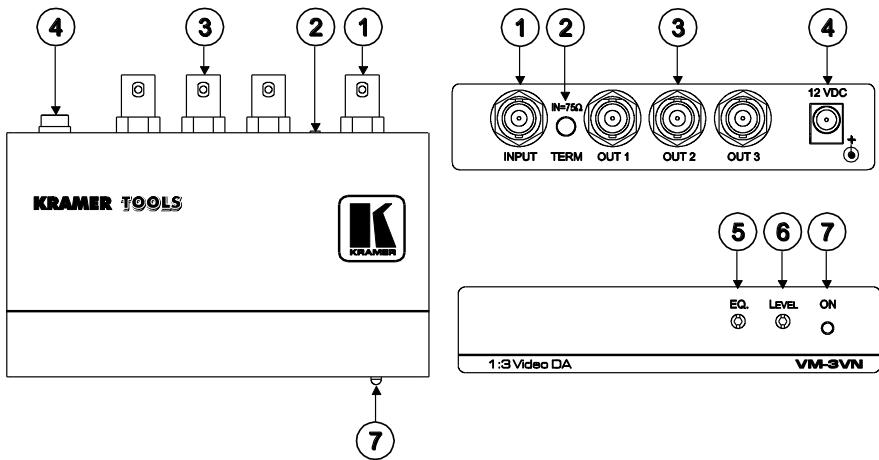

Figure 3: VM-3VN Video DA

Table 3: VM-3VN Video DA Features

#	Feature	Function
1	INPUT BNC Connector	Connects to the composite video source
2	IN=75Ω TERM Pushbutton	Terminates the input with 75Ω
3	OUT BNC Connector	Connects to the composite video acceptor (from 1 to 3)
4	12V DC	+12V DC connector for powering the unit
5	EQ Trimmer	Adjusts ¹ the EQ. (equalization) compensation level for the composite video outputs
6	LEVEL Trimmer	Adjusts ¹ signal level for the composite video outputs
7	ON LED	Illuminates when receiving power

5 Connecting Your Distribution Amplifier

This section explains how to connect your:

- VM-3AN Audio DA, see section 5.1
- VM-3SN s-Video DA, see section 5.2
- VM-3VN Video DA, see section 5.3

¹ Insert a screwdriver into the small hole and carefully rotate it, trimming the appropriate output level

5.1 Connecting Your VM-3AN Audio DA

To connect¹ the VM-3AN, as illustrated in the example in *Figure 4*, do the following:

1. Connect the balanced stereo audio source to the INPUT terminal block connector.
2. Connect the OUT terminal block connectors (from 1 to 3) to up to three balanced stereo audio acceptors² (for example, power amplifiers).
3. Connect the 12V DC power adapter to the power socket and connect the adapter to the mains electricity (not illustrated in *Figure 4*).
4. If required, adjust the audio signal levels by turning the LEFT and RIGHT level trimmers with a small screwdriver.

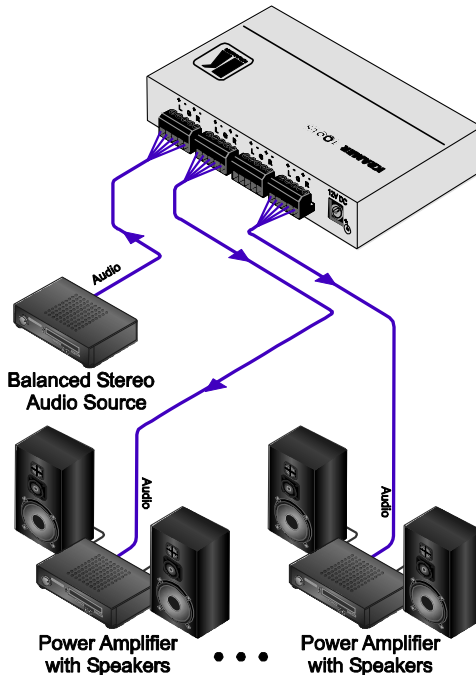

Figure 4: Connecting the VM-3AN Audio Distributor

¹ Switch OFF the power on each device before connecting it to your VM-3AN. After connecting your VM-3AN, switch on its power and then switch on the power on each device

² You do not have to connect all the outputs

5.2 Connecting Your VM-3SN s-Video DA

To connect¹ the VM-3SN, as illustrated in the example in *Figure 5*, do the following:

1. Connect the s-Video source (for example, an s-Video player) to the INPUT 4-pin connector.
2. Terminate the input by ensuring that the TERM switch is pressed to the IN position.
3. Connect the OUT 4-pin connectors (from 1 to 3) to up to three s-Video acceptors² (for example, s-Video recorders).
4. Connect the 12V DC power adapter to the power socket and connect the adapter to the mains electricity (not illustrated in *Figure 5*).
5. If required, adjust output chrominance (C) and luminance (Y) signal levels by turning the appropriate trimmer with a small screwdriver.

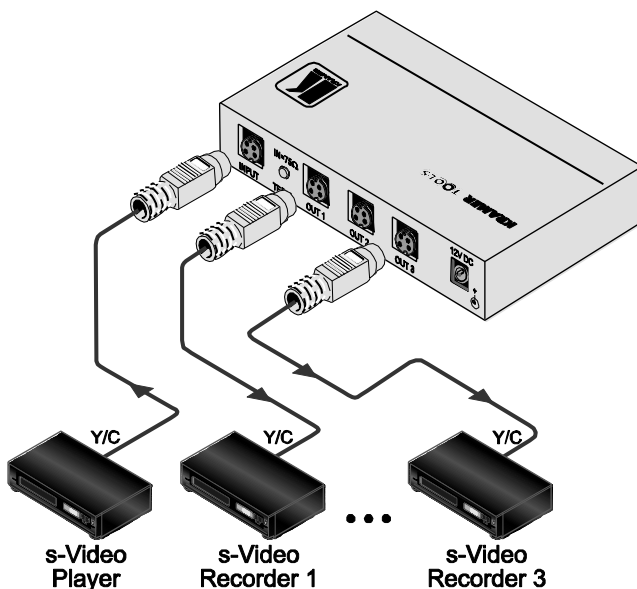

Figure 5: Connecting the VM-3SN s-Video Distributor

¹ Switch OFF the power on each device before connecting it to your VM-3SN. After connecting your VM-3SN, switch on its power and then switch on the power on each device

² You do not have to connect all the outputs

5.3 Connecting Your VM-3VN Video DA

To connect¹ the VM-3VN, as illustrated in the example in *Figure 6*, do the following:

1. Connect the composite video source to the INPUT BNC connector.
2. Terminate the input by ensuring that the TERM switch is pressed to the IN position.
3. Connect the OUT BNC connectors (from 1 to 3) to up to three composite video acceptors².
4. Connect the 12V DC power adapter to the power socket and connect the adapter to the mains electricity (not illustrated in *Figure 6*).
5. If required, adjust output equalization (EQ) and signal level (LEVEL) by turning the appropriate trimmer with a small screwdriver.

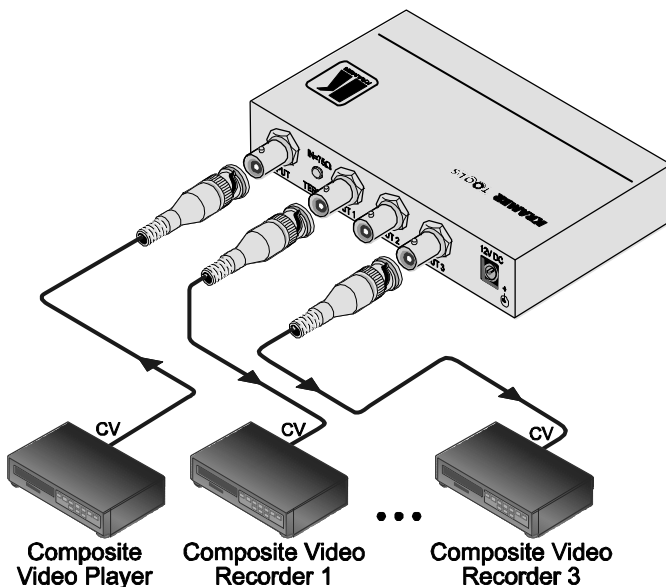

Figure 6: Connecting the VM-3VN Video Distributor

1 Switch OFF the power on each device before connecting it to your VM-3VN. After connecting your VM-3VN, switch on its power and then switch on the power on each device

2 You do not have to connect all the outputs

6 Technical Specifications

Table 4 includes the technical specifications.

Table 4: Technical Specifications

	VM-3AN	VM-3SN	VM-3VN
INPUT:	1 balanced audio stereo on 5-pin terminal blocks	1 YC on a 4-pin connector	1 composite video on a BNC connector
OUTPUTS:	3 balanced audio stereo on 5-pin terminal blocks	3 YC on 4-pin connectors	3 composite video on BNC connectors
MAX. INPUT / OUTPUT LEVEL:	18.5Vpp	2Vpp, Y	1.8Vpp
BANDWIDTH (-3dB):	>100 kHz	135MHz	430MHz
DIFF GAIN:	–	0.03%	0.12%
DIFF PHASE:	–	0.03Deg	0.03Deg
K-FACTOR:	–	<0.05%	<0.05%
S/N RATIO:	90dB @1kHz	78dB @5MHz	74.3dB
CONTROL:	Output level control: -77 to +6dB, R+/-, L+/- channels	Y-level: -1.6 to +6.3dB; C-level: -0.4 to +7.6dB	Level: -1.6 to +6dB; Equalization: 0 to +6dB
COUPLING:	–	AC	AC
AUDIO THD + NOISE:	0.008%	–	–
AUDIO 2d HARMONIC:	0.001%	–	–
POWER SOURCE:	12V DC, 89mA	12V DC, 29mA	12V DC, 27mA
DIMENSIONS:	11.7cm x 6cm x 3.2cm (4.6" x 2.4" x 1.3") W, D, H		
WEIGHT:	0.28 kg (0.62 lbs.) approx.		
ACCESSORIES:	Power supply		
OPTIONS:	Rack adapter		

LIMITED WARRANTY

The warranty obligations of Kramer Electronics for this product are limited to the terms set forth below:

What is Covered

This limited warranty covers defects in materials and workmanship in this product.

What is Not Covered

This limited warranty does not cover any damage, deterioration or malfunction resulting from any alteration, modification, improper or unreasonable use or maintenance, misuse, abuse, accident, neglect, exposure to excess moisture, fire, improper packing and shipping (such claims must be presented to the carrier), lightning, power surges, or other acts of nature. This limited warranty does not cover any damage, deterioration or malfunction resulting from the installation or removal of this product from any installation, any unauthorized tampering with this product, any repairs attempted by anyone unauthorized by Kramer Electronics to make such repairs, or any other cause which does not relate directly to a defect in materials and/or workmanship of this product. This limited warranty does not cover cartons, equipment enclosures, cables or accessories used in conjunction with this product.

Without limiting any other exclusion herein, Kramer Electronics does not warrant that the product covered hereby, including, without limitation, the technology and/or integrated circuit(s) included in the product, will not become obsolete or that such items are or will remain compatible with any other product or technology with which the product may be used.

How Long Does this Coverage Last

Seven years as of this printing; please check our Web site for the most current and accurate warranty information.

Who is Covered

Only the original purchaser of this product is covered under this limited warranty. This limited warranty is not transferable to subsequent purchasers or owners of this product.

What Kramer Electronics will do

Kramer Electronics will, at its sole option, provide one of the following three remedies to whatever extent it shall deem necessary to satisfy a proper claim under this limited warranty:

1. Elect to repair or facilitate the repair of any defective parts within a reasonable period of time, free of any charge for the necessary parts and labor to complete the repair and restore this product to its proper operating condition. Kramer Electronics will also pay the shipping costs necessary to return this product once the repair is complete.
2. Replace this product with a direct replacement or with a similar product deemed by Kramer Electronics to perform substantially the same function as the original product.
3. Issue a refund of the original purchase price less depreciation to be determined based on the age of the product at the time remedy is sought under this limited warranty.

What Kramer Electronics will not do Under This Limited Warranty

If this product is returned to Kramer Electronics or the authorized dealer from which it was purchased or any other party authorized to repair Kramer Electronics products, this product must be insured during shipment, with the insurance and shipping charges prepaid by you. If this product is returned uninsured, you assume all risks of loss or damage during shipment. Kramer Electronics will not be responsible for any costs related to the removal or re-installation of this product from or into any installation. Kramer Electronics will not be responsible for any costs related to any setting up this product, any adjustment of user controls or any programming required for a specific installation of this product.

How to Obtain a Remedy under this Limited Warranty

To obtain a remedy under this limited warranty, you must contact either the authorized Kramer Electronics reseller from whom you purchased this product or the Kramer Electronics office nearest you. For a list of authorized Kramer Electronics resellers and/or Kramer Electronics authorized service providers, please visit our web site at www.kramerelectronics.com or contact the Kramer Electronics office nearest you.

In order to pursue any remedy under this limited warranty, you must possess an original, dated receipt as proof of purchase from an authorized Kramer Electronics reseller. If this product is returned under this limited warranty, a return authorization number, obtained from Kramer Electronics, will be required. You may also be directed to an authorized reseller or a person authorized by Kramer Electronics to repair the product.

If it is decided that this product should be returned directly to Kramer Electronics, this product should be properly packed, preferably in the original carton, for shipping. Cartons not bearing a return authorization number will be refused.

Limitation on Liability

THE MAXIMUM LIABILITY OF KRAMER ELECTRONICS UNDER THIS LIMITED WARRANTY SHALL NOT EXCEED THE ACTUAL PURCHASE PRICE PAID FOR THE PRODUCT. TO THE MAXIMUM EXTENT PERMITTED BY LAW, KRAMER ELECTRONICS IS NOT RESPONSIBLE FOR DIRECT, SPECIAL, INCIDENTAL OR CONSEQUENTIAL DAMAGES RESULTING FROM ANY BREACH OF WARRANTY OR CONDITION, OR UNDER ANY OTHER LEGAL THEORY. Some countries, districts or states do not allow the exclusion or limitation of relief, special, incidental, consequential or indirect damages, or the limitation of liability to specified amounts, so the above limitations or exclusions may not apply to you.

Exclusive Remedy

TO THE MAXIMUM EXTENT PERMITTED BY LAW, THIS LIMITED WARRANTY AND THE REMEDIES SET FORTH ABOVE ARE EXCLUSIVE AND IN LIEU OF ALL OTHER WARRANTIES, REMEDIES AND CONDITIONS, WHETHER ORAL OR WRITTEN, EXPRESS OR IMPLIED. TO THE MAXIMUM EXTENT PERMITTED BY LAW, KRAMER ELECTRONICS SPECIFICALLY DISCLAIMS ANY AND ALL IMPLIED WARRANTIES, INCLUDING WITHOUT LIMITATION, WARRANTIES OF MERCHANTABILITY AND FITNESS FOR A PARTICULAR PURPOSE. IF KRAMER ELECTRONICS CANNOT LAWFULLY DISCLAIM OR EXCLUDE IMPLIED WARRANTIES UNDER APPLICABLE LAW, THEN ALL IMPLIED WARRANTIES COVERING THIS PRODUCT, INCLUDING WARRANTIES OF MERCHANTABILITY AND FITNESS FOR A PARTICULAR PURPOSE, SHALL APPLY TO THIS PRODUCT AS PROVIDED UNDER APPLICABLE LAW.

IF ANY PRODUCT TO WHICH THIS LIMITED WARRANTY APPLIES IS A "CONSUMER PRODUCT" UNDER THE MAGNUSON-MOSS WARRANTY ACT (15 U.S.C.A. §2301, ET SEQ.) OR OTHER APPLICABLE LAW, THE FOREGOING DISCLAIMER OF IMPLIED WARRANTIES SHALL NOT APPLY TO YOU, AND ALL IMPLIED WARRANTIES ON THIS PRODUCT, INCLUDING WARRANTIES OF MERCHANTABILITY AND FITNESS FOR THE PARTICULAR PURPOSE, SHALL APPLY AS PROVIDED UNDER APPLICABLE LAW.

Other Conditions

This limited warranty gives you specific legal rights, and you may have other rights which vary from country to country or state to state.

This limited warranty is void if (i) the label bearing the serial number of this product has been removed or defaced, (ii) the product is not distributed by Kramer Electronics or (iii) this product is not purchased from an authorized Kramer Electronics reseller. If you are unsure whether a reseller is an authorized Kramer Electronics reseller, please visit our Web site at www.kramerelectronics.com or contact a Kramer Electronics office from the list at the end of this document.

Your rights under this limited warranty are not diminished if you do not complete and return the product registration form or complete and submit the online product registration form. Kramer Electronics thanks you for purchasing a Kramer Electronics product. We hope it will give you years of satisfaction.



For the latest information on our products and a list of Kramer distributors, visit our Web site where updates to this user manual may be found.

We welcome your questions, comments, and feedback.

Web site: www.kramerelectronics.com

E-mail: info@kramereel.com



SAFETY WARNING

Disconnect the unit from the power supply before opening and servicing

P/N:



2900-000486

Rev:



2

Kramer Electronics, Ltd.

Web site: www.kramerelectronics.com

E-mail: info@kramereel.com

2900-000486 REV 2