

INSTALLATION INSTRUCTIONS

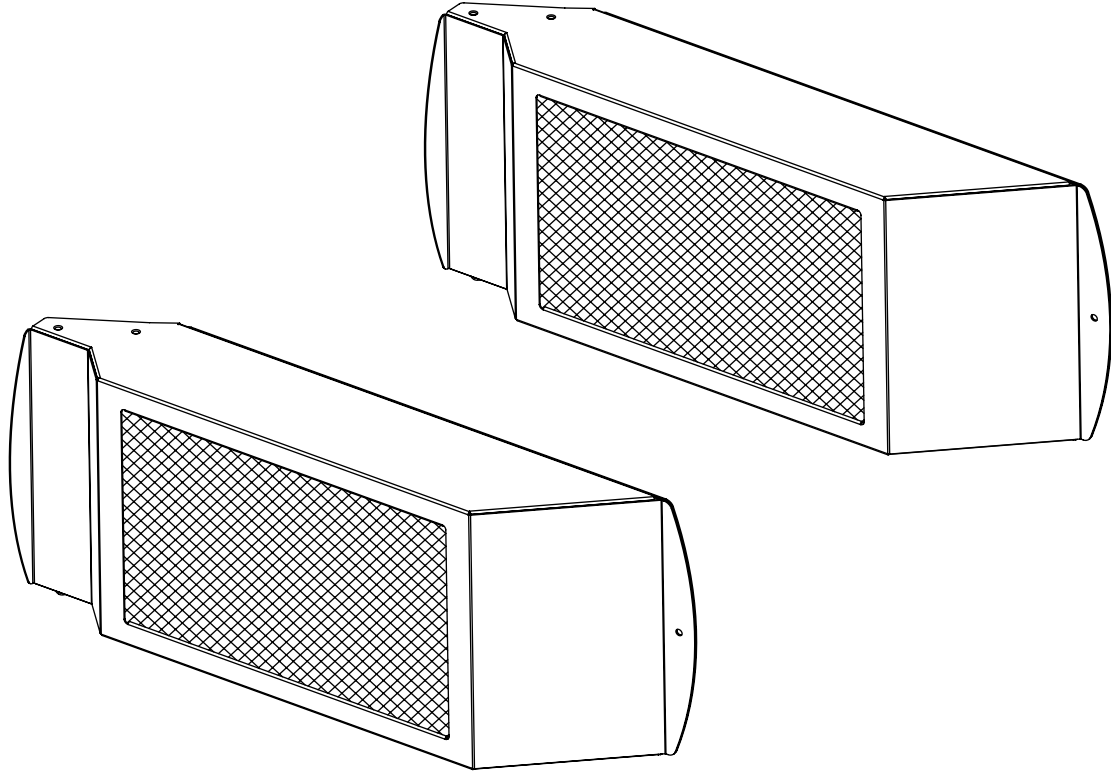

UNI-SPKR/UNI-SPKRB

On-Wall Speakers

NORTH AMERICA

3130 East Miraloma Avenue
Anaheim, CA 92806 USA

USA and Canada

Phone: 1.800.368.9700
Fax: 1.800.832.4888

Other Locations

Phone: (001).714.632.7100
Fax: (001).714.632.1044

EUROPE

Swallow House,
Shilton Industrial Estate,
Shilton, Coventry, England CV79JY

Phone: +44 (0) 2476 614700
Fax: +44 (0) 2476 614710



Contents

Warning Statements 2

Installation Tools 3

Parts List 3

Features 4

Installing the On-Wall Speakers 5

 Introduction 5

 Wiring 5

 Installing the Power Amp (sold separately) 7

 Attaching Speakers to the GearBox™ 7

 Aiming the Speakers (optional) 8

Technical Specifications 9

Warranty 10

Disclaimer 10

Warning Statements



Prior to the installation of this product, these installation instructions must be read and completely understood. Keep these installation instructions in an easily accessible location for future reference.



Proper installation procedure by a qualified service technician must be followed, as outlined in these installation instructions. Failure to do so could result in property damage, serious personal injury, or even death.



Safety measures must be practiced at all times during the assembly of this product. Use proper safety equipment and tools for the assembly procedure to prevent personal injury.



Premier Mounts does not warrant against damage caused by the use of any Premier Mounts product for purposes other than those for which it was designed or damage caused by unauthorized attachments or modifications, and is not responsible for any damages, claims, demands, suits, actions or causes of action of whatever kind resulting from, arising out of or in any manner relating to any such use, attachments or modifications.



At least two qualified people should perform the assembly procedure. Personal injury and/or property damage can result from dropping or mishandling your electronic equipment.



Be aware of the mounting environment. If drilling and/or cutting into the mounting surface, always make sure that there are no electrical wires in the wall. Cutting or drilling into an electrical line may cause serious personal injury.



Make sure there are no water or natural gas lines inside the wall where the mount is to be located. Cutting or drilling into a water or gas line may cause severe property damage or personal injury.



This product is intended for indoor use only. Use of this product outdoors could lead to product failure and/or serious personal injury.



Do not install near sources of high heat. Do not install on a structure that is prone to vibration, movement or chance of impact.











Contact Premier Mounts with any questions:
(800) 368-9700
techsupport@mounts.com

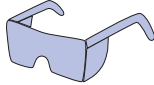

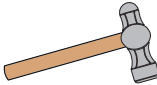

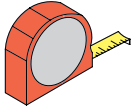
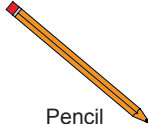

Installation Tools

The following tools may be required depending upon your particular installation. They are not included.

 Hand Held Drill	 3/8" Drill Bit	 Level	 Protective Eyewear
 18 AWG Wire Stripper	 Hammer	 Ladder	 #1 Phillips Tip Screwdriver
 #2 Phillips Tip Screwdriver	 Tape Measure	 Pencil	

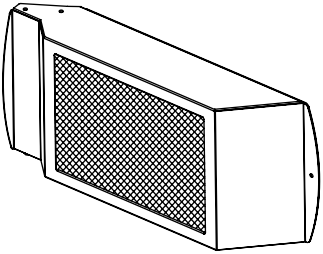
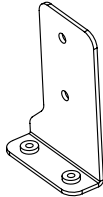
Parts List

Make sure your Premier Mounts product has the following hardware and components before beginning installation. If there are parts missing and/or damaged, stop the installation and call Premier Mounts at (800) 368-9700.

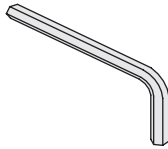
Speaker Hardware			
 On-Wall Speaker (Qty 2)	 CPA-50 Compact Power Amp Support Bracket (Qty 1)		
 M5 Drywall Anchors (Qty 2)	 M4 x 6mm Lock-It™ Security Screw (Qty 2)	 4-40 x 1/4" Phillips Flathead Screw (Qty 2)	 M5 Security Allen Wrench (Qty 1)



Features

The UNI-SPKR bundle provides the perfect audio solution for a classroom or meeting room environment. With 5.25" woofers and directional tweeters, the two 80/100W speakers deliver clear, dynamic sound for all purposes, including lectures and multimedia presentations. The on-wall speaker enclosures are tuned and ported before they leave the factory. UNI-SPKR fits into the Premier Mounts GearBox™ Audio Mount or UNI series of short-throw projector arm mounts.

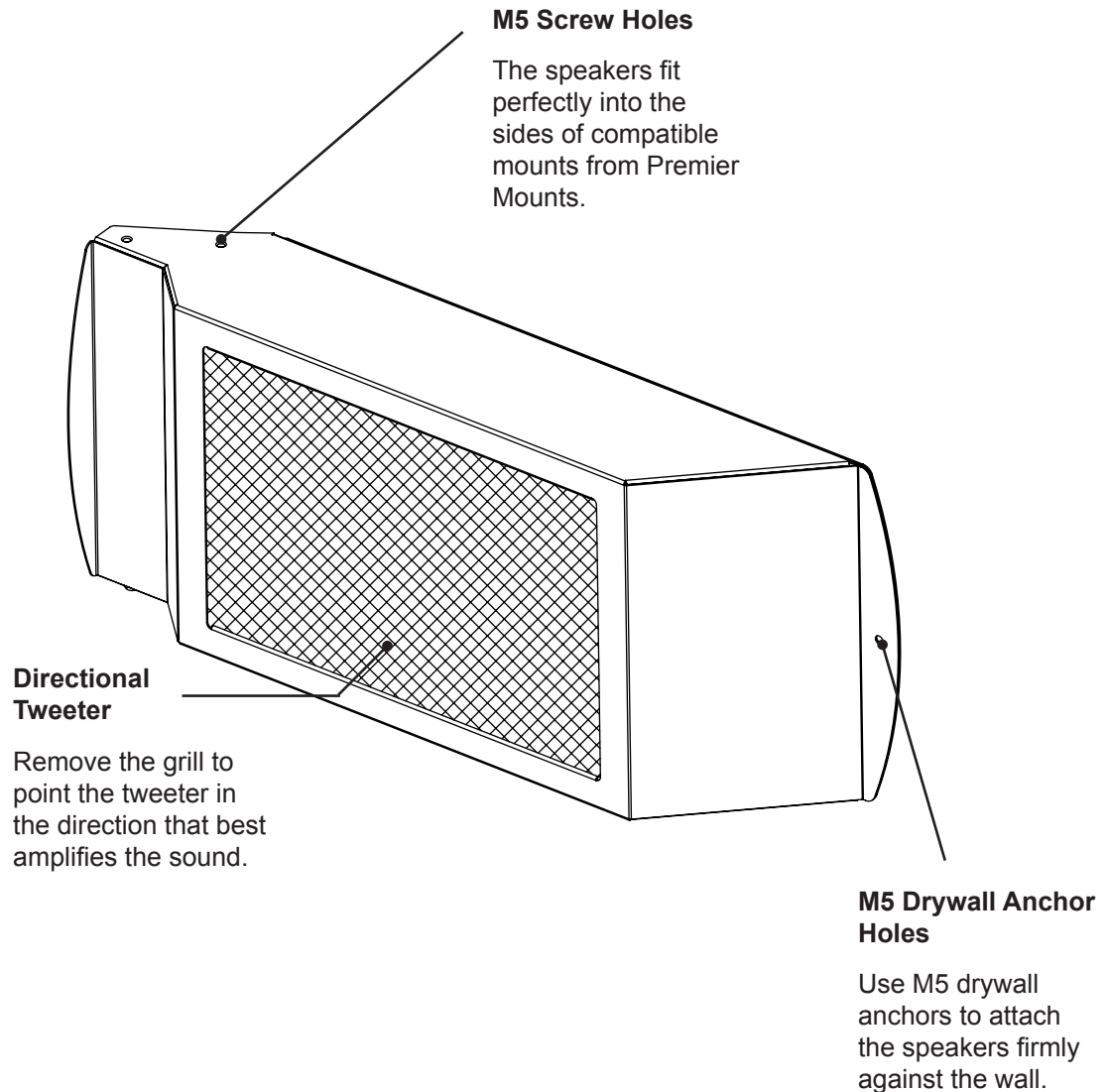



Installing the On-Wall Speakers

Introduction

The Premier Mounts On-Wall Speakers are designed for use with Premier Mounts' Universal Short-Throw Projector Arm Mounts, Universal Digital Signage Mounts and GearBox™ Audio Mounts. All parts, metal plates, screws, and bolts required to complete the assembly are provided with the speakers. Please read through the safety instructions before installation.



The CPA-50 Compact Power Amp is sold separately.

Wiring

Step 1



Strip the speaker wires evenly and split the positive and negative wires first, if needed. Keep exposed wire ends short after stripping. If the speaker wires touch, they may short the amplifier.



If you are connecting the sound sources directly to the projector, follow the suggested Option A wiring diagram (Figure 1) for reference.

If you are connecting the sound sources directly to the CPA-50 Power Amp and are using the external volume control, follow the suggested Option B wiring diagram (Figure 2) and 10k Pot Volume Diagram (Figure 3) for reference.



Are you replacing the speaker wires?

If **Yes**, continue to **Step 2** on page 6.

If **No**, go to **Step 3** on page 6.

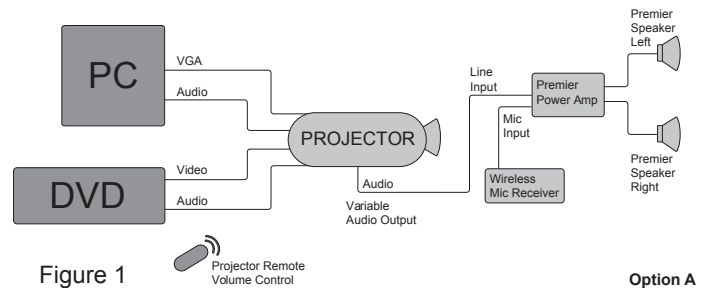

Option A

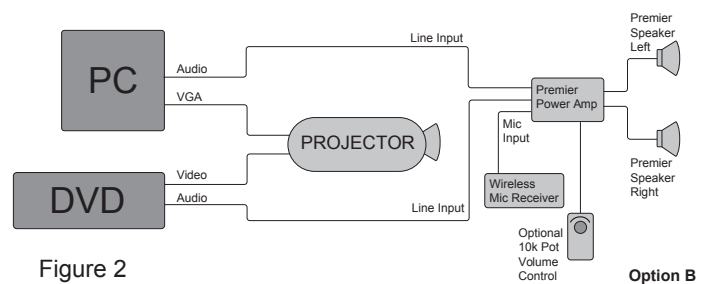

Option B

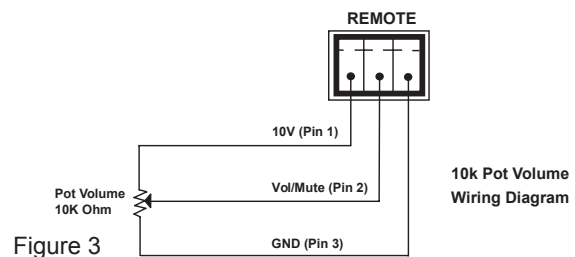

10k Pot Volume Wiring Diagram

**Step 2**

The UNI-SPKR kit comes with 18 AWG speaker wires pre-installed. If you would like to replace the wires, follow these instructions.



- 1 Remove the six (6) 4-40 x 1/4" Phillips flathead screws from each back cover of the speakers.
- 2 Remove the back covers, gaskets and old wires from the speakers.
- 3 Use an 18 AWG wire stripper to strip off the insulation from the new speaker wires by 3/16".
- 4 For each new wire, twist the ends of the wire strands together.
- 5 Attach the new speaker wires to the speaker terminals.
- 6 Knot each pair of speaker wires just inside the inner slots in the speaker housing.

 This will prevent the wires from accidentally pulling out when you attach them to the amp.

- 6 Thread the wires through the inner slots of the speaker housing (see drawing).
- 7 Re-attach the gaskets and back covers with the back cover screws.

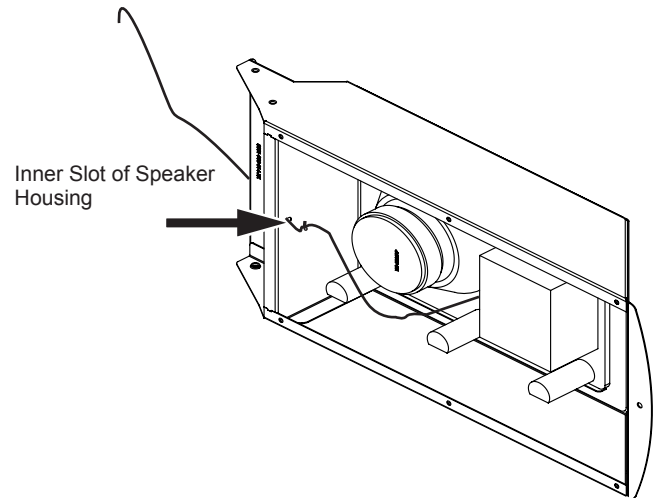
 Do not overtighten the back cover screws.

**Step 3**

- 1 Insert the four wires from the speakers into the blue 4-pin captive screw plug supplied with the power amp.
 -  Use a #1 Phillips screwdriver to tighten the locking screws.
 -  Match the wiring polarity. For example, red for positive, black or white for negative.
 -  Make sure no wire strand bridges (shorts) the adjacent terminals.
- 2 Insert the captive screw plug into the receptacle on the amp's rear panel (see drawing).

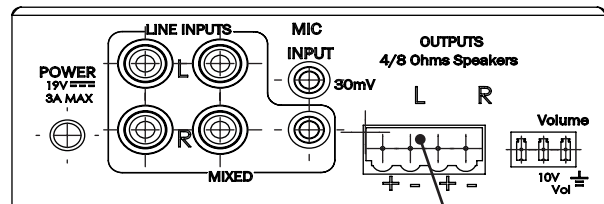

Amp Receptacle for the Captive Screw Plug

Proceed to the **“Installing the Power Amp (sold separately)”** section.



Installing the Power Amp (sold separately)

- 1 Use two (2) 4-40 x 1/4" Phillips flathead screws to attach the CPA-50 power amplifier to the small amp bracket.
- 2 Place the power amplifier inside the GearBox™ (see drawing).
- 3 Use two (2) M4 x 6mm Lock-It™ security screws to attach the power amplifier and small amp bracket to the inside bottom of the mount.
- 4 Attach the power amp plug to the amplifier.

Proceed to the "Attaching Speakers to the GearBox™" section below.

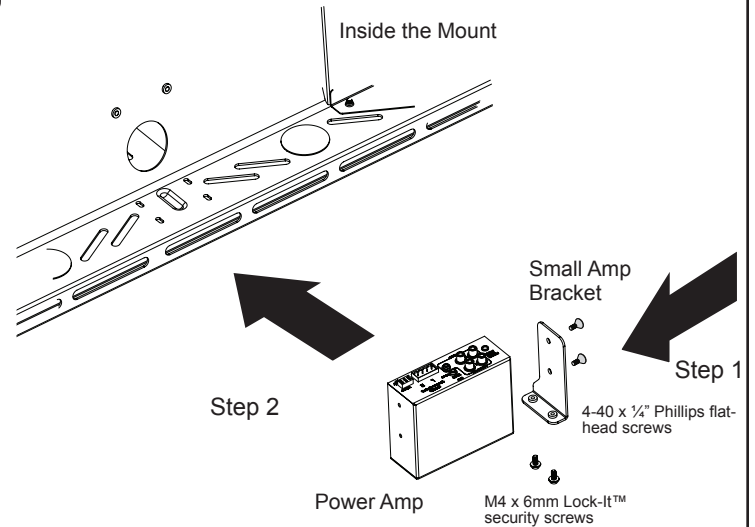

Attaching Speakers to the GearBox™

Step 1

 These instructions assume the GearBox™ mount is attached to the wall. See installation instructions for the mount if needed.

- 1 Remove the (4) M5 x 8mm security head screws from the side doors on the mount's wall plate (Figure 1).
- 2 Remove the side doors.
- 3 Insert the speakers into the sides of the mount (Figure 2).

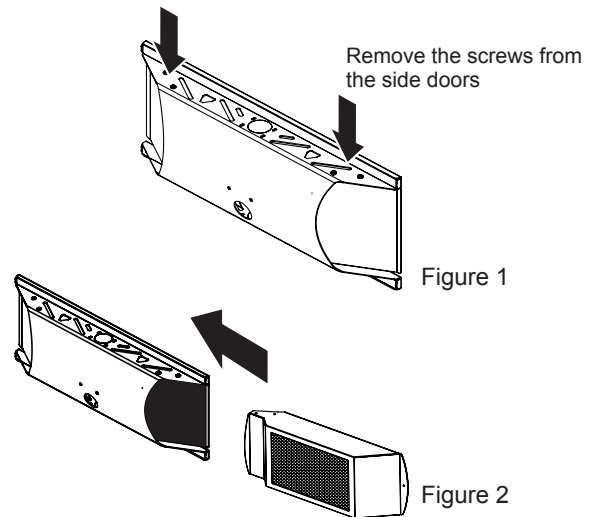

Step 2

- 1 Mark the holes on the outside edges of the mount's speakers where you will drill the drywall.

 The holes are for attaching M5 drywall anchors.

- 2 Remove the speakers.
- 3 Drill the drywall using a 3/8" drill bit where you made the marks.

Proceed to **Step 3** on page 8.

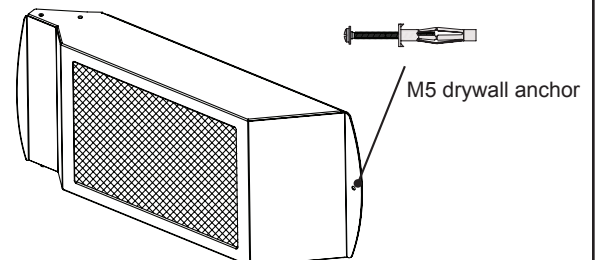

**Step 3**

- ❶ Insert and lightly hammer in two (2) M5 drywall anchors into the drilled holes (see drawing).
- ❷ Use a Phillips screwdriver to tighten each drywall anchor until the legs have completely compressed against the back of the wall.
- ⚠ Do not overtighten the drywall anchor.
- ❸ Remove the drywall anchor screws and set them aside.
- ❹ Return the speakers to their original position on the wall so that the outer speaker holes align with the drywall anchor sleeves.
- ❺ Insert the drywall anchor screws into an outer speaker hole and a drywall anchor sleeve.
- ❻ Use a #2 Phillips screwdriver to tighten each drywall anchor screw until it is snug.
- ⚠ Do not overtighten the drywall anchor screws.
- ❼ Use the (4) M5 x 8mm security head screws from the side doors to attach the speakers to the mount.

Proceed to the “**Aiming the Speakers**” section below.

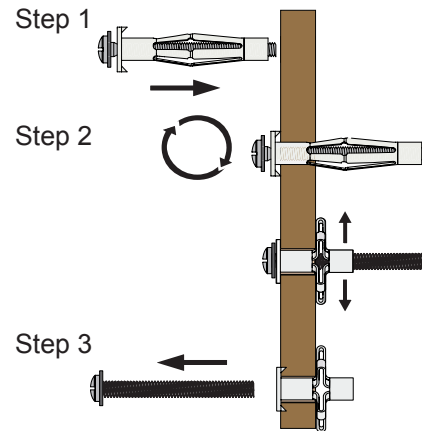
**Aiming the Speakers (optional)**

The speaker tweeters by default are set to the center position. Centered tweeters are ideal for most room configurations. If you want to adjust the tweeter alignment, see the instructions below.

- ❶ Bend a paper clip into a hook.
- ❷ Gently hook one of the grill holes at the corner of a speaker.
- ❸ Pull the grill out with the hook.
- ❹ Place your thumbs on the opposite edges of the tweeter.
- ❺ Push an edge of the tweeter to the desired direction.
-  For example, aim the tweeter towards the middle seat of the last row in the classroom or conference room.
- ❻ Repeat steps 1-5 for the other speaker.
- ❼ Play audio at the desired sound volume through the speakers.
- ❽ Walk around the room and note if there are significant sound differences in different places.
- ❿ **?** Is the sound level in the front of the room much louder than the back of the room?
If **Yes**, tilt the tweeters slightly higher.
If **No**, continue to the next question.
- ⓫ **?** Is the sound unclear from the sides of the room?
If **Yes**, slightly pan the tweeters outward.
If **No**, continue to step 9.
- ⓬ When you are satisfied with the sound, re-attach the speaker grills.



Technical Specifications

All measurements are in inches [mm].

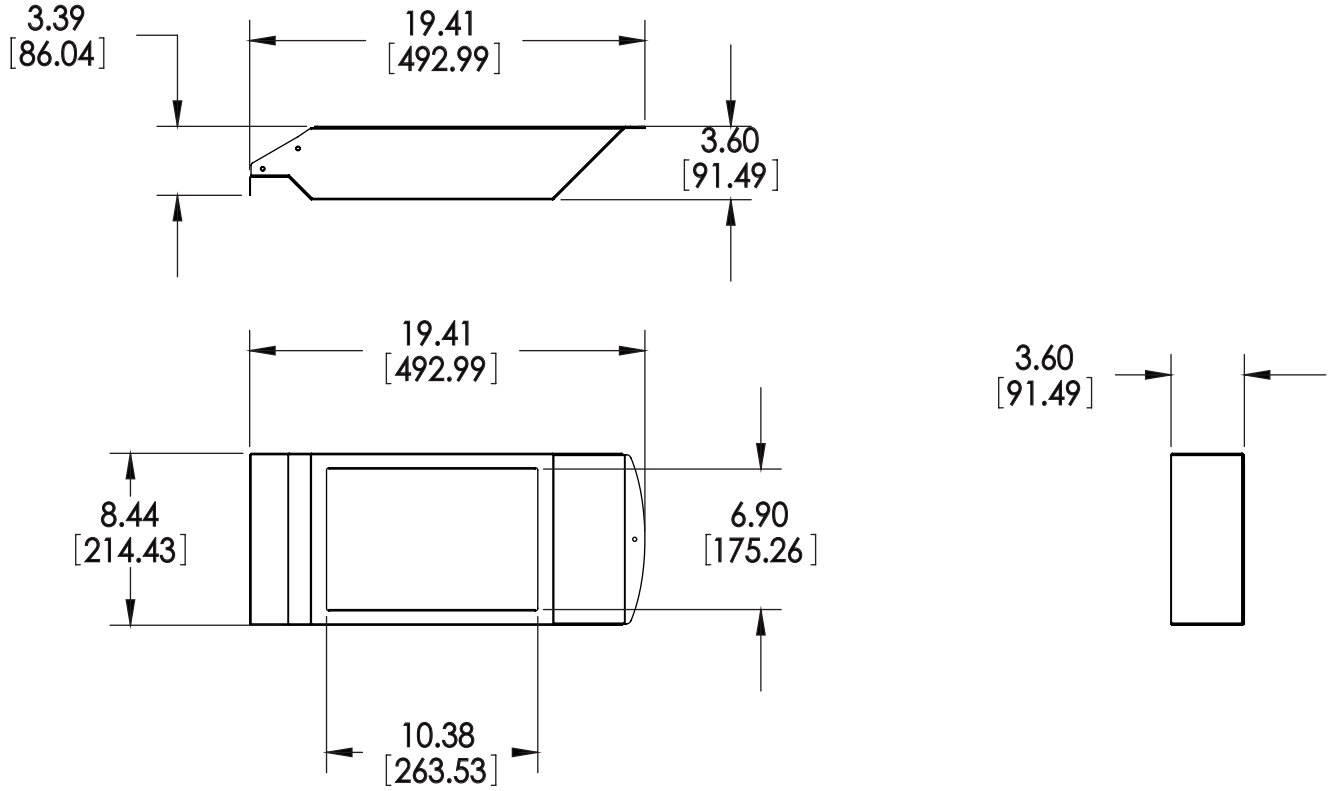



Warranty

PREMIER MOUNTS LIMITED 3-YEAR LIMITED WARRANTY

What and Who is Covered by this Limited 3-Year Warranty and for How Long

Premier Mounts warrants this product to be free from defects in material and workmanship for three years after the purchase of this product. The limited warranty is valid only for the original purchaser of the product.

What Premier Mounts Will Do

At the sole option of Premier Mounts, Premier Mounts will repair or replace any product or product part that is defective. If Premier Mounts chooses to replace a defective product or part, a replacement product or part will be shipped to you at no charge, but you must pay any labor costs.

What is Not Covered; Limitations

PREMIER MOUNTS DISCLAIMS ANY LIABILITY FOR DAMAGE TO MOUNTS, ADAPTERS, DISPLAYS, PROJECTORS, OTHER PROPERTY, OR PERSONAL INJURY RESULTING, IN WHOLE OR IN PART, FROM IMPROPER INSTALLATION, MODIFICATION, USE OR MISUSE OF ITS PRODUCTS.

PREMIER MOUNTS DISCLAIMS ALL OTHER WARRANTIES, EXPRESS OR IMPLIED, INCLUDING WARRANTIES OF MERCHANTABILITY AND FITNESS FOR A PARTICULAR PURPOSE. PREMIER MOUNTS IS NOT RESPONSIBLE FOR INCIDENTAL OR CONSEQUENTIAL DAMAGES, INCLUDING BUT NOT LIMITED TO, INABILITY TO USE ITS PRODUCTS OR LABOR COSTS FOR REMOVING AND REPLACING DEFECTIVE PRODUCTS OR PARTS. SOME STATES DO NOT ALLOW THE EXCLUSION OR LIMITATION OF INCIDENTAL OR CONSEQUENTIAL DAMAGES, SO THE ABOVE LIMITATION OR EXCLUSION MAY NOT APPLY TO YOU.

What Customers Must Do for Limited Warranty Service

If you discover a problem that you think may be covered by the warranty you MUST REPORT it in writing to the address below within thirty (30) days. Proof of purchase (an original sales receipt) from the original consumer purchaser must accompany all warranty claims. Warranty claims must also include a description of the problem, the purchaser's name, address, and telephone number. General inquiries can be addressed to Premier Mounts Customer Service at 1-800-368-9700. Warranty claims will not be accepted over the phone or by fax.

Premier Mounts
Attn: Warranty Claim
3130 East Miraloma Ave.
Anaheim, CA 92806

How State Law Applies

THIS WARRANTY GIVES YOU SPECIFIC LEGAL RIGHTS, AND YOU MAY ALSO HAVE OTHER RIGHTS WHICH VARY FROM STATE TO STATE.

Disclaimer

Premier Mounts intends to make this manual accurate and complete. However, Premier Mounts makes no claim that the information contained herein covers all details, conditions or variations, nor does it provide for every possible contingency in connection with the installation or use of this product. The information contained in this document is subject to change without notice or obligation of any kind. Premier Mounts makes no representation of warranty, expressed or implied, regarding the information contained herein. Premier Mounts assumes no responsibility for accuracy, completeness or sufficiency of the information contained in this document.