

LCD TV
User's Manual

NEC

E657Q



E327

E437Q

E507Q

E557Q

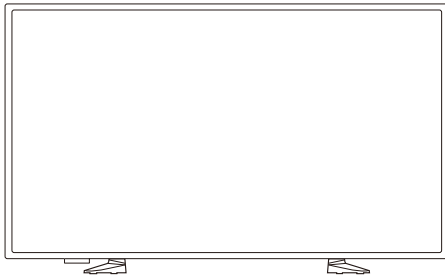







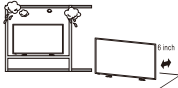
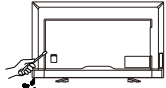

Please find your model name in the label on the backside of monitor.

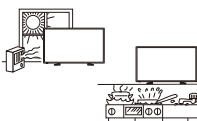
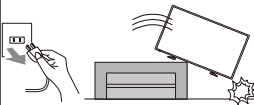
Index

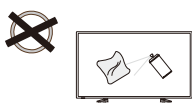
Precautions And Reminders	English-1
Important Safety Instructions	English-2
Important Information	English-5
License Notice and Trademark Acknowledgement.....	English-10
Supplier's Declaration of Conformity	English-11
Contents	English-14
Preparation	English-15
Attaching the Base.....	English-15
Using Cable Clamper	English-16
Preparing Your LCD TV For Wall Mounting (optional)	English-16
Prohibit Portrait Condition Use.....	English-17
Place The TV On A Solid Surface	English-18
Antenna Connection	English-18
Battery Installation and Replacement	English-19
Connect To The Power Source	English-20
Power On/Off Your New LCD TV	English-21
Power Mode Status.....	English-21
Source Connection Guide.....	English-24
Using The Remote Control.....	English-27
Operating Range for the Remote Control	English-28
Timing Table.....	English-29
Navigating The On-Screen Menu	English-30
Video Menu	English-30
Audio Menu	English-31
Channels Menu	English-32
Setup Menu.....	English-32
Control Settings Menu	English-35
USB Menu.....	English-35
Scheduling Menu	English-39
Maintenance and Recycling	English-40
Care Of The Screen	English-40
Mobile Telephone Warning.....	English-40
End Of Life Directives	English-40
Manufacturer's Recycling and Energy Information.....	English-41
Disposing of your old NEC product.....	English-41
Energy Saving.....	English-41
Product Specification.....	English-42
Controlling the LCD TV via RS-232C Remote Control.....	English-52
Controlling the LCD TV via LAN Control	English-54
Connecting to a Network.....	English-54
Network Setting by Using an HTTP Browser	English-54
Supporting HDMI CEC command.....	English-56
Before Calling Service.....	English-57
Glossary	English-58
[Notice] About the MPEG-4 AVC, MPEG-4 Visual license included in this product.....	English-59
GPL/LGPL Software Licenses Used by the Product	English-60

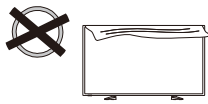
Precautions And Reminders

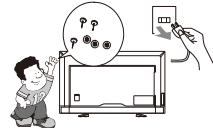
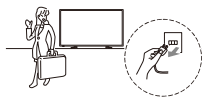
<p>Do not place the TV in confined spaces or in a box when in use. Maintain ample ventilation for the TV when in use.</p> 	<p>Do not open the TV cabinet.</p> 	<p>Call a NEC certified service personnel for any internal service needed for your TV.</p> 
<p>Keep the TV away from direct sunlight, dust, humidity, smoke and oily areas.</p> 	<p>Unplug immediately if the TV falls.</p> 	<p>Unplug immediately if there is a TV malfunction such as a loss of audio / video, the presence of smoke, or a bad odor coming from the TV.</p> 
<p>Unplug the AC cord from the AC outlet before cleaning. Do not use liquid cleaners or aerosol cleaners to clean the TV.</p> 	<p>Do not place the TV near water such as a bathtub, washbasin, sink, laundry tub, swimming pool, or a damp basement. Unplug immediately if the TV has been exposed to rain or water.</p> 	<p>Do not cover or block any vents or openings. Inadequate ventilation may shorten the life of the TV and cause overheating.</p> 
<p>Place the unit on a sturdy, even surface.</p> 	<p>Do not insert any foreign objects into the TV cabinet. Unplug immediately if objects have fallen into the monitor.</p> 	<p>Unplug the power cord from the outlet when the TV is not in use for long periods of time (days).</p> 



Notice for Remote Controller

<p>Avoid Liquids</p> 	<p>Avoid Aerosol Cleaners</p> 	<p>Avoid Dropping</p> 
--	---	---

Important Safety Instructions

Read before operating equipment

Follow all warnings and instructions marked on this TV.

1. Read these instructions.
2. Keep these instructions.
3. Heed all warnings.
4. Follow all instructions.
5. Do not use this apparatus near water.
6. Clean only with dry cloth.
7. Do not block any ventilation openings. Install in accordance with the manufacturer's instructions.
8. Do not install near any heat sources such as radiators, heat registers, stoves, or other apparatus (including amplifiers) that produce heat.
9. Do not defeat the safety purpose of the polarized or grounding-type plug. A polarized plug has two blades with one wider than the other. A grounding type plug has two blades and a third grounding prong. The wide blade or the third prong are provided for your safety. If the provided plug does not fit into your outlet, consult an electrician for replacement of the obsolete outlet.
10. Protect the power cord from being walked on or pinched particularly at plugs, convenience receptacles, and the point where they exit from the apparatus.
11. Only use attachments / accessories specified by the manufacturer.
12. Use only with the cart, stand, tripod, bracket, or table specified by the manufacturer, or sold with the apparatus. When a cart is used, use caution when moving the cart/apparatus combination to avoid injury from tip-over.



13. Unplug this apparatus during lightning storms or when unused for long periods of time.
14. Refer all servicing to qualified service personnel. Servicing is required when the apparatus has been damaged in any way, such as power-supply cord or plug is damaged, liquid has been spilled or objects have fallen into the apparatus, the apparatus has been exposed to rain or moisture, does not operate normally, or has been dropped. Unplug immediately if the monitor faces above condition.
15. The TV complies with the recommended safety standards for stability. Do not put excessive force on the front or top of the cabinet. This could cause the product to tip over and cause damage and / or personal injury.
16. If monitor or glass is broken, do not come in contact with the liquid crystal and handle with care.

17. Follow instructions for wall, shelf or ceiling mounting as recommended by the manufacturer.
18. An outdoor antenna should not be located near overhead power lines or any electrical circuits.
19. If an outside antenna is connected to the receiver, confirm that the antenna system is grounded to protect against voltage surges and built up static charges. Section 810 of the National Electric Code, ANSI / NFPA No. 70-1984, provides information with respect to proper grounding for the mast and supporting structure, grounding of the lead-in wire to an antenna discharge unit, size of grounding connectors, location of antenna discharge unit, connection to grounding electrodes and requirements for the grounding electrode.
The cable distribution system should be grounded (earthed) in accordance with ANSI/NFPA 70. the National Electrical Code (NEC), in particular Section 820.93, Grounding of Outer Conductive Shield of a Coaxial Cable.
20. Rest your eyes periodically by focusing on an object at least 5 feet away. Blink often.
21. Do not place any heavy objects on the power cord.
Damage to the cord may cause shock or fire.
22. Do not use monitor in high temperature, humid, dusty, or oily areas.
23. Do not bend, crimp or otherwise damage the power cord.
24. Apparatus shall not be exposed to dripping or splashing and no objects filled with liquids, such as vases, shall be placed on the apparatus.

NOTE: To the TV system installer: This reminder is provided to call attention to Article 820-44 of the National Electric Code that provides guidelines for proper grounding and, in particular, specifies that the cable ground shall be connected to the grounding system of the facility, as reasonably close to the point of cable entry as possible

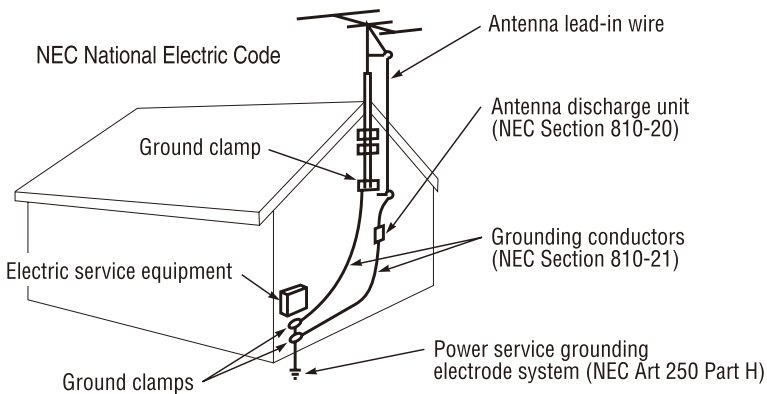



WARNING - Stability Hazard

A television set may fall, causing serious personal injury or death. Many injuries, particularly to children, can be avoided by taking simple precautions such as:

- ALWAYS use cabinets or stands or mounting methods recommended by the manufacturer of the television set.
- ALWAYS use furniture that can safely support the television set.
- ALWAYS ensure the television set is not overhanging the edge of the supporting furniture.
- ALWAYS educate children about the dangers of climbing on furniture to reach the television set or its controls.
- ALWAYS route cords and cables connected to your television so they cannot be tripped over, pulled or grabbed.
- NEVER place a television set in an unstable location.
- NEVER place the television set on tall furniture (for example, cupboards or bookcases) without anchoring both the furniture and the television set to a suitable support.
- NEVER place the television set on cloth or other materials that may be located between the television set and supporting furniture.
- NEVER place items that might tempt children to climb, such as toys and remote controls, on the top of the television or furniture on which the television is placed.

If the existing television set is going to be retained and relocated, the same considerations as above should be applied.



WARNING:

To prevent injury, this apparatus must be securely attached to the floor/wall in accordance with the installation instructions.

Important Information



WARNING



TO PREVENT FIRE OR SHOCK HAZARDS, DO NOT EXPOSE THIS UNIT TO RAIN OR MOISTURE. ALSO, DO NOT USE THIS UNIT'S POLARIZED PLUG WITH AN EXTENSION CORD RECEPTACLE OR OTHER OUTLETS UNLESS THE PRONGS CAN BE FULLY INSERTED. REFRAIN FROM OPENING THE CABINET AS THERE ARE HIGH VOLTAGE COMPONENTS INSIDE.
REFER SERVICING TO QUALIFIED SERVICE PERSONNEL.



CAUTION



CAUTION: TO REDUCE THE RISK OF ELECTRIC SHOCK, MAKE SURE POWER CORD IS UNPLUGGED FROM WALL SOCKET. TO FULLY DISENGAGE THE POWER TO THE UNIT, PLEASE DISCONNECT THE POWER CORD FROM THE AC OUTLET. DO NOT REMOVE COVER (OR BACK). NO USER SERVICEABLE PARTS INSIDE. REFER SERVICING TO QUALIFIED SERVICE PERSONNEL.



This symbol warns user that uninsulated voltage within the unit may have sufficient magnitude to cause electric shock. Therefore, it is dangerous to make any kind of contact with any part inside this unit.



This symbol alerts the user that important literature concerning the operation and maintenance of this unit has been included. Therefore, it should be read carefully in order to avoid any problems.



CAUTION:

Please use the power cord provided with this TV in accordance with the table below. If a power cord is not supplied with this equipment, please contact your supplier.

Plug Type	Plug Shape	Region	Voltage
North America		U.S.A./Canada	AC 120 V

Power source

This LCD TV operates on 120 volts 60 Hz, AC current. Insert the power cord into a 120 volts 60 Hz outlet. The mains plug is used as the disconnect device and shall remain readily operable.

To prevent electric shock from the TV, do not use with an extension cord, receptacle, or other outlet unless the blades and ground terminal can be fully inserted to prevent blade exposure.

Never connect the LCD TV to 50 Hz, direct current, or anything other than the specified voltage.



CAUTION:

Never remove the back cover of the LCD TV as this can expose you to very high voltages and other hazards. If the TV does not operate properly, unplug the LCD TV and call your authorized dealer or service center.

Adjust only those controls that are covered in the instructions, as improper changes or modifications not expressly approved by NEC could void the user's warranty.

Batteries installed warning



CAUTION:

Incorrect usage of batteries can result in leaks or bursting.

NEC recommends the following battery use:

- Do not mix battery brands.
- Danger of explosion if battery is incorrectly replaced. Replace only with the same or equivalent type.
- Do not combine new and old batteries. This can shorten the battery life or cause liquid leakage of the batteries.
- Remove dead batteries immediately to prevent battery acid from leaking into the battery compartment.
- Do not touch exposed battery acid as it may injure skin.
- Remove the batteries if you do not intend to use the remote control for a long period of time.
- The batteries shall not be exposed to excessive heat such as sunshine, fire or the like.

Image persistence

- Please be aware that LCD Technology may experience a phenomenon known as Image Persistence.

Image Persistence occurs when a residual or “ghost” image of a previous image remains visible on the screen.

Unlike CRT monitors, LCD monitors’ image persistence is not permanent, but constant images being displayed for a long period of time should be avoided.

To alleviate image persistence, turn off the monitor for as long as the previous image was displayed.

For example, if an image was on the monitor for one hour and a residual image remains, the monitor should be turned off for one hour to erase the image.

NOTE: As with all personal display devices, NEC DISPLAY SOLUTIONS recommends displaying moving images and using a moving screen saver at regular intervals whenever the screen is idle or turning off the monitor when not in use.



CAUTION:

These servicing instructions are for use by qualified service personnel only. To reduce the risk of electric shock, do not perform any servicing other than that contained in the operating instructions unless you are qualified to do so.

Ventilation

The slots and openings in the TV are provided for necessary ventilation. To ensure reliable operation of the TV and to protect it from overheating, these slots and openings must never be blocked or covered.

Unless proper ventilation is provided, the TV may gather dust and get dirty.

For proper ventilation, observe the following:

- Do not install the TV face up, down or sideways.
- Do not install the TV turned over or upside down.
- Never cover the slots and openings with a cloth or other materials.
- Never block the slots and openings by placing the TV on a bed, sofa, rug or other similar surface.
- Never place the TV in a confined space, such as a bookcase or built-in cabinet, unless proper ventilation is provided.

Leave some space around the TV set as shown below. Otherwise, air-circulation may be inadequate and will cause overheating, which may cause a fire or damage to the TV set.

Install on the wall

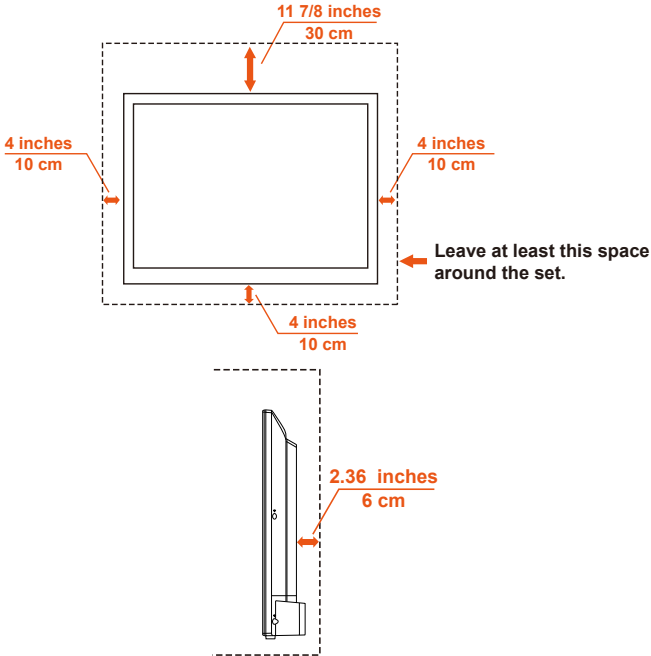

For use only with UL Listed Wall Mount Bracket with minimum weight / load: Please refer to the Specification on page 42 to page 51 .
Unit without base weight: The equipment and its associated mounting means still remain secure during the test.
Used wall mounting kit, VESA-compatible wall bracket distance, diameter of Screw dimension: Please refer to the Specification on page 42 to page 51 .

Installed with stand

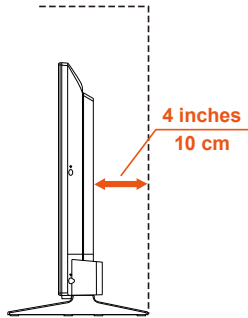
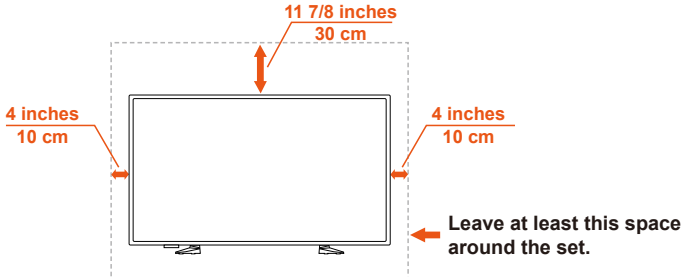

Never install the TV set where air-circulation is blocked.

Objects and ventilation holes

Never push objects of any kind into the TV through the cabinet slots as they may touch dangerous voltage points or short out parts that could result in a fire or an electric shock. Do not place any objects on the TV.

License Notice and Trademark Acknowledgement

Windows is a registered trademark of Microsoft Corporation.
NEC is a registered trademark of NEC Corporation.
All other brands and product names are trademarks or registered trademarks of their respective owners.



The terms HDMI and HDMI High-Definition Multimedia Interface, and the HDMI Logo are trademarks or registered trademarks of HDMI Licensing Administrator, Inc. in the United States and other countries.



Manufactured under license from Dolby Laboratories. Dolby, Dolby Audio and the double-D symbol are trademarks of Dolby Laboratories.

HDCP (High-bandwidth Digital Content Protection): HDCP is a system for preventing illegal copying of video data sent over a digital signal. If you are unable to view material via the digital input, this does not necessarily mean that the monitor is not functioning properly. With the implementation of HDCP, there may be cases in which certain content is protected by HDCP and might not be displayed due to the decision/intention of the HDCP community (Digital Content Protection, LLC).

CRESTRON and CRESTRON ROOMVIEW are trademarks or registered trademarks of Crestron Electronics, Inc. in the United States and other countries.

GPL/LGPL Software Licenses

The product includes software licensed under GNU General Public License (GPL), GNU Lesser General Public License (LGPL), and others.

Adobe and the Adobe logo are either registered trademarks or trademarks of Adobe Systems Incorporated in the United States and/or other countries.

Supplier's Declaration of Conformity

This device complies with Part 15 of FCC Rules. Operation is subject to the following two conditions. (1) This device may not cause harmful interference, and (2) this device must accept any interference received, including interference that may cause undesired operation.

U.S. Responsible Party:	NEC Display Solutions of America, Inc.
Address:	3250 Lacey Rd, Ste 500 Downers Grove, IL 60515
Tel. No.:	(630) 467-3000

Type of Product:	LCD TV	
Equipment Classification:	Class B Peripheral	
Model:	E657Q	E437Q
	E557Q	E327
	E507Q	



Canadian Department of Communications Compliance Statement

DOC: This Class B digital apparatus meets all requirements of the Canadian Interference-Causing Equipment Regulations.

C-UL: Bears the C-UL Mark and is in compliance with Canadian Safety Regulations according to CSA C22.2 No. 62368-1-14.

FCC Information:



WARNING:

The Federal Communications Commission does not allow any modifications or changes to the unit EXCEPT those specified by NEC Display Solutions of America, Inc. in this manual. Failure to comply with this government regulation could void your right to operate this equipment.

1. Use the attached specified cables with the E657Q / E557Q / E507Q / E437Q / E327 color monitor so as not to interfere with radio and television reception. Use of other cables and adapters may cause interference with radio and television reception.
 - (1) Please use the supplied power cord or equivalent to ensure FCC compliance.
 - (2) Please use the supplied shielded HDMI signal cable.
 - (3) For mini D-Sub 15-pin and USB , please use a shielded signal cable with ferrite core.
 - (4) For D-sub 9-pin and Coaxial , please use a shielded signal cable.
2. This equipment has been tested and found to comply with the limits for a Class B digital device, pursuant to part 15 of the FCC Rules. These limits are designed to provide reasonable protection against harmful interference in a residential installation. This equipment generates, uses and can radiate radio frequency energy and, if not installed and used in accordance with the instructions, may cause harmful interference to radio communications. However, there is no guarantee that interference will not occur in a particular installation. If this equipment does cause harmful interference to radio or television reception, which can be determined by turning the equipment off and on, the user is encouraged to try to correct the interference by one or more of the following measures:
 - Reorient or relocate the receiving antenna.
 - Increase the separation between the equipment and receiver.
 - Connect the equipment into an outlet on a circuit different from that to which the receiver is connected.
 - Consult the dealer or an experienced radio / TV technician for help.

If necessary, the user should contact the dealer or an experienced radio/television technician for additional suggestions.

The user may find the following booklet, prepared by the Federal Communications Commission, helpful: "How to Identify and Resolve Radio-TV Interference Problems." This booklet is available from the U.S. Government Printing Office, Washington, D.C., 20402, Stock No. 004-000-00345-4.



FCC CAUTION

To assure continued compliance and possible undesirable interference, ferrite cores may be used when connecting this LCD TV to video equipment; and maintain at least 400mm spacing to other peripheral device.

Cables

Connections to this device must be made with shielded cables with metallic RF / EMI connector hoods to maintain compliance with FCC Rules and Regulations.

Canadian notice

CAN ICES-3 (B) / NMB-3(B)

Analog and Digital Television Receiving Apparatus — Appareil de réception de télévision analogique et numérique, Canada BETS-7 / NTMR-7

If necessary, the user should contact the dealer or an experienced radio/television technician for additional suggestions. The user may find the following booklet, prepared by the Federal Communications Commission, helpful: "How to Identify and Resolve Radio-display Interference Problems." This booklet is available from the U.S. Government Printing Office, Washington, D.C., 20402, Stock No. 004-000-00345-4.

Contents

Your new NEC monitor box*1 should contain the following:

- Monitor (1)
- Remote control (1)
- 1.5 V AAA batteries (2)
- Power cord (1)
- HDMI cable (1)
- Setup manual (1)

E657Q / E557Q / E507Q / E437Q / E327



Wireless Remote Control
and AAA Batteries



Power Cord



HDMI Cable



Setup Manual

NOTE:

*1: Remember to save your original box and packing material to transport or ship the monitor.

*2: The following stand base and screw are option parts.

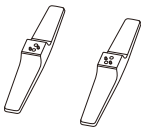

(E657Q)

Stand Base

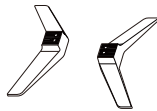

(E557Q/E507Q/E437Q/E327)



E657Q: M6 (25mm) x 4
E557Q / E507Q / E437Q: M4 (20mm) x 4
E327: M4 (20mm) x 4

Stand Screw

Preparation

IMPORTANT: Do not apply pressure to the TV screen display area which may compromise the integrity of the display. The manufacturer's warranty does not cover user abuse or improper installations.

Attaching the Base

E657Q

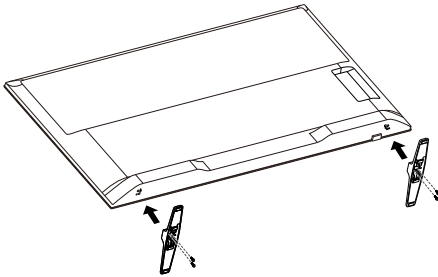

Stand Screw x 4
M6 (25mm)

E557Q / E507Q / E437Q / E327

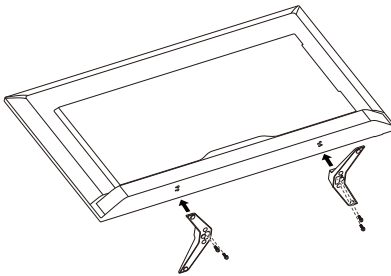

Stand Screw x 4
M4 (20mm)

1. Place the TV face down on a soft and flat surface to prevent scratching and damage.
2. Carefully align the base to the button of the TV and fasten the screws with a cross-head screwdriver.



CAUTION:

The base of the stand is very heavy. Install with care to avoid injury such as dropping the base onto one's foot.

Using Cable Clamper

Tie the cables together using the cable clamper.

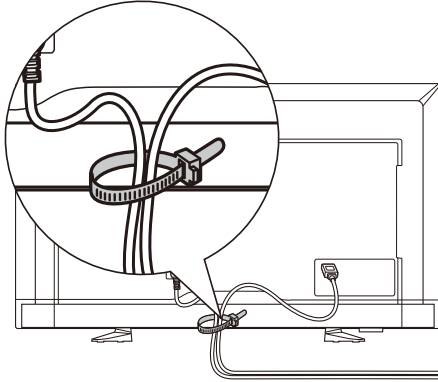

Preparing Your LCD TV For Wall Mounting (optional)

We suggest that you keep your TV at least 2.36 inches (60 mm) from the wall to prevent cable interference. Before mounting your TV on the wall, you need to remove the base. For your safety, only mount with a UL listed wall mount bracket that supports the weight of the TV. (Please see page 42 to page 51)

To attach a wall mount bracket to your TV:

E657Q

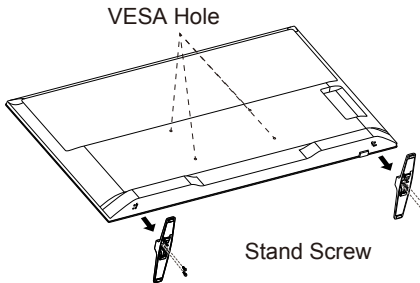

1. Loosen the screws on the bottom of the base, and remove the base.
2. Secure the wall mount bracket to the back of your TV using four M6 screws.

screen size (inches)	required pitch (mm)	VESA Hole depth
65	400 × 200	4 × M6 (17 mm)

NOTE:

Wall mounting solution is not included with the unit and is sold separately. Contact your NEC representative for details. It is necessary to provide screw of appropriate length (Wall mount bracket thickness + VESA Hole depth).

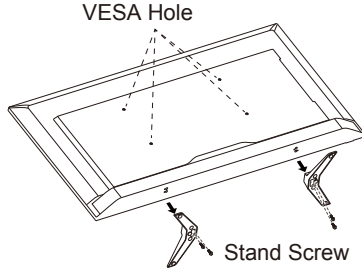

1. Loosen the screws on the button of the base, and remove the base.
2. Secure the wall mount bracket to the back of your TV using four M4 screws (for 32" only) or M6 screws (for 43"/50"/55").

screen size (inches)	required pitch (mm)	VESA Hole depth
55	400 × 200	4 × M6 (17 mm)
50	400 × 200	4 × M6 (17.5 mm)
43	200 × 200	4 × M6 (14.5 mm)
32	100 × 100	4 × M4 (16 mm)

NOTE:

Wall mounting solution is not included with the unit and is sold separately. Contact your NEC representative for details. It is necessary to provide screw of appropriate length (Wall mount bracket thickness + VESA Hole depth).

Prohibit Portrait Condition Use

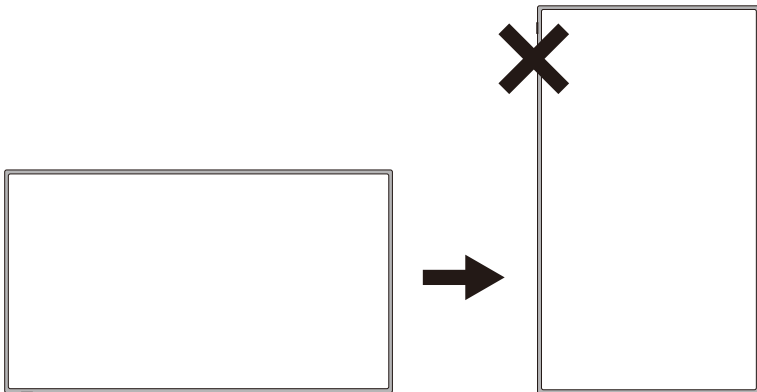

⚠ CAUTION:

Do not rotate the monitor from landscape to portrait.

Place The TV On A Solid Surface

Ensure that the LCD TV is placed in a position to allow free flow of air.

Do not cover the ventilation openings on the back cover.

Do not place the TV near any open flames.

Do not allow the TV to be placed in an environment where it can be exposed to heat, direct sunlight, or rain and water.

Do not expose the equipment to any liquid.

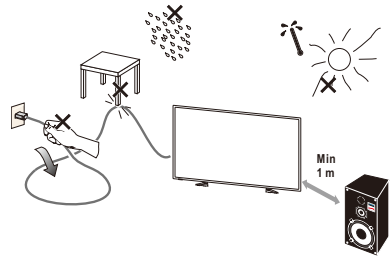

Antenna Connection

Unless your LCD TV is connected to a cable TV system or to a centralized antenna system, a good outdoor color TV antenna is recommended for best television performance. However, if you are located in an exceptionally good signal area that is free from interference and multiple image ghosts, an indoor antenna may be sufficient.

When using a 75-Ohm coaxial cable system, connect the CATV coaxial cable to the AIR/CABLE (75-Ohm) terminal. Or if you have an antenna, connect the coaxial cable to the same AIR/CABLE terminal.

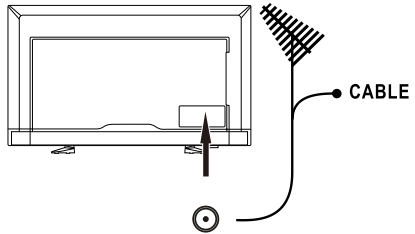

Battery Installation and Replacement

The remote control is powered by two 1.5V AAA batteries. To install or replace batteries:

1. Open the battery cover of the remote control by pushing and pulling it in the direction of the arrow.
2. Insert two new “AAA” size batteries for the remote control. When replacing old batteries, push them towards the springs and lift them out.
3. Match the batteries to the (+) and (-) marks in the battery compartment.
4. Insert the bottom of the battery, the (-) side, into the battery compartment first, push towards the springs and insert the top of the battery, the (+) side, into place. Do not force the battery into the battery compartment.
5. Close the battery cover making sure the tabs rest in the corresponding holes and push down the cover until it clicks shut.

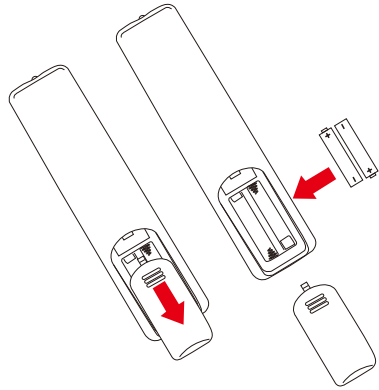

Connect To The Power Source

The TV should be installed close to an easily accessible power outlet. Fully insert the prongs into the power outlet socket. A loose connection may cause image degradation.

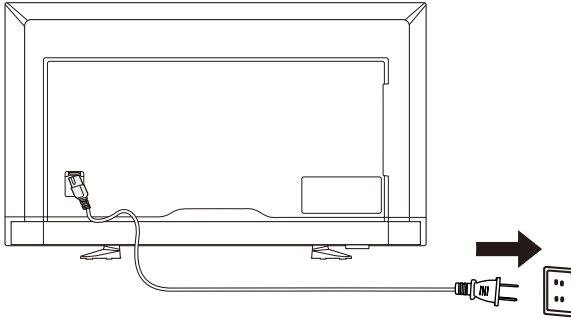

If there is power to the TV, the front LED at the bottom of the TV will be either none or red. A red LED means the TV is in Auto Standby mode.

Cable information



CAUTION:

Use the attached specified cables with the E657Q / E557Q / E507Q / E437Q / E327 color monitor so as not to interfere with radio and television reception.

Use of other cables and adapters may cause interference with radio and television reception.

- (1) Please use the supplied power cord or equivalent to ensure FCC compliance.
- (2) Please use the supplied shielded HDMI signal cable.
- (3) For mini D-Sub 15-pin and USB , please use a shielded signal cable with ferrite core.
- (4) For D-sub 9-pin and Coaxial , please use a shielded signal cable.

Power On/Off Your New LCD TV

Press the power button on the remote control or press the power button located on the side of the TV. The TV will power on.

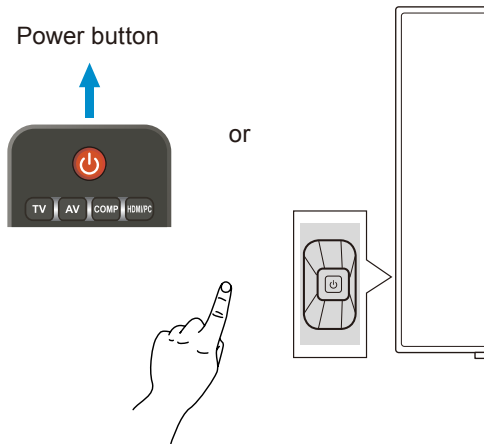

Power Mode Status

When in ON mode, the Monitor operates as follows if no external signal is input.

Mode	ON	Auto Power save	Auto Standby
LED Status	None	Blinking Red	Red

[1] **HOME setting is set under Energy Options and None setting is set under Input Detection and LAN setting is set under Control Interface in the on-screen display menu.**

- 1-1. When the external device is connected to the VGA terminal, the NO SIGNAL menu is displayed and 10 seconds later the Monitor switches to Auto Power save mode.
- 1-2. In Auto Power save mode at VGA terminal, when the Monitor receives a signal from an external VGA device, it switches automatically to ON mode. If LAN-LINK is lost and 3 minutes later the Monitor switches to Auto Standby mode.

NOTE:

Note that in Auto Power save mode at VGA terminal, the Monitor does not switch automatically to ON mode even if a signal is input from an external device using HDMI, component video or composite video.

If the power cord is unplugged during Auto Power save mode at VGA terminal, the Monitor will start in Auto Standby mode the next time it is turned on.

- 1-3. When the external device is connected to another terminal (HDMI,

component video, composite video), the NO SIGNAL menu is displayed and 10 seconds later the Monitor switches to Auto Power save mode.

- 1-4. For example, In Auto Power save mode at HDMI-1 terminal, when the Monitor receives a signal from an external HDMI-1 device, it switches automatically to ON mode. If LAN-LINK is lost and 3 minutes later the Monitor switches to Auto Standby mode.

NOTE:

For example, Note that in Auto Power save mode at HDMI-1 terminal, the Monitor does not switch automatically to ON mode even if a signal is input from an external device using VGA, HDMI-2, HDMI-3, component video or composite video.

If the power cord is unplugged during Auto Power save mode at at HDMI-1, HDMI-2, HDMI-3, component video or composite video terminal, the Monitor will starts in Auto Standby mode the next time it is turned on.

[2] RETAIL setting is set under Energy Options and None setting is set under Input Detection and LAN setting is set under Control Interface in the on-screen display menu.

- 2-1. When the external device is connected to the VGA, HDMI, component video, composite video terminal, the NO SIGNAL menu is displayed. The monitor keeps ON mode.
- 2-2. For example, In ON mode at HDMI-1 terminal, when the Monitor receives a signal from an external HDMI-1 device, The monitor disappear NO SIGNAL menu and displays contents.

NOTE:

The monitor keeps ON mode during RETAIL setting, so, RETAIL setting is a relatively more energy consuming mode.

[3] OFFICE setting is set under Energy Options and None setting is set under Input Detection and LAN setting is set under Control Interface in the on-screen display menu.

- 3-1. When the external device is connected to the VGA terminal, the NO SIGNAL menu is displayed and 10 seconds later the Monitor switches to Auto Power save mode.
- 3-2. In Auto Power save mode at VGA terminal, when the Monitor receives a signal from an external VGA device, it switches automatically to ON mode.
- 3-3. For example, In Auto Power save mode at signal lost condition, when the display does not receive a Link signal from LAN terminal, the display still keeps Auto Power save mode.

NOTE:

Note that in Auto Power save mode at VGA terminal, the Monitor does not switch automatically to ON mode even if a signal is input from an external device using HDMI, component video or composite video.

If the power cord is unplugged during Auto Power save mode at VGA terminal, the Monitor will starts in Auto Standby mode the next time it is turned on.

- 3-4. When the external device is connected to another terminal (HDMI, component video, composite video), the NO SIGNAL menu is displayed and 10 seconds later the Monitor switches to Auto Power save mode.
- 3-5. For example, In Auto Power save mode at HDMI-1 terminal, when the Monitor receives a signal from an external HDMI-1 device, it switches automatically to ON mode.
- 3-6. For example, In Auto Power save mode at signal lost condition, when the display does not receive a Link signal from LAN terminal, the display still keeps Auto Power save mode.

NOTE:

For example, Note that in Auto Power save mode at HDMI-1 terminal, the display does not switch automatically to ON mode even if a signal is input from an external device using VGA, HDMI-2, HDMI-3, component video or composite video.

If the power cord is unplugged during Auto Power save mode at HDMI-1, HDMI-2, HDMI-3, component video or composite video terminal, the display will start in Auto Standby mode the next time it is turned on.

NOTE:

When switching setting (Home/Retail/Office) under Energy Options function, the setting values in Video Menu return to default value.

Also, if Retail mode is set under Energy Options function, the setting values in Video Menu return to default value after turning On/Off by the AC power supply, switching On/Off by the power button on remote control or on the side of the monitor.

Source Connection Guide

E657Q

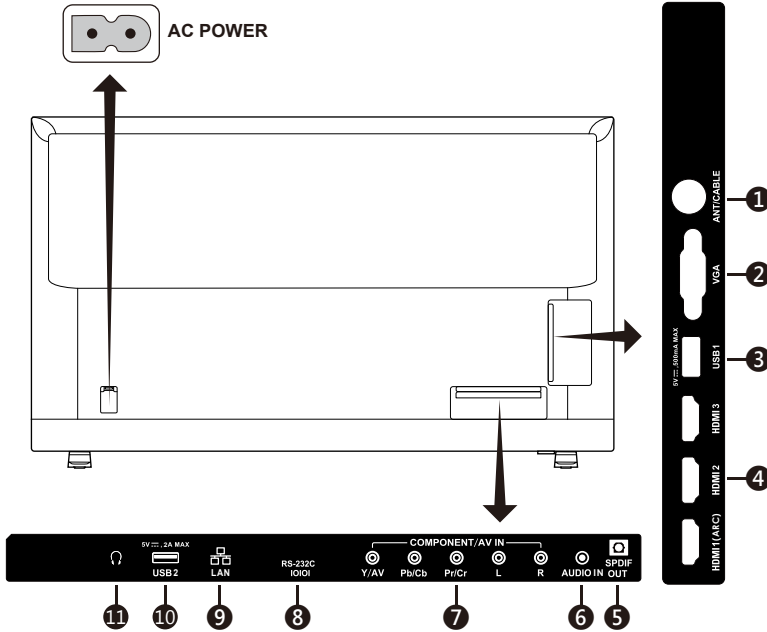

1. **ANT / CABLE** – Connect to an RF antenna or Analog Cable system.
2. **VGA** – Connect to your PC video.
3. **USB 1 port** – Used for accessing photo, music, and movie files. Please make sure the connector shape and orientation is correctly aligned when connecting the USB device or cable.
4. **HDMI (HDMI-1, HDMI-2, HDMI-3)** – Connect to your HDMI devices. HDMI-1 terminal can support ARC (Audio Return Channel) function. ARC output does not work sound effect (Sound mode, Balance, Bass, Treble on OSD).
5. **SPDIF OUT-** Use a digital audio cable to connect to stereo home theater system. SPDIF output does not work sound effect (Sound mode, Balance, Bass, Treble on OSD). SPDIF output does not work Auto function of Internal Speakers on OSD.
6. **AUDIO IN** – Connect to your PC audio.
7. **COMPONENT / AV IN** –
 - Component: Connect to digital video equipment to the Video Green (Y), Blue (Pb), Red (Pr) jacks, and matching Audio White (L) and Red (R) jacks.
 - Composite: Connect to digital video equipment to the Video Green (AV), jacks, and matching Audio White (L) and Red (R) jacks.
8. **RS-232C** – Connect to your PC, and receive the control commands from

the PC.

9. **LAN port (RJ-45)**– LAN connection.
10. **USB 2 port** – Power supply port 5V/2A (maximum)
Please make sure the connector shape and orientation is correctly aligned when connecting the USB device or cable. When you use the USB (2A) port for power supply, please use a USB cable that supports 2A.
Do not bind the USB cable. It may cause heat or fire.
11. **Headphone** – Connect to your headphones.

E557Q / E507Q / E437Q / E327

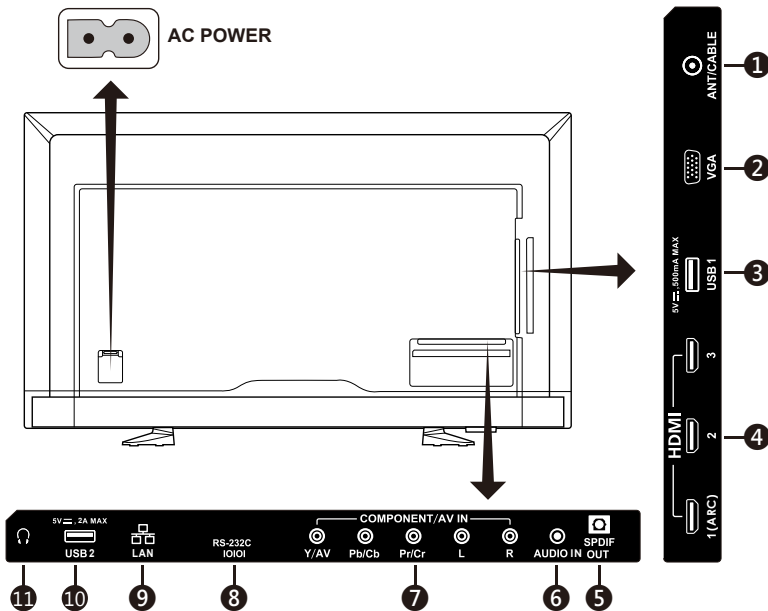

1. **ANT / CABLE** – Connect to an RF antenna or Analog Cable system.
2. **VGA** – Connect to your PC video.
3. **USB 1 port** – Used for accessing photo, music, and movie files.
Please make sure the connector shape and orientation is correctly aligned when connecting the USB device or cable.
4. **HDMI (HDMI-1, HDMI-2, HDMI-3)** – Connect to your HDMI devices.
HDMI-1 terminal can support ARC (Audio Return Channel) function.
ARC output does not work sound effect (Sound mode, Balance, Bass, Treble on OSD).
5. **SPDIF OUT**- Use a digital audio cable to connect to stereo home theater system. SPDIF output does not work sound effect (Sound mode, Balance, Bass, Treble on OSD). SPDIF output does not work Auto function of Internal Speakers on OSD.

6. **AUDIO IN** – Connect to your PC audio.
7. **COMPONENT / AV IN** –
 - Component: Connect to digital video equipment to the Video Green (Y), Blue (Pb), Red (Pr) jacks, and matching Audio White (L) and Red (R) jacks.
 - Composite: Connect to digital video equipment to the Video Green (AV), jacks, and matching Audio White (L) and Red (R) jacks.
8. **RS-232C** – Connect to your PC, and receive the control commands from the PC.
9. **LAN port (RJ-45)**– LAN connection.
10. **USB 2 port** – Power supply port 5V/2A (maximum)
Please make sure the connector shape and orientation is correctly aligned when connecting the USB device or cable. When you use the USB (2A) port for power supply, please use a USB cable that supports 2A.
Do not bind the USB cable. It may cause heat or fire.
11. **Headphone** – Connect to your headphones.

Once your AV device is connected, press the **Source** button on the remote control to select the relevant source to view. (ex: Press **COMP** button to select “Component” if you have connected a source to the Component input.)



Using The Remote Control

(Power)

Press to turn On/Off (standby) the power. (NOTE: To completely turn off the power, unplug the power cord from the power outlet.)

TV

Press to choose ATSC/NTSC tuner source mode.

AV

Press to choose Composite source mode.

COMP

Press to choose Component source mode.

HDMI/PC

Press repeatedly to choose PC IN or HDMI source mode.

0 ~ 9 / —

Press to select channel (Press "—" to choose the sub-channel).

PRE CH

Press to display the previous channel.

Source

Press repeatedly to choose the various input sources.

Mute

Switch the sound On / Off.

VOL + / VOL —

Press + or — to adjust the volume.

CH + / CH —

Press + or — to browse through the channels.

Exit

Press to exit the OSD menu.

Display

Press to show the information about the input source and tuner channel.

FAV

Press to display the Favorite List.



Menu

Press to open the OSD menu.

Navigation Keys (▲, ▼, ◀, ▶, OK)

Press to select or confirm the various function items on the menu.

Navigation Keys (◀◀, ■, ▶▶, II, ▶▶)

Use in the USB menu and HDMI CEC function.

MTS

Press to activate the NTSC tuner sounds such as Stereo, SAP, Mono-tone, and languages of the digital tuner.

Wide

Press to choose the display aspect ratio: Normal / Zoom / Wide / Cinema / Auto (Ratio availability varies by video inputs.)

Picture

Press to choose the picture mode: Dynamic / Standard / Energy Savings / Theater / Game / Custom.

Audio

Press to choose sound mode: Standard / Movie / Music / News / Custom.

CH-List

Press to display the Channel List.

C C

Press to activate the Closed Caption.

Operating Range for the Remote Control

Point the top of the remote control toward the LCD TV's remote sensor during button operation.

Use the remote control within a distance of about 7 m (23 ft.) from remote control sensor or at a horizontal and vertical angle of within 30° within a distance of about 3.5 m (10 ft.).

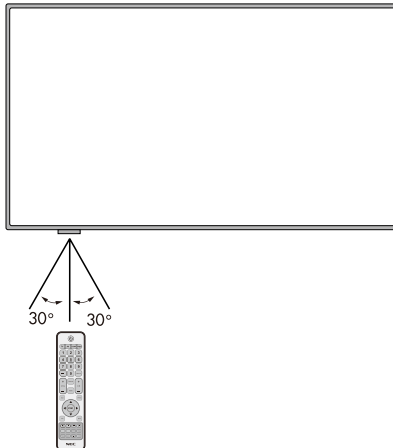
**CAUTION:**

Important, the remote control system may not function when direct sunlight or strong illumination strikes the remote control sensor or when there is an object in the path.

Timing Table

Resolution	Refresh rate (Hz)	Component	HDMI Video				
			E327	E437Q	E507Q	E557Q	E657Q
640 x 480p	60	-			•		
720 x 480i	60	•			•		
720 x 480p	60	•			•		
720 x 576i	50	•			•		
720 x 576p	50	•			•		
1280 x 720p	50	•			•		
1280 x 720p	60	•			•		
1920 x 1080i	50	•			•		
	60				•		
1920 x 1080p	24	•			•		
	25				•		
	30				•		
	50				•		
	60				•		
3840 x 2160p	24	-	-	•	•	•	•
	25	-	-	•	•	•	•
	30	-	-	•	•	•	•
	50	-	-	•	•	•	•
	60	-	-	•	•	•	•
4096 x 2160p	24	-	-	•	•	•	•
	25	-	-	•	•	•	•
	30	-	-	•	•	•	•
	50	-	-	•	•	•	•
	60	-	-	•	•	•	•

Resolution	Refresh rate (Hz)	VGA					HDMI PC				
		E327	E437Q	E507Q	E557Q	E657Q	E327	E437Q	E507Q	E557Q	E657Q
720 x 400	70			•					•		
640 x 480	60			•					•		
800 x 600	56			•					•		
	60			•					•		
1024 x 768	60			•					•		
1280 x 720	60			•					•		
1280 x 800	60			•					•		
1280 x 960	60			•					•		
1280 x 1024	60			•					•		
	75			•					•		
1400 x 1050	60 (RB)			•					•		
1440 x 900	60			•					•		
1600 x 1200	60			•					•		
1680 x 1050	60			•					•		
1920 x 1080	60			•					•		
848 x 480	60	•	-	-	-	-	•	-	-	-	-
2048 x 1152	60	-	•	•	•	•	-	•	•	•	•
	30	-	-	-	-	-	-	•	•	•	•
3840 x 2160	60	-	-	-	-	-	-	•	•	•	•
	60	-	-	-	-	-	-	•	•	•	•
1280 x 768	60	-	-	-	-	•	-	-	-	-	
1360 x 768	60	-	-	-	-	•	-	-	-	-	
1366 x 768	60	-	-	-	-	•	•	•	•	•	
1920 x 1200	60	-	-	-	-	-	•	•	•	•	
1920 x 1440	60	-	-	-	-	-	•	•	•	•	
2560 x 1600	60	-	-	-	-	-	-	•	•	•	•

Navigating The On-Screen Menu

Press the **Menu** button to display and **Exit** button to close the main menu. Use the Navigation Keys to navigate, select, adjust or confirm an item on the OSD (On-Screen Display) menu.

NOTE: Some features may only be available in a particular conditions.

Video Menu

Video Menu adjusts video items.

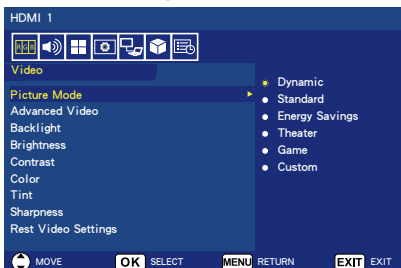

1. Picture Mode

Enter this menu to select from preset picture settings to optimize your TV's performance.

Dynamic / Standard / Energy Savings / Theater / Game / Custom.

HDR Dynamic / HDR Video
(depends on input content format). *(Except for E327)*

2. Advanced Video

Select advanced video settings.

[Aspect Ratio]

Adjust how the picture fills the screen.

Normal / Zoom / Wide / Cinema / Auto

[Backlight Dimming]

Optimize the backlight brightness to enhance contrast and reduce total power consumption.

Off / Low / High

[Color Temperature]

Select white tone of the picture.

Cool / Normal / Warm / Native.

[Noise Reduction]

Set to reduce the video noise.

Off / Low / Mid / High

[Adaptive Contrast]

Enhance the contrasts between darkness and brightness to optimization the picture.

Off / On

[Gamma]

Adjust the middle-range luminance of the picture.

Low / Mid / High

[Room Light Sensing]

When enabled, the ambient light will be taking into consideration to determine the final picture viewing quality.

On / Off

[MEMC]

Select smooth levels of fast motion scenes.

Off / Smooth / Ultra Smooth / 24p Film Mode

(Only for E557Q / E657Q)

[Color Enhance]

Change the Color and saturation of the picture to make the image more colorful and lively.

Off / Vivid / Wide

[HDR Mode]

Select the different luminance experience of HDR contents.

Auto / Low / Mid / High

(Except for E327)

3. Backlight

Set the backlight brightness from 0 – 100.

If Room Light Sensing is enable, Backlight setting is disable.

4. Brightness

Adjust picture brightness from 0 – 100.

5. **Contrast**
Adjust picture contrast from 0 – 100.
6. **Color**
Adjust picture color from 0 – 100.
7. **Tint**
Adjust the color tone (Red, Green, Blue) of the picture from R50 – G50.
8. **Sharpness**
Adjust object edges to optimize picture detail from 0 – 100.
9. **Reset Video Settings**
Reset video settings to factory default settings.

Audio Menu

Audio Menu provides an audio adjustment for user to modify the audio setting.

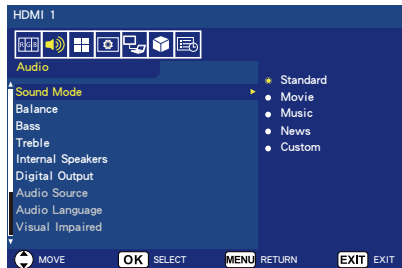

1. **Sound Mode**
Select preset audio modes.
Standard / Movie / Music / News / Custom.
2. **Balance**
Adjust the audio balance for the TV's internal left and right speakers from L50 – R50.
3. **Bass**
Enhance the low frequencies.
0 – 100
4. **Treble**
Enhance the high frequencies.
0 – 100

5. **Internal Speakers**
Select **Off** to turn off the internal speakers.

Select **On** to turn on the internal speakers.

By selecting **Auto**, the sound will be output to headphone if it is connected. Otherwise, the speaker will output the sound.
6. **Digital Output**
Select optical output options: **RAW** or **PCM** (*Only available for digital channels or HDMI input source*)
7. **Audio Source**
Select audio sources in analog channels.
8. **Audio Language**
Select language options in digital channels. (*Only available for digital TV programs*)
9. **Visual Impaired**
Select to turn On/Off support methods for visual impaired. (*Only available for digital channels*)
10. **Menu Speech**
Enable speech function for OSD menu and certain operations.
11. **PC Audio Input**
Allowing user to choose the audio source from PC audio jack when a PC/DVI timing is input to HDMI ports.
Off / On
12. **Reset Audio Settings**
Reset Audio settings to factory default settings.

Channels Menu

Channel Menu allows you to set your signal source options. According to various requirements in different source modes, certain features could be hidden (disabled) on the menu.

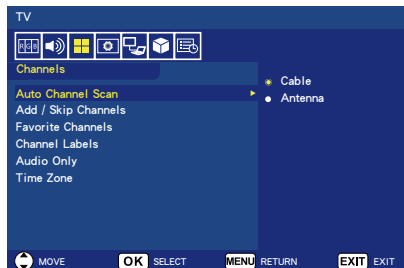

1. **Auto Channel Scan**
Automatically search the available channels.
2. **Add/Skip Channels**
Manually add or skip channels to the channel list.
3. **Favorite Channels**
Add channels to your favorite channel list.
4. **Channel Labels**
Create labels to any channel.
5. **Audio Only**
When activated, the TV screen will be turned off right away whereas the audio keeps playing. This is particular useful for power saving while viewing the audio broadcast programs on the TV.
Any press of the button except the **⏻ (Power)** button on the remote control will turn on the screen.
6. **Time Zone**
Select the time zone area where your TV is installed. For NAFTA TV models only.

Setup Menu

Setup Menu in TV mode is shown below. According to various requirements in different source modes, certain features could be hidden (disabled) on the menu.

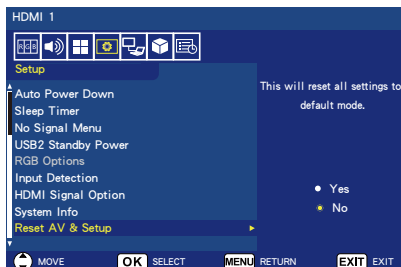
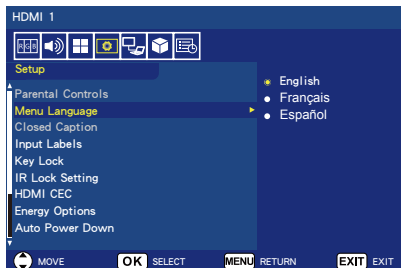

1. **Parental Controls**
Set TV parental controls. This function blocks out the picture and sound of the selected rating levels.

The factory preset password to enter **Parental Controls** feature is a 4-digit number **0000**.
[Block Unrated TV]
Block or unblock the unrated programs.
[US]
Set the parental control level using **Movie** memu or **US TV ratings lock** memu.
[Canadian]
Set the parental control level using **Canadian English** memu or **Canadian French** memu.

[Change Password]

Change the 4-digit password. You will have to enter the new password first, then enter again the new password to confirm. Make sure to keep your new password.

[RRT5]

Use Region 5 to block various types of movies and television programs based on ratings systems used in the USA that you feel may be inappropriate due to its content.

The Region 5 option will operate for Digital Channels (ATSC) only.

[Reset RRT5]

Clear the downloaded RRT5 rating information and restore to the factory default settings.

2. Menu Language

Select the menu display language.

English / Français / Español

3. Closed Caption

Adjust the Closed Caption settings.

Caption Display / Analog Captions / Digital Captions / Digital CC Settings

4. Input Labels

Create labels for the devices connected to your TV.

5. Key Lock

Lock or unlock the power button on the TV's panel.

6. IR Lock Setting

Select **On** to lock your remote control, and the remote control will disable to control the TV. Press **Display** button for 5 seconds to unlock it.

7. HDMI CEC

This function enables you to control the HDMI CEC compliant device connected via the HDMI connector.

[Enable CEC]

Select **On** to enable HDMI CEC.

[Audio Receiver]

Select **On** to enable ARC (Audio Return Channel) function.

ARC is an audio link which can replace other cables between the Monitor and the receiver or speaker system. HDMI-1 terminal can support ARC function.

[Device List]

Show the device list.

8. Energy Options

Home mode is intended for home use, and will save much energy. In this mode, the Monitor automatically switches to Auto Power save mode and then Auto Standby mode when no external signal is input.

Retail mode is a relatively more energy consuming mode. In this mode, the Monitor does not switch to Auto Power save mode or Auto Standby mode when no external signal is input.

Office mode is between Home mode and Retail mode. In this mode, the Monitor automatically switches to Auto Power save mode but will not continue to switch to Auto Standby mode when no external signal is input.

9. Auto Power Down

Select **On** to enable your TV to turn off automatically when you do not press any buttons in 4 hours.

10. Sleep Timer

Select how long the TV will take to automatically turn itself off.
Off / 5 / 10 / 15 / 30 / 60 / 90 / 120 / 180 / 240 (minutes)

11. **No Signal Menu**
Select how long the No Signal message will display. **Off / 10 seconds / 30 seconds / 1 minutes / 5 minutes / 10 minutes / 15 minutes**
12. **USB2 Stanby Power**
Select **On** to keep supply power to USB 2 port during Auto Power save or Auto Standby mode.
13. **RGB Options**
(Only available for VGA input, and when there is VGA signal input)
[Auto Adjust]
Automatically adjust the image settings such as position.
[H. Position]
Adjust horizontal position.
[V. Position]
Adjust vertical position.
[Clock]
Set to the minimum level if noise occurs.
[Phase]
Eliminate flicker and distortion.
[Reset RGB Options]
Reset RGB options to factory default settings.
14. **Input Detection**
Triggered by the signal loss of current input source, the system will switch among the input sources in order (First) or by priorities pre-defined by user (Custom).
None / First / Custom
None : The Monitor will not search for signals at the other video input ports.

First : When the current video input signal is not present, the monitor searches for a video signal from another video input port.

If a video signal is present in the other input, the monitor switches from the current video source to this active video source automatically.

The monitor will not look for any other video signals while the current video source is present.

Custom : Sets the priority of input signals. When CUSTOM is selected, the monitor searches on preset inputs only.

15. **HDMI Signal Option**
Select EDID option according your own source devices.
If screen popup no audio message or no image display, please change this option to standard.
Standard Display regular quality HDMI format such as 4K 30Hz or FHD HDMI contents from source devices with HDCP 1.4.
Professional Display high quality HDMI format such as 4K 60Hz and HDR contents from source devices with HDCP 2.2.
16. **System Info**
Indicate the display information.
17. **Reset AV & Setup**
Reset all **Audio, Video,** and **Setup** settings to factory default settings.

Control Settings Menu

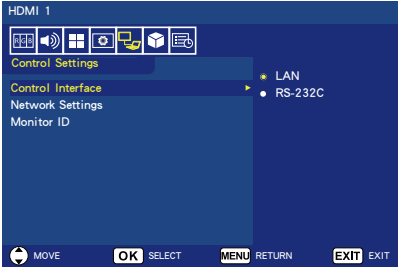

1. Control Interface

Set the communication channel supported by the application software accordingly.

LAN : Network function is enable. RS-232C function is disable.

RS-232C : RS-232C function is enable. Network function is disable.

2. Network Settings

Allow user to configure the network-related parameters.

DHCP Manual DNS : You can input DNS Primary and DNS Secondary.

DHCP ON : Enabling this option automatically assigns an IP address to the monitor from your DHCP server.

DHCP OFF : Disabling this option allows you to enter a fixed IP address and subnet mask data obtained from your network administrator.

[IP ADDRESS] Set your IP address for the monitor connected to the network

[SUBNET MASK] Set your subnet mask data for the monitor connected to the network

[DEFAULT GATEWAY] Set your default gateway for the monitor connected to the network

[DNS PRIMARY] Enter the primary DNS server settings

of the network connected with the monitor.

[DNS SECONDARY] Enter the secondary DNS server settings of the network connected with the monitor.

[MAC ADDRESS] Displays the MAC ADDRESS. You cannot change.

[SAVE] You can save those setting.

3. Monitor ID

Set the monitor ID number from **1–100**.

USB Menu

You could browse image, music, or video files from USB storage device.

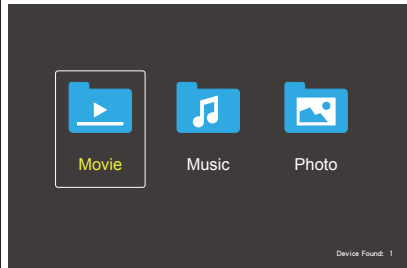

- Press **Exit** button to exit the USB mode or press **Source** button to select other source to exit.

To control while in folder:







- Press **▲**, **▼**, **◀**, **▶** button to browse the files.
- Press **OK** button to open a folder and press **▶/||** button to play the selected file.
- Press **EXIT** button to return to Media Type Select page.

To control the operation bar:

- Press **Menu** button to display operation bar on the bottom of screen.
- Press **Display** button to show the information window.

- Press ◀, ▶ button to select the item on operation bar.
- Press **EXIT** to hide operation bar.

To control while viewing photos:

- Select  or press ▶/|| button to play image slideshow.
- Select  or press ▶/|| button to pause the playing image.
- Select  or press ◀◀ button to go to previous image.
- Select  or press ▶▶ button to go to next image.
- Select  or press ■ button to stop the playing image slideshow.
- Select  to repeat images in the folder with **Repeat None / Repeat One / Repeat All / Repeat Random** options.

Repeat None

After starting playing the files selected in the menu, each file in the same folder is played once in order until the last one.

Also, if you start playing several files checked in the menu, they are played once.

Repeat One

The one file selected or checked in the menu is repeatedly played.





Repeat All



All the files in the same folder are repeatedly played.

Also, if several files are checked in the menu and played, they are repeatedly played.

Repeat Random









Select to play images in the folder randomly.

- Select  to view playlist of images or select a image from the list to play.
- Select  or press **Display** button to show the playing image's information.
- Select  or  to rotate the image clockwise or anti-clockwise.

- Select  or  to switch image size between 4 styles.
X1 / X2 / X4 / X8 and **X1/8 / X1/4 / X1/2 / X1**

- Select  to scroll the image by remote control. (Only apply to **Zoom 2, Zoom 4** and **Zoom 8** styles.)

To control while enjoying musics or videos:

- Select  or press ▶/|| button to play the file.
- Select  or press ▶/|| button to pause the playing file.
- Select  to play fast backward.
FB2X / FB4X / FB8X / FB16X / FB32 (Only for video)
- Select  button to play fast forward.
FF2X / FF4X / FF8X / FF16X / FF32 (Only for video)
- Select  or press ◀◀ button to go to previous file. When playing video, press once to play from the beginning; press twice to go to previous file.
- Select  or press ▶▶ button to go to next file.
- Select  or press ■ button to stop the playing file.
- Select  to repeat files in the folder with **Repeat None / Repeat One / Repeat All** options.

Repeat None

After starting playing the files selected in the menu, each file in the same folder is played once in order until the last one.

Also, if you start playing several files checked in the menu, they are played once.

Repeat One

The one file selected or checked in the menu is repeatedly played.

Repeat All

All the files in the same folder are repeatedly played.

Also, if several files are checked in the menu and played, they are repeatedly played.



Repeat Random

Select  to play music or video in the folder randomly.

AB-Repeat

Select  to loop through a certain part of video.

(Only for video)

- Select  to view playlist or select a file from the list to play.
- Select  or press **Display** button to show the playing file's information.
- Select  or press **Wide** button to choose the display aspect ratio while playing the video file.

4:3 / 16:9 / Auto

(Only for video)

**CAUTION:**

- There is no guarantee other than USB Mass storage class devices.
- A JPEG image modified with PC may not be displayed.
- Partly degraded files might be displayed at a reduced resolution.
- Not guaranteed to support all USB devices.
- Do not use a USB Hub.
- Do not support multi-partition USB.

NOTE:

- Support USB 2.0 Type A connector (DC5V, max. 500mA). For USB device over 500mA, we suggest to use adaptor or external power.
- We recommend using a USB device formatted to NTFS (New Technology File System) with this TV.

- When connecting a USB device used with this TV and formatted to FAT16 or FAT32 to a computer, a message prompting you to scan the USB device may appear. In this case, scan the USB device.

Data Format for USB

Supported file system	FAT16/32, NTFS
Max. folder layer	9
PHOTO mode	
Data format	JPEG, JPG, JPE
Max. number of photos	997
Min. image resolution	75 × 75 pixels
Max. image resolution (Progressive DCT)	1,024 × 768 pixels
Max. image resolution (Baseline Sequential DCT)	15,360 × 8,640 pixels
MUSIC mode	
Data format	MP3
Bit rate	32Kbps ~ 320Kbps
MOVIE mode	
Container format	MPG, MPEG, MPEG2-TS, MPEG2-PS, MP4, MKV, AVI, Motion JPEG
Video codec	MPEG1, MPEG2, H.263, H.264, H.265, WMV
Audio codec	LPCM, MP3, AC-3, AAC, WMA standard, WMA 9 Professional



CAUTION:

- Sometimes, it may not be possible to play a video file even when the conditions above are met. The file may not be played properly depending on the bit rate. Video files made with a codec not supported by the TV cannot be played.

NOTE:

- Only single-byte alphanumeric characters can be used in the folder name and the file name. Double-byte characters cannot be used.
- The character code used for the folder name and the file name may differ depending on the digital device used.

USB Demo Mode

The Monitor could automatically play image, music, or video files from USB storage device with USB Demo Mode.

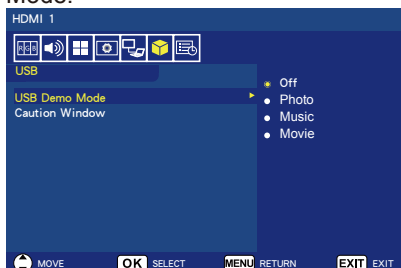

Enable USB Demo Mode

RETAIL mode is set under Energy Options in the on-screen display menu.

USB Demo Mode becomes Enable at RETAIL mode.

- Press **MENU** button to open OSD menu.
- Go to USB page and select USB Demo Mode.
- Select which file type will be played with USB Demo Mode.

Start USB Demo Mode

Demo mode will start automatically when:

- USB Demo Mode is turned on.
- A demo folder named with "NDS_DEMO" is stored on USB storage device.
- The input sources is not set to USB.
- No OSD display on screen except for No signal / No channel found.
- No user action more than 8 seconds.

Play files in USB Demo Mode

During demo mode:

- The **Power**, **Volume** and **Mute** buttons on remote control are functional. But all other buttons will interrupt demo play and then return to previous source.
- Removing USB storage device also stops demo play.
- If the Monitor is turned off during demo mode, it will continue demo play when the Monitor is turned on next time (if USB storage device is still plugged).

Scheduling Menu

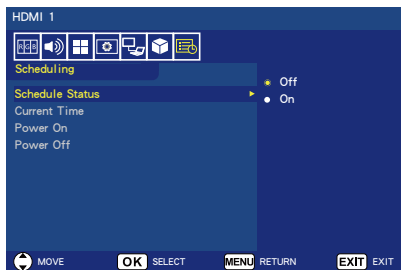

1. **Schedule Status**
This function enables your TV to turn on and off automatically.
Select **On** to enable Time Schedule.
2. **Current Time**
Set the current time before using this function.
3. **Power On**
Set the time for your TV to turn on.
4. **Power Off**
Set the time for your TV to turn off.

NOTE:

- Only single-byte alphanumeric characters can be used in the folder name and the file name. Double-byte characters cannot be used.
- The character code used for the folder name and the file name may differ depending on the digital device used.

Maintenance and Recycling

Care Of The Screen

Do not rub or strike the screen with anything hard as this may scratch, mar, or even damage the screen permanently. Unplug the power cord before cleaning the screen. Dust the TV by wiping the screen and the cabinet with a soft, clean cloth. If the screen requires additional cleaning, use a clean, damp cloth. Do not use liquid cleaners, aerosol cleaners, or solvents of any kind.

Mobile Telephone Warning

Keep your mobile telephone away from your TV to avoid disturbances in the picture or sound, possibly causing permanent damage to your TV.

End Of Life Directives

In an effort to produce environmentally friendly products, your new TV contains materials that can be recycled and reused. At the end of your TV's life, specialized companies can minimize display waste by separating the reusable materials from non-reusable materials. Please ensure you dispose of your TV according to local regulations.

Manufacturer's Recycling and Energy Information

NEC DISPLAY SOLUTIONS is strongly committed to environmental protection and sees recycling as one of the company's top priorities in trying to minimize the burden placed on the environment. We are engaged in developing environmentally-friendly products, and always strive to help define and comply with the latest independent standards from agencies such as ISO (International Organisation for Standardization) and TCO (Swedish Trades Union).

Disposing of your old NEC product

The aim of recycling is to gain an environmental benefit by means of re-use, upgrading, reconditioning or reclamation of material. Dedicated recycling sites ensure that environmentally harmful components are properly handled and securely disposed. To ensure the best recycling of our products, **NEC DISPLAY SOLUTIONS offers a variety of recycling procedures** and gives advice on how to handle the product in an environmentally sensitive way, once it has reached the end of its life.

All required information concerning the disposal of the product and country-specific information on recycling facilities can be found on our following websites:

<http://www.nec-display-solutions.com/greencompany/> (in Europe),

<http://www.nec-display.com> (in Japan) or

<http://www.necdisplay.com> (in USA).

Energy Saving

This monitor features an advanced energy saving capability. When a Display Power Management signal is sent to the monitor, the Energy Saving mode is activated. This display enters into two types of Energy Saving mode during Energy options function sets Home mode. When select LAN mode (refer to page 54), this display will automatically enter into Auto Power save mode (networked Standby mode); and if select RS-232C mode (refer to page 52), this display will automatically enter into Auto Standby mode (general Standby mode).

For additional information visit:

<http://www.necdisplay.com/> (in USA)

<http://www.nec-display-solutions.com/> (in Europe)

<http://www.nec-display.com/global/index.html>
(Global)



Mode	Power consumption	LED color
ON Mode (with USB, with Audio)	Approx. 170 W (E657Q) Approx. 160 W (E557Q) Approx. 145 W (E507Q) Approx. 130 W (E437Q) Approx. 70 W (E327)	None
Energy Saving mode (Auto Power save)	Less than 2.0 W	Blinking Red
Energy Saving mode (Auto Standby)	Less than 0.5 W	Red

Product Specification

This model complies with the specifications listed below.
 Designs and specifications are subject to change without notice.
 This model may not be compatible with features and/or specifications that may be added in the future.

E657Q

LCD Module:		65"/ 1639.0 mm diagonal
	Resolution:	3,840 x 2,160
	Color:	Over 1.07 billion colors (depending on video card used)
	Brightness:	350cd/m2 (Typ.) @ 25°C
Frequency	Horizontal:	31 – 83KHz (Analog input) 15.625/15.734KHz, 31 – 136KHz (Digital input)
	Vertical:	60Hz – 75Hz (Analog input) 24Hz, 30Hz, 50Hz, 60Hz, 70Hz (Digital input)
Pixel Clock		Analog: 13.5 MHz, 25.0 MHz – 165.0 MHz Digital: 25.0 MHz – 600.0 MHz
Viewable Size		1428.48 (H) x 803.52 (V) mm
Television System		NTSC Standard, ATSC Standard (8-VSB, Clear-QAM)
Channel Coverage		VHF: 2 through 13 UHF: 14 through 69 Cable TV: Mild band (A - 8 through A - 1, A through I), Super band (J through W), Hyper band (AA through ZZ, AAA, BBB), Ultra band (65 through 94, 100 through 125)
Input Signal		
COMPONENT	Component	RCA Y: 1.0 V p-p / 75 ohm, Pb/Pr (Cb/Cr): 0.7 V p-p / 75 ohm
AV IN	Composite	RCA 1.0 V p-p / 75 ohm
VGA	Analog RGB	Mini D-sub 15 pin 0.7Vp-p / 75 ohm
HDMI	Digital YUV Digital RGB	Type A Connectors HDMI (HDCP 1.4 / 2.2)
AUDIO		
AUDIO IN	Analog Audio Input	Stereo mini jack Stereo L/R 0.5 Vrms
AUDIO L / R	Analog Audio Input	RCA 0.5 Vrms / 75 ohm
HDMI	Digital Audio Input	Type A Connectors PCM 32, 44.1, 48KHz (16 / 20 / 24bit)
SPDIF OUT	Digital Audio Output	PCM 32, 44.1, 48KHz (16 / 20 / 24bit), Fibre optic
Headphone	Analog Audio Output	Stereo mini jack Stereo L/R 0.5 Vrms

Speaker Output	Internal Speaker	10 W + 10 W (6 ohm)
Control	RS-232C IN: LAN	9 Pin D-sub RJ-45 10 BASE-T/100 BASE-TX
USB 1 USB 2	USB 2.0 USB 2.0	Type A Connectors, DC 5V / 500mA Type A Connectors, DC 5V / 2A
Power Supply	Auto Power save mode: Auto Standby mode: Power consumption:	1.7 A @ 120 V AC, 60Hz < 2.00 W < 0.50 W 170 W
Operational Environment	Temperature: Humidity: Altitude:	0°C – 40°C / 32°F – 104°F 10% – 80% 0 – 5,000 m
Storage Environment	Temperature: Humidity: Absolute Air Humidity: Max. Change of Temp.: Air Pressure: Radiation Solar Heat:	-10°C – 60°C / 14°F – 140°F 5% – 85% 1-25 g/m ³ 0.5°C/min (max. 10°C / 30min) 795 – 1,060 mbar (79.5–106Kpa) 700 W/m ²
Dimension	with Stand and Base:	1462.2 (W) x 881.3 (H) x 350 (D) mm, 57.6 (W) x 34.7 (H) x 13.8 (D) inch
	without Stand and Base:	1462.2 (W) x 842.3 (H) x 96.7 (D) mm 57.6 (W) x 33.2 (H) x 3.8 (D) inch
Weight	with Stand and Base:	24.6 kg (54.3 lbs)
	without Stand and Base:	23.8 kg (52.5 lbs)
VESA compatible mounting interface		400 mm x 200 mm (M6, VESA hole depth 17 mm)
Plug & Play		VESA DDC2B
Accessories		Remote control (1), 1.5 V AAA batteries (2) Power cord (1) (3.0 m), HDMI cable (1) (2.0m), Setup Manual (1)

NOTE:

- All specifications, weights, and dimensions are subject to change without prior notice. Please access www.necdisplay.com for detailed specifications and dimensions for custom installations.
- This model may not be compatible with features and/or specifications that may be added in the future.

E557Q

LCD Module:		55"/ 1387.8 mm diagonal
	Resolution:	3,840 x 2,160
	Color:	Over 1.07 billion colors (depending on video card used)
	Brightness:	350cd/m2 (Typ.) @ 25°C
Frequency	Horizontal:	31 – 83KHz (Analog input) 15.625/15.734KHz, 31 – 136KHz (Digital input)
	Vertical:	60Hz – 75Hz (Analog input) 24Hz, 30Hz, 50Hz, 60Hz, 70Hz (Digital input)
Pixel Clock		Analog: 13.5 MHz, 25.0 MHz – 165.0 MHz Digital: 25.0 MHz – 600.0 MHz
Viewable Size		1209.6 (H) × 680.4(V) mm
Television System		NTSC Standard, ATSC Standard (8-VSB, Clear-QAM)
Channel Coverage		VHF: 2 through 13 UHF: 14 through 69 Cable TV: Mild band (A - 8 through A - 1, A through I), Super band (J through W), Hyper band (AA through ZZ, AAA, BBB), Ultra band (65 through 94, 100 through 125)
Input Signal		
COMPONENT	Component	RCA Y: 1.0 V p-p / 75 ohm, Pb/Pr (Cb/Cr): 0.7 V p-p / 75 ohm
AV IN	Composite	RCA 1.0 V p-p / 75 ohm
VGA	Analog RGB	Mini D-sub 15 pin 0.7Vp-p / 75 ohm
HDMI	Digital YUV Digital RGB	Type A Connectors HDMI (HDCP 1.4 / 2.2)
AUDIO		
AUDIO IN	Analog Audio Input	Stereo mini jack Stereo L/R 0.5 Vrms
AUDIO L / R	Analog Audio Input	RCA 0.5 Vrms / 75 ohm
HDMI	Digital Audio Input	Type A Connectors PCM 32, 44.1, 48KHz (16 / 20 / 24bit)
SPDIF OUT	Digital Audio Output	PCM 32, 44.1, 48KHz (16 / 20 / 24bit), Fibre optic
Headphone	Analog Audio Output	Stereo mini jack Stereo L/R 0.5 Vrms
Speaker Output	Internal Speaker	10 W + 10 W (6 ohm)
Control	RS-232C IN: LAN	9 Pin D-sub RJ-45 10 BASE-T/100 BASE-TX

USB 1 USB 2	USB 2.0 USB 2.0	Type A Connectors, DC 5V / 500mA Type A Connectors, DC 5V / 2A
Power Supply	Auto Power save mode: Auto Standby mode: Power consumption:	1.6 A @ 120 V AC, 60Hz < 2.00 W < 0.50 W 160 W
Operational Environment	Temperature: Humidity: Altitude:	0°C – 40°C / 32°F – 104°F 10% – 80% 0 – 5,000 m
Storage Environment	Temperature: Humidity: Absolute Air Humidity: Max. Change of Temp.: Air Pressure: Radiation Solar Heat:	-10°C – 60°C / 14°F – 140°F 5% – 85% 1-25 g/m ³ 0.5°C/min (max. 10°C / 30min) 795 – 1,060 mbar (79.5–106Kpa) 700 W/m ²
Dimension	with Stand and Base:	1239.2 (W) x 749.6 (H) x 255 (D) mm, 48.8 (W) x 29.5 (H) x 10.0 (D) inch
	without Stand and Base:	1239.2 (W) x 711.6 (H) x 79.2 (D) mm, 48.8 (W) x 28.0 (H) x 3.1 (D) inch
Weight	with Stand and Base:	15.5 kg (34.2 lbs)
	without Stand and Base:	15.0 kg (33.1 lbs)
VESA compatible mounting interface		400 mm x 200 mm (M6, VESA hole depth 17 mm)
Plug & Play		VESA DDC2B
Accessories		Remote control (1), 1.5 V AAA batteries (2) Power cord (1) (3.0 m), HDMI cable (1) (2.0m), Setup Manual (1)

NOTE:

- All specifications, weights, and dimensions are subject to change without prior notice. Please access www.necdisplay.com for detailed specifications and dimensions for custom installations.
- This model may not be compatible with features and/or specifications that may be added in the future.

E507Q

LCD Module:		50"/ 1257.3 mm diagonal
	Resolution:	3,840 x 2,160
	Color:	Over 1.07 billion colors (depending on video card used)
	Brightness:	350cd/m2 (Typ.) @ 25°C
Frequency	Horizontal:	31 – 83KHz (Analog input) 15.625/15.734KHz, 31 – 136KHz (Digital input)
	Vertical:	60Hz – 75Hz (Analog input) 24Hz, 30Hz, 50Hz, 60Hz, 70Hz (Digital input)
Pixel Clock		Analog: 13.5 MHz, 25.0 MHz – 165.0 MHz Digital: 25.0 MHz – 600.0 MHz
Viewable Size		1095.8 (H) × 616.4(V) mm
Television System		NTSC Standard, ATSC Standard (8-VSB, Clear-QAM)
Channel Coverage		VHF: 2 through 13 UHF: 14 through 69 Cable TV: Mild band (A - 8 through A - 1, A through I), Super band (J through W), Hyper band (AA through ZZ, AAA, BBB), Ultra band (65 through 94, 100 through 125)
Input Signal		
COMPONENT	Component	RCA Y: 1.0 V p-p / 75 ohm, Pb/Pr (Cb/Cr): 0.7 V p-p / 75 ohm
AV IN	Composite	RCA 1.0 V p-p / 75 ohm
VGA	Analog RGB	Mini D-sub 15 pin 0.7Vp-p / 75 ohm
HDMI	Digital YUV Digital RGB	Type A Connectors HDMI (HDCP 1.4 / 2.2)
AUDIO		
AUDIO IN	Analog Audio Input	Stereo mini jack Stereo L/R 0.5 Vrms
AUDIO L / R	Analog Audio Input	RCA 0.5 Vrms / 75 ohm
HDMI	Digital Audio Input	Type A Connectors PCM 32, 44.1, 48KHz (16 / 20 / 24bit)
SPDIF OUT	Digital Audio Output	PCM 32, 44.1, 48KHz (16 / 20 / 24bit), Fibre optic
Headphone	Analog Audio Output	Stereo mini jack Stereo L/R 0.5 Vrms
Speaker Output	Internal Speaker	10 W + 10 W (6 ohm)
Control	RS-232C IN: LAN	9 Pin D-sub RJ-45 10 BASE-T/100 BASE-TX

USB 1 USB 2	USB 2.0 USB 2.0	Type A Connectors, DC 5V / 500mA Type A Connectors, DC 5V / 2A
Power Supply	Auto Power save mode: Auto Standby mode: Power consumption:	1.5 A @ 120 V AC, 60Hz < 2.00 W < 0.50 W 145 W
Operational Environment	Temperature: Humidity: Altitude:	0°C – 40°C / 32°F – 104°F 10% – 80% 0 – 5,000 m
Storage Environment	Temperature: Humidity: Absolute Air Humidity: Max. Change of Temp.: Air Pressure: Radiation Solar Heat:	-10°C – 60°C / 14°F – 140°F 5% – 85% 1-25 g/m ³ 0.5°C/min (max. 10°C / 30min) 795 – 1,060 mbar (79.5–106Kpa) 700 W/m ²
Dimension	with Stand and Base:	1123.6 (W) x 683.7 (H) x 255 (D) mm, 44.2 (W) x 26.9 (H) x 10.0 (D) inch
	without Stand and Base:	1123.6 (W) x 646.7 (H) x 77 (D) mm, 44.2 (W) x 25.5 (H) x 3.0 (D) inch
Weight	with Stand and Base:	12.9 kg (28.4 lbs)
	without Stand and Base:	12.4 kg (27.3 lbs)
VESA compatible mounting interface		400 mm x 200 mm (M6, VESA hole depth 17.5 mm)
Plug & Play		VESA DDC2B
Accessories		Remote control (1), 1.5 V AAA batteries (2) Power cord (1) (3.0 m), HDMI cable (1) (2.0m), Setup Manual (1)

NOTE:

- All specifications, weights, and dimensions are subject to change without prior notice. Please access www.necdisplay.com for detailed specifications and dimensions for custom installations.
- This model may not be compatible with features and/or specifications that may be added in the future.

E437Q

LCD Module:		43"/ 1079.9 mm diagonal
	Resolution:	3,840 x 2,160
	Color:	Over 1.07 billion colors (depending on video card used)
	Brightness:	350cd/m2 (Typ.) @ 25°C
Frequency	Horizontal:	31 – 83KHz (Analog input) 15.625/15.734KHz, 31 – 136KHz (Digital input)
	Vertical:	60Hz – 75Hz (Analog input) 24Hz, 30Hz, 50Hz, 60Hz, 70Hz (Digital input)
Pixel Clock		Analog: 13.5 MHz, 25.0 MHz – 165.0 MHz Digital: 25.0 MHz – 600.0 MHz
Viewable Size		941.18 (H) × 529.42 (V) mm
Television System		NTSC Standard, ATSC Standard (8-VSB, Clear-QAM)
Channel Coverage		VHF: 2 through 13 UHF: 14 through 69 Cable TV: Mild band (A - 8 through A - 1, A through I), Super band (J through W), Hyper band (AA through ZZ, AAA, BBB), Ultra band (65 through 94, 100 through 125)
Input Signal		
COMPONENT	Component	RCA Y: 1.0 V p-p / 75 ohm, Pb/Pr (Cb/Cr): 0.7 V p-p / 75 ohm
AV IN	Composite	RCA 1.0 V p-p / 75 ohm
VGA	Analog RGB	Mini D-sub 15 pin 0.7Vp-p / 75 ohm
HDMI	Digital YUV Digital RGB	Type A Connectors HDMI (HDCP 1.4 / 2.2)
AUDIO		
AUDIO IN	Analog Audio Input	Stereo mini jack Stereo L/R 0.5 Vrms
AUDIO L / R	Analog Audio Input	RCA 0.5 Vrms / 75 ohm
HDMI	Digital Audio Input	Type A Connectors PCM 32, 44.1, 48KHz (16 / 20 / 24bit)
SPDIF OUT	Digital Audio Output	PCM 32, 44.1, 48KHz (16 / 20 / 24bit), Fibre optic
Headphone	Analog Audio Output	Stereo mini jack Stereo L/R 0.5 Vrms
Speaker Output	Internal Speaker	10 W + 10 W (6 ohm)
Control	RS-232C IN: LAN	9 Pin D-sub RJ-45 10 BASE-T/100 BASE-TX

USB 1 USB 2	USB 2.0 USB 2.0	Type A Connectors, DC 5V / 500mA Type A Connectors, DC 5V / 2A
Power Supply	Auto Power save mode: Auto Standby mode: Power consumption:	1.3 A @ 120 V AC, 60Hz < 2.00 W < 0.50 W 130 W
Operational Environment	Temperature: Humidity: Altitude:	0°C – 40°C / 32°F – 104°F 10% – 80% 0 – 5,000 m
Storage Environment	Temperature: Humidity: Absolute Air Humidity: Max. Change of Temp.: Air Pressure: Radiation Solar Heat:	-10°C – 60°C / 14°F – 140°F 5% – 85% 1-25 g/m ³ 0.5°C/min (max. 10°C / 30min) 795 – 1,060 mbar (79.5–106Kpa) 700 W/m ²
Dimension	with Stand and Base:	968.1 (W) x 596.3 (H) x 255 (D) mm, 38.1 (W) x 23.5 (H) x 10.0 (D) inch
	without Stand and Base:	968.1 (W) x 559.4 (H) x 76.8 (D) mm, 38.1 (W) x 22.0 (H) x 3.0 (D) inch
Weight	with Stand and Base:	9.4 kg (20.8 lbs)
	without Stand and Base:	8.9 kg (19.7 lbs)
VESA compatible mounting interface		200 mm x 200 mm (M6, VESA hole depth 14.5 mm)
Plug & Play		VESA DDC2B
Accessories		Remote control (1), 1.5 V AAA batteries (2) Power cord (1) (3.0 m), HDMI cable (1) (2.0m), Setup Manual (1)

NOTE:

- All specifications, weights, and dimensions are subject to change without prior notice. Please access www.necdisplay.com for detailed specifications and dimensions for custom installations.
- This model may not be compatible with features and/or specifications that may be added in the future.

E327

LCD Module:		32"/ 801.3 mm diagonal
	Resolution:	1,920 x 1,080
	Color:	Over 16 million colors (depending on video card used)
	Brightness:	350cd/m2 (Typ.) @ 25°C
Frequency	Horizontal:	31 – 83KHz (Analog input) 15.625/15.734KHz, 31 – 83KHz (Digital input)
	Vertical:	60Hz – 70Hz (Analog input) 24Hz, 30Hz, 50Hz, 60Hz, 70Hz (Digital input)
Pixel Clock		25 – 156 MHz
Viewable Size		698.4 (H) × 392.85 (V) mm
Television System		NTSC Standard, ATSC Standard (8-VSB, Clear-QAM)
Channel Coverage		VHF: 2 through 13 UHF: 14 through 69 Cable TV: Mild band (A - 8 through A - 1, A through I), Super band (J through W), Hyper band (AA through ZZ, AAA, BBB), Ultra band (65 through 94, 100 through 125)
Input Signal		
	COMPONENT	Component
		RCA Y: 1.0 V p-p / 75 ohm, Pb/Pr (Cb/Cr): 0.7 V p-p / 75 ohm
	AV IN	Composite
		RCA 1.0 V p-p / 75 ohm
	VGA	Analog RGB
		Mini D-sub 15 pin 0.7Vp-p / 75 ohm
	HDMI	Digital YUV Digital RGB
		Type A Connectors HDMI (HDCP 1.4)
AUDIO		
	AUDIO IN	Analog Audio Input
		Stereo mini jack Stereo L/R 0.5 Vrms
	AUDIO L / R	Analog Audio Input
		RCA 0.5 Vrms / 75 ohm
	HDMI	Digital Audio Input
		Type A Connectors PCM 32, 44.1, 48KHz (16 / 20 / 24bit)
	SPDIF OUT	Digital Audio Output
		PCM 32, 44.1, 48KHz (16 / 20 / 24bit), Fibre optic
Headphone	Analog Audio Output	Stereo mini jack Stereo L/R 0.5 Vrms
Speaker Output	Internal Speaker	5 W + 5 W (6 ohm)
Control	RS-232C IN: LAN	9 Pin D-sub RJ-45 10 BASE-T/100 BASE-TX

USB 1 USB 2	USB 2.0 USB 2.0	Type A Connectors, DC 5V / 500mA Type A Connectors, DC 5V / 2A
Power Supply	Auto Power save mode: Auto Standby mode: Power consumption:	0.7 A @ 120 V AC, 60Hz < 2.00 W < 0.50 W 70 W
Operational Environment	Temperature: Humidity: Altitude:	0°C – 40°C / 32°F – 104°F 10% – 80% 0 – 5,000 m
Storage Environment	Temperature: Humidity: Absolute Air Humidity: Max. Change of Temp.: Air Pressure: Radiation Solar Heat:	-10°C – 60°C / 14°F – 140°F 5% – 85% 1-25 g/m ³ 0.5°C/min (max. 10°C / 30min) 795 – 1,060 mbar (79.5–106Kpa) 700 W/m ²
Dimension	with Stand and Base:	726.7 (W) x 461.1 (H) x 255 (D) mm, 28.6 (W) x 18.2 (H) x 10.0 (D) inch
	without Stand and Base:	726.7 (W) x 424.3 (H) x 79.8 (D) mm, 28.6 (W) x 16.7 (H) x 3.1 (D) inch
Weight	with Stand and Base:	5.8 kg (12.7 lbs)
	without Stand and Base:	5.3 kg (11.6 lbs)
VESA compatible mounting interface		100 mm x 100 mm (M4, VESA hole depth 16 mm)
Plug & Play		VESA DDC2B
Accessories		Remote control (1), 1.5 V AAA batteries (2) Power cord (1) (3.0 m), HDMI cable (1) (2.0m), Setup Manual (1)

NOTE:

- All specifications, weights, and dimensions are subject to change without prior notice. Please access www.necdisplay.com for detailed specifications and dimensions for custom installations.
- This model may not be compatible with features and/or specifications that may be added in the future.

Controlling the LCD TV via RS-232C Remote Control

This LCD TV can be controlled by connecting a personal computer with an RS-232C (reverse type) terminal.

Connection

LCD TV + computer.

- Please turn off the monitor's main power when connecting a computer to the monitor.
- Please turn on the connecting computer first then turn on the monitor's main power.
If you turn on the computer and monitor in reverse order, the com port may not work.

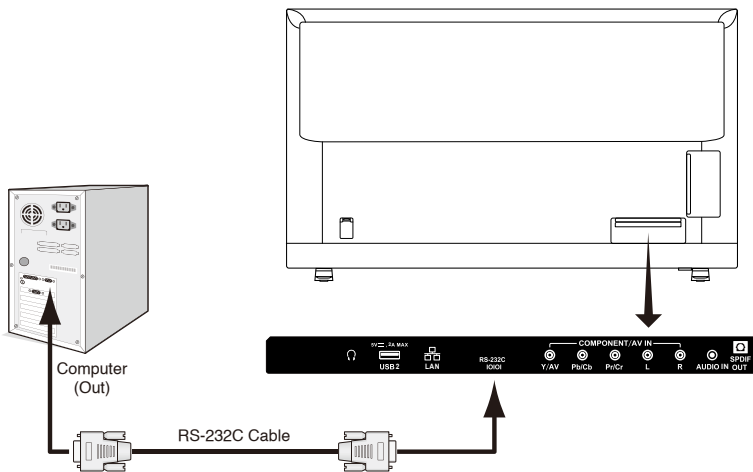

NOTE: If your computer is equipped only with a 25-pin serial port connector, a 25-pin serial port adapter is required.

Contact your supplier for details.

For the pin assignment, please see "2) RS-232C input/output" on page 53.

Communication procedure

Send the control commands from the PC via the RS-232C connector.

The TV operates according to the received command and sends a response message to the PC.

Do not send multiple commands at the same time. Wait until the PC receives the response before sending the next command.

1) Interface

Protocol	RS-232C
Baud rate	9,600 bps
Data length	8 bits

Parity bit	None
Stop bit	1 bit
Communication code	ASCII

This LCD TV uses RXD, TXD and GND lines for RS-232C control. The reverse type cable (null modem cable) (not included) should be used for RS-232C control.

2) PIN ASSIGNMENT

RS-232C input/output

Pin No	RS-232C
1	NC
2	RXD
3	TXD
4	NC
5	GND
6	NC
7	NC
8	NC
9	NC

D-Sub 9-pin (Monitor side)

This LCD monitor uses RXD, TXD and GND lines for RS-232C control.

Control command diagram

Function (Monitor ID = 1)	Code Data
Power ON	01 30 41 30 41 30 43 02 43 32 30 33 44 36 30 30 30 31 03 73 0d
Power OFF	01 30 41 30 41 30 43 02 43 32 30 33 44 36 30 30 30 34 03 76 0d
Input Source Select VGA	01 30 41 30 45 30 41 02 30 30 36 30 30 30 31 03 73 0d
Input Source Select HDMI-1	01 30 41 30 45 30 41 02 30 30 36 30 30 30 31 31 03 72 0d
Input Source Select HDMI-2	01 30 41 30 45 30 41 02 30 30 36 30 30 30 31 32 03 71 0d
Input Source Select HDMI-3	01 30 41 30 45 30 41 02 30 30 36 30 30 30 38 32 03 70 0d
Input Source Select Component	01 30 41 30 45 30 41 02 30 30 36 30 30 30 30 43 03 01 0d
Input Source Select Composite	01 30 41 30 45 30 41 02 30 30 36 30 30 30 30 35 03 77 0d
Input Source USB	01 30 41 30 45 30 41 02 30 30 36 30 30 30 38 37 03 7D 0d
Sound Mute ON	01 30 41 30 45 30 41 02 30 30 38 44 30 30 30 31 03 09 0d
Sound Mute OFF	01 30 41 30 45 30 41 02 30 30 38 44 30 30 30 32 03 0a 0d

Controlling the LCD TV via LAN Control

Connecting to a Network

Using a LAN cable allows you to specify the Network Settings and the Alert Mail Settings by using an HTTP server function.

To use a LAN connection you are required to assign an IP address.

Example of LAN connection:

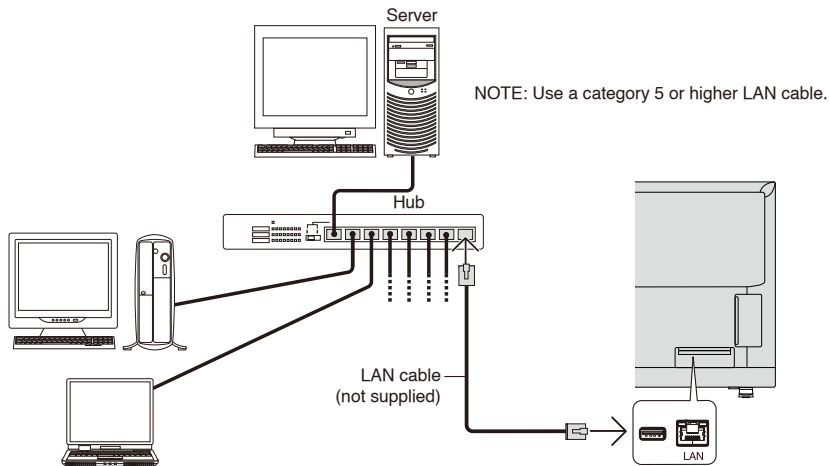

Network Setting by Using an HTTP Browser

Overview

Connecting the monitor to a network allows for monitor control from a computer via the network.

The IP address and subnet mask of the monitor can be set on the Network Setting screen of the web browser by using an HTTP server. Please be sure to use "Microsoft Internet Explorer 10" or a higher version for the web browser.

(This device uses "JavaScript" and "Cookies" and the browser should be set to accept these functions. The setting method will vary depending on the version of the browser. Please refer to the help files and the other information provided in your software.)

Access is gained to the HTTP server function by starting the Web browser on the computer via the network connected to the monitor and entering the following URL as described below:

Network Setting

`http://<the Monitor's IP address>/index.html`

HINT: The default IP address is assigned automatically to the monitor.
The exclusive application can be downloaded from our website.

NOTE: If the MONITOR NETWORK SETTINGS screen does not appear in the web browser, press the Ctrl+F5 keys to refresh your web browser (or clear the cache).

If the monitor appears to be slow in response to commands or clicks on buttons in the browser, or the general speed of operation is unacceptable, this may be due to network traffic or the settings on your network. Should this happen, consult your network administrator.

The monitor may not respond if the buttons shown on the browser are repeatedly pressed in rapid intervals. Should this happen, wait a moment and repeat. If you still can't get a response, turn the monitor off and then back on.

To control a monitor please use the control command. See "Control command diagram" (page 50)

Supporting HDMI CEC command

HDMI CEC command name	Explanation
One Touch Play	If HDMI CEC supporting devices are turned on, the monitor connected to the devices by HDMI cable is also turned on automatically. After that, the input switches to HDMI from an input, which you selected. If the monitor is turned on when HDMI CEC devices are turned on, it changes the input from the original one to HDMI.
Remote Control Pass Through	The monitor's wireless remote control button operation is functioning to HDMI CEC supporting devices. For example, if turning on the monitor by wireless remote control and pressing the play button, HDMI CEC supporting devices will also be turned on and play.
Power Status	Connected HDMI CEC supporting devices obtains the monitor's power status, such as the monitor is in standby mode or on.
System Information	This function obtains the information of a connected HDMI CEC supported device (CEC version, Physical Address). In addition, this function copes with "Change Language function". If the language for the monitor is changed, the language for a connected HDMI CEC supported device is changed to the same language, which is selected for the monitor. For the "Change Language function", it is necessary that the connected HDMI CEC supported device be able to cope with multi-language.
System Standby	If the monitor is set to standby using the wireless remote control supplied with the monitor, HDMI CEC supported devices also go into standby at the same time. If the monitor goes into standby while an HDMI CEC supported device is recording, the device is kept on. Please refer to the user's manual supplied with the HDMI CEC supported device for further information.
System Audio Control	The function sends digital audio signal through the HDMI cable. Please set an HDMI CEC audio amplifier between the monitor and an HDMI CEC supported device with an HDMI cable. The Volume button on the wireless remote control supplied with the monitor is also controlling the volume of the connected HDMI CEC audio amplifier. While this function is active, the internal speaker is set to MUTE automatically.
Device OSD Name Transfer	This function obtains the connected HDMI CEC supported device's name.
Routing Control	By selecting a device name, the HDMI CEC supported device input switches to the input you selected. After selecting the device, wireless remote control operation is functioning for the selected device.

CEC is an abbreviation of Consumer Electronics Control.

NOTE:

- Depending on the connected device, sometimes the device does not work properly.

Before Calling Service

Please make these simple checks before calling service. These tips may save you time and money as charges for receiver installation and adjustments of customer controls are not covered under your warranty.

Symptoms	Items To Check And Actions To Follow
"Ghost" or double image when using the tuner	<ul style="list-style-type: none"> This may be caused by an obstruction to the antenna due to high rise buildings or hills. Using a highly directional antenna may improve the picture.
No power	<ul style="list-style-type: none"> Check to see if the TV's AC power cord is plugged into the outlet. Unplug the TV and after 60 seconds reinsert the plug into the outlet and power on the TV.
No picture	<ul style="list-style-type: none"> At the rear of the TV make sure the antenna connection is properly attached. Check to see if there is a station broadcast problem by trying multiple channels. Adjust the contrast and brightness settings. Check the Closed Caption settings as some text modes may block the visibility of the images on the TV. Change setting of HDMI Signal Option at OSD
Good picture but no sound	<ul style="list-style-type: none"> Increase the volume. Confirm that the TV is not muted by pressing the Mute button on the remote control. Change setting of HDMI Signal Option at OSD
Good sound but poor color	<ul style="list-style-type: none"> Adjust the contrast, color and brightness settings.
Poor picture	<ul style="list-style-type: none"> Poor picture quality may occur when an activated S-VHS camera or camcorder is connected to your TV and another peripheral at the same time. Switch off one of the peripherals. Change setting of MEMC at OSD (Only for E557Q / E657Q)
Snowy picture and noise when using the tuner	<ul style="list-style-type: none"> Check the antenna connection and signal.
Presence of a horizontal dotted line	<ul style="list-style-type: none"> This may be caused by electrical interference (e.g. hairdryer, nearby neon lights, etc.). Power cycle the equipment by turning off and then turning back on.
TV not responding via the remote control	<ul style="list-style-type: none"> Determine if the batteries are working and replace batteries if necessary. Clean the remote control sensor lens on the TV. If necessary, utilize the buttons located on the side of the TV. Select the TV mode to ensure your remote control is set in the TV mode.
RS-232C or LAN control is not available	<ul style="list-style-type: none"> Check RS-232C (reverse type) or the LAN cable. A category 5 or higher LAN cable is required for connection. Please use shielded cable.

Glossary

HDTV

HDTV displays are technically defined as being capable of displaying a minimum of 720p or 1080i active scan lines.

HDMI Inputs

High-Definition Multimedia Interface Audio / Video Inputs are located on the receiver. These connectors are used for the input of audio and video signals. Designed to receive higher picture resolution and offer sound connection options.

Menu

An on-screen listing of features shown on the TV screen is made available for user adjustments.

RF

Radio Frequency or modulated signal design used by the carrier for television broadcasts.

Second Audio Program (SAP)

Another or additional audio channel provided for in the Multichannel Television Sound (MTS) broadcast standard. A monaural soundtrack included within the recorded or video signal (usually containing a second language translation for the displayed program).

Sleep Timer

You can set a time period for which the TV will automatically turn off.

[Notice] About the MPEG-4 AVC, MPEG-4 Visual license included in this product

1. MPEG-4 AVC

THIS PRODUCT IS LICENSED UNDER THE AVC PATENT PORTFOLIO LICENSE FOR THE PERSONAL USE OF A CONSUMER OR OTHER USES IN WHICH IT DOES NOT RECEIVE REMUNERATION TO (i) ENCODE VIDEO IN COMPLIANCE WITH THE AVC STANDARD ("AVC VIDEO") AND/OR (ii) DECODE AVC VIDEO THAT WAS ENCODED BY A CONSUMER ENGAGED IN A PERSONAL ACTIVITY AND/OR WAS OBTAINED FROM A VIDEO PROVIDER LICENSED TO PROVIDE AVC VIDEO. NO LICENSE IS GRANTED OR SHALL BE IMPLIED FOR ANY OTHER USE. ADDITIONAL INFORMATION MAY BE OBTAINED FROM MPEG LA, L.L.C. SEE [HTTP://WWW.MPEGLA.COM](http://WWW.MPEGLA.COM)

2. MPEG-4 Visual

THIS PRODUCT IS LICENSED UNDER THE MPEG-4 VISUAL PATENT PORTFOLIO LICENSE FOR THE PERSONAL AND NON-COMMERCIAL USE OF A CONSUMER FOR (i) ENCODING VIDEO IN COMPLIANCE WITH THE MPEG-4 VISUAL STANDARD ("MPEG-4 VIDEO") AND/OR (ii) DECODING MPEG-4 VIDEO THAT WAS ENCODED BY A CONSUMER ENGAGED IN A PERSONAL AND NONCOMMERCIAL ACTIVITY AND/OR WAS OBTAINED FROM A VIDEO PROVIDER LICENSED BY MPEG LA TO PROVIDE MPEG-4 VIDEO. NO LICENSE IS GRANTED OR SHALL BE IMPLIED FOR ANY OTHER USE. ADDITIONAL INFORMATION INCLUDING THAT RELATING TO PROMOTIONAL, INTERNAL AND COMMERCIAL USES AND LICENSING MAY BE OBTAINED FROM MPEG LA, LLC. SEE [HTTP://WWW.MPEGLA.COM](http://WWW.MPEGLA.COM).

GPL/LGPL Software Licenses Used by the Product

Thank you for purchasing an NEC product.

1. GPL/LGPL software

The product includes software licensed under GNU General Public License (GPL) or GNU Lesser General Public License (LGPL).

We disclose the software's source codes so that you may get, copy, distribute and modify it licensed under GPL or LGPL.

For the full text of GPL and LGPL, refer to page 85 and later.

- We cannot answer any question relating to the contents of the source codes.
- There is no guarantee or warranty for the disclosed GPL/LGPL software per se, which does not influence the conditions of the warranty or guarantee for the product.

[Getting the source codes]

Request the source codes from the following website.

https://form.nec.jp/nec-display/root_en/2755e4/Inquiry.do?fid=2755e4

The product includes software licensed under the licenses below.

For the license agreements below, refer to each document. (page 85 and later)

Open Source Software	Version	License
fontconfig	2.7.1	FontConfig
freetype	2.5.3	FreeType
icu	4.2.1	ICU
libjpeg	6b	IJG
libpng	1.2.32	PNG
openssl	0.9.8o	Apache 1.0 BSD
zlib	1.2.8	ZLIB

GNU GENERAL PUBLIC LICENSE

Version 2, June 1991

Copyright (C) 1989, 1991 Free Software Foundation, Inc.
51 Franklin Street, Fifth Floor, Boston, MA 02110-1301, USA

English

Everyone is permitted to copy and distribute verbatim copies of this license document, but changing it is not allowed.

Preamble

The licenses for most software are designed to take away your freedom to share and change it. By contrast, the GNU General Public License is intended to guarantee your freedom to share and change free software--to make sure the software is free for all its users. This General Public License applies to most of the Free Software Foundation's software and to any other program whose authors commit to using it. (Some other Free Software Foundation software is covered by the GNU Lesser General Public License instead.) You can apply it to your programs, too.

When we speak of free software, we are referring to freedom, not price. Our General Public Licenses are designed to make sure that you have the freedom to distribute copies of free software (and charge for this service if you wish), that you receive source code or can get it if you want it, that you can change the software or use pieces of it in new free programs; and that you know you can do these things.

To protect your rights, we need to make restrictions that forbid anyone to deny you these rights or to ask you to surrender the rights. These restrictions translate to certain responsibilities for you if you distribute copies of the software, or if you modify it.

For example, if you distribute copies of such a program, whether gratis or for a fee, you must give the recipients all the rights that you have. You must make sure that they, too, receive or can get the source code. And you must show them these terms so they know their rights.

We protect your rights with two steps: (1) copyright the software, and (2) offer you this license which gives you legal permission to copy, distribute and/or modify the software.

Also, for each author's protection and ours, we want to make certain that everyone understands that there is no warranty for this free software. If the software is modified by someone else and passed on, we want its recipients to know that what they have is not the original, so that any problems introduced by others will not reflect on the original authors' reputations.

Finally, any free program is threatened constantly by software patents. We wish to avoid the danger that redistributors of a free program will individually obtain patent licenses, in effect making the program proprietary. To prevent this, we have made it clear that any patent must be licensed for everyone's free use or not licensed at all.

The precise terms and conditions for copying, distribution and modification follow.

TERMS AND CONDITIONS FOR COPYING, DISTRIBUTION AND MODIFICATION

0. This License applies to any program or other work which contains a notice placed by the copyright holder saying it may be distributed under the terms of this General Public License. The "Program", below, refers to any such program or work, and a "work based on the Program" means either the Program or any derivative work under copyright law: that is to say, a work containing the Program or a portion of it, either verbatim or with modifications and/or translated into another language. (Hereinafter, translation is included without limitation in the term "modification".) Each licensee is addressed as "you".

Activities other than copying, distribution and modification are not covered by this License; they are outside its scope. The act of running the Program is not restricted, and the output from the Program is covered only if its contents constitute a work based on the Program (independent of having been made by running the Program). Whether that is true depends on what the Program does.

1. You may copy and distribute verbatim copies of the Program's source code as you receive it, in any medium, provided that you conspicuously and appropriately publish on each copy an appropriate copyright notice and disclaimer of warranty; keep intact all the notices that refer to this License and to the absence of any warranty; and give any other recipients of the Program a copy of this License along with the Program.

You may charge a fee for the physical act of transferring a copy, and you may at your option offer warranty protection in exchange for a fee.

2. You may modify your copy or copies of the Program or any portion of it, thus forming a work based on the Program, and copy and distribute such modifications or work under the terms of Section 1 above, provided that you also meet all of these conditions:

- a) You must cause the modified files to carry prominent notices stating that you changed the files and the date of any change.
- b) You must cause any work that you distribute or publish, that in whole or in part contains or is derived from the Program or any part thereof, to be licensed as a whole at no charge to all third parties under the terms of this License.
- c) If the modified program normally reads commands interactively when run, you must cause it, when started running for such interactive use in the most ordinary way, to print or display an announcement including an appropriate copyright notice and a notice that there is no warranty (or else, saying that you provide a warranty) and that users may redistribute the program under these conditions, and telling the user how to view a copy of this License. (Exception: if the Program itself is interactive but does not normally print such an announcement, your work based on the Program is not required to print an announcement.)

These requirements apply to the modified work as a whole. If identifiable sections of that work are not derived from the Program, and can be reasonably considered independent and separate works in themselves, then this License, and its terms, do not apply to those sections when you distribute them as separate works. But when you distribute the same sections as part of a whole which is a work based on the

Program, the distribution of the whole must be on the terms of this License, whose permissions for other licensees extend to the entire whole, and thus to each and every part regardless of who wrote it.

Thus, it is not the intent of this section to claim rights or contest your rights to work written entirely by you; rather, the intent is to exercise the right to control the distribution of derivative or collective works based on the Program.

In addition, mere aggregation of another work not based on the Program with the Program (or with a work based on the Program) on a volume of a storage or distribution medium does not bring the other work under the scope of this License.

3. You may copy and distribute the Program (or a work based on it, under Section 2) in object code or executable form under the terms of Sections 1 and 2 above provided that you also do one of the following:
 - a) Accompany it with the complete corresponding machine-readable source code, which must be distributed under the terms of Sections 1 and 2 above on a medium customarily used for software interchange; or,
 - b) Accompany it with a written offer, valid for at least three years, to give any third party, for a charge no more than your cost of physically performing source distribution, a complete machine-readable copy of the corresponding source code, to be distributed under the terms of Sections 1 and 2 above on a medium customarily used for software interchange; or,
 - c) Accompany it with the information you received as to the offer to distribute corresponding source code. (This alternative is allowed only for noncommercial distribution and only if you received the program in object code or executable form with such an offer, in accord with Subsection b above.)

The source code for a work means the preferred form of the work for making modifications to it. For an executable work, complete source code means all the source code for all modules it contains, plus any associated interface definition files, plus the scripts used to control compilation and installation of the executable. However, as a special exception, the source code distributed need not include anything that is normally distributed (in either source or binary form) with the major components (compiler, kernel, and so on) of the operating system on which the executable runs, unless that component itself accompanies the executable.

If distribution of executable or object code is made by offering access to copy from a designated place, then offering equivalent access to copy the source code from the same place counts as distribution of the source code, even though third parties are not compelled to copy the source along with the object code.

4. You may not copy, modify, sublicense, or distribute the Program except as expressly provided under this License. Any attempt otherwise to copy, modify, sublicense or distribute the Program is void, and will automatically terminate your rights under this License. However, parties who have received copies, or rights, from you under this License will not have their licenses terminated so long as such parties remain in full compliance.
5. You are not required to accept this License, since you have not signed it. However, nothing else grants you permission to modify or distribute the Program or its

derivative works. These actions are prohibited by law if you do not accept this License. Therefore, by modifying or distributing the Program (or any work based on the Program), you indicate your acceptance of this License to do so, and all its terms and conditions for copying, distributing or modifying the Program or works based on it.

6. Each time you redistribute the Program (or any work based on the Program), the recipient automatically receives a license from the original licensor to copy, distribute or modify the Program subject to these terms and conditions. You may not impose any further restrictions on the recipients' exercise of the rights granted herein. You are not responsible for enforcing compliance by third parties to this License.
7. If, as a consequence of a court judgment or allegation of patent infringement or for any other reason (not limited to patent issues), conditions are imposed on you (whether by court order, agreement or otherwise) that contradict the conditions of this License, they do not excuse you from the conditions of this License. If you cannot distribute so as to satisfy simultaneously your obligations under this License and any other pertinent obligations, then as a consequence you may not distribute the Program at all. For example, if a patent license would not permit royalty-free redistribution of the Program by all those who receive copies directly or indirectly through you, then the only way you could satisfy both it and this License would be to refrain entirely from distribution of the Program.

If any portion of this section is held invalid or unenforceable under any particular circumstance, the balance of the section is intended to apply and the section as a whole is intended to apply in other circumstances.

It is not the purpose of this section to induce you to infringe any patents or other property right claims or to contest validity of any such claims; this section has the sole purpose of protecting the integrity of the free software distribution system, which is implemented by public license practices. Many people have made generous contributions to the wide range of software distributed through that system in reliance on consistent application of that system; it is up to the author/donor to decide if he or she is willing to distribute software through any other system and a licensee cannot impose that choice.

This section is intended to make thoroughly clear what is believed to be a consequence of the rest of this License.

8. If the distribution and/or use of the Program is restricted in certain countries either by patents or by copyrighted interfaces, the original copyright holder who places the Program under this License may add an explicit geographical distribution limitation excluding those countries, so that distribution is permitted only in or among countries not thus excluded. In such case, this License incorporates the limitation as if written in the body of this License.
9. The Free Software Foundation may publish revised and/or new versions of the General Public License from time to time. Such new versions will be similar in spirit to the present version, but may differ in detail to address new problems or concerns.

Each version is given a distinguishing version number. If the Program specifies a version number of this License which applies to it and "any later version", you have

the option of following the terms and conditions either of that version or of any later version published by the Free Software Foundation. If the Program does not specify a version number of this License, you may choose any version ever published by the Free Software Foundation.

10. If you wish to incorporate parts of the Program into other free programs whose distribution conditions are different, write to the author to ask for permission. For software which is copyrighted by the Free Software Foundation, write to the Free Software Foundation; we sometimes make exceptions for this. Our decision will be guided by the two goals of preserving the free status of all derivatives of our free software and of promoting the sharing and reuse of software generally.

NO WARRANTY

11. BECAUSE THE PROGRAM IS LICENSED FREE OF CHARGE, THERE IS NO WARRANTY FOR THE PROGRAM, TO THE EXTENT PERMITTED BY APPLICABLE LAW. EXCEPT WHEN OTHERWISE STATED IN WRITING THE COPYRIGHT HOLDERS AND/OR OTHER PARTIES PROVIDE THE PROGRAM "AS IS" WITHOUT WARRANTY OF ANY KIND, EITHER EXPRESSED OR IMPLIED, INCLUDING, BUT NOT LIMITED TO, THE IMPLIED WARRANTIES OF MERCHANTABILITY AND FITNESS FOR A PARTICULAR PURPOSE. THE ENTIRE RISK AS TO THE QUALITY AND PERFORMANCE OF THE PROGRAM IS WITH YOU. SHOULD THE PROGRAM PROVE DEFECTIVE, YOU ASSUME THE COST OF ALL NECESSARY SERVICING, REPAIR OR CORRECTION.
12. IN NO EVENT UNLESS REQUIRED BY APPLICABLE LAW OR AGREED TO IN WRITING WILL ANY COPYRIGHT HOLDER, OR ANY OTHER PARTY WHO MAY MODIFY AND/OR REDISTRIBUTE THE PROGRAM AS PERMITTED ABOVE, BE LIABLE TO YOU FOR DAMAGES, INCLUDING ANY GENERAL, SPECIAL, INCIDENTAL OR CONSEQUENTIAL DAMAGES ARISING OUT OF THE USE OR INABILITY TO USE THE PROGRAM (INCLUDING BUT NOT LIMITED TO LOSS OF DATA OR DATA BEING RENDERED INACCURATE OR LOSSES SUSTAINED BY YOU OR THIRD PARTIES OR A FAILURE OF THE PROGRAM TO OPERATE WITH ANY OTHER PROGRAMS), EVEN IF SUCH HOLDER OR OTHER PARTY HAS BEEN ADVISED OF THE POSSIBILITY OF SUCH DAMAGES.

END OF TERMS AND CONDITIONS

How to Apply These Terms to Your New Programs

If you develop a new program, and you want it to be of the greatest possible use to the public, the best way to achieve this is to make it free software which everyone can redistribute and change under these terms.

To do so, attach the following notices to the program. It is safest to attach them to the start of each source file to most effectively convey the exclusion of warranty; and each file should have at least the "copyright" line and a pointer to where the full notice is found.

one line to give the program's name and an idea of what it does.
Copyright (C) yyyy name of author

This program is free software; you can redistribute it and/or modify it under the terms

of the GNU General Public License as published by the Free Software Foundation; either version 2 of the License, or (at your option) any later version.

This program is distributed in the hope that it will be useful, but WITHOUT ANY WARRANTY; without even the implied warranty of MERCHANTABILITY or FITNESS FOR A PARTICULAR PURPOSE. See the GNU General Public License for more details.

You should have received a copy of the GNU General Public License along with this program; if not, write to the Free Software Foundation, Inc., 51 Franklin Street, Fifth Floor, Boston, MA 02110-1301, USA.

Also add information on how to contact you by electronic and paper mail.

If the program is interactive, make it output a short notice like this when it starts in an interactive mode:

Gnomovision version 69, Copyright (C) year name of author

Gnomovision comes with ABSOLUTELY NO WARRANTY; for details type `show w`. This is free software, and you are welcome to redistribute it under certain conditions; type `show c` for details.

The hypothetical commands `show w` and `show c` should show the appropriate parts of the General Public License. Of course, the commands you use may be called something other than `show w` and `show c`; they could even be mouse-clicks or menu items--whatever suits your program.

You should also get your employer (if you work as a programmer) or your school, if any, to sign a "copyright disclaimer" for the program, if necessary. Here is a sample; alter the names:

Yoyodyne, Inc., hereby disclaims all copyright interest in the program `Gnomovision` (which makes passes at compilers) written by James Hacker.

signature of Ty Coon, 1 April 1989

Ty Coon, President of Vice

This General Public License does not permit incorporating your program into proprietary programs. If your program is a subroutine library, you may consider it more useful to permit linking proprietary applications with the library. If this is what you want to do, use the GNU Lesser General Public License instead of this License.

GNU GENERAL PUBLIC LICENSE

Version 3, 29 June 2007

Copyright © 2007 Free Software Foundation, Inc. <<http://fsf.org/>>

Everyone is permitted to copy and distribute verbatim copies of this license document, but changing it is not allowed.

Preamble

The GNU General Public License is a free, copyleft license for software and other kinds of works. The licenses for most software and other practical works are designed to take away your freedom to share and change the works. By contrast, the GNU General Public License is intended to guarantee your freedom to share and change all versions of a program--to make sure it remains free software for all its users. We, the Free Software Foundation, use the GNU General Public License for most of our software; it applies also to any other work released this way by its authors. You can apply it to your programs, too.

When we speak of free software, we are referring to freedom, not price. Our General Public Licenses are designed to make sure that you have the freedom to distribute copies of free software (and charge for them if you wish), that you receive source code or can get it if you want it, that you can change the software or use pieces of it in new free programs, and that you know you can do these things.

To protect your rights, we need to prevent others from denying you these rights or asking you to surrender the rights. Therefore, you have certain responsibilities if you distribute copies of the software, or if you modify it: responsibilities to respect the freedom of others.

For example, if you distribute copies of such a program, whether gratis or for a fee, you must pass on to the recipients the same freedoms that you received. You must make sure that they, too, receive or can get the source code. And you must show them these terms so they know their rights.

Developers that use the GNU GPL protect your rights with two steps: (1) assert copyright on the software, and (2) offer you this License giving you legal permission to copy, distribute and/or modify it.

For the developers' and authors' protection, the GPL clearly explains that there is no warranty for this free software. For both users' and authors' sake, the GPL requires that modified versions be marked as changed, so that their problems will not be attributed erroneously to authors of previous versions.

Some devices are designed to deny users access to install or run modified versions of the software inside them, although the manufacturer can do so. This is fundamentally incompatible with the aim of protecting users' freedom to change the software. The systematic pattern of such abuse occurs in the area of products for individuals to use, which is precisely where it is most unacceptable. Therefore, we have designed this version of the GPL to prohibit the practice for those products. If such problems arise substantially in other domains, we stand ready to extend this provision to those domains in future versions of the GPL, as needed to protect the freedom of users.

Finally, every program is threatened constantly by software patents. States should not allow patents to restrict development and use of software on general-purpose

computers, but in those that do, we wish to avoid the special danger that patents applied to a free program could make it effectively proprietary. To prevent this, the GPL assures that patents cannot be used to render the program non-free.

The precise terms and conditions for copying, distribution and modification follow.

TERMS AND CONDITIONS

0. Definitions.

“This License” refers to version 3 of the GNU General Public License.

“Copyright” also means copyright-like laws that apply to other kinds of works, such as semiconductor masks.

“The Program” refers to any copyrightable work licensed under this License. Each licensee is addressed as “you”. “Licensees” and “recipients” may be individuals or organizations.

To “modify” a work means to copy from or adapt all or part of the work in a fashion requiring copyright permission, other than the making of an exact copy. The resulting work is called a “modified version” of the earlier work or a work “based on” the earlier work.

A “covered work” means either the unmodified Program or a work based on the Program.

To “propagate” a work means to do anything with it that, without permission, would make you directly or secondarily liable for infringement under applicable copyright law, except executing it on a computer or modifying a private copy. Propagation includes copying, distribution (with or without modification), making available to the public, and in some countries other activities as well.

To “convey” a work means any kind of propagation that enables other parties to make or receive copies. Mere interaction with a user through a computer network, with no transfer of a copy, is not conveying.

An interactive user interface displays “Appropriate Legal Notices” to the extent that it includes a convenient and prominently visible feature that (1) displays an appropriate copyright notice, and (2) tells the user that there is no warranty for the work (except to the extent that warranties are provided), that licensees may convey the work under this License, and how to view a copy of this License. If the interface presents a list of user commands or options, such as a menu, a prominent item in the list meets this criterion.

1. Source Code.

The “source code” for a work means the preferred form of the work for making modifications to it. “Object code” means any non-source form of a work.

A “Standard Interface” means an interface that either is an official standard defined by a recognized standards body, or, in the case of interfaces specified for a particular programming language, one that is widely used among developers working in that language.

The “System Libraries” of an executable work include anything, other than the work as a whole, that (a) is included in the normal form of packaging a Major Component, but which is not part of that Major Component, and (b) serves only to enable use of the work with that Major Component, or to implement a Standard Interface for which an implementation is available to the public in source code form. A “Major Component”, in this context, means a major essential component (kernel, window system, and so

on) of the specific operating system (if any) on which the executable work runs, or a compiler used to produce the work, or an object code interpreter used to run it.

The “Corresponding Source” for a work in object code form means all the source code needed to generate, install, and (for an executable work) run the object code and to modify the work, including scripts to control those activities. However, it does not include the work’s System Libraries, or general-purpose tools or generally available free programs which are used unmodified in performing those activities but which are not part of the work. For example, Corresponding Source includes interface definition files associated with source files for the work, and the source code for shared libraries and dynamically linked subprograms that the work is specifically designed to require, such as by intimate data communication or control flow between those subprograms and other parts of the work.

The Corresponding Source need not include anything that users can regenerate automatically from other parts of the Corresponding Source.

The Corresponding Source for a work in source code form is that same work.

2. Basic Permissions.

All rights granted under this License are granted for the term of copyright on the Program, and are irrevocable provided the stated conditions are met. This License explicitly affirms your unlimited permission to run the unmodified Program. The output from running a covered work is covered by this License only if the output, given its content, constitutes a covered work. This License acknowledges your rights of fair use or other equivalent, as provided by copyright law.

You may make, run and propagate covered works that you do not convey, without conditions so long as your license otherwise remains in force. You may convey covered works to others for the sole purpose of having them make modifications exclusively for you, or provide you with facilities for running those works, provided that you comply with the terms of this License in conveying all material for which you do not control copyright. Those thus making or running the covered works for you must do so exclusively on your behalf, under your direction and control, on terms that prohibit them from making any copies of your copyrighted material outside their relationship with you.

Conveying under any other circumstances is permitted solely under the conditions stated below. Sublicensing is not allowed; section 10 makes it unnecessary.

3. Protecting Users’ Legal Rights From Anti-Circumvention Law.

No covered work shall be deemed part of an effective technological measure under any applicable law fulfilling obligations under article 11 of the WIPO copyright treaty adopted on 20 December 1996, or similar laws prohibiting or restricting circumvention of such measures.

When you convey a covered work, you waive any legal power to forbid circumvention of technological measures to the extent such circumvention is effected by exercising rights under this License with respect to the covered work, and you disclaim any intention to limit operation or modification of the work as a means of enforcing, against the work’s users, your or third parties’ legal rights to forbid circumvention of technological measures.

4. Conveying Verbatim Copies.

You may convey verbatim copies of the Program’s source code as you receive it, in any medium, provided that you conspicuously and appropriately publish on each copy an appropriate copyright notice; keep intact all notices stating that this License and

any non-permissive terms added in accord with section 7 apply to the code; keep intact all notices of the absence of any warranty; and give all recipients a copy of this License along with the Program.

You may charge any price or no price for each copy that you convey, and you may offer support or warranty protection for a fee.

5. Conveying Modified Source Versions.

You may convey a work based on the Program, or the modifications to produce it from the Program, in the form of source code under the terms of section 4, provided that you also meet all of these conditions:

- * a) The work must carry prominent notices stating that you modified it, and giving a relevant date.
- * b) The work must carry prominent notices stating that it is released under this License and any conditions added under section 7. This requirement modifies the requirement in section 4 to “keep intact all notices”.
- * c) You must license the entire work, as a whole, under this License to anyone who comes into possession of a copy. This License will therefore apply, along with any applicable section 7 additional terms, to the whole of the work, and all its parts, regardless of how they are packaged. This License gives no permission to license the work in any other way, but it does not invalidate such permission if you have separately received it.
- * d) If the work has interactive user interfaces, each must display Appropriate Legal Notices; however, if the Program has interactive interfaces that do not display Appropriate Legal Notices, your work need not make them do so.

A compilation of a covered work with other separate and independent works, which are not by their nature extensions of the covered work, and which are not combined with it such as to form a larger program, in or on a volume of a storage or distribution medium, is called an “aggregate” if the compilation and its resulting copyright are not used to limit the access or legal rights of the compilation’s users beyond what the individual works permit. Inclusion of a covered work in an aggregate does not cause this License to apply to the other parts of the aggregate.

6. Conveying Non-Source Forms.

You may convey a covered work in object code form under the terms of sections 4 and 5, provided that you also convey the machinereadable Corresponding Source under the terms of this License, in one of these ways:

- * a) Convey the object code in, or embodied in, a physical product (including a physical distribution medium), accompanied by the Corresponding Source fixed on a durable physical medium customarily used for software interchange.
- * b) Convey the object code in, or embodied in, a physical product (including a physical distribution medium), accompanied by a written offer, valid for at least three years and valid for as long as you offer spare parts or customer support for that product model, to give anyone who possesses the object code either (1) a copy of the Corresponding Source for all the software in the product that is covered by this License, on a durable physical medium customarily used for software interchange, for a price no more than your reasonable cost of physically performing this conveying of source, or (2) access to copy the Corresponding Source from a network server at no charge.
- * c) Convey individual copies of the object code with a copy of the written offer to provide the Corresponding Source. This alternative is allowed only occasionally

and noncommercially, and only if you received the object code with such an offer, in accord with subsection 6b.

- * d) Convey the object code by offering access from a designated place (gratis or for a charge), and offer equivalent access to the Corresponding Source in the same way through the same place at no further charge. You need not require recipients to copy the Corresponding Source along with the object code. If the place to copy the object code is a network server, the Corresponding Source may be on a different server (operated by you or a third party) that supports equivalent copying facilities, provided you maintain clear directions next to the object code saying where to find the Corresponding Source. Regardless of what server hosts the Corresponding Source, you remain obligated to ensure that it is available for as long as needed to satisfy these requirements.
- * e) Convey the object code using peer-to-peer transmission, provided you inform other peers where the object code and Corresponding Source of the work are being offered to the general public at no charge under subsection 6d.

A separable portion of the object code, whose source code is excluded from the Corresponding Source as a System Library, need not be included in conveying the object code work.

A “User Product” is either (1) a “consumer product”, which means any tangible personal property which is normally used for personal, family, or household purposes, or (2) anything designed or sold for incorporation into a dwelling. In determining whether a product is a consumer product, doubtful cases shall be resolved in favor of coverage. For a particular product received by a particular user, “normally used” refers to a typical or common use of that class of product, regardless of the status of the particular user or of the way in which the particular user actually uses, or expects or is expected to use, the product. A product is a consumer product regardless of whether the product has substantial commercial, industrial or non-consumer uses, unless such uses represent the only significant mode of use of the product.

“Installation Information” for a User Product means any methods, procedures, authorization keys, or other information required to install and execute modified versions of a covered work in that User Product from a modified version of its Corresponding Source. The information must suffice to ensure that the continued functioning of the modified object code is in no case prevented or interfered with solely because modification has been made.

If you convey an object code work under this section in, or with, or specifically for use in, a User Product, and the conveying occurs as part of a transaction in which the right of possession and use of the User Product is transferred to the recipient in perpetuity or for a fixed term (regardless of how the transaction is characterized), the Corresponding Source conveyed under this section must be accompanied by the Installation Information. But this requirement does not apply if neither you nor any third party retains the ability to install modified object code on the User Product (for example, the work has been installed in ROM).

The requirement to provide Installation Information does not include a requirement to continue to provide support service, warranty, or updates for a work that has been modified or installed by the recipient, or for the User Product in which it has been modified or installed.

Access to a network may be denied when the modification itself materially and adversely affects the operation of the network or violates the rules and protocols for communication across the network.

Corresponding Source conveyed, and Installation Information provided, in accord with this section must be in a format that is publicly documented (and with an

implementation available to the public in source code form), and must require no special password or key for unpacking, reading or copying.

7. Additional Terms.

“Additional permissions” are terms that supplement the terms of this License by making exceptions from one or more of its conditions. Additional permissions that are applicable to the entire Program shall be treated as though they were included in this License, to the extent that they are valid under applicable law. If additional permissions apply only to part of the Program, that part may be used separately under those permissions, but the entire Program remains governed by this License without regard to the additional permissions.

When you convey a copy of a covered work, you may at your option remove any additional permissions from that copy, or from any part of it. (Additional permissions may be written to require their own removal in certain cases when you modify the work.) You may place additional permissions on material, added by you to a covered work, for which you have or can give appropriate copyright permission.

Notwithstanding any other provision of this License, for material you add to a covered work, you may (if authorized by the copyright holders of that material) supplement the terms of this License with terms:

- * a) Disclaiming warranty or limiting liability differently from the terms of sections 15 and 16 of this License; or
- * b) Requiring preservation of specified reasonable legal notices or author attributions in that material or in the Appropriate Legal Notices displayed by works containing it; or
- * c) Prohibiting misrepresentation of the origin of that material, or requiring that modified versions of such material be marked in reasonable ways as different from the original version; or
- * d) Limiting the use for publicity purposes of names of licensors or authors of the material; or
- * e) Declining to grant rights under trademark law for use of some trade names, trademarks, or service marks; or
- * f) Requiring indemnification of licensors and authors of that material by anyone who conveys the material (or modified versions of it) with contractual assumptions of liability to the recipient, for any liability that these contractual assumptions directly impose on those licensors and authors.

All other non-permissive additional terms are considered “further restrictions” within the meaning of section 10. If the Program as you received it, or any part of it, contains a notice stating that it is governed by this License along with a term that is a further restriction, you may remove that term. If a license document contains a further restriction but permits relicensing or conveying under this License, you may add to a covered work material governed by the terms of that license document, provided that the further restriction does not survive such relicensing or conveying.

If you add terms to a covered work in accord with this section, you must place, in the relevant source files, a statement of the additional terms that apply to those files, or a notice indicating where to find the applicable terms.

Additional terms, permissive or non-permissive, may be stated in the form of a separately written license, or stated as exceptions; the above requirements apply either way.

8. Termination.

You may not propagate or modify a covered work except as expressly provided under this License. Any attempt otherwise to propagate or modify it is void, and will automatically terminate your rights under this License (including any patent licenses granted under the third paragraph of section 11).

However, if you cease all violation of this License, then your license from a particular copyright holder is reinstated (a) provisionally, unless and until the copyright holder explicitly and finally terminates your license, and (b) permanently, if the copyright holder fails to notify you of the violation by some reasonable means prior to 60 days after the cessation.

Moreover, your license from a particular copyright holder is reinstated permanently if the copyright holder notifies you of the violation by some reasonable means, this is the first time you have received notice of violation of this License (for any work) from that copyright holder, and you cure the violation prior to 30 days after your receipt of the notice.

Termination of your rights under this section does not terminate the licenses of parties who have received copies or rights from you under this License. If your rights have been terminated and not permanently reinstated, you do not qualify to receive new licenses for the same material under section 10.

9. Acceptance Not Required for Having Copies.

You are not required to accept this License in order to receive or run a copy of the Program. Ancillary propagation of a covered work occurring solely as a consequence of using peer-to-peer transmission to receive a copy likewise does not require acceptance. However, nothing other than this License grants you permission to propagate or modify any covered work. These actions infringe copyright if you do not accept this License. Therefore, by modifying or propagating a covered work, you indicate your acceptance of this License to do so.

10. Automatic Licensing of Downstream Recipients.

Each time you convey a covered work, the recipient automatically receives a license from the original licensors, to run, modify and propagate that work, subject to this License. You are not responsible for enforcing compliance by third parties with this License.

An “entity transaction” is a transaction transferring control of an organization, or substantially all assets of one, or subdividing an organization, or merging organizations. If propagation of a covered work results from an entity transaction, each party to that transaction who receives a copy of the work also receives whatever licenses to the work the party’s predecessor in interest had or could give under the previous paragraph, plus a right to possession of the Corresponding Source of the work from the predecessor in interest, if the predecessor has it or can get it with reasonable efforts.

You may not impose any further restrictions on the exercise of the rights granted or affirmed under this License. For example, you may not impose a license fee, royalty, or other charge for exercise of rights granted under this License, and you may not initiate litigation (including a cross-claim or counterclaim in a lawsuit) alleging that any patent claim is infringed by making, using, selling, offering for sale, or importing the Program or any portion of it.

11. Patents.

A “contributor” is a copyright holder who authorizes use under this License of the Program or a work on which the Program is based. The work thus licensed is called

the contributor's "contributor version".

A contributor's "essential patent claims" are all patent claims owned or controlled by the contributor, whether already acquired or hereafter acquired, that would be infringed by some manner, permitted by this License, of making, using, or selling its contributor version, but do not include claims that would be infringed only as a consequence of further modification of the contributor version. For purposes of this definition, "control" includes the right to grant patent sublicenses in a manner consistent with the requirements of this License.

Each contributor grants you a non-exclusive, worldwide, royalty-free patent license under the contributor's essential patent claims, to make, use, sell, offer for sale, import and otherwise run, modify and propagate the contents of its contributor version.

In the following three paragraphs, a "patent license" is any express agreement or commitment, however denominated, not to enforce a patent (such as an express permission to practice a patent or covenant not to sue for patent infringement). To "grant" such a patent license to a party means to make such an agreement or commitment not to enforce a patent against the party.

If you convey a covered work, knowingly relying on a patent license, and the Corresponding Source of the work is not available for anyone to copy, free of charge and under the terms of this License, through a publicly available network server or other readily accessible means, then you must either (1) cause the Corresponding Source to be so available, or (2) arrange to deprive yourself of the benefit of the patent license for this particular work, or (3) arrange, in a manner consistent with the requirements of this License, to extend the patent license to downstream recipients. "Knowingly relying" means you have actual knowledge that, but for the patent license, your conveying the covered work in a country, or your recipient's use of the covered work in a country, would infringe one or more identifiable patents in that country that you have reason to believe are valid.

If, pursuant to or in connection with a single transaction or arrangement, you convey, or propagate by procuring conveyance of, a covered work, and grant a patent license to some of the parties receiving the covered work authorizing them to use, propagate, modify or convey a specific copy of the covered work, then the patent license you grant is automatically extended to all recipients of the covered work and works based on it.

A patent license is "discriminatory" if it does not include within the scope of its coverage, prohibits the exercise of, or is conditioned on the non-exercise of one or more of the rights that are specifically granted under this License. You may not convey a covered work if you are a party to an arrangement with a third party that is in the business of distributing software, under which you make payment to the third party based on the extent of your activity of conveying the work, and under which the third party grants, to any of the parties who would receive the covered work from you, a discriminatory patent license (a) in connection with copies of the covered work conveyed by you (or copies made from those copies), or (b) primarily for and in connection with specific products or compilations that contain the covered work, unless you entered into that arrangement, or that patent license was granted, prior to 28 March 2007.

Nothing in this License shall be construed as excluding or limiting any implied license or other defenses to infringement that may otherwise be available to you under applicable patent law.

12. No Surrender of Others' Freedom.

If conditions are imposed on you (whether by court order, agreement or otherwise) that contradict the conditions of this License, they do not excuse you from the conditions of this License. If you cannot convey a covered work so as to satisfy simultaneously

your obligations under this License and any other pertinent obligations, then as a consequence you may not convey it at all. For example, if you agree to terms that obligate you to collect a royalty for further conveying from those to whom you convey the Program, the only way you could satisfy both those terms and this License would be to refrain entirely from conveying the Program.

13. Use with the GNU Affero General Public License.

Notwithstanding any other provision of this License, you have permission to link or combine any covered work with a work licensed under version 3 of the GNU Affero General Public License into a single combined work, and to convey the resulting work. The terms of this License will continue to apply to the part which is the covered work, but the special requirements of the GNU Affero General Public License, section 13, concerning interaction through a network will apply to the combination as such.

14. Revised Versions of this License.

The Free Software Foundation may publish revised and/or new versions of the GNU General Public License from time to time. Such new versions will be similar in spirit to the present version, but may differ in detail to address new problems or concerns.

Each version is given a distinguishing version number. If the Program specifies that a certain numbered version of the GNU General Public License “or any later version” applies to it, you have the option of following the terms and conditions either of that numbered version or of any later version published by the Free Software Foundation. If the Program does not specify a version number of the GNU General Public License, you may choose any version ever published by the Free Software Foundation.

If the Program specifies that a proxy can decide which future versions of the GNU General Public License can be used, that proxy’s public statement of acceptance of a version permanently authorizes you to choose that version for the Program.

Later license versions may give you additional or different permissions. However, no additional obligations are imposed on any author or copyright holder as a result of your choosing to follow a later version.

15. Disclaimer of Warranty.

THERE IS NO WARRANTY FOR THE PROGRAM, TO THE EXTENT PERMITTED BY APPLICABLE LAW. EXCEPT WHEN OTHERWISE STATED IN WRITING THE COPYRIGHT HOLDERS AND/OR OTHER PARTIES PROVIDE THE PROGRAM “AS IS” WITHOUT WARRANTY OF ANY KIND, EITHER EXPRESSED OR IMPLIED, INCLUDING, BUT NOT LIMITED TO, THE IMPLIED WARRANTIES OF MERCHANTABILITY AND FITNESS FOR A PARTICULAR PURPOSE. THE ENTIRE RISK AS TO THE QUALITY AND PERFORMANCE OF THE PROGRAM IS WITH YOU. SHOULD THE PROGRAM PROVE DEFECTIVE, YOU ASSUME THE COST OF ALL NECESSARY SERVICING, REPAIR OR CORRECTION.

16. Limitation of Liability.

IN NO EVENT UNLESS REQUIRED BY APPLICABLE LAW OR AGREED TO IN WRITING WILL ANY COPYRIGHT HOLDER, OR ANY OTHER PARTY WHO MODIFIES AND/OR CONVEYS THE PROGRAM AS PERMITTED ABOVE, BE LIABLE TO YOU FOR DAMAGES, INCLUDING ANY GENERAL, SPECIAL, INCIDENTAL OR CONSEQUENTIAL DAMAGES ARISING OUT OF THE USE OR INABILITY TO USE THE PROGRAM (INCLUDING BUT NOT LIMITED TO LOSS OF DATA OR DATA BEING RENDERED INACCURATE OR LOSSES SUSTAINED BY YOU OR THIRD PARTIES OR A FAILURE OF THE PROGRAM TO OPERATE WITH ANY OTHER PROGRAMS), EVEN IF SUCH HOLDER OR OTHER PARTY HAS BEEN ADVISED OF THE POSSIBILITY OF SUCH DAMAGES.

17. Interpretation of Sections 15 and 16.

If the disclaimer of warranty and limitation of liability provided above cannot be given local legal effect according to their terms, reviewing courts shall apply local law that most closely approximates an absolute waiver of all civil liability in connection with the Program, unless a warranty or assumption of liability accompanies a copy of the Program in return for a fee.

END OF TERMS AND CONDITIONS

How to Apply These Terms to Your New Programs

If you develop a new program, and you want it to be of the greatest possible use to the public, the best way to achieve this is to make it free software which everyone can redistribute and change under these terms.

To do so, attach the following notices to the program. It is safest to attach them to the start of each source file to most effectively state the exclusion of warranty; and each file should have at least the "copyright" line and a pointer to where the full notice is found.

<one line to give the program's name and a brief idea of what it does.>

Copyright (C) <year> <name of author>

This program is free software: you can redistribute it and/or modify it under the terms of the GNU General Public License as published by the Free Software Foundation, either version 3 of the License, or (at your option) any later version.

This program is distributed in the hope that it will be useful, but WITHOUT ANY WARRANTY; without even the implied warranty of MERCHANTABILITY or FITNESS FOR A PARTICULAR PURPOSE. See the GNU General Public License for more details.

You should have received a copy of the GNU General Public License along with this program. If not, see <<http://www.gnu.org/licenses/>>.

Also add information on how to contact you by electronic and paper mail.

If the program does terminal interaction, make it output a short notice like this when it starts in an interactive mode:

<program> Copyright (C) <year> <name of author>

This program comes with ABSOLUTELY NO WARRANTY; for details type `show w`.

This is free software, and you are welcome to redistribute it under certain conditions; type `show c` for details.

The hypothetical commands `show w` and `show c` should show the appropriate parts of the General Public License. Of course, your program's commands might be different; for a GUI interface, you would use an "about box".

You should also get your employer (if you work as a programmer) or school, if any, to sign a "copyright disclaimer" for the program, if necessary. For more information on this, and how to apply and follow the GNU GPL, see <<http://www.gnu.org/licenses/>>.

The GNU General Public License does not permit incorporating your program into proprietary programs. If your program is a subroutine library, you may consider it more useful to permit linking proprietary applications with the library. If this is what you want to do, use the GNU Lesser General Public License instead of this License. But first, please read <<http://www.gnu.org/philosophy/why-not-lgpl.html>>.

GNU LESSER GENERAL PUBLIC LICENSE

Version 2.1, February 1999

Copyright (C) 1991, 1999 Free Software Foundation, Inc.

51 Franklin Street, Fifth Floor, Boston, MA 02110-1301 USA

Everyone is permitted to copy and distribute verbatim copies of this license document, but changing it is not allowed.

[This is the first released version of the Lesser GPL. It also counts as the successor of the GNU Library Public License, version 2, hence the version number 2.1.]

Preamble

The licenses for most software are designed to take away your freedom to share and change it. By contrast, the GNU General Public Licenses are intended to guarantee your freedom to share and change free software--to make sure the software is free for all its users.

This license, the Lesser General Public License, applies to some specially designated software packages--typically libraries--of the Free Software Foundation and other authors who decide to use it. You can use it too, but we suggest you first think carefully about whether this license or the ordinary General Public License is the better strategy to use in any particular case, based on the explanations below.

When we speak of free software, we are referring to freedom of use, not price. Our General Public Licenses are designed to make sure that you have the freedom to distribute copies of free software (and charge for this service if you wish); that you receive source code or can get it if you want it; that you can change the software and use pieces of it in new free programs; and that you are informed that you can do these things.

To protect your rights, we need to make restrictions that forbid distributors to deny you these rights or to ask you to surrender these rights. These restrictions translate to certain responsibilities for you if you distribute copies of the library or if you modify it.

For example, if you distribute copies of the library, whether gratis or for a fee, you must give the recipients all the rights that we gave you. You must make sure that they, too, receive or can get the source code. If you link other code with the library, you must provide complete object files to the recipients, so that they can relink them with the library after making changes to the library and recompiling it. And you must show them these terms so they know their rights.

We protect your rights with a two-step method: (1) we copyright the library, and (2) we offer you this license, which gives you legal permission to copy, distribute and/or modify the library.

To protect each distributor, we want to make it very clear that there is no warranty for the free library. Also, if the library is modified by someone else and passed on, the recipients should know that what they have is not the original version, so that the original author's reputation will not be affected by problems that might be introduced by others.

Finally, software patents pose a constant threat to the existence of any free program. We wish to make sure that a company cannot effectively restrict the users of a free program by obtaining a restrictive license from a patent holder. Therefore, we insist that any patent license obtained for a version of the library must be consistent with the full freedom of use specified in this license.

Most GNU software, including some libraries, is covered by the ordinary GNU General

Public License. This license, the GNU Lesser General Public License, applies to certain designated libraries, and is quite different from the ordinary General Public License. We use this license for certain libraries in order to permit linking those libraries into non-free programs.

When a program is linked with a library, whether statically or using a shared library, the combination of the two is legally speaking a combined work, a derivative of the original library. The ordinary General Public License therefore permits such linking only if the entire combination fits its criteria of freedom. The Lesser General Public License permits more lax criteria for linking other code with the library.

We call this license the “Lesser” General Public License because it does Less to protect the user’s freedom than the ordinary General Public License. It also provides other free software developers Less of an advantage over competing non-free programs. These disadvantages are the reason we use the ordinary General Public License for many libraries. However, the Lesser license provides advantages in certain special circumstances.

For example, on rare occasions, there may be a special need to encourage the widest possible use of a certain library, so that it becomes a de-facto standard. To achieve this, non-free programs must be allowed to use the library. A more frequent case is that a free library does the same job as widely used non-free libraries. In this case, there is little to gain by limiting the free library to free software only, so we use the Lesser General Public License.

In other cases, permission to use a particular library in non-free programs enables a greater number of people to use a large body of free software. For example, permission to use the GNU C Library in non-free programs enables many more people to use the whole GNU operating system, as well as its variant, the GNU/Linux operating system.

Although the Lesser General Public License is Less protective of the users’ freedom, it does ensure that the user of a program that is linked with the Library has the freedom and the wherewithal to run that program using a modified version of the Library.

The precise terms and conditions for copying, distribution and modification follow. Pay close attention to the difference between a “work based on the library” and a “work that uses the library”. The former contains code derived from the library, whereas the latter must be combined with the library in order to run.

TERMS AND CONDITIONS FOR COPYING, DISTRIBUTION AND MODIFICATION

0. This License Agreement applies to any software library or other program which contains a notice placed by the copyright holder or other authorized party saying it may be distributed under the terms of this Lesser General Public License (also called “this License”). Each licensee is addressed as “you”.

A “library” means a collection of software functions and/or data prepared so as to be conveniently linked with application programs (which use some of those functions and data) to form executables.

The “Library”, below, refers to any such software library or work which has been distributed under these terms. A “work based on the Library” means either the Library or any derivative work under copyright law: that is to say, a work containing the Library or a portion of it, either verbatim or with modifications and/or translated straightforwardly into another language. (Hereinafter, translation is included without limitation in the term “modification”).

“Source code” for a work means the preferred form of the work for making modifications to it. For a library, complete source code means all the source code for all modules it contains, plus any associated interface definition files, plus the scripts used to control compilation and installation of the library.

Activities other than copying, distribution and modification are not covered by this License; they are outside its scope. The act of running a program using the Library is not restricted, and output from such a program is covered only if its contents constitute a work based on the Library (independent of the use of the Library in a tool for writing it). Whether that is true depends on what the Library does and what the program that uses the Library does.

1. You may copy and distribute verbatim copies of the Library’s complete source code as you receive it, in any medium, provided that you conspicuously and appropriately publish on each copy an appropriate copyright notice and disclaimer of warranty; keep intact all the notices that refer to this License and to the absence of any warranty; and distribute a copy of this License along with the Library.

You may charge a fee for the physical act of transferring a copy, and you may at your option offer warranty protection in exchange for a fee.

2. You may modify your copy or copies of the Library or any portion of it, thus forming a work based on the Library, and copy and distribute such modifications or work under the terms of Section 1 above, provided that you also meet all of these conditions:

- a) The modified work must itself be a software library.
- b) You must cause the files modified to carry prominent notices stating that you changed the files and the date of any change.
- c) You must cause the whole of the work to be licensed at no charge to all third parties under the terms of this License.
- d) If a facility in the modified Library refers to a function or a table of data to be supplied by an application program that uses the facility, other than as an argument passed when the facility is invoked, then you must make a good faith effort to ensure that, in the event an application does not supply such function or table, the facility still operates, and performs whatever part of its purpose remains meaningful.

(For example, a function in a library to compute square roots has a purpose that is entirely well-defined independent of the application. Therefore, Subsection 2d requires that any application-supplied function or table used by this function must be optional: if the application does not supply it, the square root function must still compute square roots.)

These requirements apply to the modified work as a whole. If identifiable sections of that work are not derived from the Library, and can be reasonably considered independent and separate works in themselves, then this License, and its terms, do not apply to those sections when you distribute them as separate works. But when you distribute the same sections as part of a whole which is a work based on the Library, the distribution of the whole must be on the terms of this License, whose permissions for other licensees extend to the entire whole, and thus to each and every part regardless of who wrote it.

Thus, it is not the intent of this section to claim rights or contest your rights to work written entirely by you; rather, the intent is to exercise the right to control the

distribution of derivative or collective works based on the Library.

In addition, mere aggregation of another work not based on the Library with the Library (or with a work based on the Library) on a volume of a storage or distribution medium does not bring the other work under the scope of this License.

3. You may opt to apply the terms of the ordinary GNU General Public License instead of this License to a given copy of the Library. To do this, you must alter all the notices that refer to this License, so that they refer to the ordinary GNU General Public License, version 2, instead of to this License. (If a newer version than version 2 of the ordinary GNU General Public License has appeared, then you can specify that version instead if you wish.) Do not make any other change in these notices.

Once this change is made in a given copy, it is irreversible for that copy, so the ordinary GNU General Public License applies to all subsequent copies and derivative works made from that copy.

This option is useful when you wish to copy part of the code of the Library into a program that is not a library.

4. You may copy and distribute the Library (or a portion or derivative of it, under Section 2) in object code or executable form under the terms of Sections 1 and 2 above provided that you accompany it with the complete corresponding machine-readable source code, which must be distributed under the terms of Sections 1 and 2 above on a medium customarily used for software interchange.

If distribution of object code is made by offering access to copy from a designated place, then offering equivalent access to copy the source code from the same place satisfies the requirement to distribute the source code, even though third parties are not compelled to copy the source along with the object code.

5. A program that contains no derivative of any portion of the Library, but is designed to work with the Library by being compiled or linked with it, is called a “work that uses the Library”. Such a work, in isolation, is not a derivative work of the Library, and therefore falls outside the scope of this License.

However, linking a “work that uses the Library” with the Library creates an executable that is a derivative of the Library (because it contains portions of the Library), rather than a “work that uses the library”. The executable is therefore covered by this License. Section 6 states terms for distribution of such executables.

When a “work that uses the Library” uses material from a header file that is part of the Library, the object code for the work may be a derivative work of the Library even though the source code is not. Whether this is true is especially significant if the work can be linked without the Library, or if the work is itself a library. The threshold for this to be true is not precisely defined by law.

If such an object file uses only numerical parameters, data structure layouts and accessors, and small macros and small inline functions (ten lines or less in length), then the use of the object file is unrestricted, regardless of whether it is legally a derivative work. (Executables containing this object code plus portions of the Library will still fall under Section 6.)

Otherwise, if the work is a derivative of the Library, you may distribute the object code for the work under the terms of Section 6. Any executables containing that work also fall under Section 6, whether or not they are linked directly with the Library itself.

6. As an exception to the Sections above, you may also combine or link a “work that uses the Library” with the Library to produce a work containing portions of the

Library, and distribute that work under terms of your choice, provided that the terms permit modification of the work for the customer's own use and reverse engineering for debugging such modifications.

You must give prominent notice with each copy of the work that the Library is used in it and that the Library and its use are covered by this License. You must supply a copy of this License. If the work during execution displays copyright notices, you must include the copyright notice for the Library among them, as well as a reference directing the user to the copy of this License. Also, you must do one of these things:

- a) Accompany the work with the complete corresponding machine-readable source code for the Library including whatever changes were used in the work (which must be distributed under Sections 1 and 2 above); and, if the work is an executable linked with the Library, with the complete machine-readable "work that uses the Library", as object code and/or source code, so that the user can modify the Library and then relink to produce a modified executable containing the modified Library. (It is understood that the user who changes the contents of definitions files in the Library will not necessarily be able to recompile the application to use the modified definitions.)
- b) Use a suitable shared library mechanism for linking with the Library. A suitable mechanism is one that (1) uses at run time a copy of the library already present on the user's computer system, rather than copying library functions into the executable, and (2) will operate properly with a modified version of the library, if the user installs one, as long as the modified version is interface-compatible with the version that the work was made with.
- c) Accompany the work with a written offer, valid for at least three years, to give the same user the materials specified in Subsection 6a, above, for a charge no more than the cost of performing this distribution.
- d) If distribution of the work is made by offering access to copy from a designated place, offer equivalent access to copy the above specified materials from the same place.
- e) Verify that the user has already received a copy of these materials or that you have already sent this user a copy.

For an executable, the required form of the "work that uses the Library" must include any data and utility programs needed for reproducing the executable from it. However, as a special exception, the materials to be distributed need not include anything that is normally distributed (in either source or binary form) with the major components (compiler, kernel, and so on) of the operating system on which the executable runs, unless that component itself accompanies the executable.

It may happen that this requirement contradicts the license restrictions of other proprietary libraries that do not normally accompany the operating system. Such a contradiction means you cannot use both them and the Library together in an executable that you distribute.

7. You may place library facilities that are a work based on the Library side-by-side in a single library together with other library facilities not covered by this License, and distribute such a combined library, provided that the separate distribution of the work based on the Library and of the other library facilities is otherwise permitted, and provided that you do these two things:

- a) Accompany the combined library with a copy of the same work based on the Library, uncombined with any other library facilities. This must be distributed under the terms of the Sections above.
 - b) Give prominent notice with the combined library of the fact that part of it is a work based on the Library, and explaining where to find the accompanying uncombined form of the same work.
8. You may not copy, modify, sublicense, link with, or distribute the Library except as expressly provided under this License. Any attempt otherwise to copy, modify, sublicense, link with, or distribute the Library is void, and will automatically terminate your rights under this License. However, parties who have received copies, or rights, from you under this License will not have their licenses terminated so long as such parties remain in full compliance.
 9. You are not required to accept this License, since you have not signed it. However, nothing else grants you permission to modify or distribute the Library or its derivative works. These actions are prohibited by law if you do not accept this License. Therefore, by modifying or distributing the Library (or any work based on the Library), you indicate your acceptance of this License to do so, and all its terms and conditions for copying, distributing or modifying the Library or works based on it.
 10. Each time you redistribute the Library (or any work based on the Library), the recipient automatically receives a license from the original licensor to copy, distribute, link with or modify the Library subject to these terms and conditions. You may not impose any further restrictions on the recipients' exercise of the rights granted herein. You are not responsible for enforcing compliance by third parties with this License.
 11. If, as a consequence of a court judgment or allegation of patent infringement or for any other reason (not limited to patent issues), conditions are imposed on you (whether by court order, agreement or otherwise) that contradict the conditions of this License, they do not excuse you from the conditions of this License. If you cannot distribute so as to satisfy simultaneously your obligations under this License and any other pertinent obligations, then as a consequence you may not distribute the Library at all. For example, if a patent license would not permit royalty-free redistribution of the Library by all those who receive copies directly or indirectly through you, then the only way you could satisfy both it and this License would be to refrain entirely from distribution of the Library.

If any portion of this section is held invalid or unenforceable under any particular circumstance, the balance of the section is intended to apply, and the section as a whole is intended to apply in other circumstances.

It is not the purpose of this section to induce you to infringe any patents or other property right claims or to contest validity of any such claims; this section has the sole purpose of protecting the integrity of the free software distribution system which is implemented by public license practices. Many people have made generous contributions to the wide range of software distributed through that system in reliance on consistent application of that system; it is up to the author/donor to decide if he or she is willing to distribute software through any other system and a licensee cannot impose that choice.

This section is intended to make thoroughly clear what is believed to be a consequence of the rest of this License.

12. If the distribution and/or use of the Library is restricted in certain countries either by patents or by copyrighted interfaces, the original copyright holder who places the Library under this License may add an explicit geographical distribution limitation excluding those countries, so that distribution is permitted only in or among countries not thus excluded. In such case, this License incorporates the limitation as if written in the body of this License.
13. The Free Software Foundation may publish revised and/or new versions of the Lesser General Public License from time to time. Such new versions will be similar in spirit to the present version, but may differ in detail to address new problems or concerns.

Each version is given a distinguishing version number. If the Library specifies a version number of this License which applies to it and “any later version”, you have the option of following the terms and conditions either of that version or of any later version published by the Free Software Foundation. If the Library does not specify a license version number, you may choose any version ever published by the Free Software Foundation.

14. If you wish to incorporate parts of the Library into other free programs whose distribution conditions are incompatible with these, write to the author to ask for permission. For software which is copyrighted by the Free Software Foundation, write to the Free Software Foundation; we sometimes make exceptions for this. Our decision will be guided by the two goals of preserving the free status of all derivatives of our free software and of promoting the sharing and reuse of software generally.

NO WARRANTY

15. BECAUSE THE LIBRARY IS LICENSED FREE OF CHARGE, THERE IS NO WARRANTY FOR THE LIBRARY, TO THE EXTENT PERMITTED BY APPLICABLE LAW. EXCEPT WHEN OTHERWISE STATED IN WRITING THE COPYRIGHT HOLDERS AND/OR OTHER PARTIES PROVIDE THE LIBRARY “AS IS” WITHOUT WARRANTY OF ANY KIND, EITHER EXPRESSED OR IMPLIED, INCLUDING, BUT NOT LIMITED TO, THE IMPLIED WARRANTIES OF MERCHANTABILITY AND FITNESS FOR A PARTICULAR PURPOSE. THE ENTIRE RISK AS TO THE QUALITY AND PERFORMANCE OF THE LIBRARY IS WITH YOU. SHOULD THE LIBRARY PROVE DEFECTIVE, YOU ASSUME THE COST OF ALL NECESSARY SERVICING, REPAIR OR CORRECTION.
16. IN NO EVENT UNLESS REQUIRED BY APPLICABLE LAW OR AGREED TO IN WRITING WILL ANY COPYRIGHT HOLDER, OR ANY OTHER PARTY WHO MAY MODIFY AND/OR REDISTRIBUTE THE LIBRARY AS PERMITTED ABOVE, BE LIABLE TO YOU FOR DAMAGES, INCLUDING ANY GENERAL, SPECIAL, INCIDENTAL OR CONSEQUENTIAL DAMAGES ARISING OUT OF THE USE OR INABILITY TO USE THE LIBRARY (INCLUDING BUT NOT LIMITED TO LOSS OF DATA OR DATA BEING RENDERED INACCURATE OR LOSSES SUSTAINED BY YOU OR THIRD PARTIES OR A FAILURE OF THE LIBRARY TO OPERATE WITH ANY OTHER SOFTWARE), EVEN IF SUCH HOLDER OR OTHER PARTY HAS BEEN ADVISED OF THE POSSIBILITY OF SUCH DAMAGES.

END OF TERMS AND CONDITIONS

How to Apply These Terms to Your New Libraries

If you develop a new library, and you want it to be of the greatest possible use to the public, we recommend making it free software that everyone can redistribute and change. You can do so by permitting redistribution under these terms (or, alternatively, under the terms of the ordinary General Public License).

To apply these terms, attach the following notices to the library. It is safest to attach them to the start of each source file to most effectively convey the exclusion of warranty; and each file should have at least the "copyright" line and a pointer to where the full notice is found.

one line to give the library's name and an idea of what it does.

Copyright (C) year name of author

This library is free software; you can redistribute it and/or modify it under the terms of the GNU Lesser General Public License as published by the Free Software Foundation; either version 2.1 of the License, or (at your option) any later version.

This library is distributed in the hope that it will be useful, but WITHOUT ANY WARRANTY; without even the implied warranty of MERCHANTABILITY or FITNESS FOR A PARTICULAR PURPOSE. See the GNU Lesser General Public License for more details.

You should have received a copy of the GNU Lesser General Public

License along with this library; if not, write to the Free Software

Foundation, Inc., 51 Franklin Street, Fifth Floor, Boston, MA 02110-1301 USA

Also add information on how to contact you by electronic and paper mail.

You should also get your employer (if you work as a programmer) or your school, if any, to sign a "copyright disclaimer" for the library, if necessary. Here is a sample; alter the names:

Yoyodyne, Inc., hereby disclaims all copyright interest in the library `Frob` (a library for tweaking knobs) written by James Random Hacker.

signature of Ty Coon, 1 April 1990

Ty Coon, President of Vice

That's all there is to it!

fontconfig/COPYING

Copyright © 2000,2001,2002,2003,2004,2006,2007 Keith Packard

Copyright © 2005 Patrick Lam

Copyright © 2009 Roozbeh Pournader

Copyright © 2008,2009 Red Hat, Inc.

Copyright © 2008 Danilo Šegan

Copyright © 2012 Google, Inc.

Permission to use, copy, modify, distribute, and sell this software and its documentation for any purpose is hereby granted without fee, provided that the above copyright notice appear in all copies and that both that copyright notice and this permission notice appear in supporting documentation, and that the name of the author(s) not be used in advertising or publicity pertaining to distribution of the software without specific, written prior permission. The authors make no representations about the suitability of this software for any purpose. It is provided "as is" without express or implied warranty.

THE AUTHOR(S) DISCLAIMS ALL WARRANTIES WITH REGARD TO THIS SOFTWARE, INCLUDING ALL IMPLIED WARRANTIES OF MERCHANTABILITY AND FITNESS, IN NO EVENT SHALL THE AUTHOR(S) BE LIABLE FOR ANY SPECIAL, INDIRECT OR CONSEQUENTIAL DAMAGES OR ANY DAMAGES WHATSOEVER RESULTING FROM LOSS OF USE, DATA OR PROFITS, WHETHER IN AN ACTION OF CONTRACT, NEGLIGENCE OR OTHER TORTIOUS ACTION, ARISING OUT OF OR IN CONNECTION WITH THE USE OR PERFORMANCE OF THIS SOFTWARE.

freetype

The FreeType 2 font engine is copyrighted work and cannot be used legally without a software license. In order to make this project usable to a vast majority of developers, we distribute it under two mutually exclusive open-source licenses.

This means that *you* must choose *one* of the two licenses described below, then obey all its terms and conditions when using FreeType 2 in any of your projects or products.

- The FreeType License, found in the file `FTL.TXT`, which is similar to the original BSD license *with* an advertising clause that forces you to explicitly cite the FreeType project in your product's documentation. All details are in the license file. This license is suited to products which don't use the GNU General Public License.
- The GNU General Public License version 2, found in `GPL.TXT` (any later version can be used also), for programs which already use the GPL. Note that the FTL is incompatible with the GPL due to its advertisement clause.

The contributed BDF and PCF drivers come with a license similar to that of the X Window System. It is compatible to the above two licenses (see file `src/bdf/README` and `src/pcf/README`).

The gzip module uses the zlib license (see `src/gzip/zlib.h`) which too is compatible to the above two licenses.

ICU License - ICU 1.8.1 and later

COPYRIGHT AND PERMISSION NOTICE

Copyright (c) 1995-2009 International Business Machines Corporation and others All rights reserved.

Permission is hereby granted, free of charge, to any person obtaining a copy of this software and associated documentation files (the "Software"), to deal in the Software without restriction, including without limitation the rights to use, copy, modify, merge, publish, distribute, and/or sell copies of the Software, and to permit persons to whom the Software is furnished to do so, provided that the above copyright notice(s) and this permission notice appear in all copies of the Software and that both the above copyright notice(s) and this permission notice appear in supporting documentation.

THE SOFTWARE IS PROVIDED "AS IS", WITHOUT WARRANTY OF ANY KIND, EXPRESS OR IMPLIED, INCLUDING BUT NOT LIMITED TO THE WARRANTIES OF MERCHANTABILITY, FITNESS FOR A PARTICULAR PURPOSE AND NONINFRINGEMENT OF THIRD PARTY RIGHTS. IN NO EVENT SHALL THE COPYRIGHT HOLDER OR HOLDERS INCLUDED IN THIS NOTICE BE LIABLE FOR ANY CLAIM, OR ANY SPECIAL INDIRECT OR CONSEQUENTIAL DAMAGES, OR ANY DAMAGES WHATSOEVER RESULTING FROM LOSS OF USE, DATA OR PROFITS, WHETHER IN AN ACTION OF CONTRACT, NEGLIGENCE OR OTHER TORTIOUS ACTION, ARISING OUT OF OR IN CONNECTION WITH THE USE OR PERFORMANCE OF THIS SOFTWARE.

Except as contained in this notice, the name of a copyright holder shall not be used in advertising or otherwise to promote the sale, use or other dealings in this Software without prior written authorization of the copyright holder.

libjpeg

Copyright (c) All rights reserved.

Redistribution and use in source and binary forms, with or without modification, are permitted provided that the following conditions are met:

Redistributions of source code must retain the above copyright notice, this list of conditions and the following disclaimer.

Redistributions in binary form must reproduce the above copyright notice, this list of conditions and the following disclaimer in the documentation and/or other materials provided with the distribution.

Neither the name of the <ORGANIZATION> nor the names of its contributors may be used to endorse or promote products derived from this software without specific prior written permission.

THIS SOFTWARE IS PROVIDED BY THE COPYRIGHT HOLDERS AND CONTRIBUTORS "AS IS" AND ANY EXPRESS OR IMPLIED WARRANTIES, INCLUDING, BUT NOT LIMITED TO, THE IMPLIED WARRANTIES OF MERCHANTABILITY AND FITNESS FOR A PARTICULAR PURPOSE ARE DISCLAIMED. IN NO EVENT SHALL THE COPYRIGHT HOLDER OR CONTRIBUTORS BE LIABLE FOR ANY DIRECT, INDIRECT, INCIDENTAL, SPECIAL, EXEMPLARY, OR CONSEQUENTIAL DAMAGES (INCLUDING, BUT NOT LIMITED TO, PROCUREMENT OF SUBSTITUTE GOODS OR SERVICES; LOSS OF USE, DATA, OR PROFITS; OR BUSINESS INTERRUPTION) HOWEVER CAUSED AND ON ANY THEORY OF LIABILITY, WHETHER IN CONTRACT, STRICT LIABILITY, OR TORT (INCLUDING NEGLIGENCE OR OTHERWISE) ARISING IN

ANY WAY OUT OF THE USE OF THIS SOFTWARE, EVEN IF ADVISED OF THE POSSIBILITY OF SUCH DAMAGE.

libpng

This copy of the libpng notices is provided for your convenience. In case of any discrepancy between this copy and the notices in the file png.h that is included in the libpng distribution, the latter shall prevail.

COPYRIGHT NOTICE, DISCLAIMER, and LICENSE:

If you modify libpng you may insert additional notices immediately following this sentence.

This code is released under the libpng license.

libpng versions 1.2.6, August 15, 2004, through 1.4.5, December 9, 2010, are Copyright (c) 2004, 2006-2010 Glenn Randers-Pehrson, and are distributed according to the same disclaimer and license as libpng-1.2.5 with the following individual added to the list of Contributing Authors

Cosmin Truta

libpng versions 1.0.7, July 1, 2000, through 1.2.5 - October 3, 2002, are Copyright (c) 2000-2002 Glenn Randers-Pehrson, and are distributed according to the same disclaimer and license as libpng-1.0.6 with the following individuals added to the list of Contributing Authors

Simon-Pierre Cadieux

Eric S. Raymond

Gilles Vollant

and with the following additions to the disclaimer:

There is no warranty against interference with your enjoyment of the library or against infringement. There is no warranty that our efforts or the library will fulfill any of your particular purposes or needs. This library is provided with all faults, and the entire risk of satisfactory quality, performance, accuracy, and effort is with the user.

libpng versions 0.97, January 1998, through 1.0.6, March 20, 2000, are Copyright (c) 1998, 1999 Glenn Randers-Pehrson, and are distributed according to the same disclaimer and license as libpng-0.96, with the following individuals added to the list of Contributing Authors:

Tom Lane

Glenn Randers-Pehrson

Willem van Schaik

libpng versions 0.89, June 1996, through 0.96, May 1997, are Copyright (c) 1996, 1997 Andreas Dilger Distributed according to the same disclaimer and license as libpng-0.88, with the following individuals added to the list of Contributing Authors:

John Bowler

Kevin Bracey

Sam Bushell

Magnus Holmgren

Greg Roelofs

Tom Tanner

libpng versions 0.5, May 1995, through 0.88, January 1996, are Copyright (c) 1995, 1996 Guy Eric Schalnat, Group 42, Inc.

For the purposes of this copyright and license, "Contributing Authors" is defined as the following set of individuals:

Andreas Dilger

Dave Martindale

Guy Eric Schalnat

Paul Schmidt

Tim Wegner

The PNG Reference Library is supplied "AS IS". The Contributing Authors and Group 42, Inc. disclaim all warranties, expressed or implied, including, without limitation, the warranties of merchantability and of fitness for any purpose. The Contributing Authors and Group 42, Inc. assume no liability for direct, indirect, incidental, special, exemplary, or consequential damages, which may result from the use of the PNG Reference Library, even if advised of the possibility of such damage.

Permission is hereby granted to use, copy, modify, and distribute this source code, or portions hereof, for any purpose, without fee, subject to the following restrictions:

1. The origin of this source code must not be misrepresented.
2. Altered versions must be plainly marked as such and must not be misrepresented as being the original source.
3. This Copyright notice may not be removed or altered from any source or altered source distribution.

The Contributing Authors and Group 42, Inc. specifically permit, without fee, and encourage the use of this source code as a component to supporting the PNG file format in commercial products. If you use this source code in a product, acknowledgment is not required but would be appreciated.

A "png_get_copyright" function is available, for convenient use in "about" boxes and the like:

```
printf("%s",png_get_copyright(NULL));
```

Also, the PNG logo (in PNG format, of course) is supplied in the files "pngbar.png" and "pngbar.jpg" (88x31) and "pngnow.png" (98x31).

Libpng is OSI Certified Open Source Software. OSI Certified Open Source is a certification mark of the Open Source Initiative.

Glenn Randers-Pehrson

glennrp at users.sourceforge.net

December 9, 2010

OpenSSL License

Copyright (c) 1998-2008 The OpenSSL Project. All rights reserved.

Redistribution and use in source and binary forms, with or without modification, are permitted provided that the following conditions are met:

1. Redistributions of source code must retain the above copyright notice, this list of conditions and the following disclaimer.
2. Redistributions in binary form must reproduce the above copyright notice, this list of conditions and the following disclaimer in the documentation and/or other materials provided with the distribution.
3. All advertising materials mentioning features or use of this software must display the following acknowledgment:
"This product includes software developed by the OpenSSL Project for use in the OpenSSL Toolkit. (<http://www.openssl.org/>)"
4. The names "OpenSSL Toolkit" and "OpenSSL Project" must not be used to endorse or promote products derived from this software without prior written permission. For written permission, please contact openssl-core@openssl.org.
5. Products derived from this software may not be called "OpenSSL" nor may "OpenSSL" appear in their names without prior written permission of the OpenSSL Project.
6. Redistributions of any form whatsoever must retain the following acknowledgment:
"This product includes software developed by the OpenSSL Project for use in the OpenSSL Toolkit (<http://www.openssl.org/>)"

THIS SOFTWARE IS PROVIDED BY THE OpenSSL PROJECT "AS IS" AND ANY EXPRESSED OR IMPLIED WARRANTIES, INCLUDING, BUT NOT LIMITED TO, THE IMPLIED WARRANTIES OF MERCHANTABILITY AND FITNESS FOR A PARTICULAR PURPOSE ARE DISCLAIMED. IN NO EVENT SHALL THE OpenSSL PROJECT OR ITS CONTRIBUTORS BE LIABLE FOR ANY DIRECT, INDIRECT, INCIDENTAL, SPECIAL, EXEMPLARY, OR CONSEQUENTIAL DAMAGES (INCLUDING, BUT NOT LIMITED TO, PROCUREMENT OF SUBSTITUTE GOODS OR SERVICES; LOSS OF USE, DATA, OR PROFITS; OR BUSINESS INTERRUPTION) HOWEVER CAUSED AND ON ANY THEORY OF LIABILITY, WHETHER IN CONTRACT, STRICT LIABILITY, OR TORT (INCLUDING NEGLIGENCE OR OTHERWISE) ARISING IN ANY WAY OUT OF THE USE OF THIS SOFTWARE, EVEN IF ADVISED OF THE POSSIBILITY OF SUCH DAMAGE.

This product includes cryptographic software written by Eric Young (ey@cryptsoft.com). This product includes software written by Tim Hudson (tjh@cryptsoft.com).

Original SSLeay License

Copyright (C) 1995-1998 Eric Young (ey@cryptsoft.com) All rights reserved.

This package is an SSL implementation written by Eric Young (ey@cryptsoft.com).

The implementation was written so as to conform with Netscapes SSL.

This library is free for commercial and non-commercial use as long as the following conditions are adhered to. The following conditions apply to all code found in this distribution, be it the RC4, RSA, lhash, DES, etc., code; not just the SSL code. The SSL documentation included with this distribution is covered by the same copyright terms except that the holder is Tim Hudson (tjh@cryptsoft.com).

Copyright remains Eric Young's, and as such any Copyright notices in the code are not to be removed.

If this package is used in a product, Eric Young should be given attribution as the author of the parts of the library used.

This can be in the form of a textual message at program startup or in documentation (online or textual) provided with the package.

Redistribution and use in source and binary forms, with or without modification, are permitted provided that the following conditions are met:

1. Redistributions of source code must retain the copyright notice, this list of conditions and the following disclaimer.
2. Redistributions in binary form must reproduce the above copyright notice, this list of conditions and the following disclaimer in the documentation and/or other materials provided with the distribution.
3. All advertising materials mentioning features or use of this software must display the following acknowledgement:
"This product includes cryptographic software written by Eric Young (eay@cryptsoft.com)"
The word 'cryptographic' can be left out if the routines from the library being used are not cryptographic related :-).
4. If you include any Windows specific code (or a derivative thereof) from the apps directory (application code) you must include an acknowledgement:
"This product includes software written by Tim Hudson (tjh@cryptsoft.com)"

THIS SOFTWARE IS PROVIDED BY ERIC YOUNG "AS IS" AND ANY EXPRESS OR IMPLIED WARRANTIES, INCLUDING, BUT NOT LIMITED TO, THE IMPLIED WARRANTIES OF MERCHANTABILITY AND FITNESS FOR A PARTICULAR PURPOSE ARE DISCLAIMED. IN NO EVENT SHALL THE AUTHOR OR CONTRIBUTORS BE LIABLE FOR ANY DIRECT, INDIRECT, INCIDENTAL, SPECIAL, EXEMPLARY, OR CONSEQUENTIAL DAMAGES (INCLUDING, BUT NOT LIMITED TO, PROCUREMENT OF SUBSTITUTE GOODS OR SERVICES; LOSS OF USE, DATA, OR PROFITS; OR BUSINESS INTERRUPTION)

HOWEVER CAUSED AND ON ANY THEORY OF LIABILITY, WHETHER IN CONTRACT, STRICT LIABILITY, OR TORT (INCLUDING NEGLIGENCE OR OTHERWISE) ARISING IN ANY WAY OUT OF THE USE OF THIS SOFTWARE, EVEN IF ADVISED OF THE POSSIBILITY OF SUCH DAMAGE.

The licence and distribution terms for any publically available version or derivative of this code cannot be changed. i.e. this code cannot simply be copied and put under another distribution licence

[including the GNU Public Licence.]

zlib License

This software is provided `as-is', without any express or implied warranty. In no event will the authors be held liable for any damages arising from the use of this software.

Permission is granted to anyone to use this software for any purpose, including commercial applications, and to alter it and redistribute it freely, subject to the following restrictions:

1. The origin of this software must not be misrepresented; you must not claim that you wrote the original software. If you use this software in a product, an acknowledgment in the product documentation would be appreciated but is not required.
2. Altered source versions must be plainly marked as such, and must not be misrepresented as being the original software.
3. This notice may not be removed or altered from any source distribution.