



MXW

Microflex[®] Wireless

Shure Microflex Wireless (MXW) online user guide with specifications and how to set up, install, network, and troubleshoot.
Version: 7.5 (2024-B)

Table of Contents

MXW Microflex® Wireless	4	High Density Mode	50
Overview	4	Configurations: Managing Multiple Groups	50
General Description	4	Wireless Management	51
Features	5	Overview of Channel Coordination	51
MXW Wireless System	6	Scanning Available RF Spectrum	52
Hardware Description	9	PHS Detection	53
Audio Network Interface (ANI)	10	Identifying PHS Detection Errors	53
Access Point Transceiver (APT)	13	Setting RF Power	54
Networked Charger (NCS)	15	Using Multiple 2- or 4-Channel Access Points	55
Microphone Transmitters	17	Networking	57
Rechargeable Batteries	22	Networking Best Practices	57
Installation	27	Configuring IP Settings	57
Additional Equipment	27	Advanced Setup	59
Connecting MXW Components	28	Software	62
Rack Installation	30	MXW System Control Software	62
Securing the Charging Station	30	Control Software for the MXW Audio Network Interface	76
Two-Channel Charger Wall Mount	31	Dante Software by Audinate	80
Mount the Access Point Transceiver	36	Firmware Updates	81
Power the Hardware	38	Troubleshooting	81
Open the MXW Control Software	40	Additional Resources	83
System Set Up	40	Factory Reset	83
Group Devices to Form Audio Channels	41	Accessories and Model Variations	84
Channel Routing between Devices	44	Microflex Wireless Specifications	87
Link Microphones to Group Channels	46	System	88
Preparing a Backup Microphone	47	Transmitters	88
Exchanging or Removing a Component	49	Access Point Transceiver (APT)	91
Link a Microphone Over the Network	49	Networked Charging Station (NCS)	92
Large Installations	50	Audio Network Interface (ANI)	93
Shure SystemOn Software For Managing Large Systems	50	Transmitter Output Power	95
0		Wiring Diagram	96

Important Safety Instructions	96	Important Product Information	98
Safety Information for Batteries	98	Information to the user	99
Storing Batteries	98	Certifications	100
		Trademarks	101

MXW Microflex[®] Wireless

Overview

General Description

The Shure Microflex Wireless Series (MXW) is a complete microphone solution for flexible meeting rooms and boardrooms. It features automatic RF channel management, rechargeable wireless microphones with encryption (AES256), and digital audio networking using Dante[™].

The MXW Access Point (APT) mounts to a ceiling or wall for discreet communication between the wireless microphones and the digital audio network. Multiple access points can be used for installations that require simultaneous operation of up to 80 microphones in the same area, depending on the region. The MXW networked charging station charges and stores boundary and gooseneck microphones for tabletop applications, as well as handheld and bodypack solutions for corporate training and presentations. Control software is used for system setup and remote monitoring and control from any computer connected to the network.



Features

Legendary Shure Quality

Premium Audio	All Microflex microphones are engineered to clearly capture the natural characteristics of voice communications, and include CommShield® Technology which guards against unwanted radio interference from consumer wireless devices such as cell phones and tablets.
Rechargeable Microphones	Each MXW microphone is powered from a rechargeable Lithium-ion battery, which can be charged at any time without removal from the microphone. Battery statistics are viewable from the control software (battery runtime, time to full charge, charge cycle count and battery capacity).
Discreet, Professional Design	Modern, low-profile wireless microphone designs elegantly integrate into diverse AV environments. By eliminating wires, MXW noticeably reduces clutter and provides professional elegance.
Encryption	The MXW wireless link is encrypted using the Advanced Encryption Standard (AES-256), as specified by the US Government National Institute of Standards and Technology (NIST) publication FIPS-197.

Advanced Networking and Control

Digital Audio Networking	Digital audio is carried over standard Ethernet using shielded Cat5e (or higher) cables. Developed with Dante™ technology by Audinate®, MXW provides low latency, clock synchronization, and high Quality-of-Service (QoS) to provide reliable audio transport. Digital audio can coexist safely on the same network as IT and control data, or can be configured to use a dedicated network.
Automatic Frequency Coordination	The MXW Series uses automatic frequency coordination to quickly set up all of the microphones and achieve reliable, uninterrupted wireless communication. Microphones are assigned to channels on an access point transceiver simply by arranging them in an associated charging station and pressing the Link button. Multiple access point transceivers can work together to support large installations or scalable rooms. Once Linked, the system automatically scans the available RF spectrum and selects the best quality RF channels on which to operate. Upon detecting interference, microphones automatically switch to the best alternate RF channel determined during continuous background scanning.
Remote Control and Monitoring	Microflex Wireless components and software are compatible with Crestron, AMX, and other programmable controllers. Components interconnect with teleconferencing equipment and digital signal processors.
Built-In RF Spectrum Scanner	The MXW Wireless components transmit in unlicensed spectrum that may be used by other wireless devices (in particular wireless phones and headsets) operating in the same area. The MXW access point features an RF scanner to document the average and peak RF interference. The data provides an accurate estimate for the number of MXW channels that can be safely operated in the scanned area.

MXW Wireless System

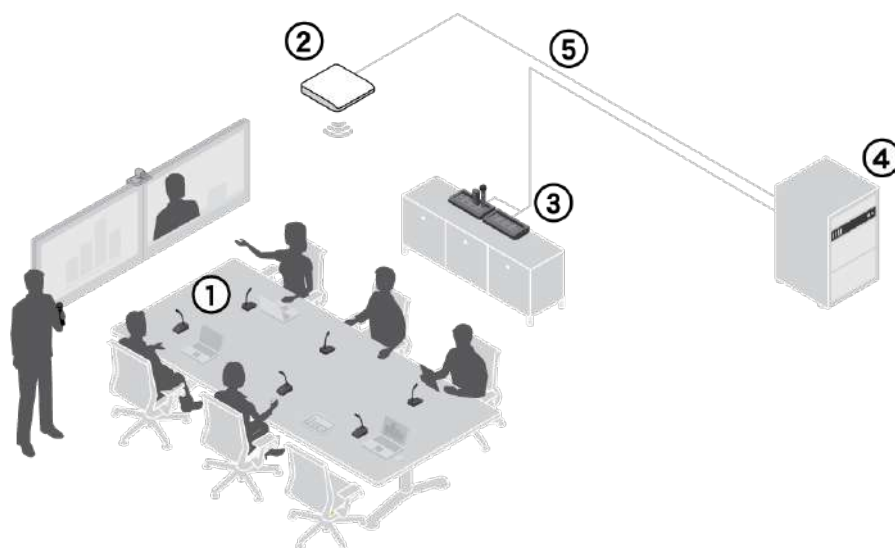

- ① Wireless Microphones
- ② System processor and wireless transceiver
- ③ Microphone linking and charging station
- ④ Analog output device with gigabit network switch
- ⑤ Shielded Cat5e cables (not included)

Components of the MXW System

Microphone Transmitters

MXW microphones transmit an encrypted, wireless audio signal to the access point. Four form factors are available:

Hybrid Bodypack (MXW1)	The bodypack secures to a belt or strap for hands-free, mobile communication. It features a TQG input for lavalier connection and an integrated omnidirectional microphone.
Handheld (MXW2)	The handheld enables presenters to communicate using legendary Shure SM58, SM86, BE-TA58 and VP68 microphone cartridges.
Boundary (MXW6/C, MXW6/O)	The boundary transmitter sits on a table or desk to transmit speech while discreetly blending into any conference environment.
Desktop Gooseneck Base (MXW8)	The gooseneck base is compatible with 5, 10, and 15" Microflex gooseneck microphones.

The MXW1, MXW6, and MXW8 microphones include a headphone output for monitoring audio, such as a translation channel.

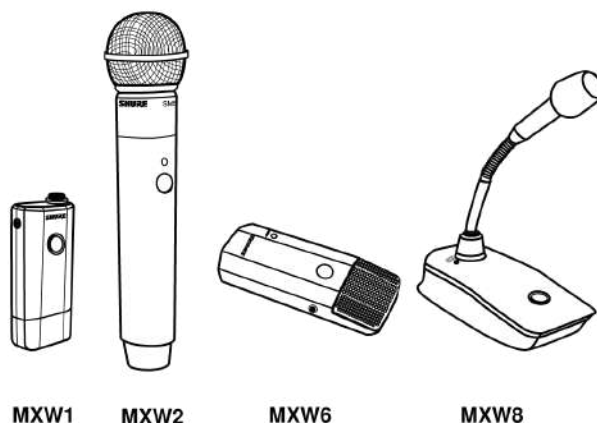

Access Point Transceiver (MXWAPT2, MXWAPT4, MXWAPT8)

The Access Point Transceiver (2, 4 and 8 channel units) mounts to a wall or ceiling to manage encrypted, wireless audio connections with microphones. As a system hub, it transports digital audio between the wireless microphones and other Dante devices on the same network.



Audio Network Interface (MXWANI4, MXWANI8)

The Audio Network Interface (4 and 8 channel) is a Dante network device that provides analog audio input and outputs for the MXW system. It has a 4-port Gigabit Ethernet switch that enables the connection of an MXW access point, a computer and up to two MXW networked charging stations.

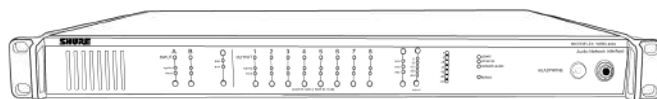

Networked Charging Station (MXWNCS2, MXWNCS4, MXWNCS8)

The Networked Charging Station (2, 4 and 8 slot varieties) is capable of simultaneous charging MXW microphones. It also links microphones to access point channels and networks battery statistics to the control software.

Note: The MXWNCS2 does not work with the MXW8 gooseneck microphones.

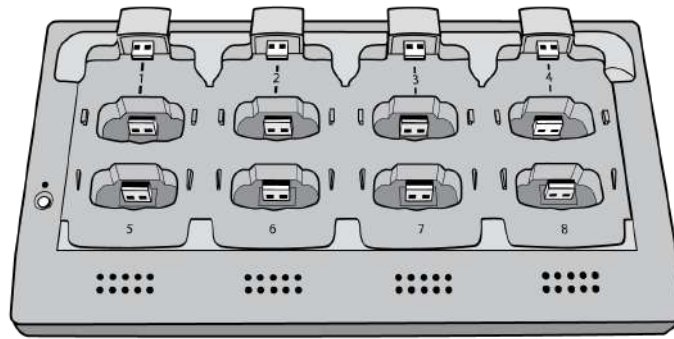

MXW Control Software

The MXW control software offers comprehensive remote control of key setup, monitoring and management functions.



System Design and Technology

Technology Overview of the Audio Path

The MXW System combines Shure legendary audio quality with advanced digital networking technology. The following is an overview of the audio path:

Wireless Audio

The MXW transmitter converts speech into a digital signal that is transmitted wirelessly to the access point.

- Intelligent, automatic wireless audio management using the Digital Enhanced Cordless Telecommunications (DECT) framework
- Custom RF design enables higher audio quality and lower latency than most DECT systems

Digital Audio Network

The access point receives wireless audio from the microphones and distributes it to the audio network interface.

- Low latency, tight clock synchronization, and high Quality-of-Service (QoS) provide reliable audio transport.
- Digital audio is carried over Ethernet cables and standard IP equipment.
- Audio coexists safely on the same network as IT and control data, or can be configured to use a dedicated network.

Analog Audio

The audio network interface converts network audio for each channel into analog outputs.

- Sends analog audio to a mixer, Digital Signal Processor (DSP), or teleconferencing device.

Forming Groups and Linking Microphones

Once all the MXW components are connected to the network, they can be associated into Groups from the Configuration tab of the control software. Each Access Point can form an association Group with one or two chargers (for Linking microphones) and one or two audio output devices (for routing audio to analog outputs). The microphones can then be placed in the charger and Linked to these access point channels.

Each Group is managed by a single access point. Microphones are Linked to channels in the access point, not to the charger that was used to Link them. This relationship persists until the microphones are re-Linked or the access point is reset.

Configurations: Managing Multiple Groups

Configurations allow multiple Groups to share the same preferences and global controls. When an additional Group is added to a Configuration page, a relationship is established across all devices in the configuration. The new Group will take on the settings of that configuration.

For specialized applications such as multiple room setup, several configurations can be created to independently control component Groups.

A Firmware Update May be Required

Shure periodically updates device firmware to add features and improve system performance. All devices in your system must operate the same firmware version for full functionality.

If your system is not functioning properly, download the appropriate application from the Shure website (<https://www.shure.com/firmware>) and update your devices to the latest firmware version. If you require further assistance, please contact [Shure Support](#).



Hardware Description

Audio Network Interface (ANI)

Front Panel

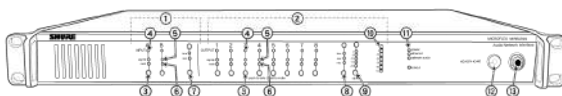

① Input Channels

Adds analog line- or aux-level signals to the digital network. When the device is associated to an MXW Group, inputs are automatically routed to Linked microphone channels (Input A to channels 1-4; Input B to 5-8).

② Output Channels

Converts digital network audio to an analog output for each channel. When associated to an MXW group, access point channels are automatically routed to the outputs of the ANI.

③ Channel Selector

Selects a channel to perform the following functions:

Action	Function
Single Press	Listen to that channel at the headphone jack Display and adjust the channel output level and attenuation Monitor output signal on the level meter
Press and Hold (3 seconds)	Mute/unmute a channel. Mute is indicated by the mute LED.

④ Selected Channel LED

Illuminates when a channel is selected.

⑤ Signal Strength LED (sig/clip)

Indicates audio signal strength for each channel:

- Green = Normal
- Amber = Strong
- Red = Clipping (to eliminate clipping, attenuate the signal level at the audio source)

⑥ Mute LED

Illuminates red when the channel output is muted (hold its channel select button for 3 seconds). A muted channel is still routed to the HEADPHONE jack for monitoring or troubleshooting.

⑦ Input Level Selector

Set the selected channel to line- or aux-level to match the input signal.

⑧ Output Level Selector

Set the selected channel to an output level that matches the connecting device:

- line: +4 dBu
- aux: -10 dBV
- mic: -30 dBV

⑨ Output Attenuation Control

Use the up/down buttons to attenuate the channel output from 0 dB (no attenuation) to -24 dB in 1 dB increments, and from -24 to -78 in 3 dB increments.

⑩ Level Meter

Displays a selected channel's audio level in dBFS. It is good practice to use -18 dBFS on the output meter as an approximation of 0 VU on an analog meter.

⑪ Hardware Status LEDs

Indicate the status of the hardware:

LED	Color	Status
Power	Green	Unit is powered on.
Ethernet	Green	Connected to an Ethernet device.
Network Audio	Green	All connected receive channels are OK (receiving digital audio as expected).
	Flashing Green	One or more connected receive channels experiencing a subscription error or is unresolved (transmitting device is off, disconnected, renamed or has incorrect network setting).
	Off	No receive channels connected (routing has not been established).
Lockout	Red	Front panel gain and mute controls are locked. The LED will blink when a button is pressed while the hardware is locked.

⑫ Headphone Volume Knob

Adjusts the volume to the headphone output.

⑬ Headphone Output

1/4" (6.35 mm) output jack for monitoring audio going to and from the digital audio network.

Note: Audio is present only when the unit is connected to a digital audio network.

Back Panel

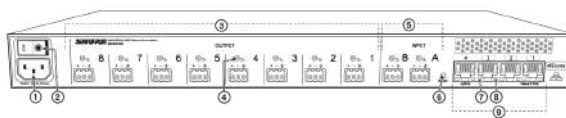

① AC Power

IEC connector 100 - 240 V AC.

② Power Switch

Powers the unit on or off.

③ Output Block Connectors (1-8)

Three-pin, low-voltage differential connector provides a line-, aux- or mic-level analog output for each channel.

④ Chassis Ground (1-8)

Use to directly ground the cable shield to the chassis.

⑤ Input Block Connectors (A,B)

Three-pin, low-voltage differential input connector adds line- or aux-level analog signals to the digital network.

Note: This input is meant for balanced connection. If an unbalanced source is used, such as an IPOD or MP3 player, only use pins 1 (signal) and 3 (ground) of the block connector. See Specifications sections for wiring diagrams.

⑥ Reset Button

Press and hold the button for five seconds to reboot the device with factory default settings.

⑦ Ethernet Status LED (Green)

- Off = no network link
- On = network link established
- Flashing = network link active

⑧ Ethernet Link Speed LED (Amber)

- Off = 10/100 Mbps
- On = 1 Gbps (required for digital audio routing)

⑨ Network Interface

Four-port gigabit switch for connecting components together for a single MXW Group, or for connecting multiple devices to a larger digital audio network. The following is a description of each port:

Port	Description
Port 1 (PoE)	Provides Power over Ethernet (PoE) for the Shure access point and functions as a standard gigabit port.

Port	Description
Ports 2 and 3	Standard gigabit ports enable the connection of another MXW network, additional MXWANIs, a MXWNCS charging stations or an external control system.
Port 4 (Uplink)	Normal mode (default): this port functions the same as ports 2 and 3. Uplink Mode: only transports control data. This mode blocks network audio and data for Shure Web Discovery Application, Dante Controller and Dante Virtual Soundcard.

Access Point Transceiver (APT)

The access point transceiver is the hub of the audio signal flow and manages the RF stability of each microphone in the group. The APT performs the following functions:

- Receives and decrypts wireless audio signals from microphones in the group
- Delivers the audio signal to the digital audio network and audio network interface (ANI)
- Sends and receives control information (such as gain adjustment and link settings) between the components, MXW control software and 3rd party controllers.
- Transmits an encrypted audio signal to the microphone's headphone output for listening to translated audio or other external sources.

Model Variations

MXWAPT8	Eight-channel transceiver
MXWAPT4	Four-channel transceiver
MXWAPT2	Two-channel transceiver

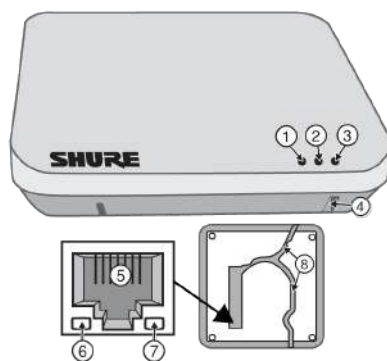

① Power LED

Illuminates green to indicate the presence of Power over Ethernet (PoE).

② Network Audio LED

Color	Status
Green	All routed receive channels are OK (receiving digital audio as expected).

Color	Status
Flashing Green	<p>One or more connected receive channels experiencing a subscription error or is unresolved (transmitting device is off, disconnected, renamed or has incorrect network setting).</p> <p>Receiving an Identification signal from the control software (simultaneous flash with Link Status LED).</p> <p>The device is performing a spectrum scan (alternating flash with Link Status LED).</p> <p>Clock synchronization problem.</p>
Off	No receive channels connected (routing has not been established).

Note: the network audio status can be monitored in detail from Dante Controller software.

③ Microphone Link Status LED

Color	Status
Green	≥1 microphone is linked and powered on in the Active, Mute or Standby state.
Off	≥1 microphone is linked and is Off or in a non-networked charger.
Red	No microphones have been linked.
Flashing Red	<p>Receiving an Identification signal from the control software (simultaneous flash with Network Audio LED).</p> <p>The device is performing a spectrum scan (alternating flash with Network Audio LED).</p>

④ Reset Button

Press and hold the reset button for 10 seconds to reset the MXW system to factory default settings.

Note: The reset deletes group association and microphone links, and will reboot the device in DHCP mode.

⑤ Ethernet Port

Connect a shielded Cat5e (or higher) cable to a PoE source and the network.

⑥ Ethernet Status LED (Green)

- Off = no network link
- On = network link established
- Flashing = network link active

⑦ Ethernet Link Speed LED (Amber)

- Off = 10/100 Mbps
- On = 1 Gbps (required for proper MXW functionality)

⑧ Cable Routing Path

Provides a path for the Ethernet cable to enable a flush-mount to the ceiling or wall.

Directional Antennas

The access point contains multiple directional antennas to provide steady, reliable wireless communication with the microphones. It sends and receives the RF signal in a cardioid pattern with the greatest sensitivity toward the face of the device. Always aim this side toward the microphone coverage area.

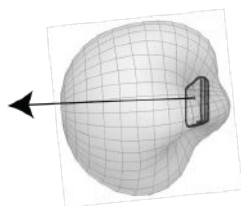

Cardioid RF Pattern

Networked Charger (NCS)

The MXW networked charging station enables battery charging and channel linking from a single location. When a charger is associated to a group, its channel slots are mapped to access point audio channels. Microphones can then be placed in the slots to Link to these channels.

Any microphone can recharge in any NCS, regardless of Group association or network connection.

Caution: When the Link button on an associated charger is pressed, all microphones in the charger are mapped to channels on an access point. This overrides any previously Linked microphones on those channels.

Model Variations

MXWNCS8	Accepts eight boundary, bodypack, or handheld microphones or four gooseneck bases
MXWNCS4	Accepts four boundary, bodypack, or handheld microphones or two gooseneck bases
MXWNCS2	Accepts two boundary, bodypack, or handheld microphones. MXW8 Gooseneck bases are not supported on this charger

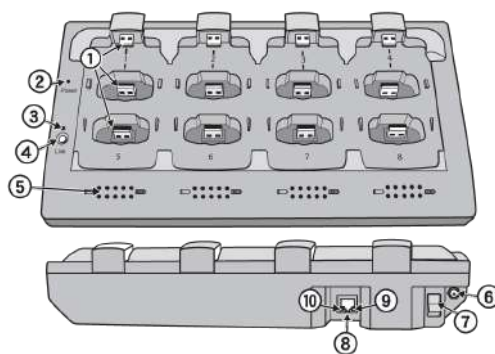

① Charging Slots (USB 3.0 Type A)

Recharge and link microphones by connecting them to the USB slots on the charger. When the charger is associated to a group, the slots are mapped to access point channels (See Audio Channel Assignment for details).

Note: Any microphone can charge in any charger, regardless of Group association or network connection.

② Power LED

Illuminates green when the unit is powered on.

③ Microphone Link LED

Indicates the status of the Linking procedure:

Color	Indicator
Off (default)	No Link has been initiated.
Flashing Green	Link procedure is in process.
Green	Microphones have been successfully linked to channels.
Red	Link procedure unsuccessful (RF issue, network failure, or microphones removed during procedure)
Amber	Link procedure cannot start because the station is not associated to a group.
Flashing Red	Link procedure has been locked from the control software.
Blue	Charger is in High Efficiency Mode.

④ Microphone Link Button

- Press and hold for 6 seconds to link all microphones in the charger to channels of the associated Access Point Transceiver.
- Within the first minute of powering up the charger, press and release the Link button 3 times in succession to place the charger in High Efficiency Mode. You must power cycle the charger to return to standard charging mode.

⑤ Battery Status LEDs

Monitors the charge status of the connected microphone in increments of <10, 10, 25, 50, 75, 100% (see Batteries for more detail). Additionally, the five LEDs flash for several seconds when the microphone has been successfully linked to the channel.

⑥ Locking DC Power Supply

Secures the PS60 power supply to the input jack of the station.

⑦ Power Switch

Powers the unit on or off.

⑧ Ethernet Port

Connects to the MXW System network through an MXW Audio Network Interface or a switch using an Ethernet cable.

⑨ Ethernet Status LED (Green)

- Off = no network link.
- On = network link established.
- Flashing = network link active.

⑩ Ethernet Link Speed LED (Amber)

- Off = 10 Mbps
- On = 100 Mbps

Connecting Microphones

Place a microphone in the charger by connecting it to one of the channel slots. The channels in the top row have two USB ports to accommodate different types of microphones. Do not attempt to connect to both USB ports at the same time.

Note: 2-channel chargers do not support gooseneck microphones.

- Handheld, boundary and bodypack: use the main vertical slots in the recessed bays.
- Gooseneck base: uses the top row's horizontal connectors.

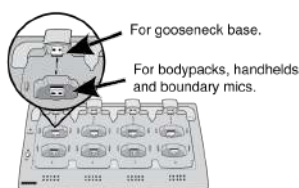

Different Connectors for the Same Channel

Microphone Transmitters

Description

① Power Button

MXW6, MXW8: Press and hold the dedicated power button for three seconds to turn the transmitter on or off.

MXW1, MXW2: Press and hold the Mute/Active button for five seconds to turn the transmitter on or off.

② Mute/Active Button

Changes the audio status from Active to Mute, or Mute to Active. The button behavior for each transmitter type can be set independently from the Preferences tab. The following describes the function of each setting:

- **Toggle:** Press and release the button to change the status to Active or Mute.
- **Push-to-talk:** Hold button to pass audio.
- **Push-to-mute:** Hold button to mute the audio.
- **Disabled:** The button does not affect the audio.

③ Status LED

Indicates the transmitter's status. The color indicators for Mute and Active can be customized from the Preferences tab. See the Status LED table for the default LED behavior for MXW transmitters except the gooseneck light-ring models (MX405R/410R/415R).

④ Low Battery LED (Gooseneck and Boundary only)

Color	Status
Off	>5% battery runtime remains
Solid Red	<5% battery runtime remains

⑤ Earphone Jack

1/8" (3.5 mm) jack for monitoring a return channel signal, such as translated audio. This audio is automatically routed from the input(s) of the Audio Network Interface (Input A to channels 1 - 4; Input B to channels 5 - 8).

Note: Not featured on the MXW2 handheld transmitter.

⑥ Charge Connector (USB 3.0 Type A)

Connects to the NCS charger slot or to the USB Charger.

⑦ Handheld Cartridge

MXW2 transmitter is compatible with the following cartridge types: SM58, Beta 58, SM86, VP68.

⑧ Gooseneck Microphone

The gooseneck base is compatible with 5, 10, and 15" Microflex gooseneck microphones.

⑧ TQG Connector

The MXW hybrid bodypack has a TQG connector for an external lavalier or headset microphone.

⑩ Internal Microphone

The bodypack transmitter has an internal, omnidirectional microphone that can be set to automatically engage when not connected to a lavalier microphone.

Status LED Table

Status	LED	Description
Active	Green	Ready to pass audio to network.
Mute	Red	Audio is muted.
Standby	Red Pulsing (long off, short on)	Audio is muted and the transmitter is in a hibernation state to conserve the battery.
Identify	Flashing Yellow	The Identify button has been pressed from the control software.
Initialization/ RF channel acquisition	Alternating Red and Green	The transmitter is initializing and acquiring the RF connection to the linked access point. Standard density mode has a slow alternating rate High density mode has a fast alternating rate
Out of RF Coverage Range	Red Pulsing (short on/off)	The transmitter is out of the RF coverage range to the linked access point.

Status	LED	Description
Charging	Off	The transmitter is charging.
Battery Statistics Reset	Flashing Yellow	Battery statistics have been reset for the transmitter.
Two microphones trying to connect to same audio channel	Red Pulsing (long on, short off)	Only one microphone for each audio channel can be active at a time.
Off	Off	No connection to the network. The transmitter must be turned on using the power button on the mic.

Microphone Transmitters

MXW microphones transmit an encrypted, wireless audio signal to the access point. Four form factors are available:

Hybrid Bodypack (MXW1)

The bodypack secures to a belt or strap for hands-free, mobile communication. It features a TQG input for lavalier microphone connection and an integrated omnidirectional microphone.

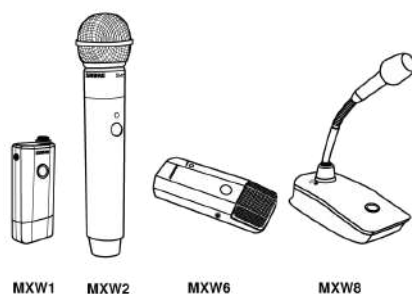

Wearing the Bodypack Transmitter

- Clip the transmitter to a belt or pocket.
- For best results, the belt should be pressed against the base of the clip.

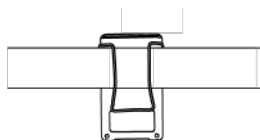

Handheld (MXW2)

The handheld enables presenters to communicate using legendary Shure SM58, SM86, BETA58 and VP68 microphone cartridges.

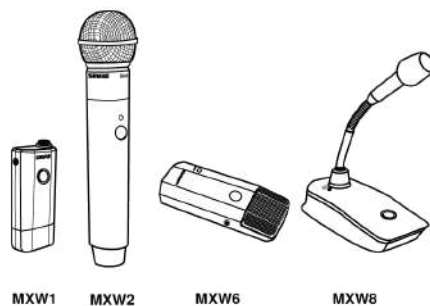

Correct Microphone Placement

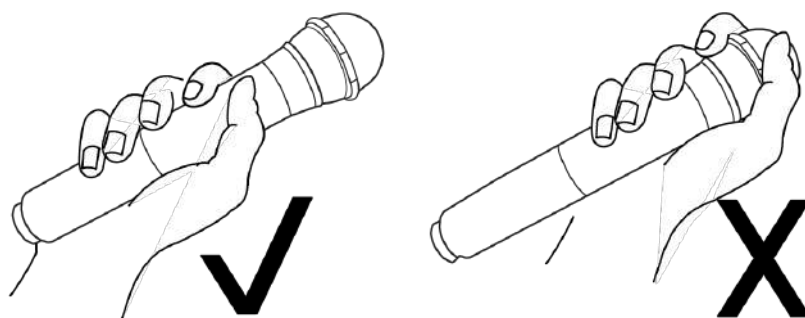

- Hold the microphone within 12 inches from the sound source. For a warmer sound with increased bass presence, move the microphone closer.
- Do not cover grille with hand.

Boundary (MXW6/C, MXW6/O)

The boundary transmitter sits on a table or desk to transmit speech while discreetly blending into any conference environment. Cardioid and omnidirectional versions are available.

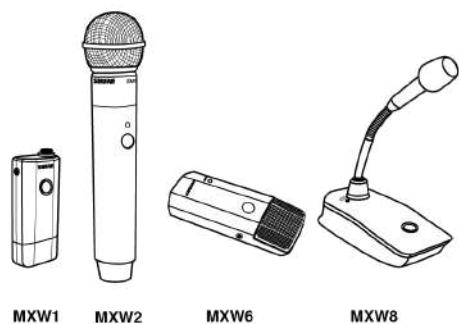

Microphone Placement

For best low-frequency response and rejection of background noise, place the microphone on a large, flat surface, such as a floor, table, or lectern.

To reduce reverberance, avoid reflective surfaces above or to the side of the microphone, such as beveled sides of pulpits or overhanging shelves.

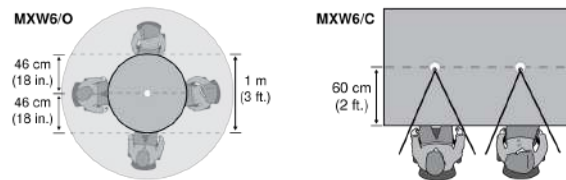

Desktop Gooseneck Base (MXW8)

The gooseneck base is compatible with 5, 10, and 15" Microflex gooseneck microphones.

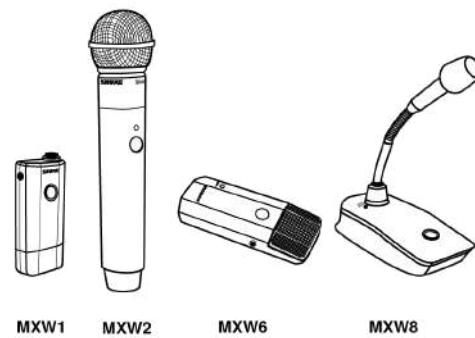

Microphone Types

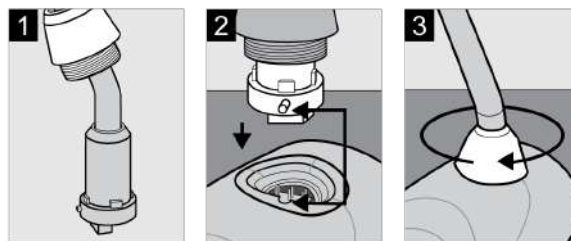

Insert Microphone into Base

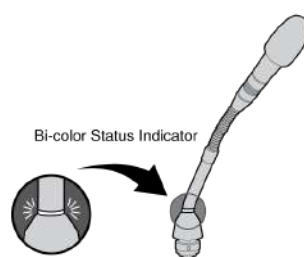

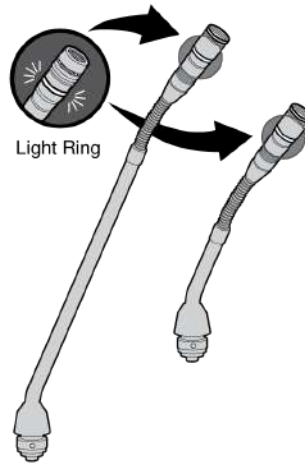
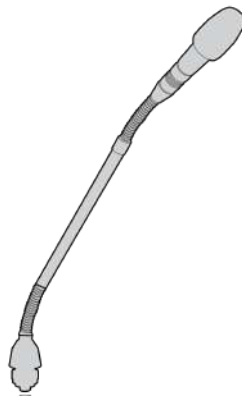
MX405, MX410 & MX415*Bi-color Status Indicator***MX405R, MX410R & MX415R***Light Ring***MX410DF, MX415DF***Dualflex*

Rechargeable Batteries

MXW lithium-ion rechargeable batteries use advanced chemistry that maximizes transmitter runtime. Power management from the control software provides detailed visibility to critical battery parameters such as charge status, battery capacity, and cycle count.

Batteries charge to 50% capacity in one hour and to full capacity in two hours using the MXW Networked Charging Station.

Models

Microphone Type	Battery Model
MXW1 bodypack	SB901A
MXW6 boundary	
MXW8 gooseneck base	
MXW2 handheld	SB902
	SB905*

* For MXW2 built after 12/2020

Networked Charging Station (NCS)

Slide the transmitter into the charging slot until it secures into place. The charge LEDs illuminate when the charge cycle begins. Regardless of Group association or network connection, any microphone can recharge in any NCS.

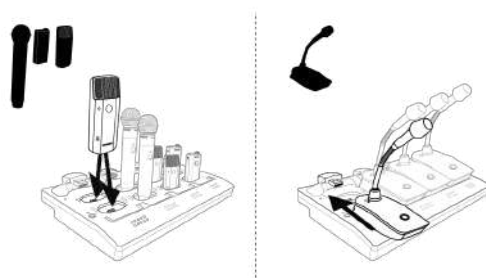

- Handheld, boundary and bodypack: use the main vertical slots in the recessed bays.
- Gooseneck base: uses the top row's horizontal connectors. (Not included on two-channel chargers).

Charge Status LEDs

Each charger channel has a row of LEDs that illuminate to indicate the microphone battery charge level:

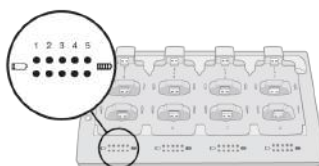

LED	% Battery Charge
1	Flashing: <10% Solid: >10%

LED	% Battery Charge
2	>25%
3	>50%
4	>75%
5	>95%

Note: The LEDs do not illuminate in Energy Efficient Mode.

NCS Power Modes

The charging station can be operated in different power modes other than standard charging mode:

Energy Efficient Mode

Operate the charger in a low-energy mode to reduce power consumption. In this mode, only one LED indicator illuminates per channel after powering on.

To change to Energy Efficient Mode:

1. Open the MXW control software to the Utility page.
2. Open the Device Properties window for the charging station.
3. Select the Energy Efficient Mode check-box.
4. Select Add updates to exit the device properties.
5. Select Apply All from the Utility page to push to your devices.

High Efficiency Mode

Operate the charger in high-efficiency mode to greatly reduce power consumption. In this mode:

- The Ethernet and charging LED indicators functions are disabled.
- The Power LED illuminates green.
- The Link LED illuminates blue, indicating High Efficiency Mode.

To change to High Efficiency Mode:

- Within the first minute of powering up the charger, press and release the Link button three times in succession.
- To return the charger to standard charging mode, power cycle the charger.

Notes:

- Shure rechargeable batteries require approximately 4 hours to fully recharge in High Efficiency Mode.

Important: Because the charging LED indicators are disabled in High Efficiency Mode, you must manage the 4-hour recharge time using your own timer.

- While in High Efficiency Mode, there is no Ethernet connectivity for the charger. There is no monitor and control functionality for SystemOn or any other connected solutions like Crestron/AMX.
- When a Charger transitions to High Efficiency Mode, any microphones currently docked in the charger also transition to High Efficiency Mode (identified by the removing the microphone from the charger and observing that the microphone is powered off).
- After a power cycle of a charger in High Efficiency Mode, the charger visually indicates standard charging and any microphones removed from the charger follow the configured **Initial State from Charger** preference in the APT configuration.
- A microphone docked in a charger that is in High Efficiency Mode, which has not yet reached full charge, supports the legacy battery cycle count reset mechanism (hold mute button for 10 seconds to trigger cycle count reset). The microphone does not support this mechanism if a full charge has been reached.

Note: You should only use the battery cycle count reset after installing a new battery.

USB Charger

The USB Charger (SBC-USB) can connect to an MXW transmitter to provide power during operation.



Battery Statistics on Control Software

The MXW control software is used to manage battery information. Use the Monitor tab to view battery charging status:

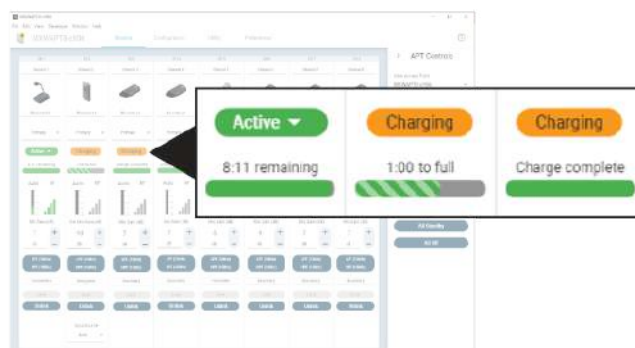

Monitoring Battery Charge Status

In the Charging Station

Displays the remaining time until the microphone battery is fully charged.

During Use

Displays the remaining battery runtime of the microphone.

For battery health statistics, use the Utility tab:

 A screenshot of the MXW control software interface showing the 'Utility' tab. A callout box highlights a table of battery statistics. The table has two columns: 'Battery Capacity' and 'Cycle Count'. The data rows are: 99% capacity with 117 cycles, 95% capacity with 50 cycles, and 94% capacity with 105 cycles.

Battery Capacity	Cycle Count
99%	117
95%	50
94%	105

Battery Statistics

Battery Capacity

The microphone battery's percentage of charge capacity as compared to a new battery.

Cycle Count

Number of charge cycles logged by the battery.

Reset the Microphone Battery Statistics

After installing a new battery, reset the battery health statistics that are stored in the microphone.

1. Place the transmitter with a new battery into a charging slot. You can use any powered MXW charging station.
2. Press and hold the mute button on the microphone until its LED flashes (~10 seconds).

Caution: Securely hold the microphone while pressing the button to avoid damaging the USB ports on the charging station.

Maximizing Battery Life

While the rechargeable Li-Ion batteries for MXW transmitters are designed to last up to 9 hours or more on a charge, variance in battery health and use-case may result in significant differences in battery runtime. Specifically, consistency and overall runtime decrease with the number of charge cycles. Battery health of 80% or less is an indicator that a battery is nearing or at the end of its designated life cycle and should be replaced. Health percentage and number of charge cycles are available from MXW control software > Utility tab.

The MXW system's secondary link slots allow you to prepare alternate microphones to swap in if battery levels get low, to ensure variable battery runtime does not cause audio interruptions. However, the following system adjustments can help get the most runtime out of your batteries.

External LED Control

Having LEDs constantly indicate the microphone state can use a significant amount of battery power. Setting transmitters to External LED Control disables the built-in LED except when activated by external commands via the TCPI (third-party control interface). Maximize battery runtime by disabling the LED completely, or by setting the LED to only indicate when the microphone is not in its usual use state.

LED control is set from MXW control software > Preferences tab.

High Density Mode

High Density (HD) mode reallocates system resources to create additional channels when needed. In applications where latency, back-channel audio monitoring, and filter control aren't major considerations, switching to HD mode can also provide up to an hour of additional battery runtime.

Density mode is set from MXW control software > Utility tab > [desired APT] > Edit.

Use-Case Scenarios

To estimate runtime on older batteries, find your microphone and the conditions that most closely match your setup. Runtime (hours) was calculated using batteries at 80% health.

System Settings		Runtime (hours)				
LED	Density Mode	MXW1	MXW2 (SB902)	MXW2 (SB905)	MXW6	MXW8
External	HD	8	15	30	8	8

System Settings		Runtime (hours)				
LED	Density Mode	MXW1	MXW2 (SB902)	MXW2 (SB905)	MXW6	MXW8
External	SD	7	14	26	7	7
Internal	HD	7	14	29	8	7
Internal	SD	6	12	23	7	6

Tip: If additional runtime is needed, make sure the RF Power is at the lowest setting for the size of the room. RF power is set from MXW control software > Preferences tab.

Battery Replacement

Lithium Ion Batteries experience a linear reduction in capacity. Shure recommends establishing a battery replacement schedule customized to the client requirements and replacing batteries when the capacity is no longer acceptable.

Important: After installing a new battery, reset the battery health statistics that are stored in the microphone following the steps in Reset the Microphone Battery Statistics in the previous section.

MXW1, MXW6, MXW8 Battery Replacement

1. Unscrew and open the battery door on the bottom of the transmitter.
2. Remove battery by gently disconnecting the battery connector from the transmitter.
3. Connect the replacement battery's connector to the transmitter.
4. Replace the battery with the label facing out.
5. Close the door and tighten the screw.
6. Dispose of batteries properly. Check with your local vendor for proper disposal of used batteries.

MXW2 Battery Replacement

MXW2 batteries should be replaced by qualified service personnel only.

Installation

Additional Equipment

Network Cables	Use shielded Cat5e (or higher) Ethernet cables, limiting cable runs to 100 meters maximum between network devices.
Audio Cables	Reference the hardware kit user guide supplied with the MXW Audio Network Interface to assemble audio cables to the connectors.
Gigabit DHCP Router (systems with >1 APT)	For systems with more than one APT, a DHCP router is recommended to connect equipment. Ensure that it meets the following requirements: <ul style="list-style-type: none"> • Gigabit ports

- Provides Class 0 PoE with at least 6.5W (for powering the MXWAPT)
- Quality of Service (QoS) with 4 queues
- Diffserv (DSCP) QoS, with strict priority
- If the router features Energy Efficient Ethernet (or Green Ethernet), ensure it is disabled from the ports dedicated for the MXW system.
- Recommended: A managed switch to provide detailed information about the operation of each network link: port speed, error counters, bandwidth used, etc.

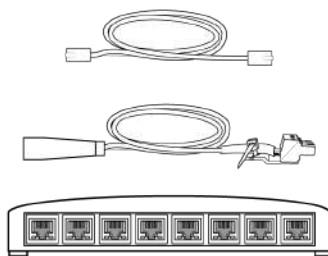

Connecting MXW Components

MXW components are connected using Ethernet cables and a switch. For a small system with a single access point, the MXW Audio Network Interface functions as the switch. For systems with more than one access point, an additional gigabit switch is required for connecting all the components together.

Requirements:

- Use shielded Cat 5e (or higher) Ethernet cables. Limit cable runs to ≤ 100 m between devices.
- Use Gigabit networking equipment between network audio devices (required for systems with >1 access point).
- Ensure MXW components are on the same firmware version.
- Ensure MXW components and the PC are on the same network and set to the same subnet.

Single Group System (1 Access Point)

When the system is limited to a single group (up to eight channels), use the MXW Audio Network Interface four-port switch for connecting MXW components. Connect the computer, access point and up to two chargers to the MXW interface according to the table and diagram:

Audio Network Interface Port	To Component
① Port 1 (PoE)	Access Point Transceiver (APT)
② Port 2	Networked Charging Station (NCS)
③ Port 3	(Optional) Additional NCS
④ Port 4*	Computer

*When Port 4 is set to Uplink mode, Shure Discovery Application support is restricted.

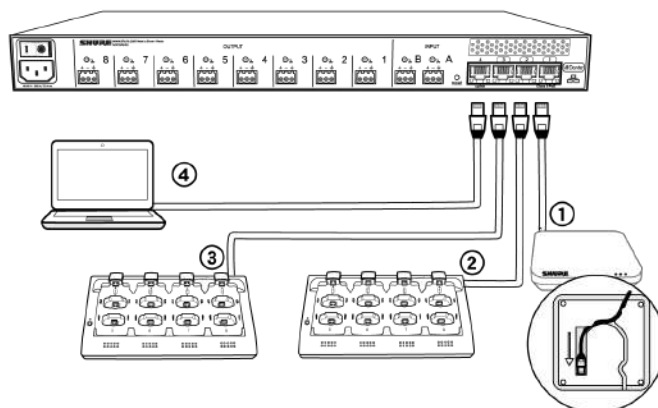

Multiple Group System (>1 Access Point)

When an installation requires more than eight channels, additional MXW components can be connected to expand the system. A gigabit router is required to connect all components to the same network. The following are several topologies for multiple group systems.

Use the Spectrum Scanner to ensure that there is sufficient RF availability for the installation.

Large Single-Room Installation

1. Power on the DHCP-enabled router.
2. Connect the router to a computer.
3. Connect each APT to a Power over Ethernet (PoE)-enabled port on the router. Use a PoE inserter if the router does not provide it.
4. Connect each ANI to the router.
5. Connect chargers to the ANI ports, or to the router.

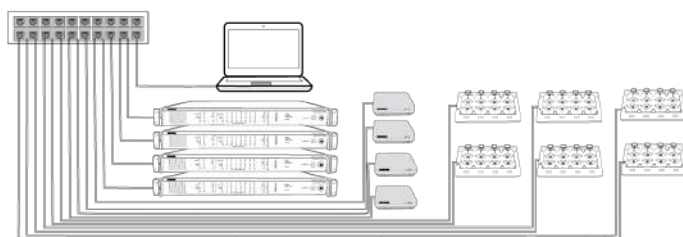

Local System Star Setup

To minimize cabling, MXW components can use the Audio Network Interface as a local switch that connects to a shared network.

1. Power on the DHCP-enabled router.
2. Connect the router to a computer.
3. Connect the router to Port 2, 3, or 4 on the Audio Network Interface
4. Connect the Access Point Transceiver to the Port 1 of the Audio Network Interface.
5. Connect the Network Charging Station(s) to an open port(s) on the Audio Network Interface.
6. Repeat steps 2 - 4 for additional equipment.

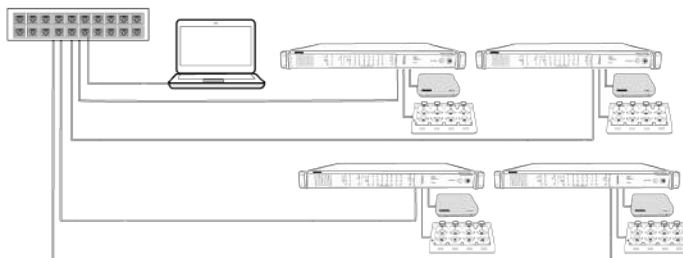

Rack Installation

Rackmount the device using the screws and washers supplied in the Hardware Kit. Follow these general best practices when installing equipment in a rack:

- Ambient temperature of the rack should not exceed specified operating temperature range of the device.
- Keep fan inlet and side air vents clear from obstructions and provide adequate space for airflow within the rack.
- When possible, provide 1 RU of empty space between each device.

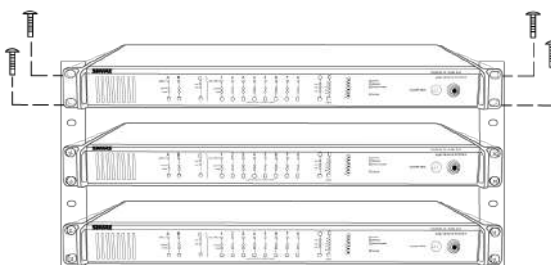

Securing the Charging Station

This kit provides washers and screws for securing a charging tray to a table or other surface. Use two kits for the NCS8. Please refer to the NCS mounting template for screw hole placement.

Important: The top of the screw must extend **exactly** $\frac{9}{64}$ (0.149) inches (3.78 mm) above the surface (about 4½ threads).

- Use the screws that best fit the thickness of the table.
- Use a lock washer and flat washer for each screw.
- If necessary, counterbore the screw head or add additional flat washers.

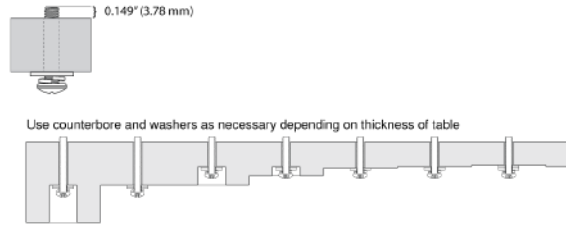

Required Thread Exposure

Use counterbore and washers as necessary depending on thickness of table

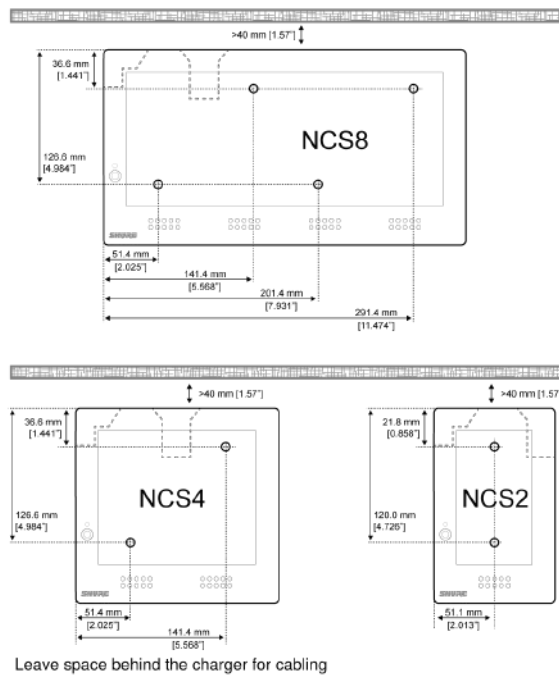

NCS Mounting Template

Two-Channel Charger Wall Mount

The two-channel charger includes a wall-mount to provide quick microphone access and storage in a classroom or conference room.

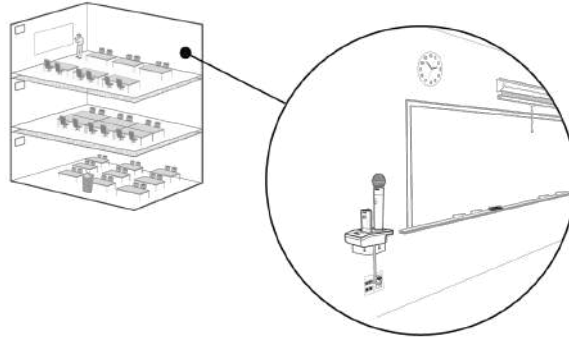

NCS2 Secures to a Classroom Wall

Tip: Paint the mount to match the wall for a less obtrusive installation.

Installation

1. Determine the orientation and placement of the mount.

Placement	Orientation
<p>Wall</p>	
<p>Drawer or tray</p>	

2. Leave room around the mount for cabling to the charging station.

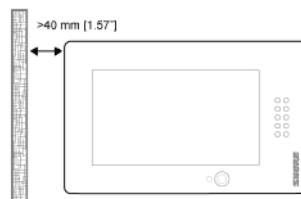

3. Attach the mount to the wall. Use one set of screw holes depending on the orientation of the mount.

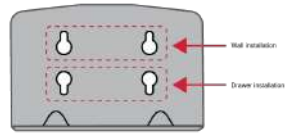

Mount Screw Holes

4. Align the charger on the mount and secure with the screws.

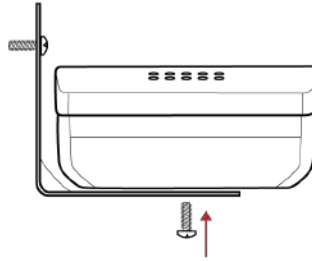

Tip: Improve cable management using the cable tie holes on the mount.

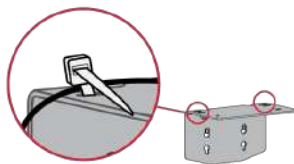

NCS2 Mount Dimensions

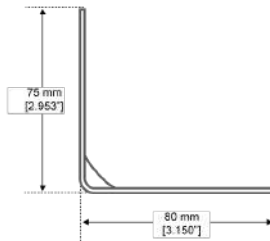
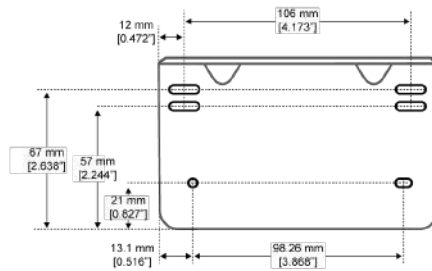
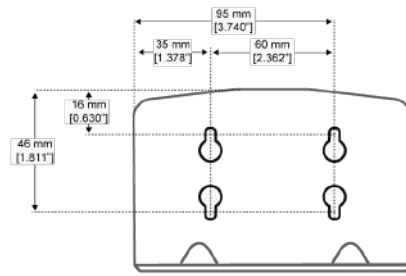

Side View

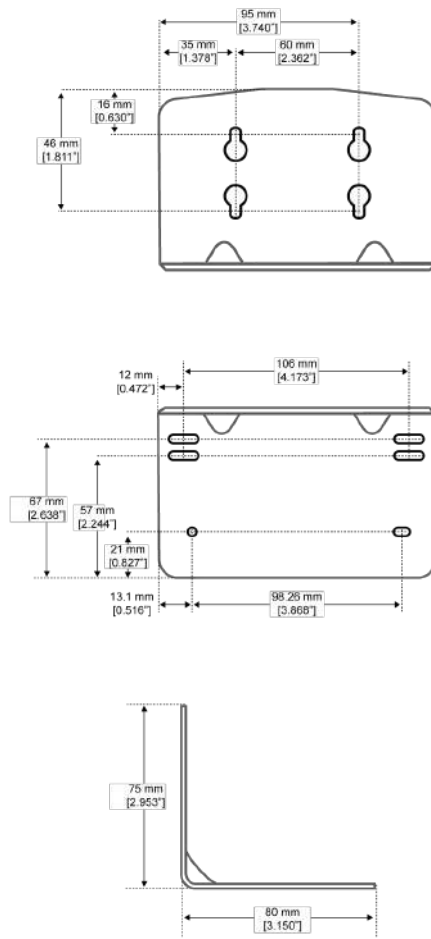

Top View

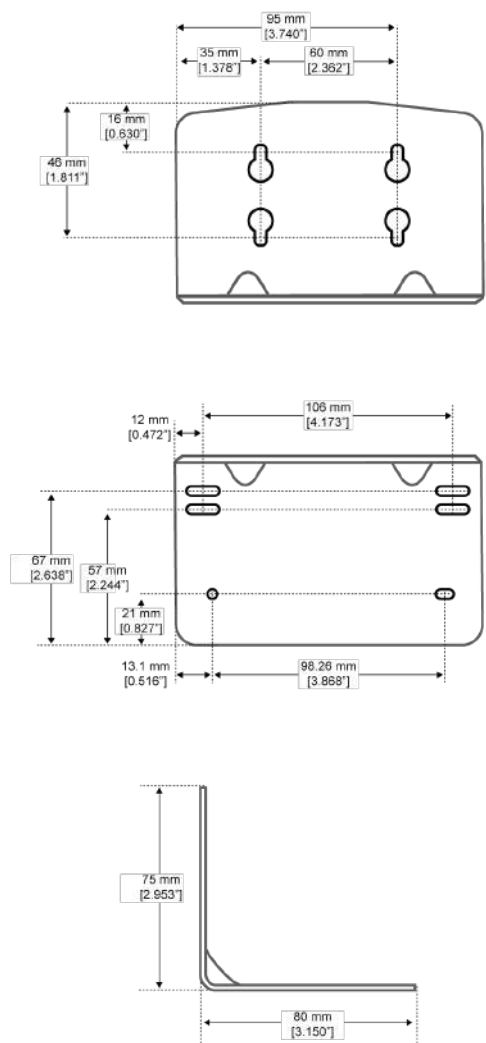

Overall Dimensions

Mount the Access Point Transceiver

The directional antennas of the APT send and receive the RF signal in a cardioid pattern with the greatest sensitivity toward the face of the device. Always aim this side toward the microphone coverage area.

Select a Location

The access point is typically mounted to a ceiling or wall near the microphone coverage area. For best results, perform a Spectrum Scan at potential locations to find the optimal placement (see Wireless Management section for more details).

Use the following best-practices when selecting a location for the device:

- Direct the face of the access point toward the intended coverage area.
- Position the access point so there is nothing obstructing a line of sight to the microphones.
- Keep device away from large metal objects.
- Keep at least eight feet between access points.
- Mount with its reset button accessible, as it may be useful for troubleshooting.

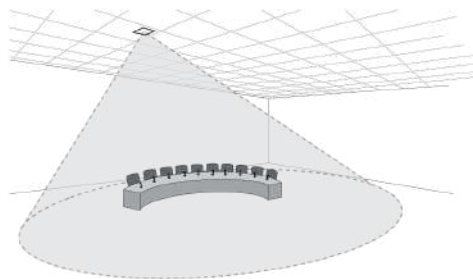

Important: Always perform a "walk around" test to verify coverage before using a wireless system during a speech or performance. Experiment with antenna placement to find the optimum location. If necessary, mark "trouble spots" and ask presenters or performers to avoid those areas.

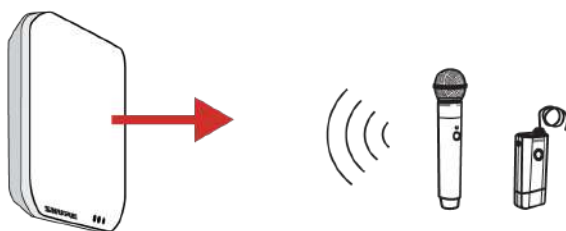

Mount with this side facing the microphones

Cardioid RF Pattern

Securing to a Wall or Ceiling

Required Equipment

- Two #8 screws at appropriate length*

*Screw Length = Surface thickness + thread engagement (4.75 mm max.) + thickness of flat washer + the thickness of the split lock washer

General Installation Steps

1. Use the mounting plate as a template and mark the location for the holes.
2. Drill the holes into the mounting surface.
3. Secure mounting plate to the surface.

CAUTION: Do not over-tighten screws, as this could cause permanent damage to the charging station

4. Connect of the Ethernet cable to the MXWAPT using the cable route path.
5. Position the MXWAPT over the keyway slots of the mounting plate and slide it down into the locked position.

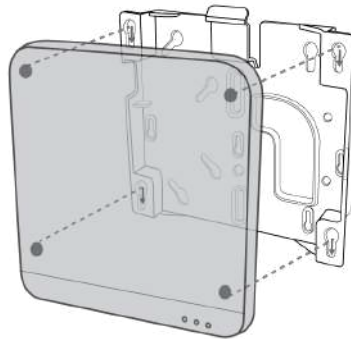
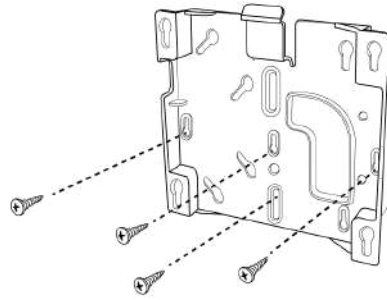

External Cover for Painting

The Access Point is supplied with an external cover that can be painted to match the decor of the installation. After it has been painted and dried, it snaps onto the front plate of the device.

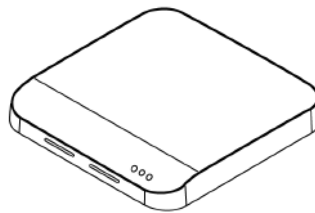

Power the Hardware

① Audio Network Interface (ANI)

Connect the IEC power cable from the back panel to an AC power source. Turn on the power switch.

② Access Point Transceiver (APT)

Connect a shielded Cat5e cable from the MXWAPT to network Port 1 of the MXWANI. If using an external gigabit switch, ensure Class 0 PoE provides at least 6.5W of power to the APT. There is no power switch.

③ Networked Charging Station (NCS)

Connect the PS60 external power supply from the charger to an AC power source. Turn on the power switch.

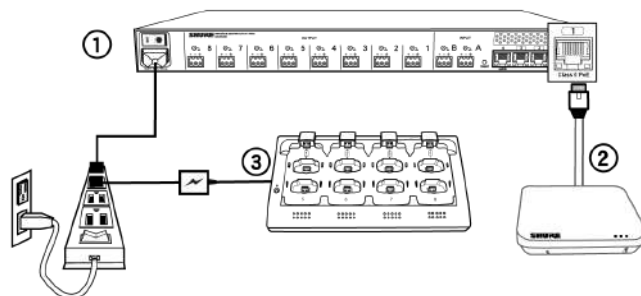

Fully Charge the Transmitters

Whenever possible, charge to full the MXW transmitters before an event. Transmitters can be charged in **any** networked charging station, even if it is associated to another Group or on a separate network.

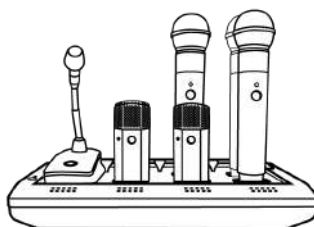

Battery Charge Times

Approximate Charge Times

Charger Type	Time to Full Charge* (hr:min)
Networked Charging Station (NCS)	MXW1, MXW6, MXW8, MXW2 (with SB902): 2:00
	MXW2 (with SB905): 5:00
Networked Charging Station (NCS) in High Efficiency Mode (Link LED illuminated blue)	MXW1, MXW6, MXW8, MXW2 (with SB902): 4:00
	MXW2 (with SB905): 5:30
USB Charger	MXW1, MXW6, MXW8, MXW2 (with SB902): Powered On = 3:30 Powered Off = 2:30
	MXW2 (with SB905) Powered On = 9:30 Powered Off = 7:30

*Calculated with a new battery. Runtimes vary depending on battery health.

Open the MXW Control Software

Download and install the MXW control software to control the system from any computer on the MXW network.

There are two different control interfaces for MXW devices:

- *MXW system*: For comprehensive control of key setup, monitoring and management functions for the MXW system. Accessed from the Access Point Transceiver (APT).
- *Audio Inputs and Outputs*: For sending audio channels on and off the Dante network. Accessed from the Audio Network Interface (ANI).

1. Get the Shure Microflex Wireless application

Download and install the latest version from www.shure.com/software.

2. Connect the computer to the MXW network

All networked devices must be connected to the same network (set to the same subnet).

3. Turn off WiFi (recommended)

For best results, turn off the PC's WiFi to force the wired network interface.

4. Open the Shure Microflex Wireless application

Open the application to view connected MXW devices, such as the APT. You can use the Identify button to flash a device's LEDs for easy identification.

5. Initialize new hardware

When a device is powered on for the first time, or after a factory reset, the control software identifies it as "New," and prompts you to initialize it before use. Click "Initialize the devices" and create a passphrase using 8-64 ASCII or Unicode characters.

Operating System Requirements

To operate the control software, the computer must meet the following minimum requirements:

Operating System

Windows 10 (Professional or Enterprise), 64-bit edition

MacOS 10.15 "Catalina"

MacOS 10.14 "Mojave"

Hardware

8 GB of available RAM

1 GB of available disk space

i5 Dual-core processor or later

System Set Up

Group Devices to Form Audio Channels

Use the group configuration to form the audio channel between the microphone, the access point (APT), charger and audio output device. The audio channel establishes the audio routing, RF coordination, and data control for a set of devices. Groups are comprised of networked devices (set to the same subnet). A component can belong to one group at a time.

Start with the APT and select the corresponding devices:

- Chargers: for linking microphones
- Audio outputs: for routing audio to analog outputs

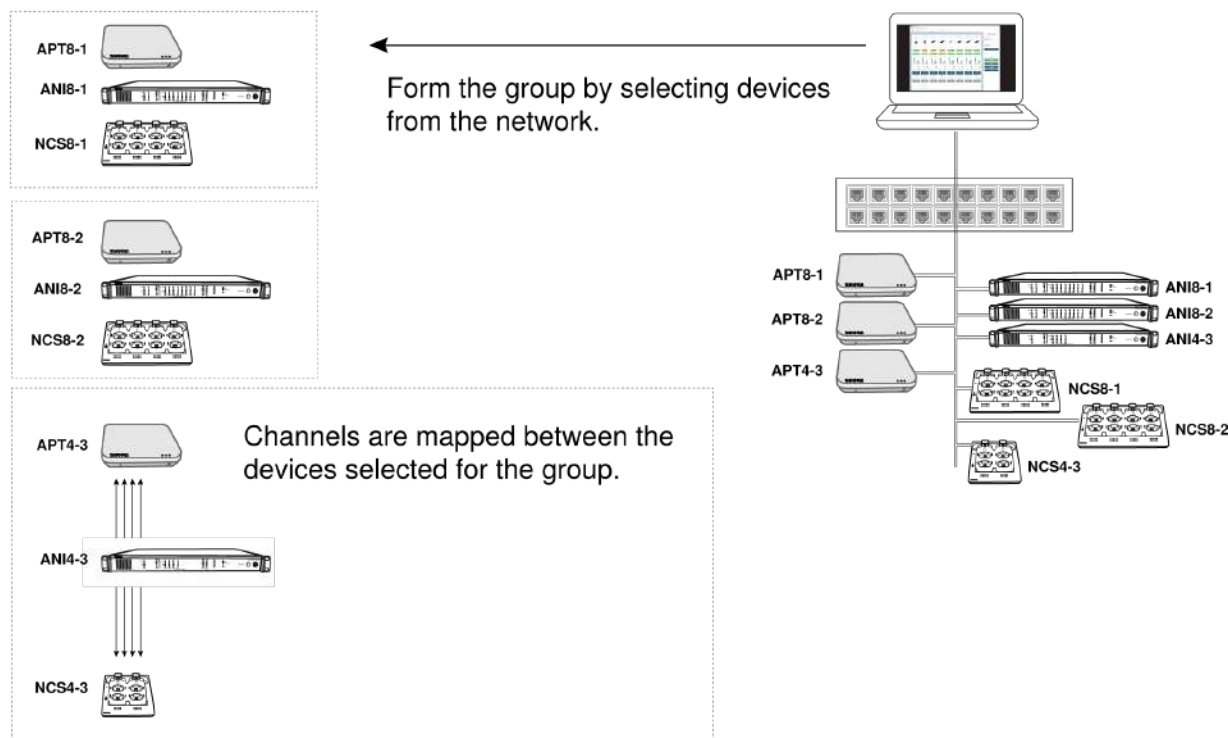

Group Components from the Network

Once the group formed, microphones can be linked to channels using the charging station.

Select Devices for the Group

Use the MXW control software to view devices on the network and assign them to a group.

Tip: Use the ID button to identify a device. This flashes the component LEDs for easy identification.

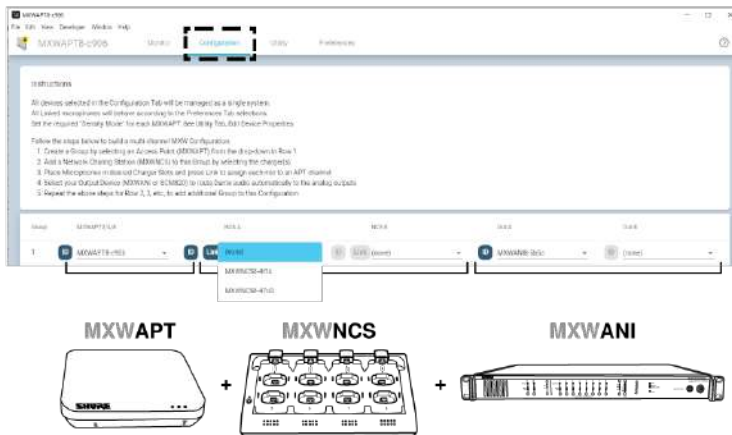

<p>1. Go to the Configuration Tab</p>	<p>Assign the devices to groups from the Configuration tab of the MXW control software.</p>
<p>2. Select the Access Point Transceiver (APT) for Group 1</p>	<p>Select an APT to determine group channel count (2, 4 or 8). Group 1 automatically uses the APT opened from the Devices list. Other networked (and open) APTs are available for additional groups.</p>
<p>3. Select the Network Charging Station(s)</p>	<p>Select one or two Network Charging Station (NCS) to the access point. An additional charger can be added to the group:</p> <ul style="list-style-type: none"> • When using multiple smaller chargers to fill the channel count of the group. For example, two 4-channel chargers for an 8-channel group. • When using gooseneck microphones. Gooseneck mics cover the front and back slots of a charger, halving the number of slots available. For example, two eight-channel chargers are required to fill an eight-channel access point with gooseneck microphones.
<p>4. Select the Audio Output Device(s)</p>	<p>Select one or two audio output devices (MXWANI or SCM820) to automatically route the digital audio channels from the access point. Select from the following devices:</p> <ul style="list-style-type: none"> • Audio Network Interface (MXWANI) four- or eight-channel variation. • Shure SCM820 IntelliMix® Mixer. Dante-enabled SCM820s can be selected as the audio output for the Group. This automatically routes the SCM820's aux input to the microphones for personal monitoring (SCM820 aux left channel to MXW channels 1 - 4; aux right channel to MXW channels 5 - 8).

Note: Component group and microphone link data are persistently stored in each device. If the MXW system is shut off and then restarted without a computer, the devices will remain associated to the access point.

Device Availability

When setting up a group or managing devices, it is important to understand the difference between open and associated devices.

<p>Open Device</p>	<p>A device that is not associated to a group is considered 'open.' Open devices are available for association by selecting the drop-down window in a Group row. The device will show Open in the Group column of the Utility page.</p>
<p>Associated Device</p>	<p>A device is considered 'associated' once it has been selected in a group row. Each device can only belong to one group at a time (and therefore one Configuration). Once a device has been associated to a group, it is managed on the Configuration tab can be viewed in detail on the Utility tab. The device will show its group number in the Group column of the Utility page.</p>

A device can be unassociated by selecting 'none' in the group row drop-down to clear it from the group. The device is then open and available for association to another group.

Tip: Performing a factory reset will default the device to open.

Associated devices show group number

Available devices show Open

Group	Device Model	Device Name	IP Address (static)	IP Address (network audio)
1	MXWAPT6	MXWAPT6-c906	192.168.1.103	192.168.1.101
2	MXWAPT6	MXWAPT6-4163	192.168.1.107	192.168.1.105
1	MXWANC38	MXWANC38-RTL	192.168.1.102	-
1	MXWANC38	MXWANC38-4729	192.168.1.104	-
Open	MXWANC38	MXWANC38-7543	192.168.1.111	-
Open	MXWANC38	MXWANC38-e594	192.168.1.100	-
1	MXWANB	MXWANB-900C	192.168.1.108	-
2	MXWANB	MXWANB-5cc0	192.168.1.109	-

Device Availability

Automatic Group Setup

An MXW Group can be associated without use of the control software when a network is comprised of only one Access Point Transceiver (APT), one Networked Charging Station (NCS) and one Audio Network Interface (ANI). For best results, perform a factory default on the devices to clear any previous Group associations.

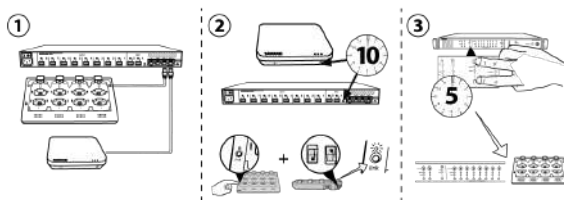

1. Connect one APT, one NCS and one ANI to the network. The network must only contain one of each device.
2. Perform a factory reset on the devices (see the Factory Default section).
3. On the front panel of the ANI, press both input level selection buttons at the same time and hold for five seconds. The Channel Select LEDs will illuminate green and the audio meter will flash to indicate that the association is successful.

Channel Routing between Devices

Channels are routed when charging stations and output devices are selected to fill the APT group (2-, 4-, or 8-channels). Once the devices are selected for the group, the channels are mapped between the charging slots, audio outputs and the wireless receiver.

Group selections are made from the Configuration tab of the control interface.

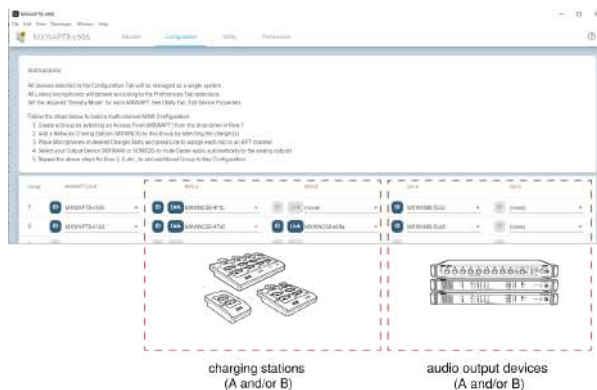

Group Selections Determine Routing

Each group has two selections available for charging stations and audio output devices. The selections determine the channel routing in the group.

Charging Station Examples

8-Channel Group



Boundary, Handheld or Bodypack Microphones

Only one 8-channel charger is needed to fill the group with these types of microphones.

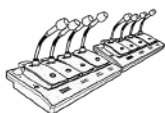

Gooseneck Microphones

This setup is used to fill an 8-channel group with gooseneck microphones. Channels are rerouted when an additional charger is added to the group. (The gooseneck base is larger and covers two charger slots.)



NCS A		NCS B			
1	2	5	6	7	8
x	x	x	x	x	x

Mixture of Gooseneck and Boundary Microphones

When 4-channel and 8-channel chargers are selected, group channels five through eight are automatically routed to the back row of the 8-channel charger.

4-Channel Group

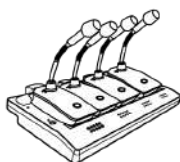

NCS A				NCS B
1	2	3	4	
x	x	x	x	X

Gooseneck Microphones

This setup is used to fill a 4-channel group with gooseneck microphones.

2-Channel Group



NCS A		NCS B
1	2	
		X

2-Channel Charger

The 2-channel charger supports boundary, handheld, and bodypack microphones.

Audio Output Examples

8-Channel Group

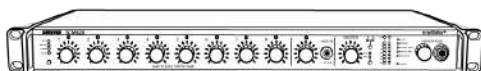

Out A								Out B
1	2	3	4	5	6	7	8	
								X

8-Channel SCM820 Digital Automatic Mixer

Channels are routed to the eight outputs of the mixer.



Two 4-Channel Audio Network Interfaces

Channels are routed across both interfaces to fill the group.

4-Channel Group

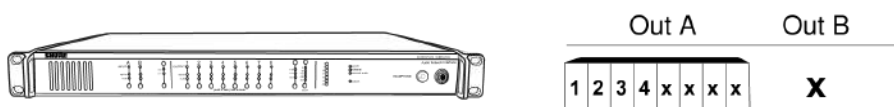

8-Channel Audio Network Interface

Channels are routed to the first four outputs of the interface.

Link Microphones to Group Channels

Use the Networked Charging Station (NCS) to Link microphones to Access Point channels. Slots in the charger are mapped to the APT according to the Group setup from the Configuration tab. Once the Link procedure is complete, audio will route to the corresponding channel in the Group.

Linking will map any microphone placed in the charging station to the APT channels. This replaces any prior microphone Link for that channel. If a slot is empty during the Link procedure, there will be no impact on that channel.

<p>1. Arrange microphones in the charger.</p>	<p>Microphones are Linked to access point channels according to the arrangement in the charger.</p> <p>Note: 2-channel chargers do not support gooseneck microphones.</p>  <p>Connecting the Microphone to the Charger Slot</p>
--	--

<p>2. Link the microphones to channels.</p>	<p>Use the control software or the charging station to Link the microphones to APT channels. If desired, this feature can be disabled on the charging station so that Linking can only be performed from the control software:</p> <ul style="list-style-type: none"> • Control Software: From the Configuration page, press the Link button for each charger in the Group. • Charging Station: Press and hold the Link button for 6 seconds. The LEDs flash during the process and turn solid green once the Link is successful. <p><i>NOTE: Pressing the Link button on the NCS will link microphones to the Primary slot on the associated APT. Use the control software to link microphones to secondary slots.</i></p>
<p>3. Remove Mics and Test the Audio</p>	<p>Test the audio for each microphone and adjust mic gain if necessary from the Monitor tab of the control software. The gain should be set at a level where the audio is registering (green/yellow) on the signal indicator but not clipping (red).</p>  <p style="text-align: center;">Monitor Tab</p>

Preparing a Backup Microphone

Prepare an alternate microphone for each channel for more reliable and flexible events. Two MXW microphone transmitters can be linked to the same channel, providing the option of either microphone for use.

Link a mic to the secondary slot to anticipate needs that may arise during events:

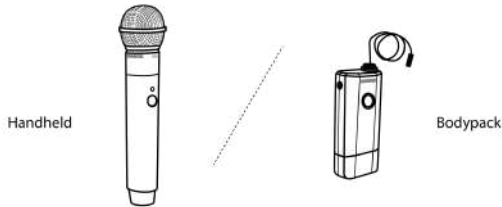

Microphone Preference

Give presenters a choice between two different microphone types, such as handheld or bodypack microphones.



Charged Backup Microphones

Prepare for long events by linking fully-charged microphones as backups

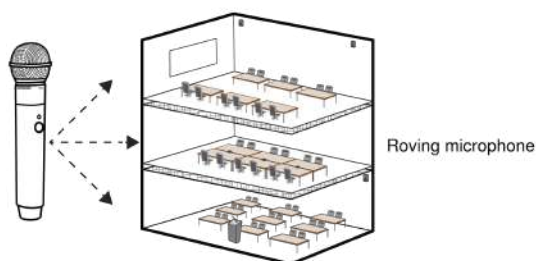

Shared Resources

Easily add a temporary microphone without unlinking the most commonly used microphones.

One Active Mic per Channel

Only one microphone will operate on the channel at a time, blocking the second microphone from interfering with the RF and audio performance. The backup microphone briefly flashes the LED to indicate the channel is occupied, and automatically turns off to conserve the battery. To use the second microphone, simply turn off the first microphone.



Two Microphones Ready for the Audio Channel

The system allows one live microphone per channel.

Procedure

Link a single microphone:

1. Place the secondary microphone into the same charging slot that was used for the primary microphone.

2. Open the desired MXWAPT (double-click from the Devices view) and go to the Monitor tab.
3. Select Secondary in that channel's link slot.
4. Select the Link button on the channel strip to link that microphone. The charger LEDs will flash when the procedure is complete.

Link multiple microphones:

1. Place the secondary microphones into the same charging slots that were used for the primary microphones.
2. Open the desired MXWAPT (double-click from the Devices view) and go to the Configuration tab.
3. Find the desired charger in the group row. Use the ID button to make sure the right charger is selected.
4. Select the Link button in the group row.
5. In the popup window, select All Secondary for the link slot.

Exchanging or Removing a Component

Exchanging a Transmitter

The same Link procedure is done to exchange a transmitter in a group. Place the new transmitter in the charger slot that corresponds to the desired channel and perform the Link procedure. This will map the new transmitter to that channel, and remove any Link from the old transmitter.

If an NCS channel slot is empty during the Link procedure, the channel will remain unaffected.

Important: Use caution when replacing microphones, as the Link procedure applies for all microphones in the charger. The Link will immediately override any existing microphone's audio and RF connection to the system.

Remove a Device from a Group

To remove a device from a group, open the MXW Control Software and go to the Configuration tab. In the group row, select the device drop-down window that contains the desired device. Select 'none' to clear the device association.

Note: A factory reset will also remove the any association or Link status.

Link a Microphone Over the Network

To improve device management from a central help desk or technician station, a microphone can be linked to any group on the network using a remote charging station. Using a control system, send the command strings* to replace a microphone for a specific channel. Group settings are not affected by this procedure.

1. Connect a spare charger to the network.
2. Place the microphone in a charging slot.
3. Modify the following command string according to the setup :

SET PRI x REMOTE_LINK y {zzz.zzz.zzz.zzz}

- ① PRI (primary) or SEC (secondary) channel link
- ② Charging slot number used for new microphone
- ③ Channel targeted for this procedure
- ④ IP address of the APT (device that stores the group settings)

4. Send the command to the charger.
5. Verify the command response:

*A comprehensive list of MXW command strings are available on the Shure website: www.shure.com, search "command strings".

Large Installations

Shure SystemOn Software For Managing Large Systems

Shure SystemOn Audio Asset Management Software provides a central platform for managing mission critical, large-scale deployments of Shure audio hardware across corporate and higher education networks. SystemOn goes beyond the functionality of the MXW control software, working across subnets and APT groups to provide IT administrators and AV technicians the ability to proactively monitor and control Shure hardware devices remotely using a laptop, smartphone or tablet.

Visit <http://www.shure.com/SystemOn> for more information.

High Density Mode

High Density (HD) mode creates additional channels for large meetings and crowded RF environments. HD mode doubles the number of channels available in standard mode, with minor changes to some system features. You can set the density mode for each APT individually to get the right blend of channel count and audio performance.

Density Mode Comparison

Feature	Standard Density	High Density
Channels available*	Up to 40	Up to 80
Audio latency	18 ms	28 ms
Microphone battery life	Up to 7 hours	Up to 8 hours
EQ filters	Optional	Always on
Back-channel audio (headphone output on the microphone)	Available	Unavailable

*For Americas region. See Maximum Channel Count table for availability worldwide.

Setting the Density Mode

Set the mode for each APT from the device properties:

1. Go to MXW control software > Utility tab > [Find the desired APT] > Edit
2. Choose a density mode:
 - Standard (default)
 - High
3. Select Add updates to exit the device properties.
4. Select Apply All from the Utility page to push to your devices.

Configurations: Managing Multiple Groups

Configurations allow multiple Groups to share the same preferences, global controls and log-ons. When an additional Group is added to the Configuration tab, the new components will take on the preferences and global actions of that Configuration. For example, all microphones Linked to Groups in that Configuration will mute when the global Mute All button is pressed.

For specialized applications, such as multiple room installation, separate Configurations can be created to independently control component Groups.

Primary Access Point

When using a Configuration to manage multiple groups, the system dynamically assigns a Primary Access Point. All Access Points in that Configuration use the Primary Access Point as an entry point to the same control interface. This enables the coordination of preferences and the synchronization of system operations across multiple devices.

When the Primary Access Point is unplugged (or PoE is powered off), a new APT is quickly re-established to maintain control of the Configuration. If the Primary Access Point is manually removed by deselecting the APT from the Group on the Configuration tab, there will be a pop-up warning "Are You Sure?". If Yes is selected, the browser will close and a new Primary Access Point is automatically selected.

Creating Separate Configurations

For installations that spread across multiple rooms, a different set of preferences and global controls may be required for a given space. Do this by setting up a separate Configuration:

1. Open the Shure Microflex Wireless control software.
2. Double-click the Access Point that will be used for the new Configuration. The APT must be open (not already assigned to a group) in order to start a new configuration.
3. Go to the Configuration tab.
4. Select that Access Point from the drop down list in Row 1. Use the ID button to ensure the correct Access Point is selected.
5. Select the charging station(s) and output device(s) to complete the Group.
6. Repeat 4-5 for up to 10 Groups in the Configuration.
7. Customize the Configuration as desired from the Preferences tab.

Note: Ensure that all APTs are connected to the same network and set to the same subnet, even if they are assigned to a separate Configuration. This ensures the best system performance, highest channel count, and tightest digital audio clocking for the installation.

Wireless Management

Overview of Channel Coordination

The MXW system operates using time division multiple access (TDMA) to carry MXW channels (audio and control data) within defined RF spectrum. Channels are automatically assigned to the time-slots by the access point, which manages the spectrum and seamlessly changes slots if interference is detected. The MXW system makes this adjustment automatically and without audio artifacts.

Maximum Channel Count

The following table shows the maximum MXW channel count available in each region. Use the spectrum scanner to view how many of these channels are available to you at your installation.

Band	Region	Density Mode	
		Standard (SD)	High (HD)
Z10	USA, Canada, Mexico	40	80
Z11	Europe, Asia, Middle-East	80	160
Z12	Japan	48	96

Band	Region	Density Mode	
		Standard (SD)	High (HD)
Z14	Brazil	40	80
Z15	Taiwan	64	128

Scanning Available RF Spectrum

The MXW Wireless components operate in unlicensed spectrum that is shared with other wireless devices operating in the same area, such as cordless phones, walkie-talkies and intercoms. The MXW control software features a scanning tool that surveys the RF spectrum for these devices. It calculates the percentage of Radio Frequency Interference (RFI) in the area and provides recommended channel count ranges. Estimated channel counts are displayed for both standard and high channel count modes.

During a scan, any microphones linked to that Access Point are turned off in order to survey the area for interference from other devices. The scan calculates the current spectrum and the minimum spectrum available, which provides the greatest level of safety in determining channel count availability in a space. The Minimum Spectrum Available data will persist until a new scan is performed or the data is cleared.

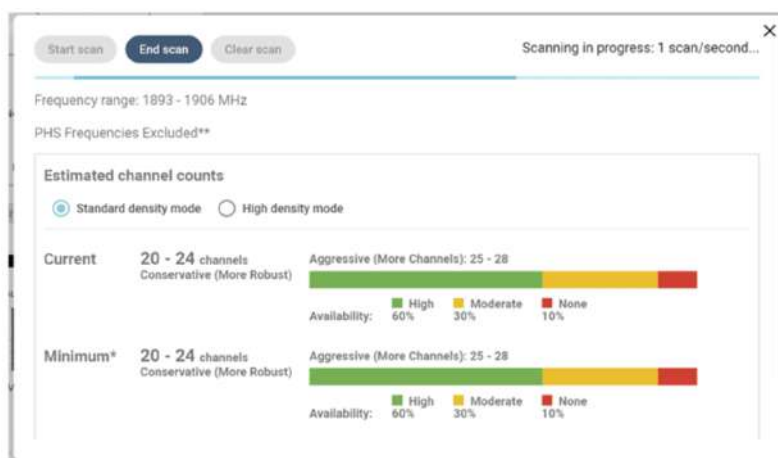

Spectrum Meter During a Scan

Displays the percentage of available spectrum

Radio Frequency Interference (RFI)

The scanner analyzes the spectrum and divides the data into three categories:

Availability: High (Green)

Clean RF available for MXW system.

Availability: Moderate (Yellow)

Some moderate interference is detected, still usable by the MXW system.

Availability: None (Red)

Busy RF occupied by other devices.

Estimated Mic Channel Count

The scanner provides two estimate levels for MXW microphones:

Conservative (More Robust)

Reference this channel estimate for maximum **channel stability**. It includes extra usable spectrum for optimal interference avoidance, allowing multiple microphones to find available frequencies simultaneously.

Aggressive (More Channels).

Reference this estimate to get the **most channels** on air. It reserves only the minimum required extra spectrum for interference avoidance. Be sure to occasionally monitor the spectrum and make channel adjustments if the RFI increases.

Performing a Scan

Follow these steps to perform RF scan.

Tip: Perform the scan during typical hours of operation to best capture the typical interference in an environment.

1. Ensure all typically used devices are turned on, including any MXW equipment already in use.
2. Place the new MXW Access Point near the location it will be mounted.
3. Ensure the APT is on the same network and set to the same subnet as the other MXW equipment.
4. Open MXW control software to the Monitor tab. Make sure the new Access Point is selected from the drop down on the top left corner of the Monitor tab.
5. Select the Spectrum Scanner to open the window.
6. Select the Start Scan button at the top of the window. If any microphones are Linked to that Access Point, they will be turned off during the scan.
7. For best results, allow the scan to run for up to 24 hours to get a full snapshot of the spectrum throughout the day. Press End Scan to end the scan mode.

PHS Detection

The APT scanner may discover interference from devices that have priority in the JDECT (Z12) spectrum. When personal handy-phone systems (PHS) are detected, the MXW system will automatically reduce operation to 67% of typical spectrum use.

The APT automatically scans for PHS upon power up and when the Spectrum Scanner is manually launched from the Monitor tab. The Spectrum Scanner includes the PHS limits when calculating the maximum channel estimates to provide the safest estimates.

Excluding PHS Bands

To operate in the JDECT spectrum without worrying about PHS interruption, set the MXW access point (APT) to exclude PHS channels. This reduces the number of MXW channels available, but ensures that microphones will never be overridden in the event of PHS detection.

1. Go to MXW control software > Utility tab.
2. Select the APT and open the device properties.
3. Select PHS Exclusion.
4. Select Add Updates to close the window.
5. Start the update by selecting Apply All from the Utility page.

Identifying PHS Detection Errors

When operating in the JDECT band without PHS Exclusion, transmissions from adjacent MXW systems can trigger a PHS detection.

JDECT regulations require an automatic cutoff in devices transmitting RF signals on the channels used by the PHS mobile phone network. When an MXW APT detects a signal above the -82dBm RSSI threshold, it stops transmitting and a warning displays on the Monitor tab of the MXW web application.

Some applications may be outside of the range of the PHS mobile network and can benefit from use of the additional channels. To overcome PHS detection from a nearby MXW system, run a spectrum scan to find new, non-restricted frequencies.

Resolving PHS Detection Errors

Before you begin, confirm all APTs are online and connected to the same subnet.

Next, the device Preferences in the control software and reduce wireless RF overlap between APTs by lowering the RF Power to Low. You can change power settings back after resolving the error.

Caution: Audio is temporarily interrupted during spectrum scan. Do not initiate a scan during a live meeting.

Running Spectrum Scans

1. Dock all microphones in chargers to decrease MXW affect on the RF spectrum.
2. Select each APT in the control software and go to the Monitor tab.
3. Start a scan on all APTs and let them run at the same time for at least 15 seconds. This analyzes the spectrum and selects the best channel to operate on.
4. Stop the scan, and check for detections. If you do not show any PHS error, the system is ready to go.
5. If PHS error persists, repeat the scan up to 3 times.
6. If PHS detection persists through 3 or more spectrum scans, the signal is most likely coming from the PHS network. Switch your systems to PHS Exclusion mode to operate reliably on fewer channels.

Tip: Resolved detection notifications should not reoccur until a new spectrum scan is initiated, either manually or by rebooting/power cycling the system.

Setting RF Power

The RF radius of a configuration can be limited to allow another MXW system to re-use the frequency time-slots. It is best practice to use the lowest setting that supports the installation. Perform a walk-around test with the transmitters to ensure that the coverage setting is sufficient.

The RF Power is set from the Preferences tab of the control software. The setting applies to each access point in the Configuration. Reference the following table for setting the RF Power.

RF Power Levels

Setting	Transmitter Power (mW)	Coverage Distance from APT	Typical Application
Max	80	150 ft	Ballroom and auditorium spaces
High	16	100 ft	Large meeting spaces and lecture halls
Medium (default)	3	50 ft	Conference, training and multipurpose rooms
Low	1	25 ft	Small video-conference rooms and boardrooms

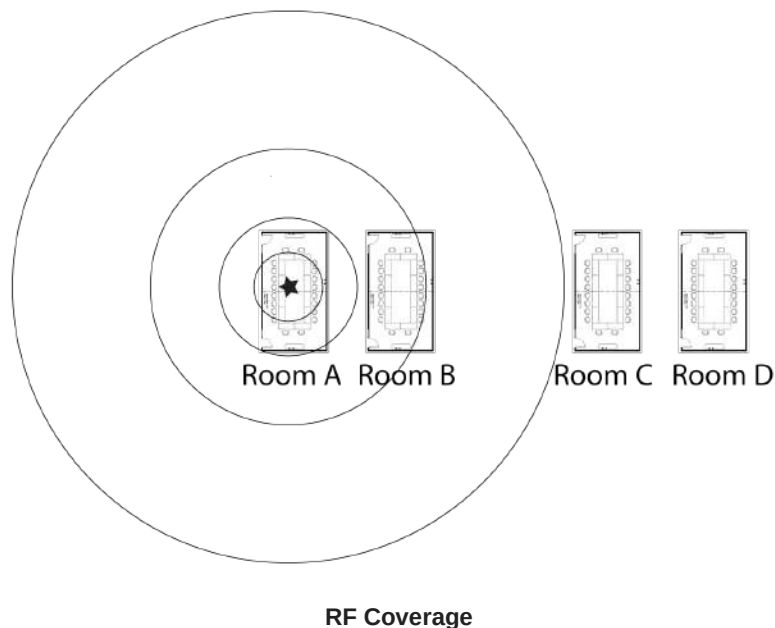

Optimal Placement of the Access Point

Place the Access Point in the center of the installation for best coverage

Using Multiple 2- or 4-Channel Access Points

The MXW access point uses two sets of antennas to cover the operating spectrum. Each antenna set covers half of the timeslots used for MXW channels. Eight-channel units use both antenna sets simultaneously; two- and four-channel units use one set at a time, operating on half of the available timeslots. The full spectrum can be covered they are configured to alternating antenna sets.

When an installation uses multiple two- or four-channel access points (APT2 or APT4), configure the access point settings to maximize channel count. This is particularly important for APTs that are mounted in the same or neighboring rooms.

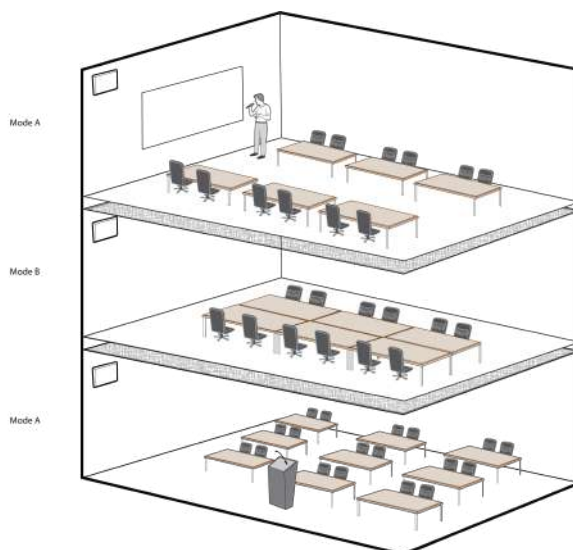

Alternate Antenna Modes to use the Full Spectrum

Requirements

The MXW system must be operating on a minimum firmware version of 8.0.3.

Set Up

1. Open the desired MXWAPT by double-clicking from the Devices view.
2. Go to the Utility page.
3. Open the Device Properties window for the two- or four-channel access point (MXWAPT2 or MXWAPT4).

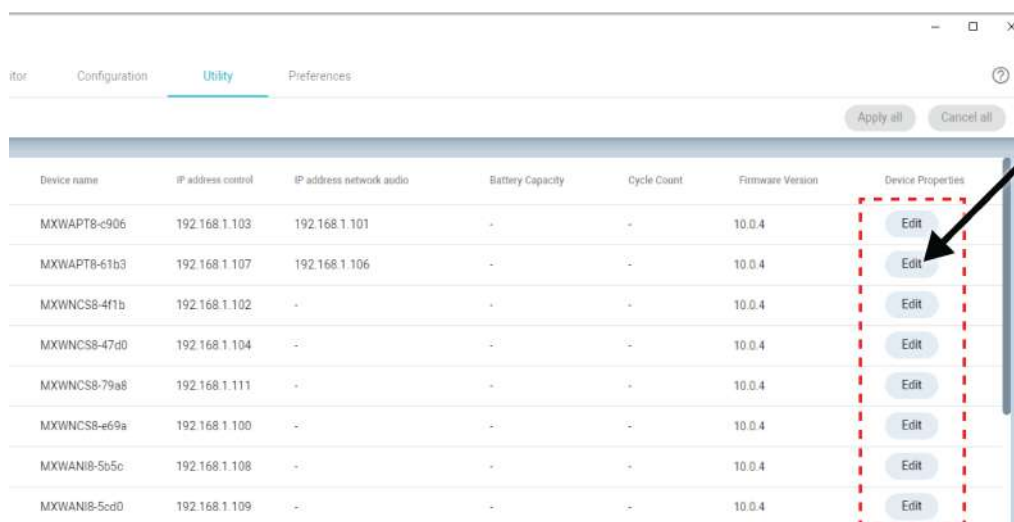

Device name	IP address control	IP address network audio	Battery Capacity	Cycle Count	Firmware Version	Device Properties
MXWAPT8-c906	192.168.1.103	192.168.1.101	-	-	10.0.4	Edit
MXWAPT8-61b3	192.168.1.107	192.168.1.106	-	-	10.0.4	Edit
MXWNCS8-4f1b	192.168.1.102	-	-	-	10.0.4	Edit
MXWNCS8-47d0	192.168.1.104	-	-	-	10.0.4	Edit
MXWNCS8-79a8	192.168.1.111	-	-	-	10.0.4	Edit
MXWNCS8-e69a	192.168.1.100	-	-	-	10.0.4	Edit
MXWAN18-5b5c	192.168.1.108	-	-	-	10.0.4	Edit
MXWAN18-5cd0	192.168.1.109	-	-	-	10.0.4	Edit

4. Note that the APT is set to Mode A by default (Device View > RF Mode Settings > RF Coordination Mode). Close out of the window.

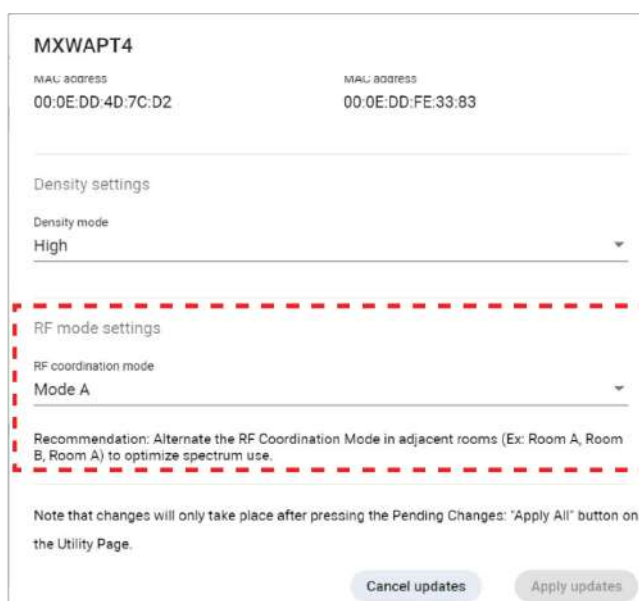

MXWAPT4

MAC address: 00:0E:DD:4D:7C:D2 MAC address: 00:0E:DD:FE:33:83

Density settings

Density mode: High

RF mode settings

RF coordination mode: Mode A

Recommendation: Alternate the RF Coordination Mode in adjacent rooms (Ex: Room A, Room B, Room A) to optimize spectrum use.

Note that changes will only take place after pressing the Pending Changes: "Apply All" button on the Utility Page.

Cancel updates Apply updates

5. Open the Device Properties for the adjacent APT2 or APT4.

6. Set the unit to Mode B (Device Properties > RF Mode Settings > RF Coordination Mode).
7. Select Add Updates to save the setting and close the window.
8. Make sure any additional APTs are set to alternating RF Coordination modes.
9. Select Apply All button on the Utility page to update all device settings.

Networking

Networking Best Practices

Use the following best practices when setting up a network to ensure reliable communication:

- Always use a "star" network topology by connecting each component directly to the switch or router.
- Connect networked MXW gear to the same network and set to the same subnet. This ensures best system performance and maximum microphone count.
- Use only 1 DHCP server per network. Disable DHCP addressing on additional servers.
- Power on the switch and DHCP server prior to MXW equipment.
- To expand the network, use multiple Ethernet switches in a star topology.
- Connect each device directly to the port of an Ethernet switch. Avoid "daisy-chaining" Ethernet port connections between devices for larger networks.
- Do not loop network connections.
- All devices must be at the same firmware revision level.

Configuring IP Settings

Go to the Utility tab of the control software to manage the IP configurations of each network interface. By default, they are set to Automatic (DHCP) mode. DHCP mode enables the devices to accept IP settings from a DHCP server, or automatically fall back to Link-Local settings when no DHCP is available. To manually set the IP address of an interface, select Manual (Static).

The MXW control software coordinates IP updates across the entire system of devices. To configure the IP properties, follow these steps:

1. Open the desired MXWAPT by double-clicking from the Devices view.
2. Go to the Utility tab.
3. Adjust IP settings for each device by selecting the Device Properties.

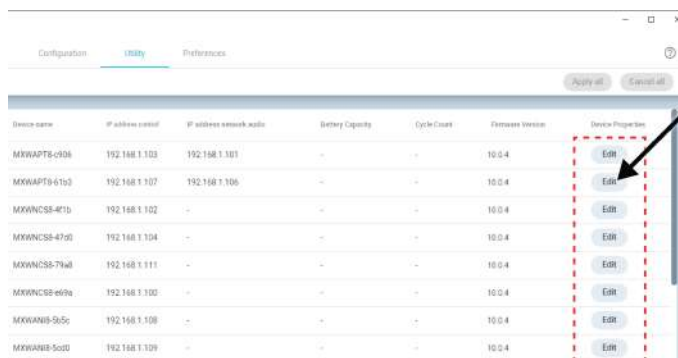

Device name	IP address control	IP address network mode	Battery Capacity	Cycle Count	Firmware Version	Device Properties
MKWAPTS-c90a	192.168.1.102	192.168.1.101	--	--	10.0.4	Edit
MKWAPTS-61s0	192.168.1.107	192.168.1.106	--	--	10.0.4	Edit
MKWANCSB-470	192.168.1.102	--	--	--	10.0.4	Edit
MKWANCSB-470	192.168.1.104	--	--	--	10.0.4	Edit
MKWANCSB-79a0	192.168.1.111	--	--	--	10.0.4	Edit
MKWANCSB-e60a	192.168.1.100	--	--	--	10.0.4	Edit
MKWANB-565c	192.168.1.108	--	--	--	10.0.4	Edit
MKWANB-5c00	192.168.1.109	--	--	--	10.0.4	Edit

4. After adjustments have been made, select Add Updates. This saves the settings to the changes queue.

MXWAPT8

General

Device name
MXWAPT8-61b3

Device serialnumber
4201420287

Factory reset Push to 'Device name' to dante Reboot

Network

Control Manual (Static) Auto (DHCP)

IP address
169.254.102.232

Subnetwork mask
255.255.0.0

Gateway
0.0.0.0

Control Manual (Static) Auto (DHCP)

IP address
169.254.197.116

Subnetwork mask
255.255.0.0

Gateway
0.0.0.0

Apply updates **Cancel updates**

5. Repeat for any additional components.
6. To send updates to the devices, select Apply All to the Pending Changes field of the Utility page.

ID	Device model	Device name	IP address	IP address (network audio)	Network Capacity	Link Speed	Network Status	Device Properties
1	MXWAPT8	MXWAPT8-61b3	169.254.102.232	169.254.197.116	-	-	10.0.0	Edit
2	MXWAPT8	MXWAPT8-61b3	169.254.102.232	169.254.197.116	-	-	10.0.0	Edit
1	MXWAPCSA	MXWAPCSA-4111	169.254.102.232	-	-	-	10.0.0	Edit
1	MXWAPCSA	MXWAPCSA-4111	169.254.102.232	-	-	-	10.0.0	Edit
Open	MXWAPCSA	MXWAPCSA-7548	169.254.102.232	-	-	-	10.0.0	Edit
Open	MXWAPCSA	MXWAPCSA-4111	169.254.102.232	-	-	-	10.0.0	Edit
1	MXWAPCSA	MXWAPCSA-4111	169.254.102.232	-	-	-	10.0.0	Edit
2	MXWAPCSA	MXWAPCSA-4111	169.254.102.232	-	-	-	10.0.0	Edit

Go to **Utility > Device Properties** to manage the interfaces of each MXW device on the network.

Network Audio and Shure Control Data

MXW devices transport two types of data over the network: Shure Control and Network Audio.

Shure Control

The Shure Control carries data for the control software operation, firmware updates and 3rd party control systems (AMX, Crestron). This data is transported to all MXW components connected to the network.

Network Audio

This network carries both the Dante digital audio and the control data for Dante Controller. This data is transmitted between the APT, the output device and the computer. The network audio requires a wired, gigabit Ethernet connection to operate.

The two data types are configured differently for each MXW device. Go to **Utility > Device Properties** to view and edit the IP settings for MXW devices.

Network Settings for Each MXW Device

MXW Device	Network Implementation for Audio and Control
Access Point Transceiver (APT)	Separate IP settings
Audio Network Interface (ANI)	Shared IP settings
Networked Charging Station (NCS)	Shure Control settings only. (The NCS does not transport network audio.)

Manually Assigning Static IP Address

To manually assign IP addresses to the MXW system, follow these steps:

1. Open the Utility tab.
2. Select Edit to open the device properties window.
3. Select the Manual (Static) IP Mode.
4. Enter the IP settings
5. Select the Add Updates button to queue the saved settings.
6. Repeat for all additional components
7. Finalize all updates by pressing the Apply All button from the Utility tab. All devices with pending changes will update.

Note: The control software may close if settings have been updated for the APT.

8. Change the computer's IP address to match the subnet of the MXW equipment.
9. Reopen the MXW control interface using the Shure Device Discovery application.

Advanced Setup

For more information on configuring advanced MXW networks, reference the Microflex Wireless Networking whitepaper located at www.shure.com.

Isolating Audio and Control Networks

When connecting to corporate or public networks, the MXW system can be configured to isolate audio network from the control network. This protects the audio from distributing to the entire network and significantly decreases network traffic.

The MXW Audio Network Interface (ANI) can be set to Uplink mode to dedicate one of its network ports as a control-only connection. Uplink mode blocks multicast traffic from Port 4 of the ANI, restricting network audio and Shure Discovery data.

Because the device will not show up in the Shure Device Discovery application, the IP address of the control software must be recorded to access the server.

1. Record the IP address of the ANI.
2. Connect Port 4 of the ANI to the network.
3. Open the ANI in the control software.
4. Go to the Preferences tab.
5. Under the Network panel, change Port 4 Mode to Uplink.

Operating the Control Software over Wi-Fi

When operating the MXW control software over Wi-Fi, it's important to set up the wireless router properly for best performance. The MXW System employs several standard-based protocols that rely on multicast. Wi-Fi treats broadcast and multicast packets differently than general packets for backward compatibility reasons. In some cases, the Wi-Fi router will limit the multicast packet transmission rate to a value that is too slow for GUI to properly operate.

Wi-Fi routers typically support 802.11b, 802.11a/g, and/or 802.11n standards. By default, many Wi-Fi routers are configured to allow older 802.11b devices to operate over the network. In this configuration, these routers will automatically limit the multicast data rates (or sometimes referred to as 'basic rate', or 'management rate') to 1-2Mbps.

Note: A Wi-Fi connection can only be used for the control software. Network audio cannot be transmitted over Wi-Fi.

Tip: For larger wireless microphone configurations, it's recommended to increase the multicast transmission rate to provide adequate bandwidth to the MXW control software.

Important: For best performance, use a Wi-Fi router that does not limit the multicast rate to 1-2 Mbps.

Shure recommends the following Wi-Fi router brands:

- Cisco
- Linksys
- Apple

Dedicate a Device for Leader Clock

Dante uses the IEEE 1588 Precision Time Protocol (PTP) to automatically select one device as the leader clock for all Dante devices on the network. PTP ensures that all devices are similarly clocked, which is critical for both audio delivery over the network and time-synced RF transmission over the wireless link. The leader clock in an MXW System is the first MXW access point that connects to the network. If several connect simultaneously, the access point with the lowest MAC address will be selected. Additional MXW components on the same network follow (synchronize to) this access point clock leader.

When a leader device shuts down or goes offline, the system will automatically begin selecting another leader. During this selection time (up to 30 seconds), the entire system will **NOT** pass audio.

If the network setup or building management requires that devices are periodically shut down, you can manually select an access point as the Preferred Master device from Dante Controller software. This allows the installer to set up the system to ensure that the leader access point never shuts down during events.

Setting Latency

Latency is the amount of time for a signal to travel across the system to the outputs of a device. To account for variances in latency time between devices and channels, Dante has a predetermined selection of latency settings. When the same setting is selected, it ensures that all Dante devices on the network are in sync.

The latency setting for Dante devices should be set according to the number of switches in the network. The MXW Audio Network Interface and Access Point both include an internal switch chip, which counts as a switch. For example, one network interface connected to an access point equals two switches.

Use Audinate's Dante Controller software to change the latency setting.

Latency Recommendations

Latency Setting	Maximum Number of Switches
0.25 ms	3
0.5 ms (default)	5

Latency Setting	Maximum Number of Switches
1 ms	10
2 ms	10+

Connecting to an External Control System

The MXW System connects to an AMX or Crestron control system via the Ethernet. Use only one controller per system to avoid messaging conflicts. For a comprehensive list of MXW command strings, visit: <https://pubs.shure.com/command-strings/MXW>

- Connection: Ethernet (TCP/IP; MXW is the client)
- Port: 2202

IP Ports and Protocols

Shure Control

Port	TCP/UDP	Protocol	Description	Factory Default
21	tcp	FTP	Required for firmware updates (otherwise closed)	Closed
68	udp	DHCP	Dynamic Host Configuration Protocol	Open
80*	tcp	HTTP	Required to launch embedded web server	Open
427	tcp/udp	SLP [†]	Required for inter-device communication	Open
843*	tcp	Flash	Required for web application	Open
2202	tcp	ASCII	Required for 3rd party control strings	Open
5353	udp	mDNS [†]	Required for device discovery	Open
5568	udp	SDT [†]	Required for inter-device communication	Open
8180*	tcp	Flash	Required for web application	Open
8181*	tcp	Flash	Required for web application	Open
8427	udp	Multicast SLP [†]	Required for inter-device communication	Open
64000	tcp	Telnet	Required for Shure firmware update	Open

Dante Audio & Controller

Port	TCP/UDP	Protocol	Description
[319-320]*	udp	PTP [†]	Dante clocking
4321, 14336-14600	udp	Dante	Dante audio
[4440, 4444, 4455]*	udp	Dante	Dante audio routing

Port	TCP/UDP	Protocol	Description
5353	udp	mDNS [†]	Used by Dante
[8700-8706, 8800]*	udp	Dante	Dante Control and Monitoring
8751	udp	Dante	Dante Controller
16000-65536	udp	Dante	Used by Dante

*These ports must be open on the PC or control system to access the device through a firewall.

[†]These protocols require multicast. Ensure multicast has been correctly configured for your network.

Packet Bridge

Packet bridge enables an external controller to obtain IP information from the control interface of a Shure device. To access the packet bridge, an external controller must send a query packet over **unicast UDP*** to **port 2203** on the Dante interface of the Shure device.

1. Send a UDP packet with a minimum 1-byte payload .

Note: The maximum accepted payload 140 bytes. Any content is allowed.

2. The Shure device will send a response packet over unicast UDP to the controller, using a destination UDP port identical to the source port of the query packet. The payload of the response packet follows this format:

Bytes	Content
0-3	IP address, as 32-bit unsigned integer in network order
4-7	Subnet mask, as 32-bit unsigned integer in network order
8-13	MAC address, as array of 6 bytes

Note: The Shure device should respond in less than one second on a typical network. If there is no response, try sending the query again after verifying the destination IP address and port number.

*UDP: User Datagram Protocol

Software

MXW System Control Software

The MXW control software allows comprehensive system control and monitoring from a computer. It is hosted from an embedded server in the MXW Access Point, and is accessible when properly networked to a computer. All hardware functions can be adjusted using this software interface.

Devices List

The MXW Control Software opens by default to the Devices list.

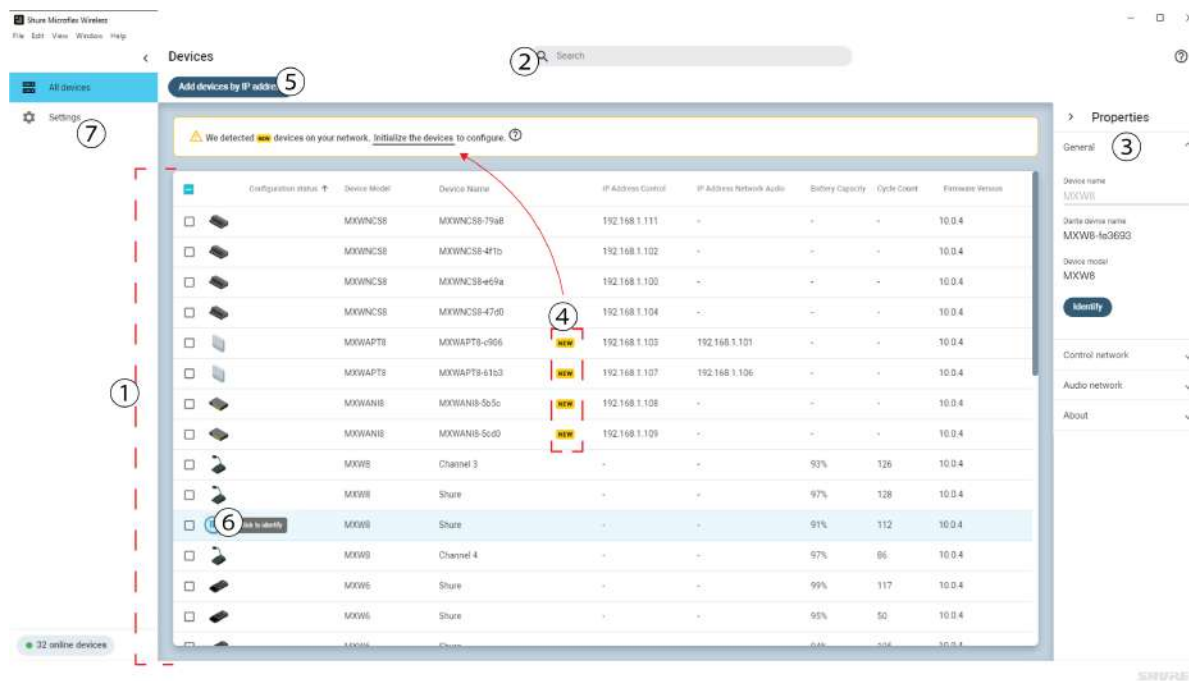

① Devices List:	Click a device to view its properties. Double click a device to open it.
② Search Bar:	Search for a connected device by name.
③ Properties Pane:	View identity, control, audio, and technical information for the selected device.
④ New Devices:	Click "Initialize the devices" to set a passphrase for new devices.
⑤ Add Devices by IP Address	Add cross-subnet devices, manually or from a file.
⑥ Identify:	Hover over the device's icon to display this button, which sends a command to the hardware to flash front-panel LEDs for easy identification.
⑦ Settings:	Open the global Settings menu.

Add Devices by IP Address

Microflex Wireless software automatically discovers supported Shure devices on the same subnet and you can add cross-subnet devices manually or from a file. The file must be a .txt or .csv format, with IP addresses delimited by a space, comma, or new line.

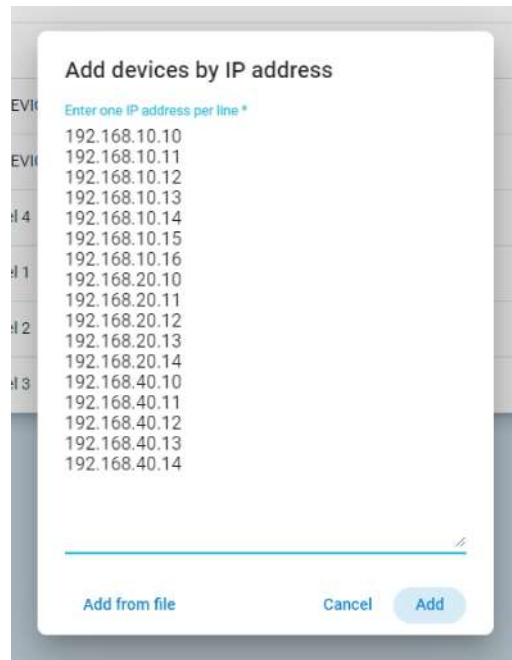

You can clear any unwanted or undiscoverable IP addresses from the Devices list by selecting those rows and clicking "Forget devices."



Note: To access your MXWANI in uplink mode via Port 4, manually enter the IP addresses of the ANI and its connected devices, as automatic discovery will be blocked.

Settings

Manage the global settings for your MXW system.

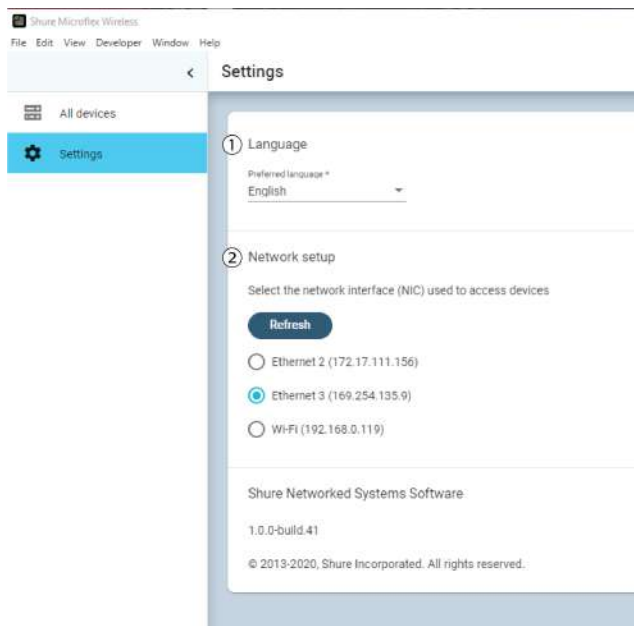

① Language:	Selects the language for the control software interface. This setting will be saved to the computer.
② Network Setup:	Select the network interface or refresh the list of available network interfaces.

Using a Passphrase

The software application must have an Admin passphrase created when a device is powered on for the first time, or after a factory reset. The passphrase may be changed from the Preferences tab in **Admin view**.

Sign In Page

Double-click into an initialized device to sign in and use the software to control that device's settings.

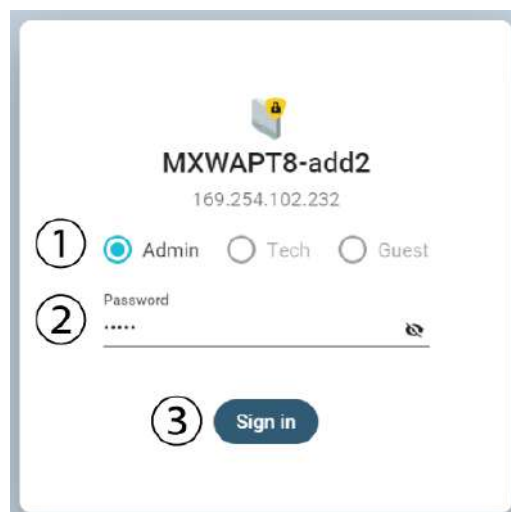

① User

There are three security levels to the Control Software: Admin, Tech and Guest. By default, only Admin is enabled. Log on and go to the Preferences tab to manage the User log on.

Admin (default): Full editing rights. The Admin can enable or disable a Tech-level logon.

Tech: Partial editing rights, limited to microphone management on the Monitor tab.

Guest: Monitoring only.

② Password

Enter the passphrase to log on as an Admin or Tech. To change the passphrase, log in as an Admin and go to the Preferences tab.

③ Sign In Button

Press the button to log onto the control software.

Monitor Tab

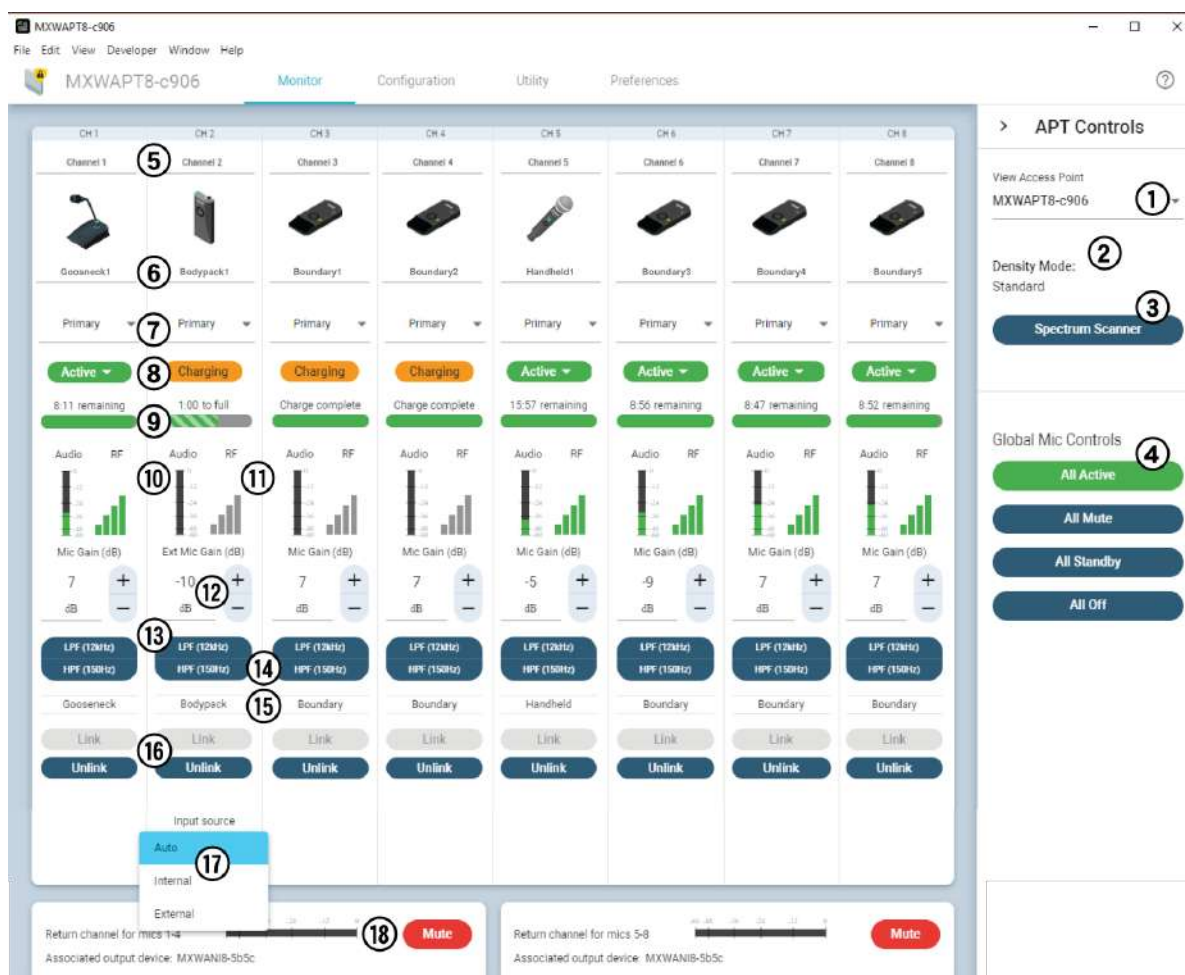

① Access Point Selection

Determines which Access Point displays on the tab.

② Density Mode Selection

Displays the density mode as selected in the APT device properties.

③ Spectrum Scanner

Opens the Spectrum Scanner window. See Scanning Available RF Spectrum section for more details.

④ Global Mic Control

Controls the status of all microphones in the configuration (all groups made from the Configuration tab).

⑤ Channel Name

Channel names are customizable for channel (RF and Audio) identification. The name is associated with the channel on the APT, will be stored on it, and is independent from the microphone linked to that channel.

⑥ Device Name

Device names are customizable for microphone identification. The name is associated with the registered microphone, will remain stored on it, and is independent from the channel it is linked to.

⑦ Microphone Link Slot

Selects the which microphone displays on the channel strip.

Note: One microphone is on-air per channel, though an alternate microphone can be prepared in the secondary link slot.

⑧ Microphone Status and Control

View or change the microphone state:

- **Active:** On and passing audio to the network.
- **Mute:** On but the audio is muted.
- **External:** On and passing audio to an external controller that controls the mute/active behavior.
- **Standby:** On but in a 'sleep' state with audio muted. Standby conserves battery charge and enables a change to the microphone's status from the control software.
- **Charging:** Battery is charging.
- **Inactive:** Off or out-of-range. A microphone in this state cannot be remotely controlled by the software.
- **Power Off:** Turn off the microphone.

⑨ Battery Status

- **In the charger:** Displays the remaining time until the microphone battery is fully charged
- **Out of the charger:** Displays the remaining battery runtime of the microphone.

⑩ Audio Input Meter

Indicates the average input signal level.

Color	Audio Signal Level (dBFS)	Description
Red	0 to -9	Overload
Yellow	-9 to -18	Normal peaks
Green	-18 to -60	Signal Present

⑪ RF Signal Strength

Indicates the signal strength of the microphone. When the bars are grey, the microphone is out of range.

⑫ Mic Gain

Adjusts microphone gain from -25 dB to +15 dB gain in 1 dB steps.

⑬ Low-Pass Filter

Engages a 6 dB-per-octave filter above 12 kHz for attenuating undesired high frequencies, sometimes caused by sibilant vocals or paper rustling. Automatically enabled in HCD mode.

⑭ High-Pass Filter

Engages a 12 dB-per-octave filter below 150 Hz for attenuating undesired low frequencies, sometimes caused by table vibrations or air-conditioning rumble. Automatically enabled in high channel density mode (HCD).

⑮ Microphone Type

Displays the microphone type.

⑯ Link/Unlink Buttons

For setting up a single audio channel. Links the microphone to the primary or secondary link slot (as selected at the top of the channel strip).

- **Link:** Links the microphone from the corresponding charging slot.
- **Unlink:** Unlinks the microphone from the audio channel.

⑰ Bodypack Mic Options

There are two input sources available on the MXW1 bodypack: the internal, omnidirectional microphone or the external, TQG input for lavalier or headset microphones. Select the input source preference:

- **Auto:** The internal mic is used until the MXW1 detects a connection at the TQG input. The microphone automatically selects the external source whenever available.
- **Internal:** Audio source is always from the internal microphone.
- **External:** Audio source is always from a connected microphone. (Internal mic is off.)

Note: When an MX153 earset headworn microphone is connected, make sure External input is manually selected.

⑱ Return Channels

Monitor the signal level and mute/unmute the audio of the return channel. Disabled in high density mode (HD).

Configuration Tab

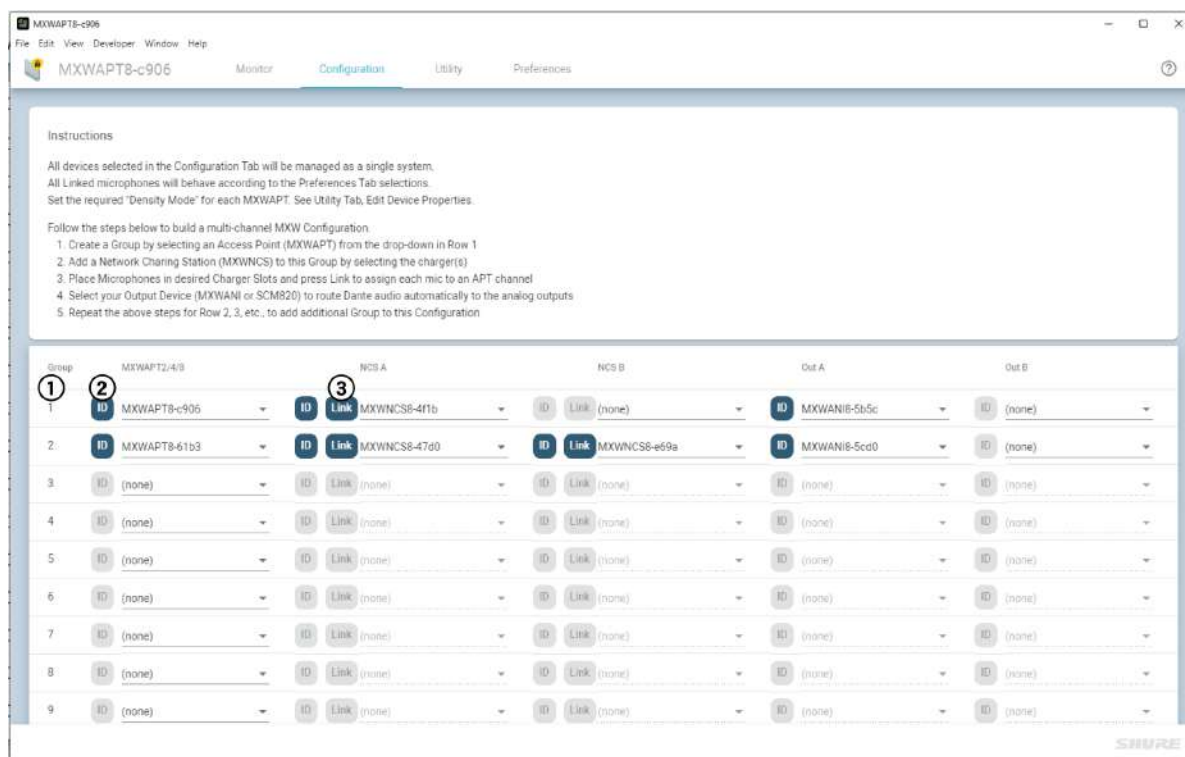

① Group Row

Each row represents a Group in the Configuration. Select an APT and associate chargers and audio output devices to form each Group.

② ID Button

Commands the selected device's LEDs to flash for easy identification.

③ Link Button

Links all microphones in the charger to channels in the associated Group.

Link Microphones

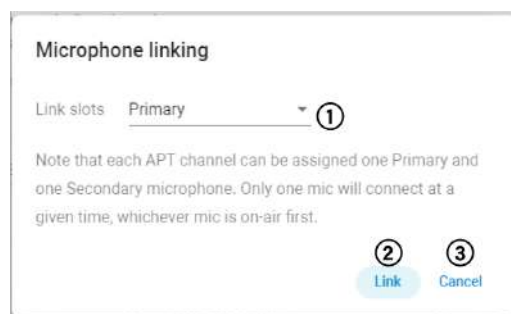

Link all microphones in the charger to the access point audio channels.

Up to two microphones can link to each audio channel, though only one is on air at-a-time. Use the secondary link slot to add a microphone for battery redundancy or flexibility during events.

① Link Slot Selection

Up to two microphones link to each audio channel using the primary and secondary link slots. The secondary link slot is useful for an additional or alternate microphone that can be prepared before the event.

② Link Button

Links microphones in the charger to audio channels.

③ Cancel Button

Cancels the link procedure.

Utility Tab

The screenshot shows the 'Utility' tab of the MXWAP8-c906 software. The table lists various devices with their properties and an 'Edit' button for each. The columns are numbered 1 through 11, corresponding to the callouts in the text below.

①	②	③	④	⑤	⑥	⑦	⑧	⑨	⑩	⑪
Export	Group	Device model	Device name	IP address control	IP address network audio	Battery Capacity	Cycle Count	Firmware Version	Device Properties	
	1	MXWAPT8	MXWAPT8-c906	192.168.1.103	192.168.1.101	-	-	10.0.4	Edit	
	2	MXWAPT8	MXWAPT8-61b3	192.168.1.107	192.168.1.106	-	-	10.0.4	Edit	
	1	MXWNCS8	MXWNCS8-4f1b	192.168.1.102	-	-	-	10.0.4	Edit	
	1	MXWNCS8	MXWNCS8-47d0	192.168.1.104	-	-	-	10.0.4	Edit	
	Open	MXWNCS8	MXWNCS8-79a8	192.168.1.111	-	-	-	10.0.4	Edit	
	Open	MXWNCS8	MXWNCS8-e69a	192.168.1.100	-	-	-	10.0.4	Edit	
	1	MXWAN18	MXWAN18-5b5c	192.168.1.108	-	-	-	10.0.4	Edit	
	2	MXWAN18	MXWAN18-5cd0	192.168.1.109	-	-	-	10.0.4	Edit	
	1	MXW6	Shure	-	-	99%	117	10.0.4	Edit	
	1	MXW6	Channel 4	-	-	95%	50	10.0.4	Edit	
	1	MXW6	Shure	-	-	94%	105	10.0.4	Edit	
	1	MXW8	Shure	-	-	93%	126	10.0.4	Edit	
	1	MXW2	Shure	-	-	86%	66	10.0.4	Edit	
	1	MXW8	Channel 4	-	-	97%	128	10.0.4	Edit	

① Export Button

Exports MXW device data to a text file (.csv).

② Device

The device type or microphone channel.

- **APT:** Access point transceiver; also displays the selected channel density mode (SD = standard, HD = high)
- **NCS:** Network charging station, up to two per group (A or B)
- **Mic 1 - 8:** Microphone for channels 1-8, up to two microphones per channel (primary or secondary)
- **Out:** Device is not associated or linked to a group

③ Group

Indicates the device's status in a Group:

- **1 - 10:** Device is associated to that Group in the Configuration
- **Open:** Device is not associated to any group
- **None:** Microphone is linked to an Access Point that has been removed from a group (deselected from the Group row in the Configuration tab)
- **Standalone:** Audio Network Interface is set to Standalone mode, which restricts association to an APT group
- **Unknown:** Microphone is linked to an APT that is powered off or connected to a different network
- **Other:** Device is associated to a Group in a different Configuration

④ Device Model

The device model number.

⑤ Device Name

Displays device name as defined in the Configuration tab or channel name as defined in the Monitor tab.

⑥ IP Address

Displays the IP Address of the control network interface (Shure control data).

⑦ IP Address Network Audio

Displays the IP Address of the Network Audio network interface (Dante digital audio data).

⑧ Battery Capacity

The microphone battery's percentage of charge capacity as compared to a new battery.

⑨ Cycle Count

Number of charge cycles logged by the battery.

⑩ Firmware Version

Displays the device's firmware version.

⑪ Device Properties

Opens a window for editing the properties of an individual device. The button displays yellow when the properties have been edited for that device. The changes can be applied or cancelled from the Pending Changes Button on the Utility tab.

⑫ Pending Changes Buttons

These buttons apply or cancel any changes made to the device properties:

- **Apply All:** Confirms and executes all updates to device properties. At this time, the computer may lose connection to the control software.
- **Cancel All:** Clears all pending changes to the device properties.

Device Properties

Edit the settings for each device by opening the Device Properties window from the Utility tab. Device properties are edited individually, but are uploaded to the devices in bulk by selecting the Apply All button from the Utility tab. This ensures that the changes are deployed properly across the network.

Some settings vary depending on the device capabilities.

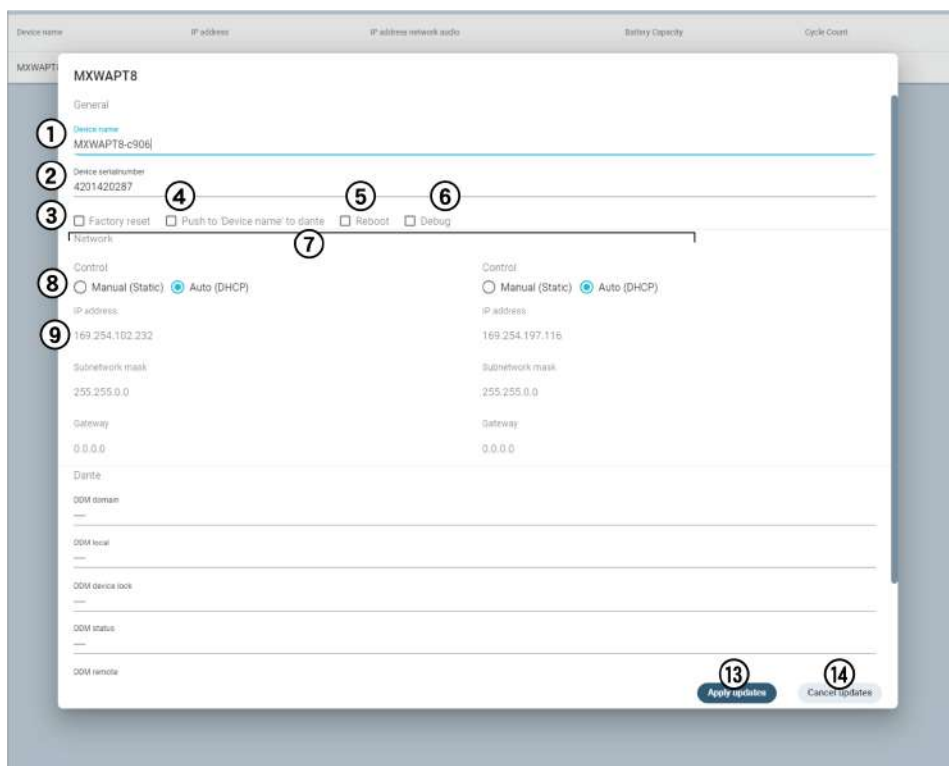

APT8 Properties Window

① Device Name

Device names can be customized with up to 31 characters.

② Serial Number

The unique identifier used to register the device at the Shure website, guarantee the warranty, and troubleshooting with customer support.

③ Factory Reset

Resets the device to default settings, clearing any MXW Group and Link associations. The passphrase to access the control software will be reset.

④ Push to 'Device name' to Dante

Uses the device and channel name from the MXW web interface to overwrite the names in the Dante Controller (DC) software by Audinate.

Note: Use with caution, as this could break the routing configuration previously made in DC, causing audio interruptions.

⑤ Reboot

The unit performs a power cycle.

⑥ Debug Mode

For use by Shure Support personnel only. If selected, a power cycle is needed to resume normal operation.

⑦ Network Interface(s)

View and adjust IP settings for the device's network interface(s). Network settings are different for each device. See the Networking section for configuring each MXW device.

- **Control:** Shure control (software interface operation, firmware updates, Shure Device Discovery application).
- **Dante:** Dante network audio (digital audio networking and Dante software).

⑧ IP Mode

Sets IP mode of the selected network interface:

- **Auto (DHCP):** For automatic assignment of IP addresses.
- **Manual (Static):** For Static IP addresses.

⑨ IP Settings

View and edit the IP Address, Subnet Mask, and Gateway for each network interface.

⑩ MAC Address

The network interface's unique identification.

⑪ Density Mode

Sets the density mode set on the APT:

- Standard density (default)
- High density (doubles the available channels)

⑫ RF Mode Settings

For APT2 and APT4 installed in adjacent rooms, alternate modes (Mode A, Mode B) to get the best RF performance.

⑬ Apply Updates

Select Apply Updates to save the device changes to the control software. All device properties are updated simultaneously from the Utility tab. Once saved, the device will show Pending under the Properties column.

⑭ Cancel Updates

Remove any changes made to the device properties.

Preferences Tab

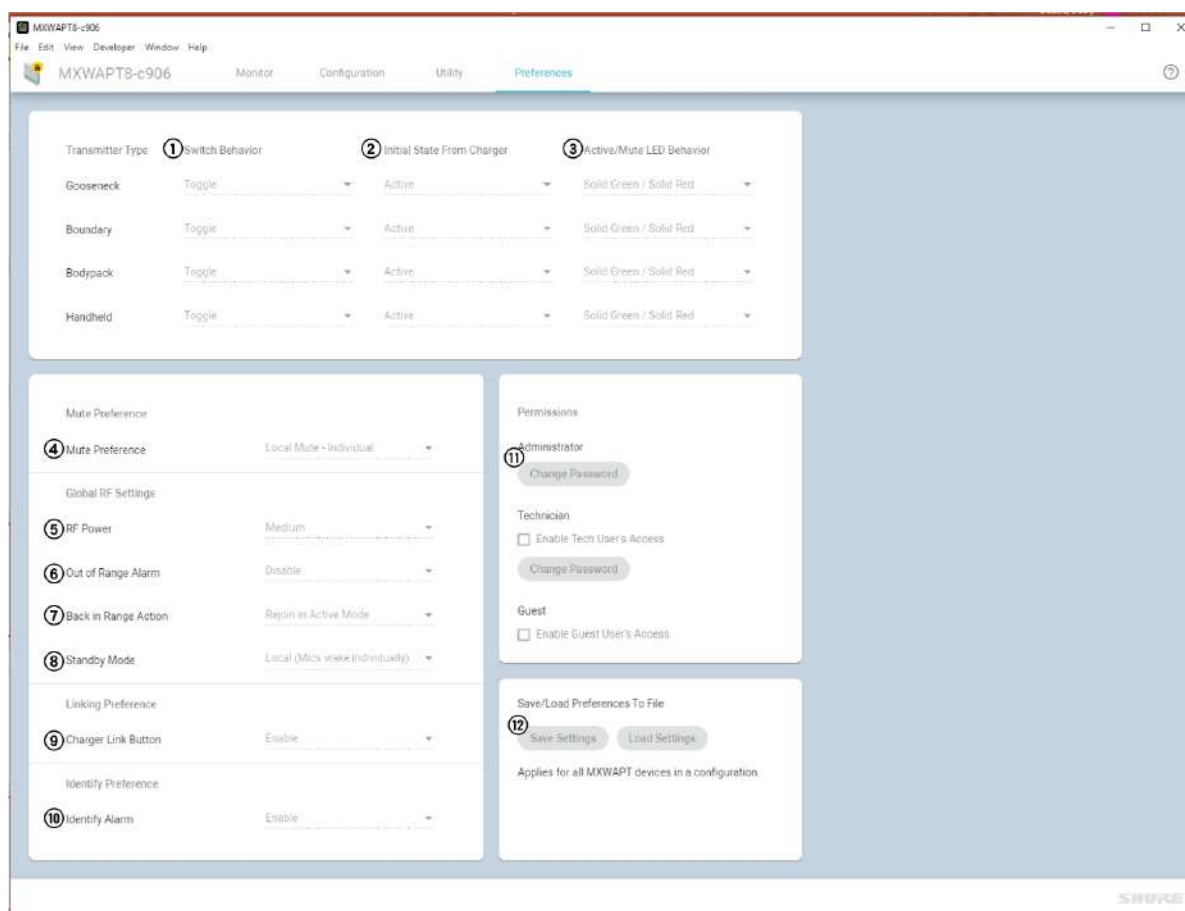

All preferences apply to each device in the Configuration.

① Switch Behavior

Customize the switch on each transmitter type.

- **Toggle (default):** Press and release the button to change the status to Active or Mute.
- **Push-to-talk:** Hold button to pass audio.
- **Push-to-mute:** Hold button to mute the audio.
- **Disabled:** The button does not affect the audio.

② Initial State from Charger

Assigns the state for the transmitter after it has been removed from the charger:

- **Active:** On and passing audio to the network.
- **Mute:** On but the audio is muted.
- **Standby:** On but in a 'sleep' state with audio muted. Standby conserves battery charge and enables a change to the transmitter's status from the control software.
- **Off:** Power is off. A transmitter in this state cannot be remotely controlled by the software.

Note: These settings only apply to standard mode; transmitters in high efficiency mode are always powered off when removed from the charger.

③ Active/Mute LED Behavior

Set the behavior of the mute/active LED for each transmitter type. Standby mode is always represented with a pulsing red LED.

Active	Mute
Solid Green*	Solid Red
Solid Red	Flashing Red
Solid Red	Off
External LED Control	

*Not available for MX400R series gooseneck microphones

④ Mute Preference

- **Local Mute - Individual (default):** Each transmitter is muted individually.
- **Local Mute - All:** All transmitters mute when any transmitter is muted.
- **External Mute:** Transmitter audio is on, and muted from a 3rd-party controller.

⑤ RF Power

Determines the RF coverage of an access point.

- **Low:** 25 ft (1mW)
- **Medium:** 50 ft (3 mW)
- **Medium High:** 100 ft (16 mW)
- **Max:** 150 ft (80 mW)

⑥ Out of Range Alarm

When enabled, a transmitter will audibly beep when it is taken out of the RF coverage area. (Disabled by default.)

⑦ Back in Range Action

Transmitters can be set to automatically activate (default) or mute when they re-enter the RF coverage area.

⑧ Standby Mode

- Local (default): Transmitter can individually be activated.
- Global: All transmitters are activated at the same time from Standby mode.

⑨ Linking Preference

The Link procedure can be restricted to the control software by disabling the hardware Link button on the Networked Charging Station. By default, the Link button is enabled.

⑩ Identity Preference

Determines the way the transmitter responds when it is identified from the control software:

- **Enabled:** Beeps with flashing LEDs
- **Disabled:** Flashing LEDs only (no sound)

⑪ Permissions

The following describes access rights for each logon:

Admin (default): Full monitoring and editing access. The Admin can enable or disable the Tech- and Guest-level logon.

Tech: Monitoring with limited editing access.

Guest: Monitoring only.

⑫ Save/Load Preferences

Saves the preferences of the Configuration as a file to the computer. The file can be loaded and will overwrite the settings for all devices in the Configuration.

Control Software for the MXW Audio Network Interface

The MXW Audio Network Interface enables the control software to manage the analog inputs and outputs of the MXW system, in addition to the 4-port gigabit switch on the back panel of the network interface.

Sign In Page

Double-click into an initialized device to sign in and use the software to control that device's settings.

The screenshot shows a sign-in interface for a device. At the top, there is a lock icon, the device name 'MXWAN18-0b96', and the IP address '169.254.102.232'. Below this, there are three radio buttons for user selection: 'Admin' (which is selected), 'Tech', and 'Guest'. A password field is labeled 'Password' and contains six dots. A 'Sign in' button is located at the bottom. Three numbered callouts (1, 2, 3) are overlaid on the image to indicate the steps: 1 points to the 'Admin' radio button, 2 points to the password field, and 3 points to the 'Sign in' button.

① User

There are three security levels to the Control Software: Admin, Tech and Guest. By default, only Admin is enabled. Log on and go to the Preferences tab to manage the User log on.

Admin (default): Full editing rights. The Admin can enable or disable a Tech-level logon.

Tech: Partial editing rights, limited to microphone management on the Monitor tab.

Guest: Monitoring only.

② Password

Enter the passphrase to log on as an Admin or Tech. To change the passphrase, log in as an Admin and go to the Preferences tab.

③ Sign In Button

Press the button to log onto the control software.

Channels Tab

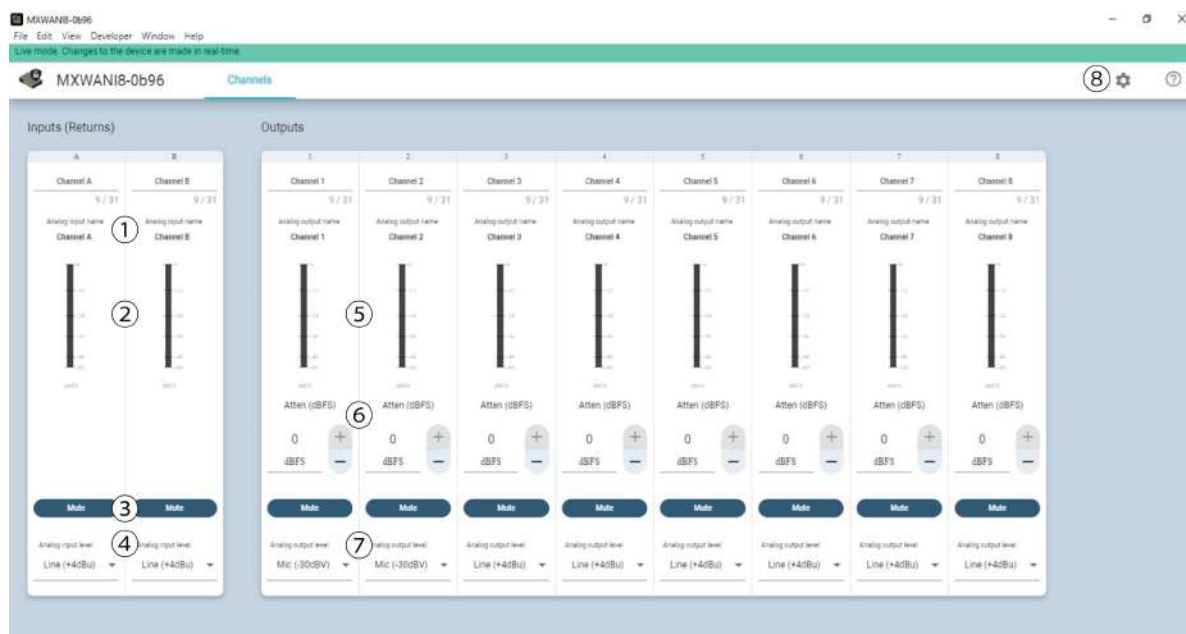

① Channel Name

Channel name is customizable by clicking in the text box. Names can be up to 12 characters long.

② Input Audio Meter

Displays input audio levels prior to the analog-to-digital converter.

③ Mute Button

Mutes or unmutes the channel's audio. The button illuminates red when a channel is muted.

④ Analog Input Level (A, B)

Sets the analog input gain level: Line (default) or Aux.

⑤ Output Audio Meter

Displays output audio levels prior to the digital-to-analog converter.

⑥ Attenuation

Output attenuation is adjustable in 1 dB increments.

⑦ Analog Output Level

Sets the output gain level.

⑧ Settings

Opens the settings pane for the network interface.

Settings Pane



① General

View or modify basic information about the selected device.

② Network

Configure the network settings for your device.

③ Firmware

Displays the current firmware version of the device.

④ Front Panel Lockout

Disables the front panel controls on the hardware. Channels can still be selected for monitoring at the headphone jack.

⑤ Permissions

The Administrator password is created when the interface is powered on for the first time, or after a factory reset. Technician and Guest permissions can be activated or deactivated and passwords can be changed from this screen.

- **Administrator (default):** Full editing rights. The Admin can enable or disable a Tech-level logon.
- **Technician:** Rights are limited to the Inputs/Outputs page (hardware functions only).
- **Guest:** Monitoring only.

⑥ Factory Reset

Reboots, restore factory default settings, or enter debug mode.

General Settings

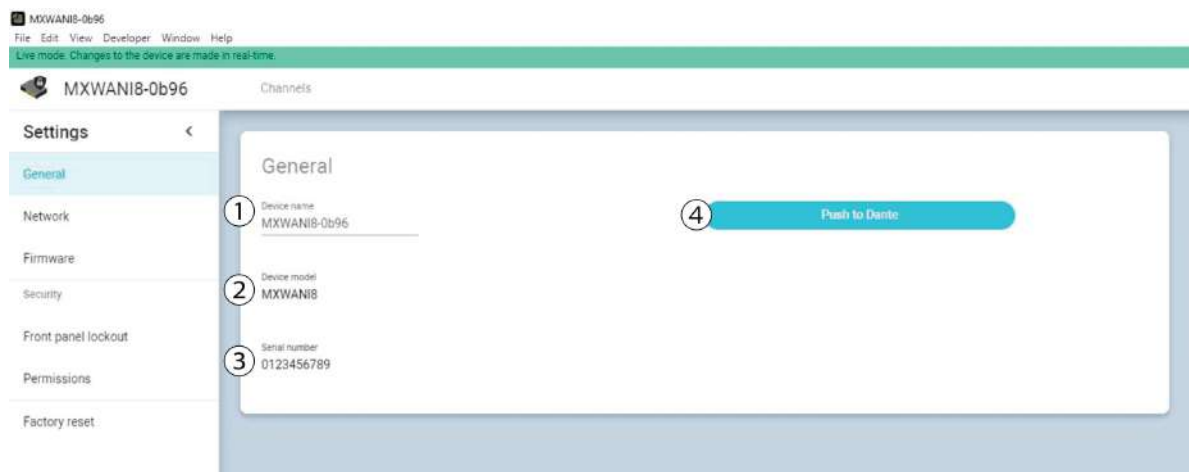

① Device Name

Device names can be customized with up to 31 characters, except '=', ':', or '@'.

② Device Model

The device model number.

③ Serial Number

The unique identifier used to register the device at the Shure website, guarantee the warranty, and troubleshooting with customer support.

④ Push to Dante

Uses the device and channel name from the MXW web interface to overwrite the names in the Dante Controller (DC) software by Audinate.

Network Settings

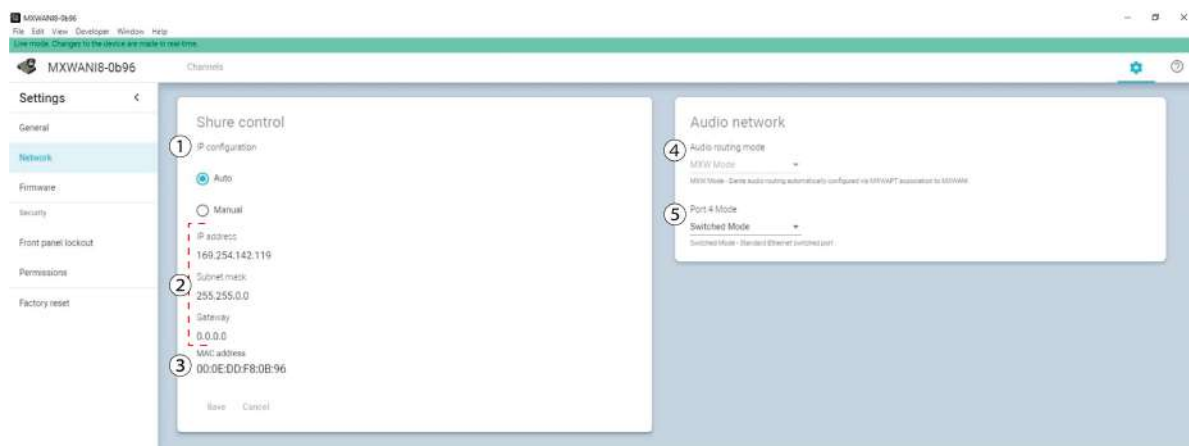

① Addressing Mode

Auto: IP settings are Link-Local or automatically accepted from a DHCP server.

Manual: IP settings (IP Address, Subnet Mask, and Gateway) are static and are entered manually.

② IP Settings

View and edit the IP Address, Subnet Mask, and Gateway for each network interface.

③ MAC Address

Unique identifier assigned to each network interface.

④ Audio Routing Mode

- **MXW Mode:** Enables automatic channel routing when the device is a part of an MXW group (assigned from the MXW System control software).
- **Standalone Mode:** Channels must be routed manually with Dante Controller software.

⑤ Port 4 Mode

Configures the Port 4 of the network interface:

- **Switched Mode (default):** Full Ethernet support on port 4.
- **Uplink Mode:** Only control data is transported. Multicast traffic for Dante digital audio and the Shure Web Device Discovery application is restricted.

Dante Software by Audinate

Audinate software provides additional function and control of the Dante digital audio network. Visit Audinate's website for instructions for download and installation.

Dante Controller

Dante Controller (DC) is free software by Audinate that is used to configure and manage a network of Dante devices. Use it to route channels between Dante-enabled devices and to monitor the status of the device, clock, and network.

Important: The MXWAPT must be the Dante clock leader for the network. Do not change the clock leader from the MXWAPT (default selection) to another device.

Note: DC software is not required for routing audio within the MXW system. Use caution when using DC, as changing settings may interfere with MXW system functionality.

Compatibility with Dante Domain Manager

This device is compatible with Dante Domain Manager software (DDM). DDM is network management software with user authentication, role-based security, and auditing features for Dante networks and Dante-enabled products.

Considerations for Shure devices controlled by DDM:

- When you add Shure devices to a Dante domain, set the local controller access to Read Write. Otherwise, you won't be able to access Dante settings, perform a factory reset, or update device firmware.
- If the device and DDM can't communicate over the network for any reason, you won't be able to control Dante settings, perform a factory reset, or update device firmware. When the connection is reestablished, the device follows the policy set for it in the Dante domain.
- If Dante device lock is on, DDM is offline, or the configuration of the device is set to Prevent, some device settings are disabled. These include: Dante encryption, MXW association, AD4 Dante browse and Dante cue, and SCM820 linking.

Refer to [Dante Domain Manager's documentation](#) for more information.

Note: While MXWAPT devices are fully DDM-compatible, MXWANI devices must either be placed in an unmanaged domain, or associated with a domain in Legacy Interop mode. This allows sharing of audio with other devices in that domain, but access to the MXWANI is not controlled through DDM.

Dante Virtual Soundcard

Dante Virtual Soundcard (DVS) acts as an audio driver used to monitor and record digital audio without additional equipment. DVS uses a computer's standard Ethernet ports to transmit and receive up to 64 channels from any Dante enabled device on the same network.

Firmware Updates

Firmware is embedded software in each component that controls functionality. Periodically, new versions of firmware are developed to incorporate additional features and enhancements. To take advantage of design improvements, new versions of the firmware can be uploaded and installed using the Shure Update Utility. Download the software from www.shure.com.

Perform the following steps to update the firmware:

CAUTION! Ensure the device has a stable network connection during the update. Do not turn off the device until the update is complete.

1. Connect the device and computer to the same network (set to the same subnet).
 - To update MXW transmitters, place them in the MXW Networked Charging Station that is connected to the same network.
 - If the MXW Audio Network Interface is connected via Port 4, ensure that the Network mode is set to Switched mode (default) from the Preferences tab of the ANI control software.
2. Open the Shure Update Utility application.
3. Click Check For Updates... button to view new firmware versions available for download.
4. Select the desired firmware and press Download to download it to the Firmware Library.
5. From the Update Devices tab, select the new firmware and press Send Updates... to begin the firmware update, which overwrites the existing firmware on the device.

Firmware Release Requirements

Microflex Wireless devices comprise a network with multiple communications protocols that work together to ensure proper operation. The recommended best practice is that all MXW devices are on an identical release. To view the firmware of each MXW device on the network, open the Utility page of the MXW control software.

The format for Shure device's firmware is MAJOR.MINOR.PATCH. (Ex. 1.6.2 where 1 is the Major firmware level, 6 is the Minor firmware level, and 2 is the Patch firmware level.) At minimum, **devices that operate on the same subnet should have identical MAJOR and MINOR release numbers.**

Troubleshooting

The following table offers typical solutions when troubleshooting the Microflex Wireless System.

Audio

Problem	Indicator	Solution
No or distorted audio	Network Audio LED on the Audio Network Interface or SCM820 Green	Check cables Check that transmitters are on and channels are un-muted Check that the input meters are OK on the Monitor tab of the MXW control software. Attenuate if the channel is clipping.

Problem	Indicator	Solution
		<p>Check the output meters on the Audio Network Interface (ANI) front panel and in the ANI control software. Use headphones to listen to the audio from the ANI. Attenuate if the channel is clipping.</p> <p>Check that the output level of the ANI matches the input of the connecting equipment</p> <p>Verify APT is not performing a spectrum scan</p>
	Flashing Green	<p>Ensure all devices are on and have a stable network connection</p> <p>Use Dante Controller software (DC) to verify channel subscriptions</p>
	Red	<p>Check leader clock in DC (an MXWAPT must be leader clock)</p>
	Off	<p>Place the device in a Group to automatically route the audio</p> <p>Ensure the subnet of the Access Point Transceiver's network audio settings match the subnet of the Audio Network Interface</p>
Audio is cutting in an out (intermittent)	Audio is intermittent	<p>Perform a Spectrum Scan to monitor RF interference</p> <p>Decrease channel count to verify if system is overloading the RF spectrum</p>

System Setup and MXW Groups

Problem	Indicator	Solution
Can't associate component to a Group	Device drop-down not displaying the desired component in the Group row on the Configuration tab	<p>Check that devices are powered and connected to the same network and subnet)</p> <p>Open the Utility tab of the MXW Control Software and un-check the Configuration Filter to display all MXW devices on the network. If the device shows up as "OTHER", then it is part of another Configuration.</p> <p>Un-associate the component by selecting 'none' from the Group row in the other Configuration</p> <p>Perform a factory reset on the device to clear any association</p>

Network and Device Monitoring

Problem	Indicator	Solution
Control Software is taking a long time to load	Software cannot connect to the control interface	<p>Ensure PC and device are on the same network and subnet</p> <p>Check that Windows firewall settings are not blocking Shure software</p> <p>Set the router to not send default gateway as a part of DHCP</p> <p>Set the Shure Web Device Discovery application to open by IP address</p> <p>Manually set the computer to a static IP address on the same network as the device</p>

Problem	Indicator	Solution
Control Software is performing poorly	Indicators are moving slowly or not displaying in real time	Reduce the number of windows or tabs that are open to the same Configuration See Network section for properly setting up the network
Charger is not discovered by the Control Software	The charger does not appear in the UI	Ensure that the MXWNCS charger is not in High Efficiency Mode (solid blue Microphone Link LED)

Additional Resources

For additional Troubleshooting assistance or further information on complex installations, visit <https://www.shure.com/support> or contact your local Shure service center.

For digital audio networking help, advanced networking guidelines and Dante software troubleshooting, visit Audinate's website at www.audinate.com.

Factory Reset

If a device isn't appearing on the network after trying troubleshooting methods, perform a reset on the specific hardware to return the device to default settings. Factory default settings are designed for automatic compatibility with other Shure networked devices.

Note: A factory reset will clear any MXW Group and Link associations. A new passphrase to access the software will be required.

From the Hardware

Access Point Transceiver

Press and hold the recessed reset button for 10 seconds. The network audio status LED will briefly turn off to indicate the unit is rebooting.

CAUTION: A factory reset deletes all Group associations and microphone Links saved in the device.

Audio Network Interface

Press and hold the reset button for 10 seconds. The front panel LEDs will flash to indicate the unit is rebooting.

Networked Charging Station

1. Turn off the power switch.
2. Press and hold the Link button.
3. While holding the Link button, turn on the power switch.
4. Continue to hold the Link button for 12 seconds until the LED illuminates amber.

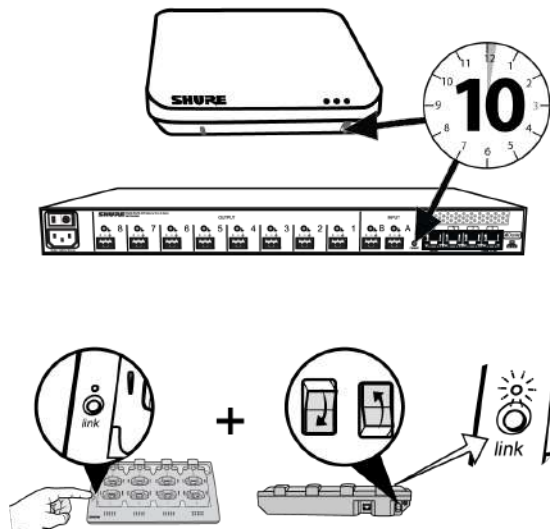

From the Control Software

1. Open the Utility Tab of the MXW control software.
2. Select the Edit Properties button for the device.
3. Select the factory reset check-box.
4. Select Add Updates to save the setting to the edits queue.
5. Repeat for any additional devices.
6. Press the Apply All to make changes to all devices with edited properties.

Accessories and Model Variations

MXW Device	Description	Part Number
Access Point Transceiver	8-Channel Access Point Transceiver	MXWAPT8
	4-Channel Access Point Transceiver	MXWAPT4
	2-Channel Access Point Transceiver	MXWAPT2
	Mounting Plate	65A20096
	Paintable Cover	65A20030
Audio Network Interface	8-Channel Audio Network Interface	MXWANI8
	4-Channel Audio Network Interface	MXWANI4
	Hardware Kit	90A20081
	IEC Cable	Varies by region; see table
Network Charging Station	8-Channel Audio Network Interface	MXWNCS8

MXW Device	Description		Part Number
	4-Channel Audio Network Interface		MXWNCS4
	2-Channel Audio Network Interface		MXWNCS2
	Power Supply		PS60
Transmitter	Bodypack Transmitter	MXW bodypack transmitter (without lavalier microphone)	MXW1/O
		Lavalier microphone	See table
		Battery	SB901A
	Handheld	SM58	MXW2/SM58
		SM86	MXW2/SM86
		Beta58	MXW2/BETA58
		VP68	MXW2/VP68
		Battery	SB902
		Battery	SB905*
	Boundary	Omnidirectional	MXW6/O
		Cardioid	MXW6/C
		White omnidirectional	MXW6W/O
		White cardioid	MXW6W/C
		Battery	SB901A
	Gooseneck Base	Black MXW gooseneck base transmitter (without gooseneck microphone)	MXW8
		White MXW gooseneck base transmitter (without gooseneck microphone)	MXW8W
		Gooseneck microphone	see table
		Battery	SB901A
	USB Charger		Varies by region; see table
	Mono Earpiece/Volume Control		DH 6125+VC
	Anti-Roll Ring for MXW2		A1K

* For MXW2 built after 12/2020

Lavalier Options

Microphone Description	Part Number
Microflex [®] 5mm Subminiature Lavalier, Omnidirectional, Black	MX150B/O-TQG
Microflex [®] 5mm Subminiature Lavalier, Cardioid, Black	MX150B/C-TQG
Microflex [®] Omnidirectional Subminiature Earset, Black	MX153B/O-TQG
Microflex [®] Omnidirectional Subminiature Earset, Tan	MX153T/O-TQG
Microflex [®] Omnidirectional Subminiature Earset, Cocoa	MX153C/O-TQG
Microflex [®] 1cm Omnidirectional Lavalier, Black	WL183
Microflex [®] 1cm Supercardioid Lavalier, Black	WL184
Microflex [®] 1cm Cardioid Lavalier, Black	WL185
Omnidirectional Condenser Miniature Lavalier, Black	WL93

Gooseneck Options

Microphone Description	Polar Pattern	Length	Part Number
Bi-color LED status indicator	Cardioid	5" (12.7 cm)	MX405LP/C
	Supercardioid	5" (12.7 cm)	MX405LP/S
	Mini-shotgun	5" (12.7 cm)	MX405LP/MS
	Cardioid	10" (25.4 cm)	MX410LP/C
	Supercardioid	10" (25.4 cm)	MX410LP/S
	Cardioid	15" (38.1 cm)	MX415LP/C
	Supercardioid	15" (38.1 cm)	MX415LP/S
Light ring indicator	No cartridge included	5" (12.7 cm)	MX405RLP/N
		10" (25.4 cm)	MX410RLP/N
		15" (38.1 cm)	MX415RLP/N
Capsule only	Cardioid	for any length	R185B, R185W-A
	Supercardioid	for any length	R184B, R184W-A
	Mini-shotgun	5" (12.7 cm)	R189B, R189W-A
White with bi-color status indicator	No cartridge included	5" (12.7 cm)	MX405WLP/N
		10" (25.4 cm)	MX410WLP/N
		15" (38.1 cm)	MX415WLP/N

Microphone Description	Polar Pattern	Length	Part Number
White with light ring indicator	No cartridge included	5" (12.7 cm)	MX405WRLP/N
		10" (25.4 cm)	MX410WRLP/N
		15" (38.1 cm)	MX415WRLP/N
White dualflex with bi-color status indicator	No cartridge included	10" (25.4 cm)	MX410WLPDF/N
		15" (38.1 cm)	MX415WLPDF/N
White dualflex with light ring indicator	No cartridge included	10" (25.4 cm)	MX410WRLPDF/N
		15" (38.1 cm)	MX415WRLPDF/N

IEC Power Cable

Power Cable by Region	Part Number
USA	95B8389
Brazil	95A14336
Argentina	95A14335
Europe	95C8247
UK	95A8713
Japan	95B9021
China	95B9073
Korea	95B9074
Australia	95A9128

USB Charger

USB Charger by Region	Part Number
USA	SBC10-USB-A
UK	SBC10-USBUK-A
Europe	SBC10-USBE-A
Australia	SBC10-USBAZ-A
Japan and Taiwan	SBC10-USBJTW-A
Brazil	SBC10-USBR-A
India	SBC10-USBIN-A

Microflex Wireless Specifications

System

RF Carrier Frequency Range

Band	Region	Frequency Range
Z10	USA , Canada , Mexico	1920– 1930 MHz
Z11	Europe , Asia , Middle-East	1880– 1900 MHz
Z12	Japan	1893– 1906 MHz
Z15	Taiwan	1880– 1895 MHz
Z14	Brazil	1910– 1920 MHz

Audio Frequency Response

65 Hz - 16 kHz

Power Consumption

2.5 W

Maximum Output Power

3.0 W RMS

Preamplifier Output Clipping Level

<1% THD

Signal-to-Noise Ratio

<90 dB A-weighted

Cable Requirements

Cat 5e or higher

Dimensions

61 x 150 x 168 mm

Weight

650 g

Operating Temperature Range

5°C (41°F) - 40°C (104°F)

Transmitters

Gain Adjustment Range

-25 to +15 dB (in 1 dB steps)

Maximum Input Level

Mic gain @ -16 dB

-9 dBV

Headphone Output

3.5 mm (1/8"), dual mono (will drive stereo phones)

Maximum Headphone Output Power

1kHz @ 1% distortion, peak power, @16Ω

17.5 mW

Antenna Type

Internal, Spatial Diversity, Linear Polarization

Antenna Gain

Average	-1.1 dBi
Peak	0.5 dBi

Charge Connector

USB 3.0 Type A

Housing

Molded Plastic

Recommended Storage Temperature Range

0°C (32°F) to 25°C (77°F)

MXW1 Hybrid Bodypack Transmitter

Microphone Connector

4-Pin male mini connector (TA4M), See drawing for details

Input Impedance

@ 1 kHz

>20 kΩ

Internal Microphone

Omnidirectional (20 Hz – 20 kHz)

Battery Life

Standard Density Mode	High Density Mode
Up to 7 hours	Up to 8 hours

Calculated with a new battery. Runtimes vary depending on battery health.

Dimensions

22 mm x 45 mm x 99 mm (0.9 in. x 1.8 in. x 3.9 in.) H x W x D

Weight

85 g (3.0 oz.)

with batteries, without microphone

MXW2 Handheld Transmitter**Microphone Capsule**

SM58, SM86, Beta58, VP68

Configuration

Unbalanced

Input Impedance

@ 1 kHz

>20 kΩ

Battery Life

SB902, Standard Density Mode	SB902, High Density Mode	SB905, Standard Density Mode	SB905, High Density Mode
Up to 15 hours	Up to 16 hours	Up to 23 hours	Up to 29 hours

Calculated with a new battery. Runtimes vary depending on battery health.

Dimensions

226 mm x 51 mm (8.9 in. x 2.0 in.) L x Dia.

including SM58 microphone capsule

Weight

369 g (13 oz.)

with batteries, including SM58 microphone capsule

MXW6 Boundary Transmitter**Microphone Capsule**

MXW6/O	R183B
MXW6/C	R185B

Battery Life

Standard Density Mode	High Density Mode
Up to 7 hours	Up to 8 hours

Calculated with a new battery. Runtimes vary depending on battery health.

Dimensions

23 mm x 44 mm x 114 mm (0.9 in. x 1.75 in. x 4.5 in.) H x W x D

Weight

108 g (3.8 oz.)

with batteries

MXW8 Gooseneck-Base Transmitter**Microphone Connector**

6-pin connector for Shure MX405/10/15

Configuration

Unbalanced

Input Impedance

@ 1 kHz

>20 k Ω **Gooseneck Options**

See accessories list

Battery Life

Standard Density Mode	High Density Mode
Up to 7 hours	Up to 8 hours

Calculated with a new battery. Runtimes vary depending on battery health.

Dimensions

36 mm x 71 mm x 124 mm (1.4 in. x 2.8 in. x 4.9 in.) H x W x D

Weight

193 g (6.8 oz.)

with batteries, without microphone

Access Point Transceiver (APT)**Network Interface**

RJ45: Gigabit Ethernet, Dante digital audio

Plenum Rating

UL 2043

Power Requirement

Power over Ethernet (PoE) Class 0, 6.5W

Antenna Type

Internal, Spatial Diversity, Circular Polarization

Antenna Gain

Average	0.5 dBi
Peak	3.0 dBi

Housing

Molded Plastic, Cast Zinc

Dimensions

24 mm x 170 mm x 170 mm (1.35 in. x 6.7 in. x 6.7 in.), H x W x D

Without mounting plate or cover

Weight

APT8	856 g (1.9 lbs)
APT2, APT4	845 g (1.9 lbs)
Paintable Cover	85 g (0.2 lbs)
Mounting Bracket	68 g (0.15 lbs)

Networked Charging Station (NCS)

Charge Time

MXW1, MXW6, MXW8		50%=1 hour; 100%=2 hours; High Efficiency Mode=4-5 hours
MXW2	SB902	50%=1.5 hour; 100%=3 hours; High Efficiency Mode=4-5 hours
	SB905	50%=2.5 hour; 100%=5 hours; High Efficiency Mode=5-6 hours

Network Interface

10/100 Mbps Ethernet

Power Requirement

15 V DC @ 3.33 A maximum, supplied by external power supply (tip positive)

Housing

Molded Plastic, Cast Zinc

Dimensions

NCS8	68 mm x 343 mm x 184 mm (2.7 in. x 13.5 in. x 7.25 in.), H x W x D
NCS4	68 mm x 191 mm x 184 mm (2.7 in. x 7.5 in. x 7.25 in.), H x W x D
NCS2	48 mm x 102 mm x 154 mm (1.9 in. x 4.0 in. x 6.1 in.), H x W x D

Weight

NCS8	2.9 kg (6.4 lbs)
NCS4	1.7 kg (3.7 lbs)

NCS2	0.8 kg (1.8 lbs)
-------------	------------------

Audio Network Interface (ANI)

Audio Network Interface (ANI)

Audio Frequency Response

20 Hz to 20 kHz (+1, -1.5 dB)

Dynamic Range

20 Hz to 20 kHz, A-weighted, typical

Analog-to-Dante	113 dB
Dante-to-Analog	110 dB

Output Noise

20 Hz to 20 kHz, A-Weighted, typical

Line	Aux	Mic
-84.5 dBV	-95.2 dBV	-106.5 dBV

THD+N

20 Hz to 20 kHz+4dBu analog input, -10 dBFS digital input

<0.05%

Polarity

Non-inverting, any input to any output

Dimensions

44 mm x 483 mm x 366 mm (1.7 in. x 19.0 in. x 14.4 in.), H x W x D

Weight

MXWANI4	3.1 kg (6.9 lbs)
MXWANI8	3.2 kg (7.1 lbs)

Housing

Steel; Extruded aluminum

Power Requirements

100 to 240 V AC, 50-60 Hz, 1 A

Operating Temperature Range

-18°C (0°F) to 63°C (145°F)

Storage Temperature Range

-29°C (-20°F) to 74°C (165°F)

Analog Connections

Outputs

Configuration	Impedance	Clipping Level (minimum)		
		Line	Aux	Mic
Active Balanced	310 Ω	+26.2 dBV	+16.2 dBV	-3.8 dBV

Input(s)

Configuration	Impedance	Clipping Level (minimum)	
		Line	Aux
Active Balanced	10.6 k Ω	+23.8 dBV	+10.8 dBV

Headphone Output

6.35 mm (1/4") TRS, 100 mW, 350 Ω , dual mono (will drive stereo phones)

0 dBV = 1 V RMS; 0 dBu = 0.775 V RMS; 0 dBV = 2.2 dBu

Digital Signal Processing

AD/DA Converter

24-bit, 48 kHz

Latency

Estimated Nominal, ± 0.1 ms

Analog-to-Dante	0.21 ms
Dante-to-Analog	0.24 ms + T _N

T_N = Network latency in milliseconds, as set in Dante Controller.

Note: Dante network latency is typically associated with the receiving device.

Networking

Network Interface

Four-Port Gigabit Ethernet Switch, Dante digital audio

Uplink Port (Port 4)

Selectable, blocks multicast traffic

Power over Ethernet (PoE)

Provided on Port 1 to power MXWAPT

Cable Requirements

Cat 5e or higher, shielded, 100 m maximum between network devices

Network Addressing Capability

DHCP, link-local, static

Transmitter Output Power

Bands: Z10, Z11, Z14, Z15

MXW1

Setting	dBm	mW
Low	-2	1
Medium	5	3
High	12	16
Maximum	17	50

MXW2

Setting	dBm	mW
Low	0	1
Medium	7	5
High	12	16
Maximum	17	50

MXW6, MXW8

Setting	dBm	mW
Low	-2	1
Medium	5	3
High	12	16
Maximum	19	80

Band: Z12

MXW1, MXW6, MXW8

Setting	dBm	mW
Low	0	1
Medium	5	3
High	9	8
Maximum	12	16

MXW2

Setting	dBm	mW
Low	0	1
Medium	7	5
High	9	8
Maximum	12	16

Wiring Diagram

TA4M Connector

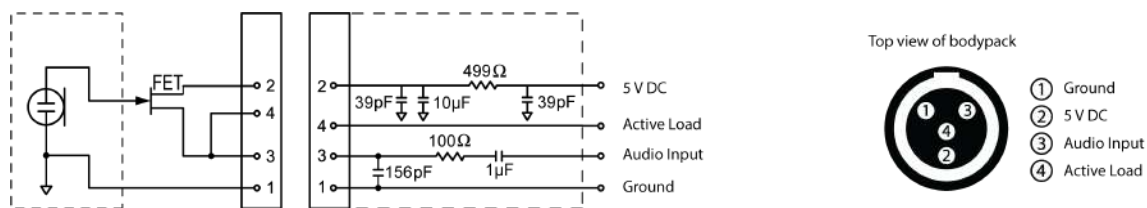

Top view of bodypack



Audio Network Interface (ANI)

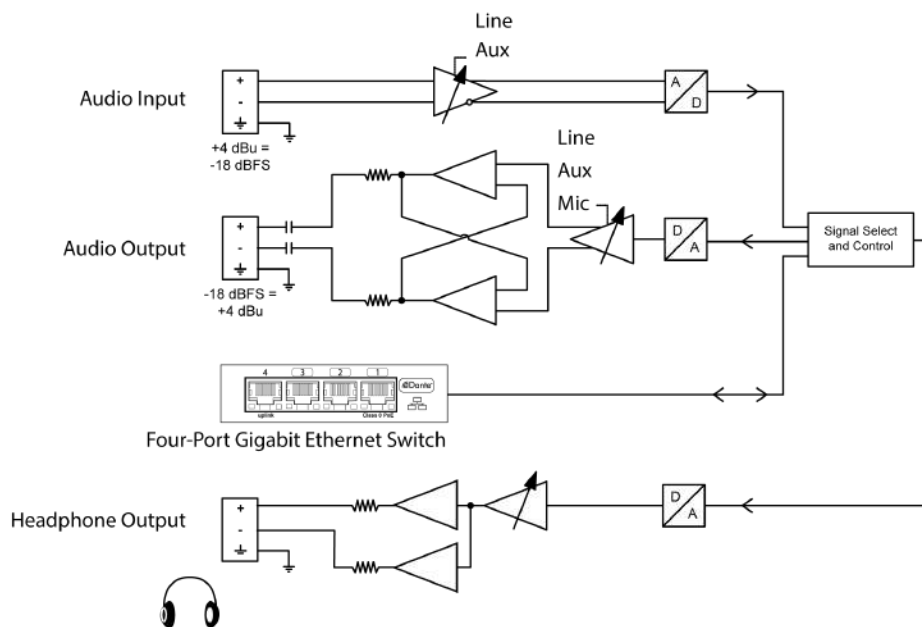



Important Safety Instructions

1. READ these instructions.
2. KEEP these instructions.
3. HEED all warnings.
4. FOLLOW all instructions.
5. DO NOT use this apparatus near water.
6. CLEAN ONLY with dry cloth.
7. DO NOT block any ventilation openings. Allow sufficient distances for adequate ventilation and install in accordance with the manufacturer's instructions.
8. DO NOT install near any heat sources such as open flames, radiators, heat registers, stoves, or other apparatus (including amplifiers) that produce heat. Do not place any open flame sources on the product.
9. DO NOT defeat the safety purpose of the polarized or grounding type plug. A polarized plug has two blades with one wider than the other. A grounding type plug has two blades and a third grounding prong. The wider blade or the third prong are provided for your safety. If the provided plug does not fit into your outlet, consult an electrician for replacement of the obsolete outlet.
10. PROTECT the power cord from being walked on or pinched, particularly at plugs, convenience receptacles, and the point where they exit from the apparatus.
11. ONLY USE attachments/accessories specified by the manufacturer.
12. USE only with a cart, stand, tripod, bracket, or table specified by the manufacturer, or sold with the apparatus. When a cart is used, use caution when moving the cart/apparatus combination to avoid injury from tip-over.



13. UNPLUG this apparatus during lightning storms or when unused for long periods of time.
14. REFER all servicing to qualified service personnel. Servicing is required when the apparatus has been damaged in any way, such as power supply cord or plug is damaged, liquid has been spilled or objects have fallen into the apparatus, the apparatus has been exposed to rain or moisture, does not operate normally, or has been dropped.
15. DO NOT expose the apparatus to dripping and splashing. DO NOT put objects filled with liquids, such as vases, on the apparatus.
16. The MAINS plug or an appliance coupler shall remain readily operable.
17. The airborne noise of the Apparatus does not exceed 70dB (A).
18. Apparatus with CLASS I construction shall be connected to a MAINS socket outlet with a protective earthing connection.
19. To reduce the risk of fire or electric shock, do not expose this apparatus to rain or moisture.
20. Do not attempt to modify this product. Doing so could result in personal injury and/or product failure.
21. Operate this product within its specified operating temperature range.
22. Follow local regulations and consult qualified personnel if the product installation or relocation requires construction work. Choose mounting hardware and an installation location that can support the weight of the product. Avoid locations subject to constant vibration. Use the required tools to install the product properly. Inspect the product periodically.

	This symbol indicates that dangerous voltage constituting a risk of electric shock is present within this unit.
	This symbol indicates that there are important operating and maintenance instructions in the literature accompanying this unit.

WARNING:

LISTENING TO AUDIO AT EXCESSIVE VOLUMES CAN CAUSE PERMANENT HEARING DAMAGE. USE AS LOW A VOLUME AS POSSIBLE. Over exposure to excessive sound levels can damage your ears resulting in permanent noise-induced hearing loss (NIHL). Please use the following guidelines established by the Occupational Safety Health Administration (OSHA) on maximum time exposure to sound pressure levels before hearing damage occurs.

90 dB SPL at 8 hours	95 dB SPL at 4 hours	100 dB SPL at 2 hours	105 dB SPL at 1 hour
110 dB SPL at ½ hour	115 dB SPL at 15 minutes	120 dB SPL Avoid or damage may occur	

Safety Information for Batteries

1. Battery packs may explode or release toxic materials. Risk of fire or burns. Do not open, crush, modify, disassemble, heat above 140°F (60°C), or incinerate.
2. Follow instructions from manufacturer
3. Only use Shure charger to recharge Shure rechargeable batteries

WARNING:

Danger of explosion if battery incorrectly replaced. Replace only with same or equivalent type.

Do not dispose of the battery along with household waste. Check with local vendor for proper disposal of used battery packs.

4. Never put batteries in mouth. If swallowed, contact your physician or local poison control center
5. In the event of a cell leaking, do not allow the liquid to come in contact with the skin or eyes. If contact has been made, wash the affected area with copious amounts of water and seek medical advice.
6. Do not short circuit; may cause burns or catch fire
7. Do not charge or use battery packs other than Shure rechargeable batteries
8. Batteries (battery pack or batteries installed) shall not be exposed to excessive heat such as sunshine, fire or the like
9. Do not immerse the battery in liquid such as water, beverages, or other fluids.
10. Do not attach or insert battery with polarity reversed.
11. Keep away from small children.
12. Do not use abnormal batteries.
13. Pack the battery securely for transport.

Note: Use only with the included power supply, batteries, or a Shure-approved equivalent.

Storing Batteries

If batteries are to be stored for more than eight days, they should be placed into a temperature controlled storage area. Recommended battery storage temperature is 10 to 25°C (50 to 77°F).

Important Product Information

The equipment is intended to be used in professional audio applications.

EMC conformance testing is based on the use of supplied and recommended cable types. The use of other cable types may degrade EMC performance.

Changes or modifications not expressly approved by Shure Incorporated could void your authority to operate this equipment.

Please follow your regional recycling scheme for batteries, packaging, and electronic waste.

Note: This device is not intended to be connected directly to a public internet network.

Information to the user

This equipment has been tested and found to comply with the limits for a Class B digital device, pursuant to part 15 of the FCC Rules. This equipment generates, uses, and can radiate radio frequency energy and, if not installed and used in accordance with the manufacturer's instruction manual, may cause interference with radio and television reception.

Notice: The FCC regulations provide that changes or modifications not expressly approved by Shure Incorporated could void your authority to operate this equipment.

These limits are designed to provide reasonable protection against harmful interference in a residential installation. This equipment generates, uses, and can radiate radio frequency energy and, if not installed and used in accordance with the instructions, may cause harmful interference to radio communications. However, there is no guarantee that interference will not occur in a particular installation. If this equipment does cause harmful interference to radio or television reception, which can be determined by turning the equipment off and on, the user is encouraged to try to correct the interference by one or more of the following measures:

- Reorient or relocate the receiving antenna.
- Increase the separation between the equipment and the receiver.
- Connect the equipment to an outlet on a circuit different from that to which the receiver is connected.
- Consult the dealer or an experienced radio/TV technician for help.

This device complies with part 15 of the FCC Rules. Operation is subject to the following two conditions:

1. This device may not cause harmful interference.
 2. This device must accept any interference received, including interference that may cause undesired operation.
1. 經審驗合格之射頻電信終端設備，非經許可，公司、商號或使用者均不得擅自變更頻率、加大功率或變更原設計之特性及功能。
 2. 射頻電信終端設備之使用不得影響飛航安全及干擾合法通信；經發現有干擾現象時，應立即停用，並改善至無干擾時方得繼續使用。所謂合法通信，係指依電信法規定作業之無線電信。
 3. 輸入、製造射頻電信終端設備之公司、商號或其使用者違反本辦法規定，擅自使用或變更無線電頻率、電功率者，除依電信法規定處罰外，國家通訊傳播委員會並得撤銷其審驗合格證明。
 4. 減少電磁波影響，請妥適使用

Bodypack Microphone Transmitters

These transmitters have been tested and found to comply with international radiation exposure limits set forth for an uncontrolled environment. This equipment is in direct contact with the body of the user under normal operating conditions. These transmitters must not be co-located or operating in conjunction with any other antenna or transmitter.

Handheld Microphone Transmitters

Tabletop Boundary Microphone Transmitters

Tabletop Gooseneck Microphone Transmitters

Wireless Access Point Transmitters

These mobile transmitters are intended for use at distances greater than 20 centimeters from the human body. These mobile transmitters are exempt from the testing requirements of international radiation exposure standards due to their proximity to the

body of the user in their intended use case and their low power output. These mobile transmitters shall be placed or installed at least 20 cm from any person and must not be co-located or operating in conjunction with any other antenna or transmitter.

Certifications

This device complies with FCC Part 15.

Industry Canada (IC) Notices

This device contains licence-exempt transmitter(s)/receiver(s) that comply with Innovation, Science and Economic Development Canada's licence-exempt RSS(s). Operation is subject to the following two conditions:

1. This device may not cause interference.
2. This device must accept any interference, including interference that may cause undesired operation of the device.

L'émetteur/récepteur exempt de licence contenu dans le présent appareil est conforme aux CNR d'Innovation, Sciences et Développement économique Canada applicables aux appareils radio exempts de licence. L'exploitation est autorisée aux deux conditions suivantes :

1. L'appareil ne doit pas produire de brouillage;
2. L'appareil doit accepter tout brouillage radioélectrique subi, même si le brouillage est susceptible d'en compromettre le fonctionnement.

Japanese Radio Law and Japanese Telecommunications Business Law Compliance. This device is granted pursuant to the Japanese Radio Law (電波法) and the Japanese Telecommunications Business Law (電気通信事業法). This device should not be modified (otherwise the granted designation number will become invalid).

Conforms to electrical safety requirements based on IEC 60065.

This product meets the Essential Requirements of all relevant European directives and is eligible for CE marking.

The CE Declaration of Conformity can be obtained from Shure Incorporated or any of its European representatives. For contact information please visit www.shure.com

The CE Declaration of Conformity can be obtained from: www.shure.com/europe/compliance

Authorized European representative:

Shure Europe GmbH
Global Compliance
Jakob-Dieffenbacher-Str. 12
75031 Eppingen, Germany
Phone: +49-7262-92 49 0
Email: info@shure.de
www.shure.com

Authorized under the FCC verification provision per Part 15b.

Industry Canada ICES-003 Compliance Label: CAN ICES-3 (B)/NMB-3(B)

Note: See the label located on the bottom side of the charger enclosure for the FCC marking, the CE marking, the RCM marking, and the electrical ratings.

設備名稱：網絡充電座 Equipment name		型號（型式）：MXWNCS2, MXWNCS4, MXWNCS8 Type designation (Type)				
單元/Unit	受限制物質及其化學符號 Restricted substances and its chemical symbols					
	鉛(Lead) (Pb)	汞(Mercury) (Hg)	鎘(Cadmium) (Cd)	六價鉻 (Hexavalent chromium (Cr ⁶⁺))	多溴聯苯 Polybrominated biphenyls (PBB)	多溴二苯醚 Polybrominated diphenyl ethers (PBDE)
電路板	—	○	○	○	○	○
電子零件	—	○	○	○	○	○
金屬件	—	○	○	○	○	○
塑膠件	○	○	○	○	○	○
電源供應器	—	○	○	○	○	○

備考1. "超出0.1 wt %" 及 "超出0.01 wt %" 係指該項物質之百分比含量超出百分比含量基準值。
 Note 1. "Exceeding 0.1 wt %" and "exceeding 0.01 wt %" indicate that the percentage content of the restricted substance exceeds the reference percentage value of previous condition.

備考2. "○" 係指該項受限制物質之百分比含量未超出百分比含量基準值。
 Note 2. "○" indicates that the percentage content of the restricted substance does not exceed the percentage of reference value of previous condition.

備考3. "—" 係指該項受限制物質為排除項目。
 Note 3. The "-" indicates that the restricted substance is exempted in the equipment.

Certified under FCC Part 15.

FCC: DD4MXW1, DD4MXW2, DD4MXW6, DD4MXW8, DD4MXWAPT4, DD4MXWAPT8.

Meets applicable requirements of RSS-213.

IC: 616A-MXW1, 616A-MXW2, 616A-MXW6, 616A-MXW8, 616A-MXWAPT4, 616A-MXWAPT8.

Trademarks

Audinate[®], the Audinate logo and Dante[®] are trademarks of Audinate Pty Ltd.