



MX412,, MX418,, MX424

Gooseneck Microphones

Online user guide for Shure Microflex MX400 Series miniature gooseneck-mounted electret condenser microphones.
Version: 5.1 (2021-C)

Table of Contents

MX412, MX418, MX424 Gooseneck Microphones	3	Microphone Placement	5
General Description	3	Permanent Installation	5
Interchangeable Cartridges	3	Flange	5
Snap-Fit Windscreen	5	Shock Mount	6
Preamp Gain	5	Specifications	7
		Certifications	12

MX412, MX418, MX424 Gooseneck Microphones

General Description

The Shure Microflex[®] MX412, MX418, and MX424 microphones are miniature gooseneck-mounted electret condenser microphones designed primarily for speech and vocal pickup. They can be mounted on lecterns, pulpits, or conference tables. All models include a preamplifier and are available with interchangeable cartridges.

- Wide dynamic range and frequency response for accurate sound reproduction
- Interchangeable cartridges that provide an optimal polar pattern choice for each application
- Shock mount provides over 20 dB of isolation from surface vibration noise
- Snap-fit foam windscreen reduces breath noise or plosives
- CommShield[®] RF filtering reduces interference from nearby mobile devices

These microphones are available with 12 inch, 18 inch, or 24 inch goosenecks. Some models are also available with a built-in mute switch.

- "S" models include a mute button and LED.
- "D" models include a desktop base with programmable mute button and LED and logic input and output.
- "SE" models feature a surface mount flange with side-exit cable.

The polar pattern of the included cartridge is indicated by a model number suffix:

/C Cardioid

/S Supercardioid

/MS Mini-shotgun

/O Omnidirectional

/N Cartridge not included

Interchangeable Cartridges

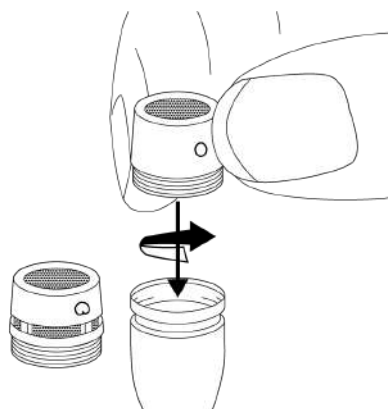

Microflex microphones use interchangeable cartridges that allow you to choose the polar pattern for different installations.

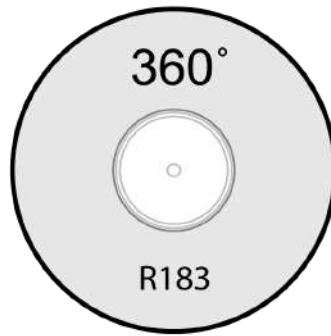

Omnidirectional

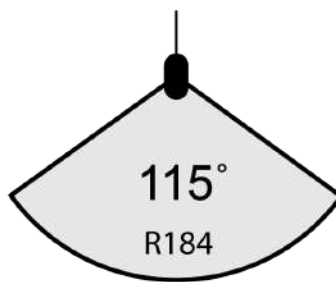

Supercardioid

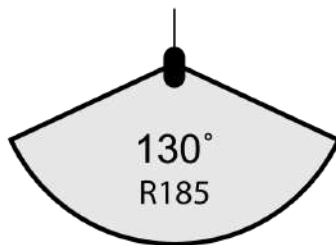

Cardioid

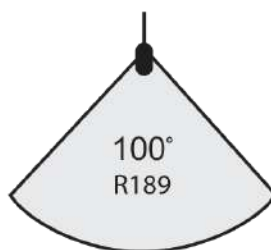

Mini-shotgun

Snap-Fit Windscreen

- Snap into the groove below the cartridge.
- To remove, spread the gap with a screwdriver or thumbnail.
- Provides 30 dB of "pop" protection.

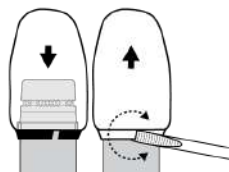

Preamp Gain

If necessary, the preamplifier gain can be reduced by 12 dB. Contact an authorized Shure service center for information.

Microphone Placement

- Aim the microphone toward the desired source, such as the talker.
- Aim it away from any unwanted source, such as a loudspeaker.
- Place the tip of the microphone within 15 to 30 cm (6 to 12 inches) of the desired sound source.
- Always use the supplied windscreen or optional metal windscreen to control breath noise.
- If four or more microphones will be open at the same time, use of an automatic mixer is recommended.

Permanent Installation

Mount the microphone using one of the following methods.

Flange

1. Drill a 22 mm (7/8 in.) diameter hole in the desired location.
2. Trace and drill three starter holes for the supplied screws using the flange as a template.
3. Insert the preamplifier through the mounting flange.
4. Slip the mounting flange retaining ring over the bottom of the preamplifier and slide it up until it is flush to the bottom of the flange. Then press the ring firmly into place.
5. Secure the flange to the mounting surface with three screws.

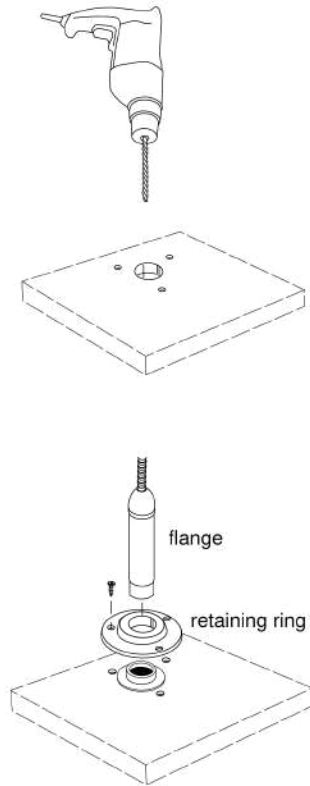

Shock Mount

1. Drill a 44 mm (1-3/4 in.) diameter hole in desired mounting surface.
2. Mark and drill starter holes for screws, using shock mount as a template.
3. Secure shock mount to mounting surface with screws.
4. Thread the supplied adapter onto the microphone before inserting it into the shock mount.

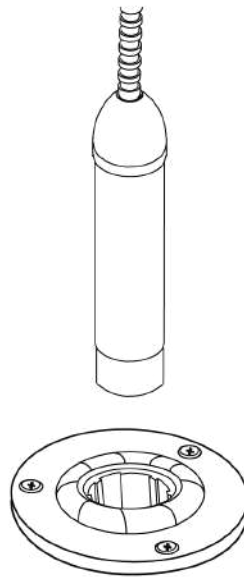
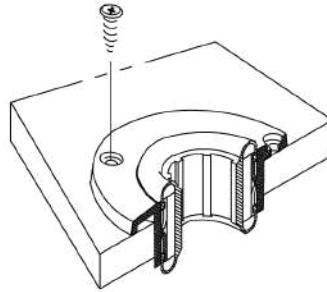

Specifications

Type

Electret Condenser

Frequency Response

50–17000 Hz

Polar Pattern

MX412/C, MX418/C, MX424/C	Cardioid
MX412/S, MX418/S, MX424/S	Supercardioid

Output Impedance

180 Ω

Output Configuration

Active Balanced

Sensitivity

@ 1 kHz, open circuit voltage

Cardioid	-35 dBV/Pa(18 mV)
Supercardioid	-34 dBV/Pa(21 mV)

Maximum SPL

1 kHz at 1% THD, 1 kΩ load

Cardioid	124 dB
Supercardioid	123 dB

Self Noise

A-weighted

Cardioid	28 dB SPL
Supercardioid	27 dB SPL

Signal-to-Noise Ratio

Ref. 94 dB SPL at 1 kHz

Cardioid	66 dB
Supercardioid	68 dB

Dynamic Range

1 kΩ load, @ 1 kHz

96 dB

Common Mode Rejection

10 Hz to 100 kHz

45 dB, minimum

Clipping Level

at 1% THD

-6 dBV (0.5 V)

Polarity

Positive sound pressure on diaphragm produces positive voltage on pin 2 relative to pin 3 of output XLR connector

Mute Switch

MX412S/MX418S

-50 dB minimum

Environmental Conditions

Operating Temperature	-18–57°C (0–135°F)
Storage Temperature	-29–74°C (-20–165°F)
Relative Humidity	0–95%

Power Requirements

11–52 V DC, 2.0 mA

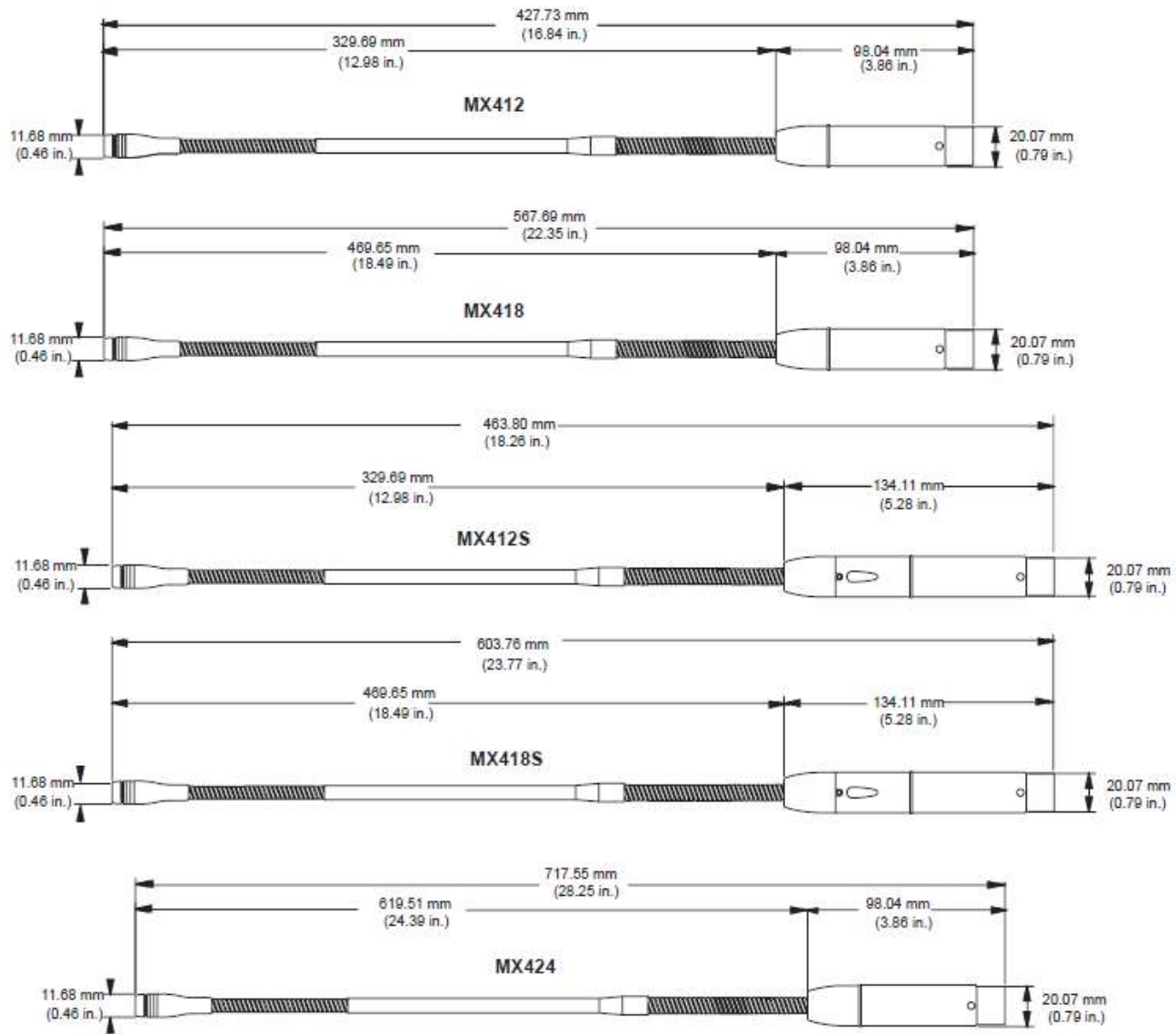

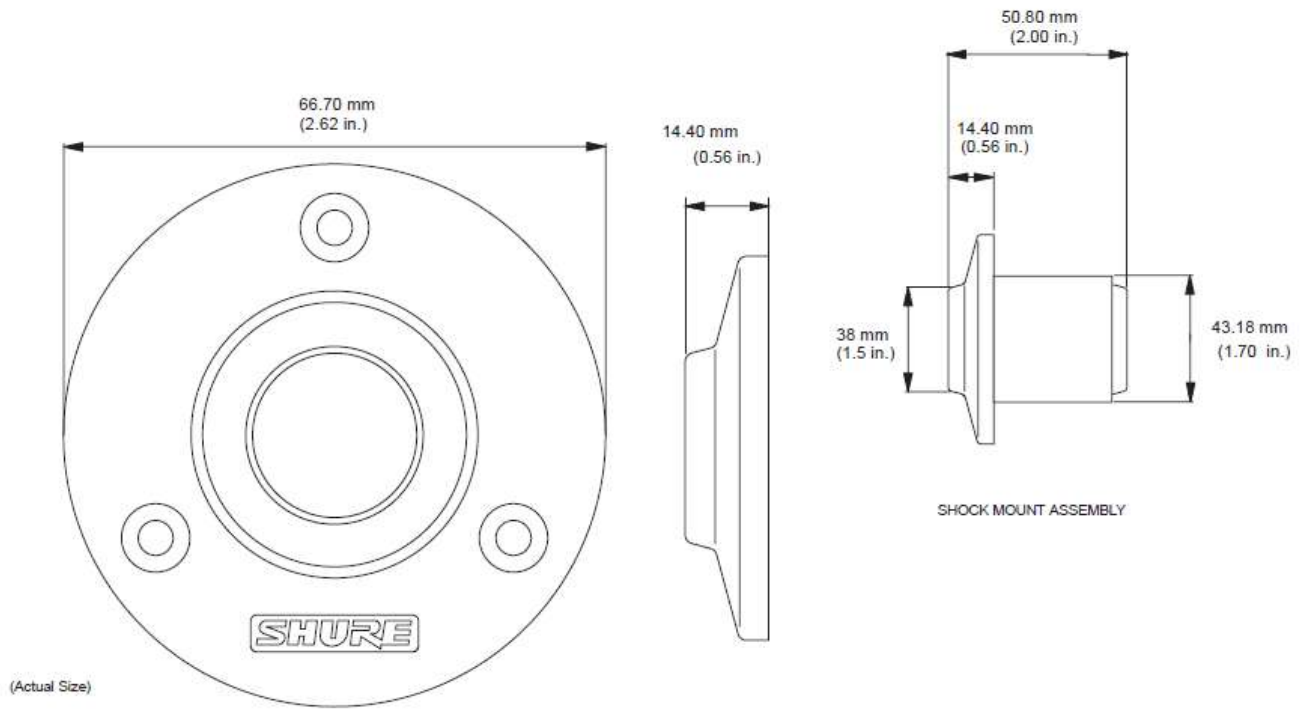

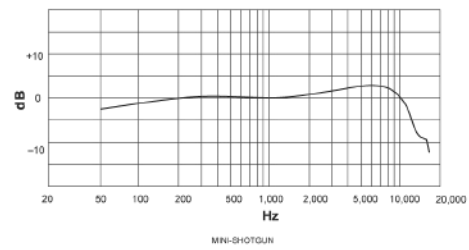
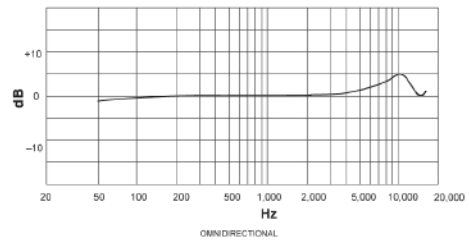
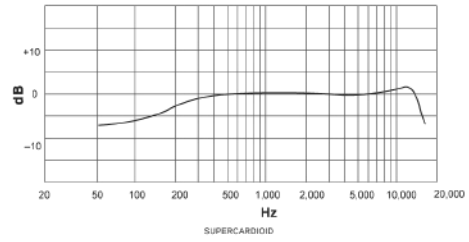
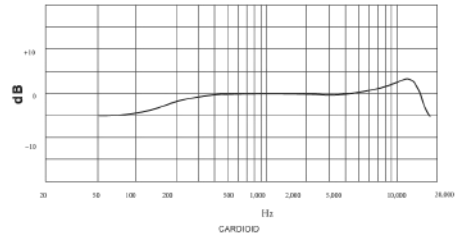

TYPICAL FREQUENCY RESPONSE

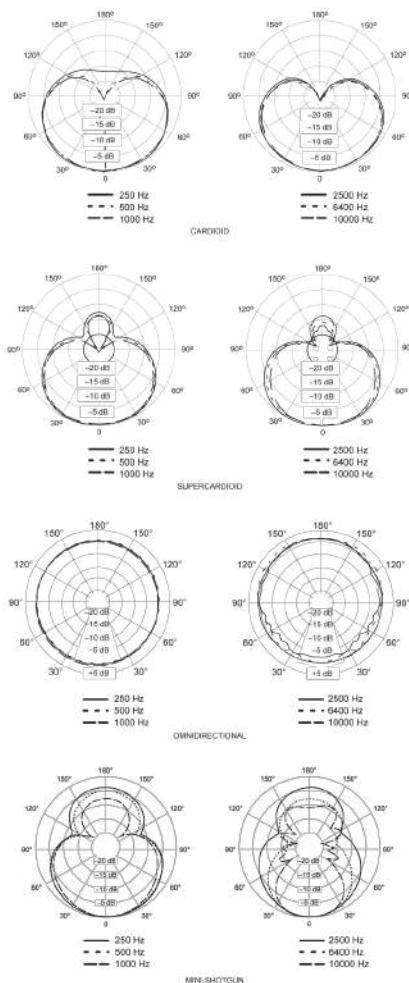

Certifications

Meets essential requirements of all applicable European Directives.

Eligible for CE marking.

The CE Declaration of Conformity can be obtained from Shure Incorporated or any of its European representatives. For contact information please visit www.shure.com

The CE Declaration of Conformity can be obtained from: www.shure.com/europe/compliance

Authorized European representative:

Shure Europe GmbH

Global Compliance

Jakob-Dieffenbacher-Str. 12

75031 Eppingen, Germany

Phone: +49-7262-92 49 0

Email: info@shure.de

www.shure.com