

* All screen images simulated for illustrative purposes only.

55VSH7J-H

0.44mm Even Bezel Video Wall

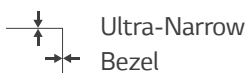

Ultra-Narrow
Bezel



Wide
Viewing Angle



Easy Color
Adjustment



Efficient
Operation

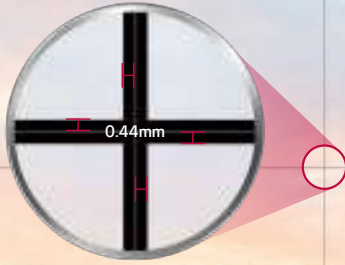

* All screen images simulated for illustrative purposes only.

Ultra-Narrow 0.44mm Even Bezel

The 0.44 mm bezel of the VSH7J-H series produces an incredibly narrow 0.88 mm bezel-to-bezel gap that helps content look like the actual original image by depicting a content true to form. Assembled into a large video wall screen, this series will provide an immersive experience to viewers.

VIVID AND DYNAMIC PICTURE QUALITY



* All screen images simulated for illustrative purposes only.

60° High Viewing Angle*

Higher Viewing Angle

Large screens are usually positioned higher than human-eye level, making uniform picture quality essential for video walls. The viewing angle of the VSH7J-H series is high enough to display vivid colors clearly throughout the screen.



* All screen images simulated for illustrative purposes only.

Wide Viewing Angle

It is well known that LG IPS panel technology enables sharp control of liquid crystals, which in turn allows the screen to be viewed from virtually any angle. Because of this, the VSH7J-H series captures the attention of and captivates viewers with lifelike colors, virtually regardless of their viewing position.

* Results based on in-house testing. Actual test results may differ depending on environment and measuring equipment.

VIVID AND DYNAMIC PICTURE QUALITY



* All screen images simulated for illustrative purposes only.

Uniform Color Expression

Poor uniformity around bezel boundaries can give the corners a darker appearance, which doesn't look good on a large screen. However, the VSH7J-H series has enhanced uniformity, even within the four corners of the display, to deliver vivid and consistent color throughout the screen.

* Uniformity among 13 points of the screen based on in-house testing.
Test results may differ depending on environment and measuring equipment.



* All screen images simulated for illustrative purposes only.

Image Gap Reduction

The VSH7J-H series includes an image improvement algorithm that can reduce image gaps among tiled displays when playing back videos. Objects located on the bezel boundaries are adjusted for a virtually seamless viewing experience.

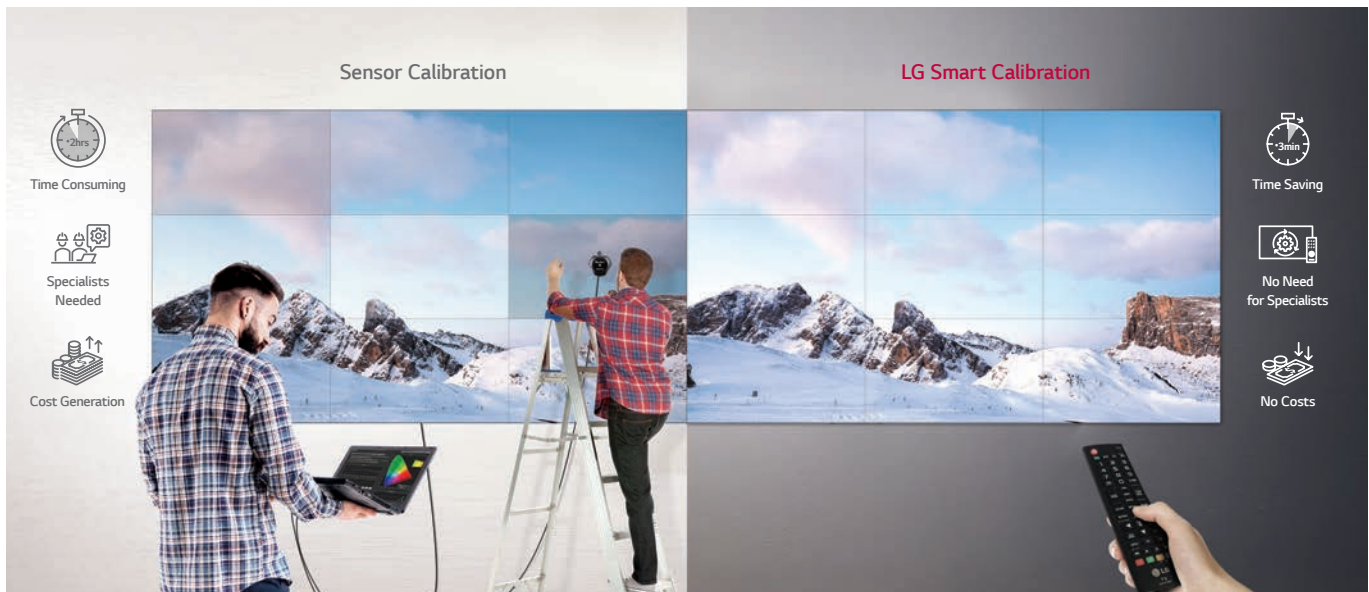

* All screen images simulated for illustrative purposes only.

Smart Calibration

Smart calibration was created to help ensure backlight uniformity using internal sensors within the panel. With just few simple clicks of a remote control, this calibration process can be done in a matter of minutes. In addition, calibration can be set to automatically occur at regular intervals to always deliver optimum image quality.

VIVID AND DYNAMIC PICTURE QUALITY



* All screen images simulated for illustrative purposes only.

Clear View with Non-glare Panel

Viewers can be annoyed by unnecessary light reflection when watching a screen under bright conditions. The VSH7J-H series has addressed such inconveniences by increasing the level of haze to 28% which enhances visibility and text readability.

POWERFUL SMART SIGNAGE PLATFORM



* All screen images simulated for illustrative purposes only.

High Performance and Great Scalability

Thanks to its built-in system-on-chip and webOS smart signage platform, VSH7J-H series can execute several tasks at once while providing smooth content playback without the need for a media player. As webOS supports HTML5 as a web-based platform and offers a software development kit (SDK), it is even easier for system integrators to build and optimize their web apps. The SDK can be downloaded free from

<https://webossignage.developer.lge.com>.

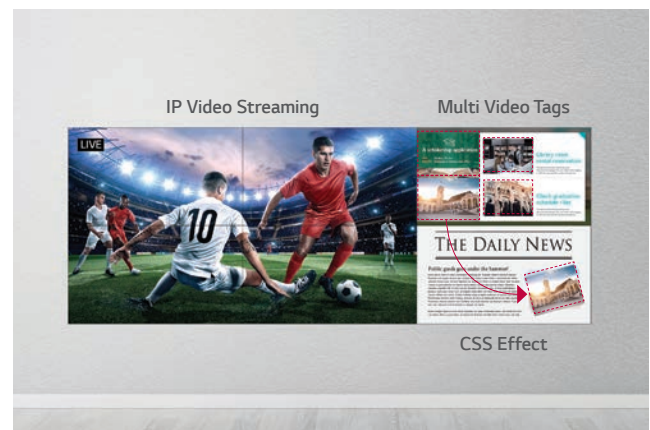

* All screen images simulated for illustrative purposes only.

Flexible Content Creation

Four different videos can be played simultaneously via web apps. Various animation effects, such as scaling or rotating, are added to content using CSS (Cascading Style Sheets) transition effects. Real-time streaming* is also available, providing the flexibility to organize and diversify content free from local capacity limits.

* Supported protocols: RTSP, RTP, HLS, UDP Multicast

USER-FRIENDLY SMART SIGNAGE UX



* All screen images simulated for illustrative purposes only.

Intuitive Menu Structure

The menu structure of the VSH7J-H series has been optimized for commercial use by simplifying menus and grouping similar functions together. This intuitive user interface can help users avoid having to do trial-and-error when exploring desired functions and managing displays.

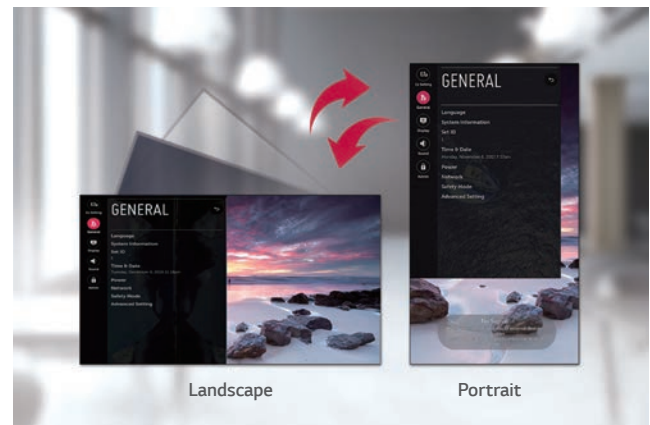

* All screen images simulated for illustrative purposes only.

Dedicated GUI for Portrait Orientation

The onscreen display of the VSH7J-H series consists of a menu with bigger font sizes and a 9:16 aspect ratio, creating a comfortable and efficient business environment.

USER CONVENIENCE

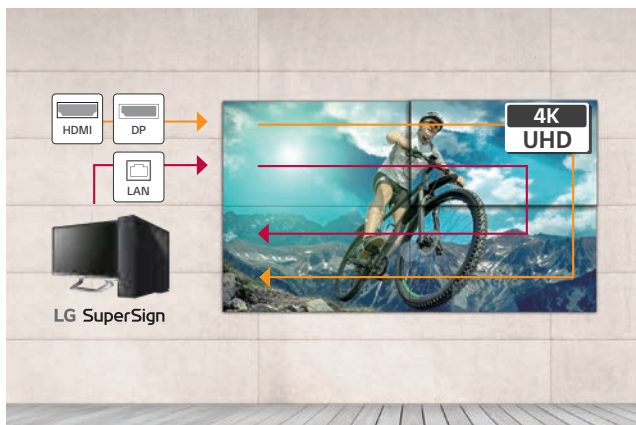

* All screen images simulated for illustrative purposes only.

Daisy Chain Capability

A LAN daisy chain allows you to control and monitor video walls and even update the firmware in all screens of the video wall at once. Also, through UHD daisy chain using HDMI and DisplayPort, you can easily set up a UHD video wall without the need of DisplayPort MST or Matrox graphics card.



* All screen images simulated for illustrative purposes only.

Real-Time LG ConnectedCare

Maintenance is easy and fast with the optional LG ConnectedCare service, a cloud service subscription provided by LG that is available for purchase separately. It allows remote management of display status in client workplaces for fault diagnosis and remote-control services.

PRODUCT INFORMATION



VSH7J-H

Screen Size	55"
Aspect Ratio	16:9
Native Resolution	FHD (1920 × 1080)
Brightness (Typ.)	700 nits
Contrast Ratio	1100 :1

DIMENSIONS

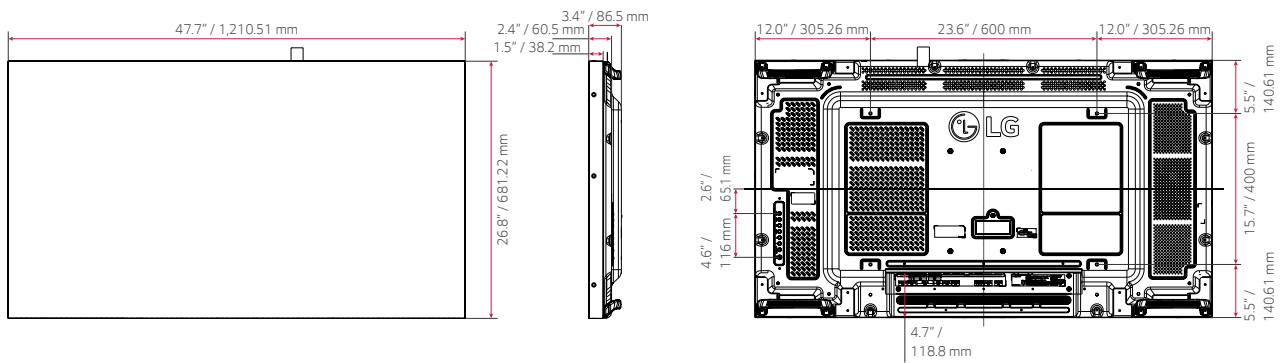

CONNECTIVITY

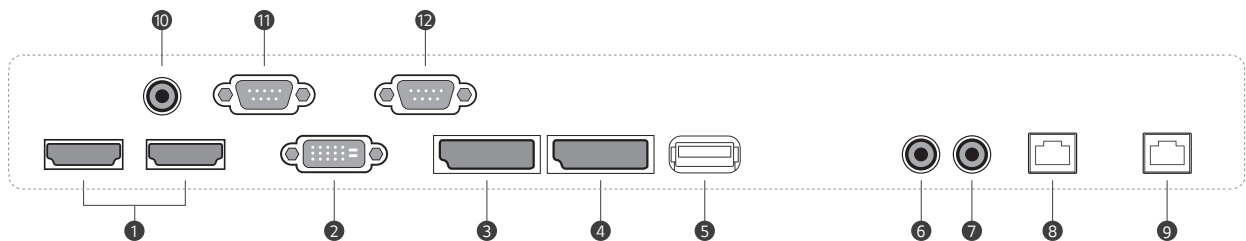

1 HDMI IN

2 DVI-D IN

3 DP IN

4 DP OUT

5 USB 2.0 IN

6 AUDIO IN

7 AUDIO OUT

8 LAN IN

9 LAN OUT

10 IR IN

11 RS-232C IN

12 RS-232C OUT

MODEL NAME	55VSH7J-H	
DISPLAY	Screen Size	55"
	Panel Technology	IPS
	Back Light Type	Direct
	Aspect Ratio	16:9
	Native Resolution	1920 x 1080
	Refresh Rate	60 Hz
	Brightness (Typ.)	700 nits
	Contrast Ratio	1100:1
	Dynamic Contrast Ratio	500,000:1
	Color gamut	NTSC 72%
	Viewing Angle (H x V)	178° x 178°
	Color Depth	10bit, 1.07Billion colors
	Response Time (G to G)	8 ms
	Surface Treatment (Haze)	28%
	SOUND	Lifetime (Typ.)
Operation Hours (Hours/Day)		24/7
CONNECTIVITY	Portrait / Landscape	Yes / Yes
	Speaker	No
	HDMI	Yes (x2), HDCP2.2
	DP	Yes, HDCP2.2
	DVI-D	Yes, HDCP1.4
	Audio In	Yes
	RS232C IN	Yes
	RJ45(LAN)	Yes
	IR IN	Yes
	USB	Yes, USB2.0 Type A
	DP Out	Yes
	Audio Out	Yes
	RS232C OUT	Yes
	RJ45(LAN)	Yes
	MECHANICAL	Bezel Color
Bezel Width		0.44 mm even bezel
Weight		40.6 lbs. / 18.4 kg
Packed Weight		52.0 lbs. / 23.6 kg
Monitor Dimensions (W x H x D)		47.7 x 26.8 x 3.4 in. 1210.51 x 681.22 x 86.5mm
Shipping Dimensions (W x H x D)		53.3 x 33.7 x 10.4 in. 1353 x 855 x 263 mm
Handle		Yes
IP Rating		IP5X
VESATM Standard Mount Interface		600 x 400
FEATURES		Internal Memory
	Temperature Sensor	Yes
	BLU Sensor	Yes
	Acceleration(Gyro) Sensor	Yes
	Smart Calibration	Yes
	Local Key Operation	Yes
	webOS Signage version	webOS 4.1
	Local Contents Scheduling	Yes
	Group Manager	Yes
	USB Plug & Play	Yes
	Fail over	Yes
	No Signal Image	Yes
RS-232C Sync	Yes	

MODEL NAME	55VSH7J-H	
FEATURES	Local Network Sync	Yes
	Video Tag	Yes (x4)
	Play via URL	Yes
	Screen Rotation	Yes
	External Input Rotation	Yes
	Gapless Playback	Yes
	Tile Mode Setting	Yes (Max. 15x15)
	Setting Data Cloning	Yes
	SNMP	Yes
	ISM Method	Yes
	Auto Set ID	Yes
	Status Mailing	Yes
	Control Manager	Yes
	Crestron Inside	Yes
	Smart Energy Saving	Yes
	PM mode	Yes
	Wake on LAN	Yes
	Network Ready	Yes
	HDMI-CEC	Yes
	SI Server Setting	Yes
webRTC	Yes	
Pro:Idiom	Yes	
W/B Setting by Grey scale	Yes	
Scan Inversion	Yes	
ELECTRICAL	Power Supply	100-240 Vac, 50/60 Hz
	Power Type	Built-In Power
	Typical Power Consumption	210 W
	Max Power Consumption	250 W
	Typical Heat Dissipation	717 BTU/Hr
	Max Heat Dissipation	853 BTU/Hr
	Smart Energy Saving	110 W
	DPM	0.5 W
	Power off	0.5 W
	OPS compatible	Yes (Piggyback)
OPS Power built in	No	
Operation Temperature	32°F to 104°F 0°C to 40°C	
Operation Humidity	10% to 80%	
LG SOFTWARE & SERVICE	SuperSign CMS	Yes
	SuperSign Control	Yes
	SuperSign Control+	Yes (optional for purchase)
	SuperSign White Balance	Yes (optional for purchase)
	SuperSign Media Editor	Yes (optional for purchase)
	LG Connected Care	Yes (optional for purchase)
WARRANTY & OTHER	Warranty	3 Year Limited
	Regulatory	FCC Class "B" / CE / KC
	Environmental	ErP / Energy Star 8.0
	Onscreen Display Languages	English, French, German, Spanish, Italian, Korean, Chinese (Original & Simplified), Portuguese (Portugal & Brazil), Swedish, Finnish, Norwegian, Danish, Japanese, Russian, Dutch, Czech, Greek, Turkish, Arabic
	Included Accessories	Remote Control (includes 2 batteries), Power Cord, RS232C cable, LAN cable, DP cable, IR Receiver, Guide Bracket, Screws, Manual
	Optional Accessories	OPS Kit (KT-OPSF)