



**EASY,
 INCREMENTED
 TILT ADJUSTMENT
 UP TO +20°**

BT893

HEAVY DUTY PROJECTOR CEILING MOUNT WITH MICRO-ADJUSTMENT



Designed to mount projectors up to 70kg, this heavy duty projector mount can be fixed directly to the ceiling or can be mounted to any B-Tech Ø50mm pole (ideal for installing in areas with high ceilings where a larger ceiling drop is required). The projector fixes to an extendable mounting plate, with optional extension legs included to accommodate larger fixing patterns. The mounting plate of the BT893 uses 4-point micro-adjustment for added flexibility, so that a perfectly aligned projection can be achieved.

SPECIFICATION	
Max load	70kg
Tilt (pitch)	+20° / -10° (+/- 5° with micro-adjustment)
Yaw (ceiling mounted)	25°
Yaw (pole mounted)	45°
Roll	+/-5°
Ceiling drop	153mm* (+/-10mm with micro-adjustment)
Max distance between fixings	873mm
Max distance (square fixing pattern)	618mm
Colour options	Black or White

FEATURES

- Designed to mount heavy duty projectors to the ceiling
- Features easy, incremental tilt adjustment
- Micro-adjustment thumbwheels at 4-points for controlled and precise adjustment of the projector
- Ideal for use with projection mapping projectors
- Quick and easy assembly
- Can be mounted to the ceiling directly or to any B-Tech Ø50mm pole
- Optional extension legs can be used to accommodate larger fixing patterns
- Suitable for projectors using M6, M8, M10 and M12 fixings
- All mounting hardware included



Micro-adjustment thumbwheels at 4-points for controlled and precise adjustment of the projector



Can be mounted directly to the ceiling or from any B-Tech Ø50mm pole



Features easy, incremented tilt adjustment



Optional extension legs can be used to accommodate larger fixing patterns

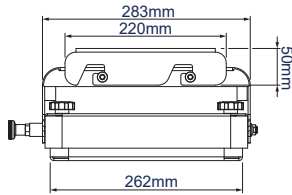

FRONT VIEW

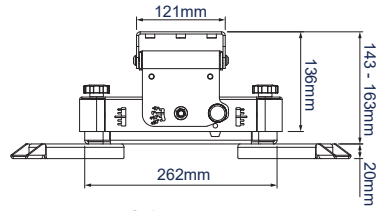

SIDE VIEW WITH INCLUDED SHORT EXTENSION LEGS

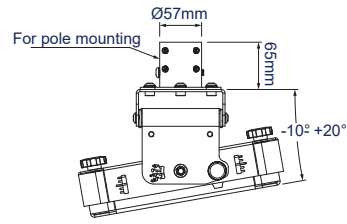

SIDE VIEW WITH INCLUDED POLE ADAPTOR

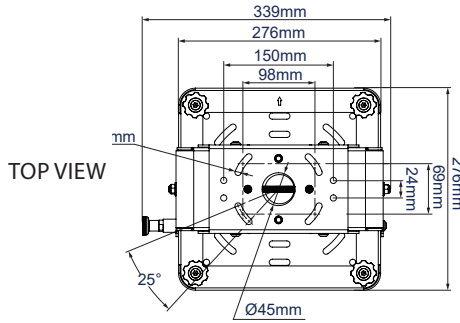

TOP VIEW

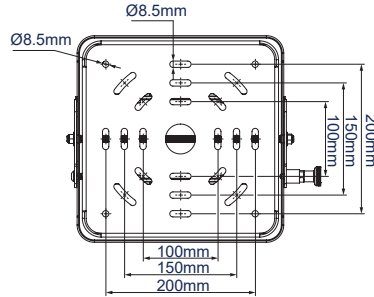

BOTTOM VIEW

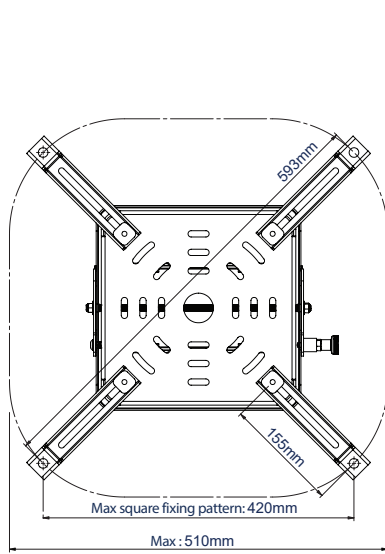

BOTTOM VIEW WITH INCLUDED SHORT EXTENSION LEGS

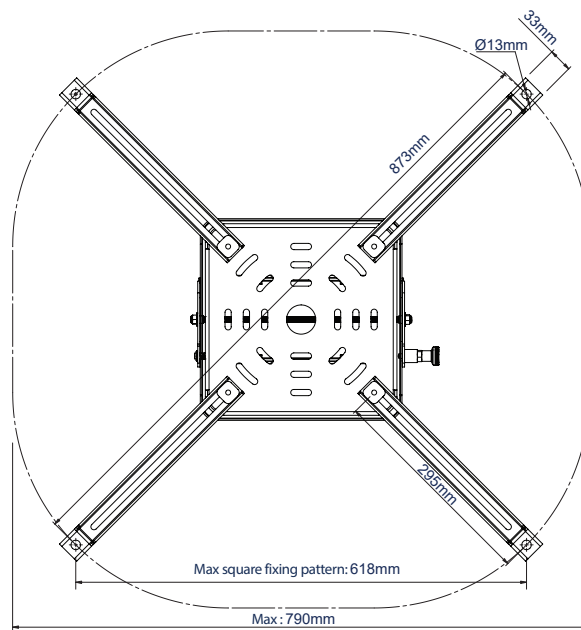

BOTTOM VIEW WITH INCLUDED LONG EXTENSION LEGS

PACKING INFORMATION

Colour:	Order Ref:	EAN Code:	Master Carton Qty:	Inner Carton Qty:	Master Carton Weight:	Master Carton Cube:
Black	BT893/B	5019318759819	1	0	11.5kg	0.025cbm
White	BT893/W		1	0	11.5kg	0.025cbm

ORIGINAL DESIGNS BY B-TECH AV MOUNTS - REGISTERED DESIGNS & PATENTS APPLY

ACCESSORIES and related products



BT7822
Heavy Duty Ceiling Mount can be used with B-Tech poles to create a fixed drop ceiling mount



BT7850
Ø50mm poles are available in a variety of lengths and can be used with **BT7822** & **BT893** to create a fixed drop ceiling mount



BT893-fd
Fixed Drop Heavy Duty Projector Ceiling Mount for projectors up to 70kg



BT893-ad
Adjustable Drop Heavy Duty Projector Ceiling Mount for projectors up to 70kg

© 2019 B-Tech Av Mounts. All rights reserved. The information in this specification is for reference only. B-Tech Av Mounts is a registered trademark of B-Tech International Design & Manufacturing Ltd. We reserve the right to change the technical specifications without prior notice. B-Tech Av Mounts is a registered trademark of B-Tech International Design & Manufacturing Ltd. B-Tech Av Mounts is not liable for loss or damage caused by improper installation or use. Any reproduction or transmission or replication of any part of this specification is strictly prohibited, unless prior written permission has been granted by B-Tech International Design & Manufacturing Ltd. (B-Tech).

SS-V4-BT893-280622