

iPlay4 wall mount plastic loudspeakers

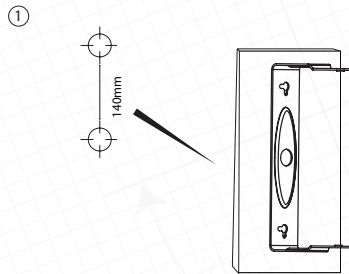

Drill holes according the drawing. Distance between the mounting points -140mm. Fix the loudspeaker bracket on the wall with fasteners suitable for your wall type.

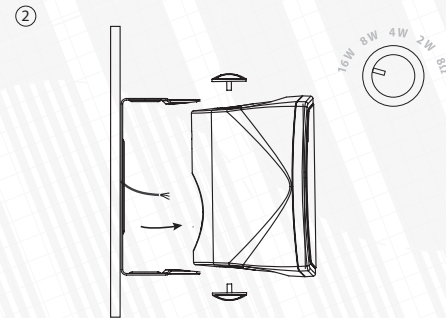

Place loudspeaker to the bracket and tighten by bracket knobs. Connect the wires. Set the desired loudspeaker power tap.

Please pay attention: Mount the loudspeaker on the reliable base only.
Rotate the logo horizontally or vertically depending on used the mounting position.