

LCD MONITOR

User's Manual

MultiSync WD551

Please find your model name in the label on the rear side of the monitor.

MODEL: WD551

Index

Important Information	English-2
Safety Precautions and Maintenance	English-2
Recommended Use & Maintenance.....	English-8
Features	English-9
Contents	English-10
Installation	English-11
Setup Overview.....	English-11
Mounting (for customer).....	English-13
Mounting (for NEC qualified personnel).....	English-13
Parts Name and Functions.....	English-16
Control Panel	English-16
Terminal Interface.....	English-17
Wireless Remote Control	English-18
Operating Range for the Remote Control	English-19
Power Indicator	English-19
Active pen	English-20
Charger	English-21
Connection	English-22
Wiring Diagram	English-22
Connections	English-22
Computer and USB Connection.....	English-23
Connecting to a Computer with USB Type-C.....	English-23
Connecting to a Computer with HDMI.....	English-23
Connecting a USB device	English-23
Input Detection Function	English-24
About the Audio Settings of the Computer.....	English-24
Operation Modes.....	English-25
OSD (On-Screen Display) Controls.....	English-26
General setting.....	English-26
General Setting	English-27
Advanced Setting.....	English-28
External Control.....	English-30
Controlling the Monitor via RS-232C.....	English-30
Troubleshooting.....	English-32
Specifications - Compatible signal list.....	English-34
Specifications - WD551	English-35
Manufacturer's Recycling and Energy Information	English-36
Disposing of your old NEC product.....	English-36
Energy Saving.....	English-36
Appendix Trademark and Software License.....	English-37

Cable Information

CAUTION: Use the attached specified cables with this color monitor so as not to interfere with radio and television reception. For D-Sub 9-Pin, USB, HDMI and USB-C please use a shielded signal cable. Use of other cables and adapters may cause interference with radio and television reception.

FCC Information

WARNING: The Federal Communications Commission does not allow any modifications or changes to the unit EXCEPT those specified by NEC Display Solutions of America, Inc. in this manual. Failure to comply with this government regulation could void your right to operate this equipment.

This equipment has been tested and found to comply with the limits for a Class B digital device, pursuant to part 15 of the FCC Rules. These limits are designed to provide reasonable protection against harmful interference in a residential installation. This equipment generates, uses and can radiate radio frequency energy, and, if not installed and used in accordance with the instructions, may cause harmful interference to radio communications. However, there is no guarantee that interference will not occur in a particular installation. If this equipment does cause harmful interference to radio or television reception, which can be determined by turning the equipment off and on, the user is encouraged to try to correct the interference by one or more of the following measures:

- Reorient or relocate the receiving antenna.
- Increase the separation between the equipment and receiver.
- Connect the equipment into an outlet on a circuit different from that to which the receiver is connected.
- Consult the dealer or an experienced radio/TV technician for help.

If necessary, the user should contact the dealer or an experienced radio/television technician for additional suggestions.

The user may find the following booklet, prepared by the Federal Communications Commission, helpful: "How to Identify and Resolve Radio-TV Interference Problems." This booklet is available from the U.S. Government Printing Office, Washington, D.C., 20402, Stock No. 004-000-00345-4.

SUPPLIER'S DECLARATION OF CONFORMITY

This device complies with Part 15 of FCC Rules. Operation is subject to the following two conditions. (1) This device may not cause harmful interference, and (2) this device must accept any interference received, including interference that may cause undesired operation.



U.S. Responsible Party:	NEC Display Solutions of America, Inc.
Address:	3250 Lacey Rd, Ste 500 Downers Grove, IL 60515
Tel. No.:	(630) 467-3000
Type of Product:	Display Monitor
Equipment Classification:	Class B Peripheral
Model:	WD551

- The intended primary use of this product is as an Information Technical Equipment in an office or domestic environment.
- The product is intended to be connected to a computer and is not intended for the display of television broadcast signals.



- NOTE:**
- (1) The contents of this manual may not be reprinted in part or whole without permission.
 - (2) The contents of this manual are subject to change without notice.
 - (3) Great care has been taken in the preparation of this manual; however, should you notice any questionable points, errors or omissions, please contact us.
 - (4) The image shown in this manual is indicative only. If there is inconsistency between the image and the actual product, the actual product shall govern.
 - (5) Notwithstanding articles (3) and (4), NEC will not be responsible for any claims on loss of profit or other matters deemed to result from using this device.
 - (6) This manual is commonly provided to all regions so they may contain descriptions that are pertinent for other countries.



Important Information

Safety Precautions and Maintenance







FOR OPTIMUM PERFORMANCE, PLEASE NOTE
THE FOLLOWING WHEN SETTING UP AND
USING THE LCD COLOR MONITOR:







About the Symbols







To ensure safe and proper use of the product, this manual uses a number of symbols to prevent injury to you and others as well as damage to property. The symbols and their meanings are described below. Be sure to understand them thoroughly before reading this manual.

 WARNING	Failing to heed this symbol and handling the product incorrectly could result in accidents leading to major injury or death.
 CAUTION	Failing to heed this symbol and handling the product incorrectly could result in personal injury or damage to surrounding property.





Examples of symbols





	<p> Indicates a warning or caution.</p> <p>This symbol indicates you should be careful of electric shocks.</p>
	<p> Indicates a prohibited action.</p> <p>This symbol indicates something that must be prohibited.</p>
	<p> Indicates a mandatory action.</p> <p>This symbol indicates that the power cord should be unplugged from the power outlet.</p>

 WARNING	
1	<div style="display: flex; align-items: center;">  <div style="margin-left: 10px;"> <p>UNPLUG THE POWER CORD</p> </div> </div> <p>Unplug the power cord if the product malfunctions.</p> <p>Should the product emit smoke or strange odors or sounds, or if the product has been dropped or the cabinet broken, turn off the product's power, then unplug the power cord from the power outlet. Failure to do so could not only lead to fire or electric shock, it could also result in vision impairment. Contact your dealer for repairs.</p> <p>Never try to repair the product on your own. Doing so is dangerous.</p>
2	<div style="display: flex; align-items: center;">    </div> <p>Do not open or remove the product's cabinet.</p> <p>Do not disassemble the product.</p> <p>There are high voltage areas in the product. Opening or removing product covers and modifying the product may expose you to electric shock, fire, or other risks.</p> <p>Refer all servicing to qualified service personnel.</p>
3	<div style="display: flex; align-items: center;">  </div> <p>Do not use the product if it has structural damage.</p> <p>If you notice any structural damage such as cracks or unnatural wobbling, please refer servicing to qualified service personnel. If the product is used in this condition, the product may fall or cause personal injury.</p>











 WARNING		
4		<p>Handle the power cord with care. Damaging the cord could lead to fire or electric shock.</p> <ul style="list-style-type: none"> • Do not place heavy objects on the cord. • Do not place the cord under the product. • Do not cover the cord with a rug, etc. • Do not scratch or modify the cord. • Do not bend, twist or pull the cord with excessive force. • Do not apply heat to the cord. <p>Should the cord be damaged (exposed core wires, broken wires, etc.), ask your dealer to replace it.</p>
5		<p>Do not touch the power plug if you hear thunder. Doing so could result in electric shock.</p>
6		<p>Please use the power cord provided with this product in accordance with the power cord table.</p> <p>If a power cord is not supplied with this product, please contact NEC. For all other cases, please use the power cord with the plug style that matches the power socket where the product is located. The compatible power cord corresponds to the AC voltage of the power outlet and has been approved by, and complies with, the safety standards in the country of purchase.</p>
7		<p>For proper installation it is strongly recommended to use a trained service person.</p> <p>Failure to follow the standard installation procedures could result in damage to the product or injury to the user or installer.</p>
8	 	<p>Please install the product in accordance with the following information.</p> <p>This product cannot be used or installed without the table top stand or other mounting accessory for support.</p> <p>When transporting, moving, or installing the product, please use as many people as necessary to be able to lift the product without causing personal injury or damage to the product.</p> <p>Please refer to the instructions included with the optional mounting equipment for detailed information about attaching or removing.</p> <p>Do not cover the vent on the product. Improper installation of the product may result in damage to the product, an electric shock or fire.</p> <p>Do not install the product in the locations below:</p> <ul style="list-style-type: none"> • Poorly ventilated spaces. • Near a radiator, other heat sources, or in direct sunshine. • Continual vibration areas. • Humid, dusty, steamy, or oily areas. • Outdoors. • High-temperature environment where humidity changes rapidly and condensation is likely to occur. • A ceiling or wall that is not strong enough to support the product and mounting accessories. <p>Do not mount the product upside down.</p>



 **WARNING**

9		<p>Prevent tipping and falling for earthquakes or other shocks.</p> <p>To prevent personal injury or damage to the product caused by tipping over due to earthquakes or other shocks, make sure to install the product in a stable location and take measures to prevent falling.</p> <p>The measures to prevent falling and tipping are intended for reducing the risk of injury, but may not guarantee the effectiveness against all earthquakes.</p> <p>The product may tip causing personal injury.</p> <ul style="list-style-type: none"> • When using the product with the optional table top stand, fasten the product to a wall using a cord or chain that can support the weight of the product in order to prevent the product from falling. Fasten the cord or chain to the product using the clamps and screws provided with the product or the table top stand. Depending on the table top stand, the stand has the structure for preventing tipping. • Be sure to remove the cord or chain from the wall before moving the product to prevent personal injury or damage to the product. <p>The product may fall causing personal injury.</p> <ul style="list-style-type: none"> • Do not attempt to hang the product using an installation safety wire. • Please install the product in an area on the wall or ceiling strong enough to support the weight of the product. • Prepare the product using mounting accessories, such as hook, eyebolt, or mounting parts, and then secure the product with a safety wire. The safety wire must not be tight. • Please make sure the mounting accessories are strong enough to support the product weight and size before installing it. <p>Stability Hazard.</p> <p>The product may fall, causing serious personal injury or death. To prevent injury, this product must be securely attached to the floor/wall in accordance with the installation instructions.</p> <p>A product set may fall, causing serious personal injury or death. Many injuries, particularly to children, can be avoided by taking simple precautions such as:</p> <ul style="list-style-type: none"> • ALWAYS use stands or installation methods recommended by the manufacturer of the product set. • ALWAYS use furniture that can safely support the product. • ALWAYS ensure the product is not overhanging the edge of the supporting furniture. • ALWAYS educate children about the dangers of climbing on furniture to reach the product or its controls. • ALWAYS route cords and cables connected to your product so they cannot be tripped over, pulled or grabbed. • NEVER place a product in an unstable location. • NEVER place the product on tall furniture (for example, cupboards or bookcases) without anchoring both the furniture and the product to a suitable support. • NEVER place the product on cloth or other materials that may be located between the product and supporting furniture. • NEVER place items that might tempt children to climb, such as toys and remote controls, on the top of the product or furniture on which the product is placed. • If the existing product is going to be retained and relocated, the same considerations as above should be applied.
10		<p>Do not place this product on a sloping or unstable cart, stand or table. Doing so could lead to falling or tipping and cause personal injury.</p>
11	 	<p>Do not insert objects of any kind into the cabinet. It may cause electric shock, fire, or product failure. Keep objects away from children and babies.</p>
12		<p>Do not spill any liquids into the cabinet or use your product near water.</p> <p>Immediately turn off the power and unplug your product from the wall outlet, then refer servicing to qualified service personnel. It may cause an electric shock or start a fire.</p>

 WARNING		
13		Do not use flammable gas sprays to remove dust when cleaning the product. Doing so could lead to a fire.
14	 	Do not open the fuse cover, remove or replace the fuse. It may cause electric shock.

 **CAUTION**

1	  	<p>Handling the power cord.</p> <p>Handle the power cord with care. Damaging the cord could lead to fire or electric shock.</p> <ul style="list-style-type: none"> • When connecting the power cord to the product's AC IN terminal, make sure the connector is fully and firmly inserted. • Fasten the power cord to the product by attaching the screw and clamp to prevent loose connection. (Recommended Fasten Force: 29.5 - 49 N•cm). • Do not connect or disconnect the power cord with wet hands. • When connecting or disconnecting the power cord, pull the power cord out by holding onto its plug. • When cleaning the product, for safety purposes, unplug the power cord from the power outlet beforehand. Regularly dust off the power cord by using a soft dry cloth. • Before moving the product, make sure the product power is off, then unplug the power cord from the power outlet and check that all cables connecting the product to other devices are disconnected. • When you are not planning to use the product for an extended period of time, always unplug the power cord from the power outlet. • This equipment is designed to be used in the condition of the power cord connected to the earth. If the power cord is not connected to the earth, it may cause electric shock. Please make sure the power cord is earthed properly.
2		<p>Do not bind the power cord and the USB cable. It may trap heat and cause a fire.</p>
3		<p>Do not connect to a LAN with excessive voltage.</p> <p>When using a LAN cable, do not connect to a peripheral device with wiring that might have excessive voltage. Excessive voltage on the LAN port may cause an electric shock.</p>
4		<p>Do not climb on the table where the product is installed. Do not install the product on a wheeled table if the wheels on the table have not been properly locked. The product may fall, causing damage to the product or personal injury.</p>
5		<p>Installation, removal, and height adjustment of the optional table top stand.</p> <ul style="list-style-type: none"> • When installing the table top stand, handle the unit with care to avoid pinching your fingers. • Installing the product at the wrong height can cause tipping. Please install your product at proper height to prevent personal injury or damage to the product.
6		<p>Do not push or climb on the product. Do not grab or hang onto the product.</p> <p>The product may fall, causing damage to the product or personal injury.</p>
7		<p>Do not impact the LCD panel surface, it can cause serious damage to the product or personal injury.</p>
8		<p>Incorrect usage of batteries can result in leaks or bursting.</p> <ul style="list-style-type: none"> • Insert batteries matching the (+) and (-) signs on each battery to the (+) and (-) signs of the battery compartment. • Do not mix battery brands. • Do not combine new and old batteries. This can shorten battery life or cause liquid leakage of batteries. • Remove dead batteries immediately to prevent battery acid from leaking into the battery compartment. • Do not touch exposed battery acid, it may injure your skin. • Disposal of a battery into fire or a hot oven, or mechanically crushing or cutting of a battery, that can result in an explosion. • Leaving a battery in an extremely high temperature surrounding environment, or a battery subject to extremely low air pressure, that can result in an explosion or the leakage of flammable liquid or gas. • Contact your dealer or local authorities when disposing of batteries.

 CAUTION	
9 	Suitable for entertainment purposes at controlled luminous environments, to avoid disturbing reflections from the screen.
10 	To ensure the product's reliability, please clean the ventilation holes at the rear side of the cabinet at least once a year to remove dirt and dust. Failure to do so could lead to fire or electric shock or damage to the product.

Power Cord Table

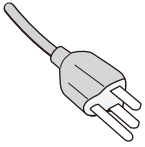
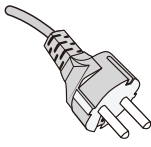
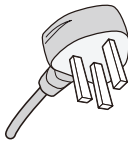
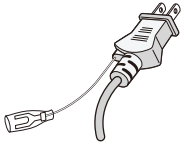
Plug Type	North America	European Continental	U.K.	Japanese
Plug Shape				
Region	U.S.A./Canada	EU	U.K.	Japan
Voltage	120*	230	230	100

* Please use this power cord under 125 V power supply.

NOTE: This product can only be serviced in the country where it was purchased.

Image Persistence

Image persistence occurs when a residual or “ghost” image of a previous image remains visible on the screen. Unlike CRT monitors, LCD monitors’ image persistence is not permanent, but a still image being displayed for a long period of time should be avoided.

To alleviate image persistence, turn off the monitor for as long as the previous image was displayed. For example, if an image was on the monitor for one hour and a residual image remains, the monitor should be turned off for one hour to erase the image.

NOTE: As with all personal display devices, NEC DISPLAY SOLUTIONS recommends using a moving screen saver at regular intervals whenever the screen is idle, or turn off the monitor when not in use.

Recommended Use & Maintenance

Recommended Use

Ergonomics

To realize the maximum ergonomic benefits, we recommend the following:

- For optimum performance of the monitor, allow 20 minutes for warming up. Avoid reproduction of still patterns on the monitor for long periods of time to avoid image persistence (after image effects).
- Rest your eyes periodically by focusing on an object at least 5 feet away. Blink often.
- Position the monitor at a 90° angle to windows and other light sources to minimize glare and reflections.
- Adjust the monitor's brightness controls to enhance readability.
- Get regular eye checkups.
- Use the preset Size and Position controls with standard input signals.
- Use the preset color settings.
- Use non-interlaced signals.
- Do not view the primary color blue on a dark background. It is difficult to see and may cause eye fatigue due to insufficient contrast.

Maintenance

Cleaning the LCD Screen

- When the LCD screen is dusty, please gently wipe with a soft cloth.
- Clean the LCD screen surface with a lint-free, non-abrasive cloth. Avoid using any cleaning solution or glass cleaner!
- Please do not rub the LCD screen with a hard or abrasive material.
- Please do not apply pressure to the LCD screen surface.
- Please do not use OA cleaner as it will cause deterioration or discoloration on the LCD screen surface.

Cleaning the Cabinet

- Unplug the power supply.
- Gently wipe the cabinet with a soft cloth.
- To clean the cabinet, dampen the cloth with a neutral detergent and water, wipe the cabinet and follow with a dry cloth.

NOTE: DO NOT clean with benzene thinner, alkaline detergent, alcoholic system detergent, glass cleaner, wax, polish cleaner, soap powder, or insecticide. Rubber or vinyl should not be in contact with the cabinet for an extended period of time. These types of fluids and materials can cause the paint to deteriorate, crack or peel.

Features

Windows Certified

Microsoft certified “Windows collaboration display”.

Featuring Microsoft Teams certified 4k cameras, microphones, and speakers.

Simple and convenient

- Connects to a computer with a single USB Type-C cable.
- Equipped with a 4k camera, microphone, and speaker.
- Input detection automatically switches the input terminal when connecting a computer.
- Operate a connected computer via the touch panel.
- Provides a power supply of up to 65W from the USB Type-C port and charges a connected computer while using the monitor.

Equipped with various sensors

- Presence sensor detects when people are present in the room and automatically turns the display on or off. This setting can be enabled or disabled (see [page 28](#)).
- Temperature, humidity, light, and CO₂ sensor data can be uploaded to the cloud, and the environment data can be evaluated using a cloud service. (Please contact your dealer for cloud service information.)

Contents

Your new monitor box* should contain the following:

- LCD monitor
- Power cord*¹
- Bracket(for Charger)
- USB Type-C Cable
- Bracket (for charger) mounting screw (spare) x 2*³
- Wireless Remote Control and AAA Batteries x 2*²
- Active Pen x 2, Charger
- Clamp
- Setup Manual

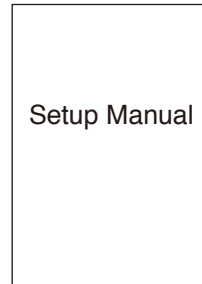
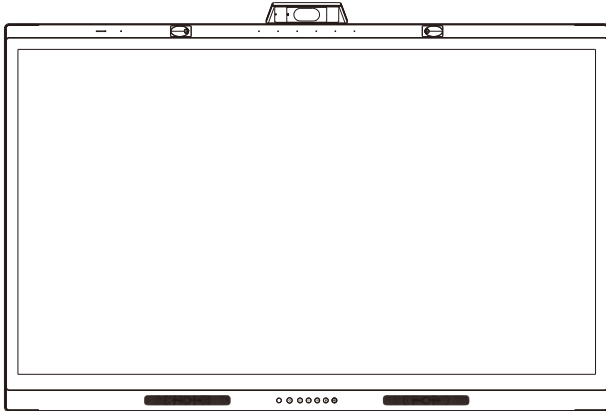

Setup Manual



Clamp

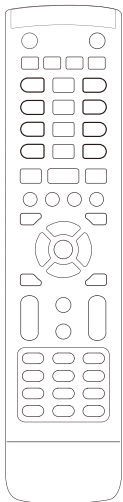

Wireless Remote Control and AAA Batteries x 2*²

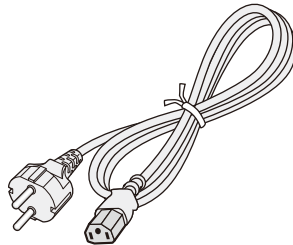

Power cord*¹

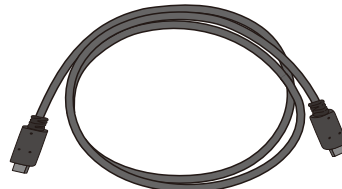

USB Type-C Cable

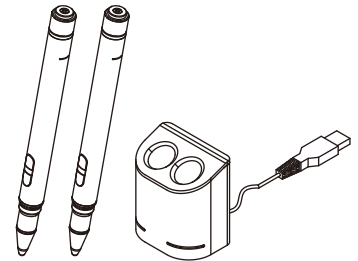

Active Pen x 2, Charger

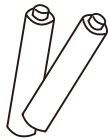

Bracket (for Charger)

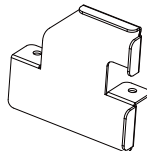

Bracket (for charger) mounting screw (spare) x 2*³

* Remember to save your original box and packing material to transport or ship the monitor.

*¹ Type and number of power cords included will depend on the where the LCD monitor is to be shipped. When more than one power cord is included, please use a power cord that matches the AC voltage of the power outlet and has been approved by and complies with the safety standard of your particular country.

*² Depending on the country where the LCD monitor is shipped to, AAA batteries are not included in the box contents.

*³ Use the screws already installed to the main unit to install the bracket (see [page 21](#)).

Installation

⚠ CAUTION:

For proper installation, it is strongly recommended to use a trained, NEC authorized service person. Failure to follow NEC standard mounting procedures could result in damage to the equipment or injury to the user or installer. Product warranty does not cover damage caused by improper installation remodeling or natural disasters. Failure to follow these recommendations could result in voiding the warranty.

Setup Overview

1. Determine the installation location

⚠ CAUTION:

- Installing your LCD monitor must be done by a qualified technician. Contact your supplier for more information.
- Moving or installing the LCD monitor must be done by two or more people. Failure to follow this caution may result in injury if the LCD monitor falls.
- Do not mount or operate the monitor upside down.

NOTE:

To avoid scratching the LCD panel, always place a soft cloth, such as a blanket that is larger than the monitor's screen area, on the table before laying the monitor face down when installing the mounting accessories.

2. Install the remote control batteries

The remote control is powered by two 1.5V AAA batteries. To install or replace batteries:

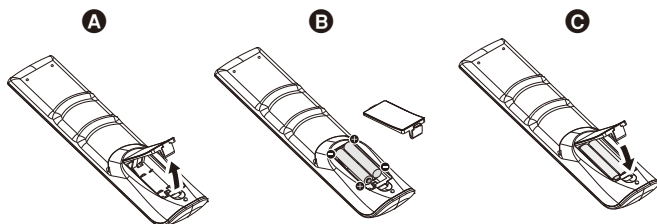

- Press-and-hold the lock tab, then lift the battery compartment cover from the remote control.
- Align the batteries according to the (+) and (-) indications inside the case.
- Replace the cover.

NEC recommends the following battery use:

⚠ CAUTION:

Incorrect usage of batteries can result in leaks or bursting.

- Place "AAA" size batteries matching the (+) and (-) signs on each battery to the (+) and (-) signs of the battery compartment.
- Do not mix battery brands.
- Do not combine new and old batteries. This can shorten battery life or cause liquid leakage of batteries.
- Remove dead batteries immediately to prevent battery acid from leaking into the battery compartment.
- Do not touch exposed battery acid, it may injure your skin.

NOTE:

If you do not intend to use the Remote Control for a long period of time, remove the batteries.

3. Connect external equipment

Refer to the user's manual of your equipment for further information.

4. Connect the supplied power cord

- The equipment should be installed close to an easily accessible power outlet.
- Fasten the power cord to the LCD monitor by attaching the clasper.
- Fully insert the Plug into the power outlet socket. A loose connection may cause image degradation.

⚠ WARNING:

- Please refer to the "Important Information" section of this user's manual for proper selection of an AC power cord. (Recommended Fasten Force: 29.5 - 49 N•cm)

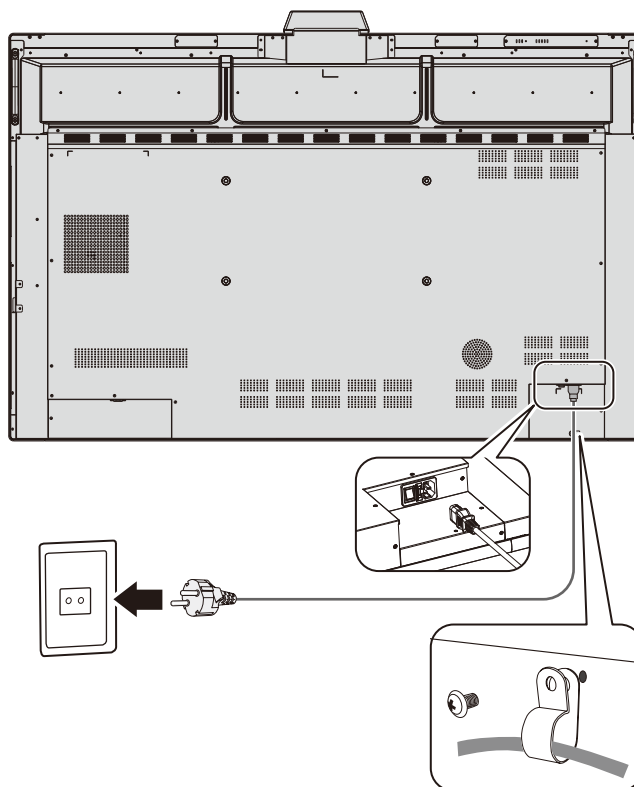

5. Cable information

CAUTION:

Use the provided specified cables with this color monitor so as not to interfere with radio and television reception.



For D-Sub 9-Pin, USB, HDMI, and USB Type-C please use a shielded signal cable.

Use of other cables and adapters may cause interference with radio and television reception.

When using USB-C port for video / audio, please use SuperSpeed USB (USB 3.2 Gen 1) cable with USB compliance logo.

6. Power ON and OFF Modes

Switch the main power to the ON position.

Press the  button on the Control Panel or  button on the Remote Control to turn on the monitor.

The monitor's power LED indicates the current status of the monitor. Please refer to the table for information about the LED indicator.

It is possible to shift to standby mode by holding down the  button on the main unit for 2 seconds during operation

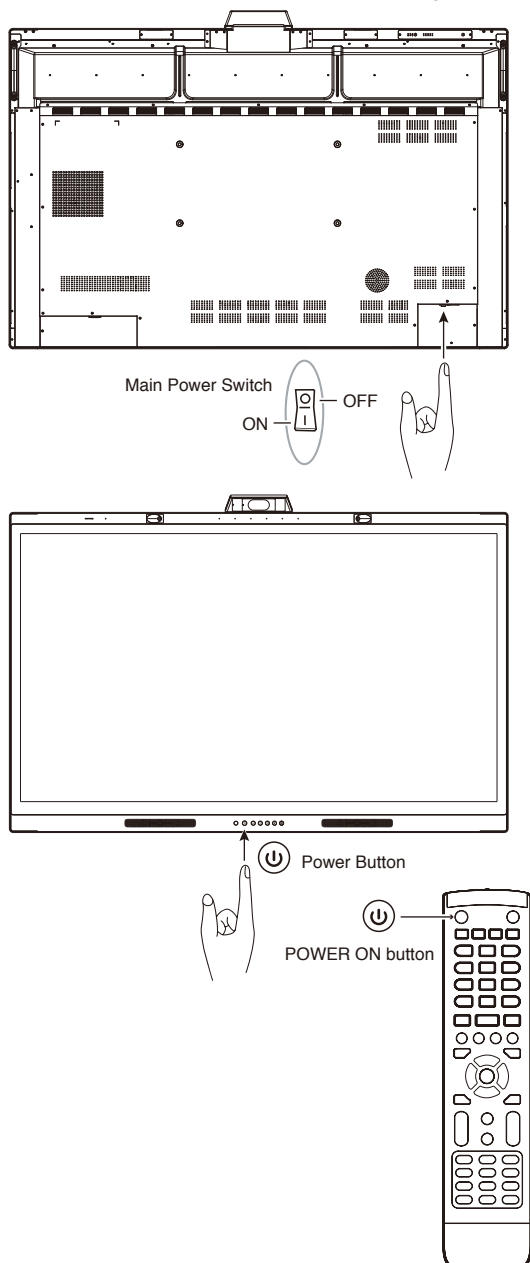

NOTE: When connected with a computer, switch on the power of the computer first.

Mounting (for customer)

⚠ WARNING:

DO NOT mount the monitor yourself. This device cannot be used or installed without a mounting accessory for support. For proper installation, it is strongly recommended to use a trained, qualified technician. Failure to follow NEC standard mounting procedures could result in damage to the equipment or injury to you. Please contact your supplier as they may be able to provide a list of qualified installation professionals. Mounting on a wall or ceiling and hiring a technician is the customer's responsibility.

Maintenance

- Periodically check for loose screws, gaps, distortions, or other problems that may occur with the mounting equipment. If a problem is detected, please refer to qualified personnel for service.
- Regularly check the mounting location for signs of damage or weakness that may occur over time.
DO NOT block ventilated openings with mounting accessories or other accessories.

Mounting (for NEC qualified personnel)

Stability Hazard.

The device may fall, causing serious personal injury or death. To prevent injury, this device must be securely attached to the floor/wall in accordance with the installation instructions. Carefully inspect the location where the unit is to be mounted. Not all walls or ceilings are capable of supporting the weight of the unit. Weight of this monitor is mentioned in the Specification (see [page 35](#)).

Product warranty does not cover damage caused by improper installation, re-modeling, or natural disasters. Failure to comply with these recommendations could result in voiding the warranty.

To ensure safe installation, use two or more brackets to mount the unit. Mount the unit to at least two points on the installation location.

⚠ WARNING:

Failure to follow NEC standard mounting procedures could result in damage to the equipment or injury to the user or installer.

Please note the following when mounting on wall or ceiling

- NEC recommends mounting interfaces that comply with UL1678 standard in North America.
- NEC strongly recommends using size M8 screw (18-20 mm + thickness of bracket and washers in length). If using screws longer than 18-20 mm, check the depth of the hole. (Recommended Fasten Force:1000 - 1200N·cm).
- Prior to mounting, inspect the installation location to ensure that it is strong enough to support the weight of the unit so that the unit will be safe from harm.
- For detailed information, refer to the instructions included with the mounting equipment.
- Make sure that there is no gap between the monitor and the bracket.

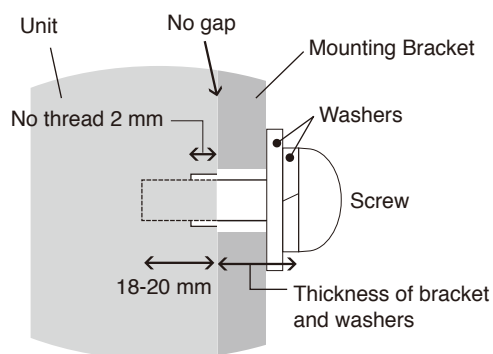

Installing a safety wire

⚠ CAUTION:

The monitor may fall causing damage to the monitor or personal injury. To prevent the monitor from falling off from the wall or ceiling, NEC strongly recommends using a safety wire.

- Do not attempt to hang the monitor using an installation safety wire. The monitor must be properly installed.
- Please install the monitor in a spot of the wall or ceiling strong enough to support the monitor.
- To prevent the monitor from falling off from the wall or ceiling, NEC strongly recommends using a safety wire.
- Prepare the monitor using mounting accessories such as hook, eyebolt or mounting parts and then secure the monitor with a safety wire. The safety wire must not be tight.
- Please make sure the mounting accessories are strong enough to support the monitor before mounting it.

Mounting location

⚠ CAUTION:

Improper installation of the monitor may result in damage to the monitor, an electric shock or fire. Do not install the monitor in the locations below:

- DO NOT install in locations where a door or gate can hit the unit.
- DO NOT install in areas where the unit will be subjected to strong vibrations and dust.
- DO NOT install the monitor next to a location where the main power supply is fed into the building.
- DO NOT install the monitor in a location where people can easily grab and hang onto the unit or the mounting equipment.

NOTE:

- The ceiling or wall must be strong enough to support the monitor and mounting accessories.
- To avoid scratching the LCD panel, always place a soft cloth, such as a blanket that is larger than the monitor's screen area, on the table before laying the monitor face down when installing the monitor stand or mounting accessories.
- Be careful not to crush the camera or buttons.

Attaching Mounting Accessories

The monitor is designed for use with a mounting system.

Be careful to avoid tipping the monitor when attaching accessories.

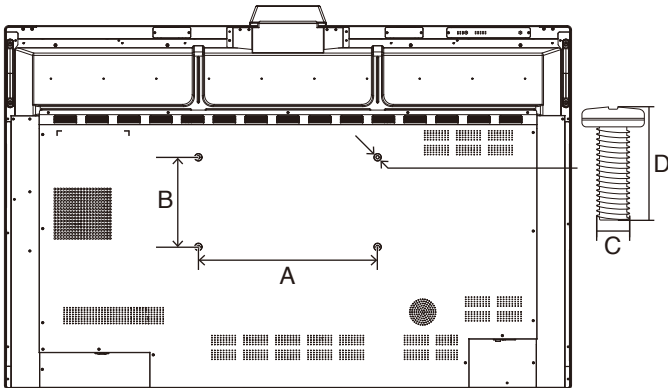

inch	Spec. (A x B)	Standard screw (C x D)	Quantity
WD551	400 x 200 mm	M8 x 25 mm	4

Mounting accessories can be attached with the monitor in the face down position. Make sure there is nothing on the table that can damage the monitor.

- NOTE:** Prior to installation, place the monitor face down on a flat even surface that is larger than the monitor screen. Use a sturdy table that can easily support the weight of the monitor.

Ventilation Requirements

When mounting in an enclosed space or recessed area, leave adequate room between the monitor and the enclosure to allow heat to disperse, as shown below.

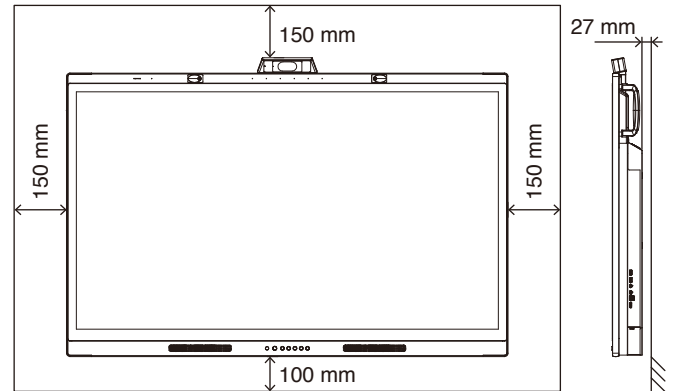

Allow adequate ventilation or provide air conditioning around the monitor, so that heat can properly dissipate away from the unit and the mounting equipment.

Initial Setup

When using the monitor for the first time, follow the screen instructions to perform the initial setup.

1. Start the initial setup

Press the [Start] button to start the initial setup.

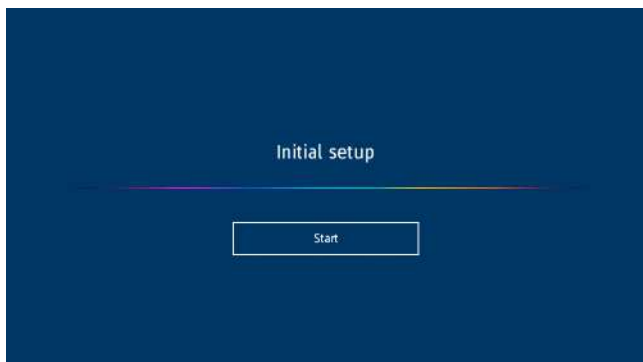

4. Set the time

Select whether to set the time automatically or manually. To set the time automatically, connect the monitor to a network using the LAN port and select a time zone. To set the time manually, disable [Network Time]. Set the date and time after selecting the time zone.



2. Select a language

Select the language for the OSD menu.

You can select a language from the following 9 available languages.

English / French / German / Spanish / Italian / Russian / Swedish / Chinese / Japanese

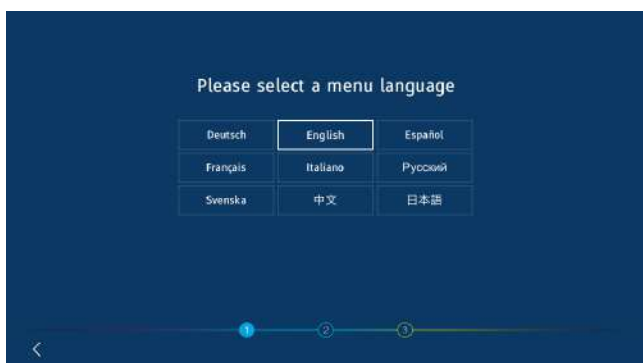

5. Initialization complete

The Welcome screen is displayed when the initial setup is complete.

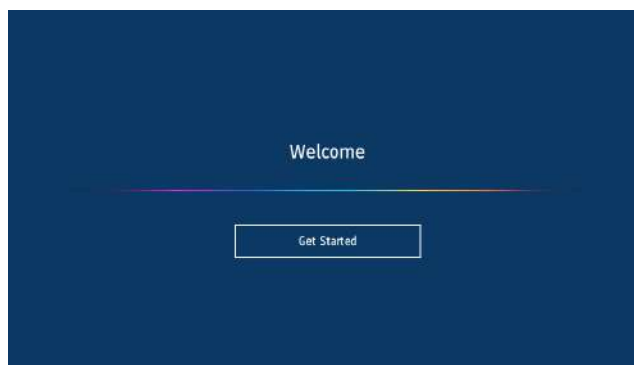

3. Select a mode

Select the operation mode of the monitor.

Select the WCD mode to fully use the functions of the monitor.



Parts Name and Functions

Control Panel

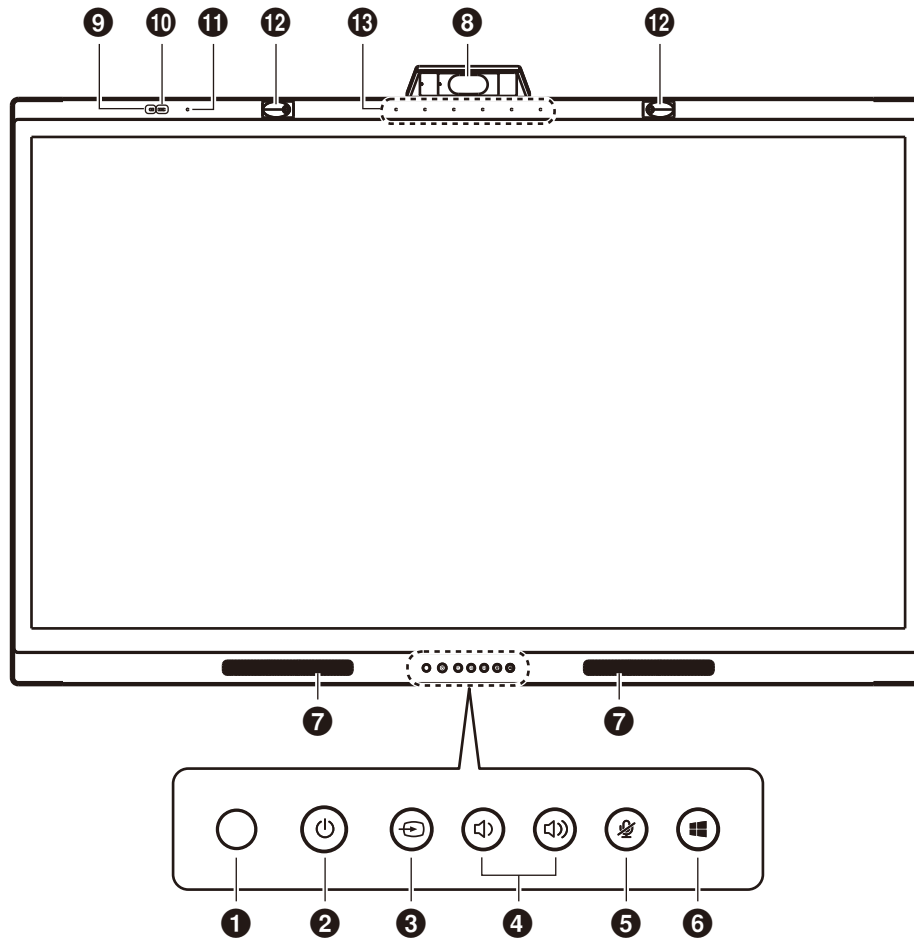

1 Remote control sensor

Receives signal from the IR remote control.

2 Button & Power indicator

Tap to enter Screen off, press at least 2 seconds to enter standby. Back-lit with an LED as a power and status indicator.

3 Button

The Monitor will search for the available input source and display it. The input source will change as follows:
[USB-C 1] -> [USB-C 2] -> [HDMI]

4 / Button

Increase or decrease output volume level.

NOTE: When connected to a computer, volume adjustment is made on the computer.

5 Button

Turn microphone mute on/off.

6 Button

Corresponds to the  key on a Computer.

7 Speaker

8 Camera

9 Air quality sensor

10 Light sensor

11 Temperature & Humidity sensor

12 Presence sensor

13 Microphone array

Terminal Interface

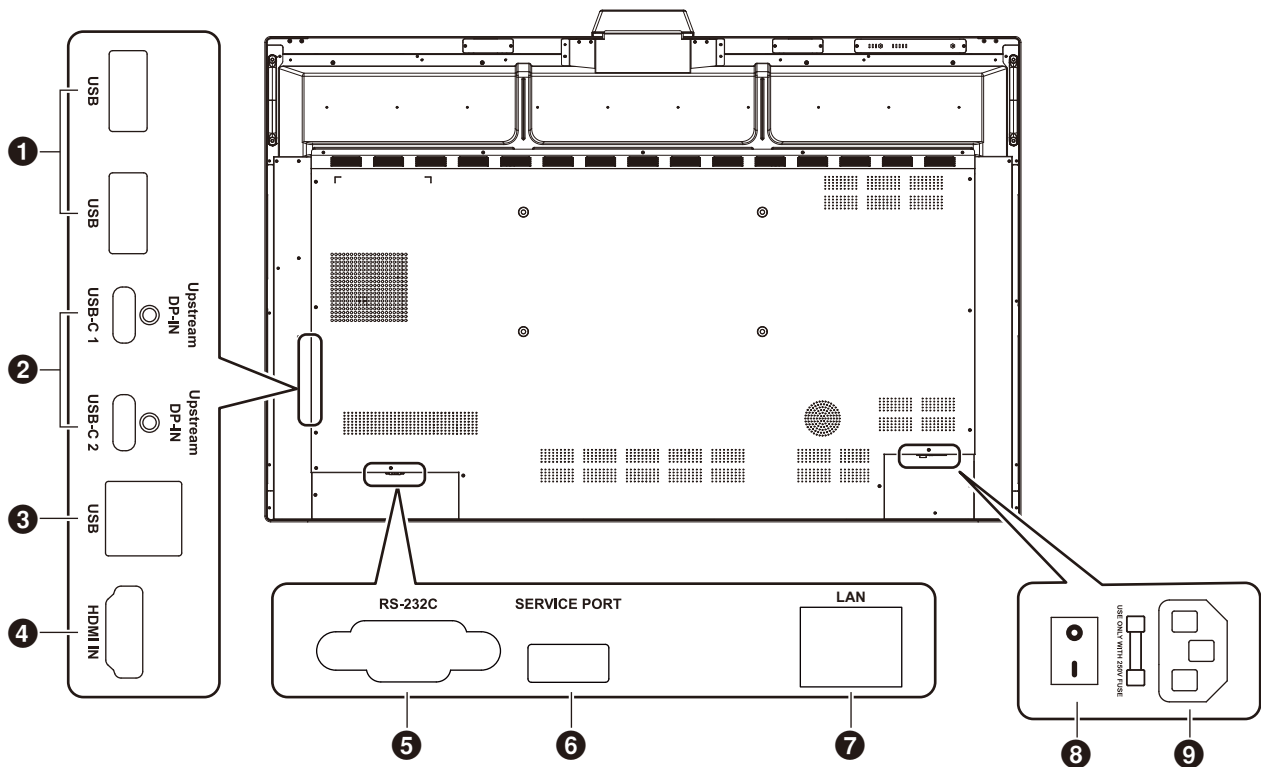

1 USB3.0 Downstream Port (Type-A)

Connect USB devices such as a portable hard drive, U disk, USB keyboard and mouse, and USB drive. The Active pen charger also connects here.

2 USB-C (Type-C)

Connects with USB Type-C compliant external equipment such as a computer. Please refer to “[Connecting to a Computer with USB Type-C](#)” on [page 23](#) for more information.

3 USB Upstream Port (Type-B)

By connecting to a computer, the touch function, camera function, USB-HUB function, etc. can be used.

Note: Use this connection when the monitor is connected to the computer via HDMI cable.

4 HDMI IN

HDMI signal input, connect to devices with HDMI output interface (personal computer with HDMI output, set-top box, or another video device).

5 RS-232C IN (D-Sub 9-pin)

Serial interface, used for transfer of data between devices.

6 SERVICE PORT

(for service purpose only)

7 LAN PORT

LAN cable connection.

Used for time setting and connection to cloud.

You cannot connect to a normal network.

8 Main Power SWITCH

Turns on or off main AC power supply. “**I**” means power on, “**O**” means power off.

9 AC Inlet

AC power input for connecting the AC power cord.

NOTE: When connecting a computer to the USB Type-C port on the monitor, it is unnecessary to connect to the USB upstream port (Type-B). If you connect to both USB ports, the computer may not operate properly.

Wireless Remote Control

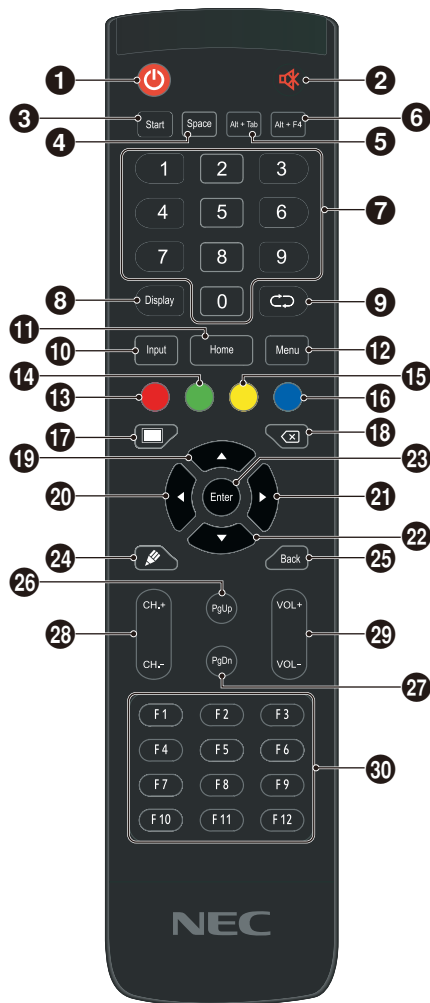

- 1** Power on/off
- 2** Speaker Mute switch
- 3** **Start**
Computer keyboard Windows key
- 4** **Space**
Computer keyboard spacebar key
- 5** **Alt+Tab**
Computer keyboard spacebar Alt + Tab
- 6** **Alt+F4**
Computer program window close button
- 7** **Numeric keys**
Numeric input keys
- 8** **Display**
Display channel information
- 9** Non-function
- 10** **Input**
Input signal source selection key, choose different sources according to need
- 11** **Home**
System main screen button

- 12** **Menu**
Setting menu button, press this button to pop up the OSD menu
- 13** **Red**
Lock and unlock Buttons and Touch function
- 14** **Green**
Lock and unlock Buttons function
- 15** **Yellow**
Lock and unlock Touch function
- 16** **Blue**
Unlocks the Buttons and Touch functions.
- 17** Switch between Running (Full power) and Screen off.*1
- 18** Backspace key
- 19** Direction key, press this button for upwards selection
- 20** Direction key, press this button for left selection
- 21** Direction key, press this button for right selection
- 22** Direction key, press this button for downwards selection
- 23** **Enter**
Confirmation key, press this key to confirm selection state
- 24** Non-function
- 25** **Back**
Return key
- 26** **PgUp**
Computer keyboard PageUp key
- 27** **PgDn**
Computer keyboard PageDown key
- 28** **CH.+ / CH.-**
Non-function
- 29** **VOL+ / VOL-**
Volume control
- 30** **F1-F12**
Computer F1 - F12 function keys

*1 When switching to the Screen off in WCD mode, the presentation sensor may react and immediately return to the Running state(Full power).

Operating Range for the Remote Control

Use the remote control within a distance of about 8 m (26 ft.) from the remote control sensor, or at a horizontal and vertical angle of within 30° and within a distance of about 4 m (13 ft.).

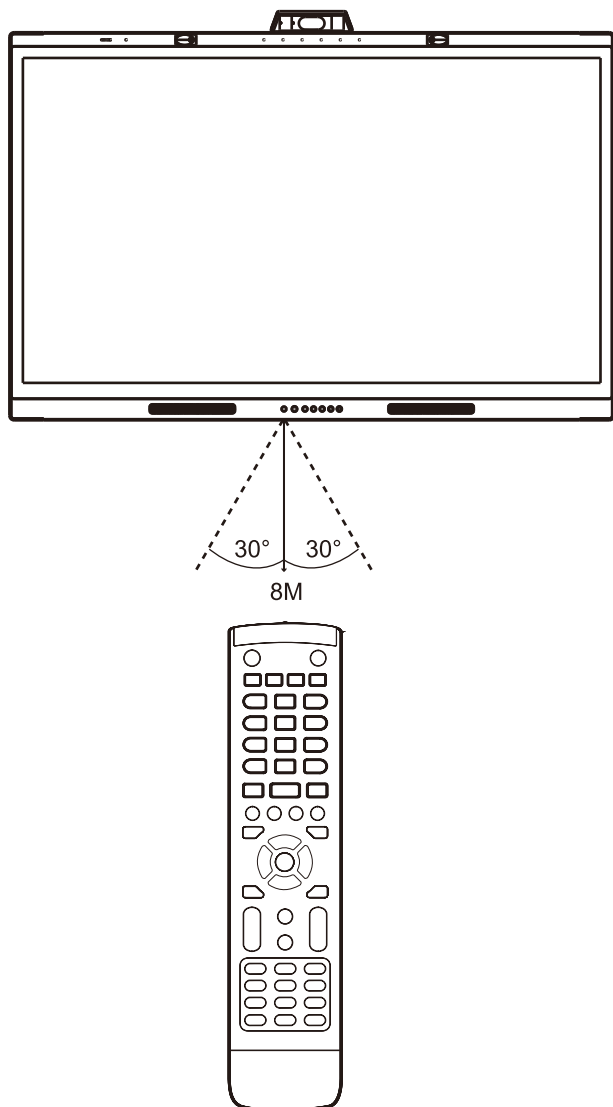

Power Indicator

LED indicator status	Machine status
Glowing blue	Running or booting.
Glowing red	Standby.
Blinking between blue and red slowly	Screen off (Turn off the backlight).
Blinking between blue and red fastly	Shutting down or received remote control signal.

Caution: The remote control system may not function when direct sunlight or strong illumination strikes the remote control sensor, or when there is an object in the path.

Handling the remote control

- Do not expose to strong shock.
- Do not allow water or other liquid to splash on the remote control. If the remote control gets wet, wipe it dry immediately.
- Avoid exposure to heat and steam.
- Except to install the batteries, do not open the remote control.

Active pen

The active pen that came with the monitor is compatible with the touch screen and can control the monitor and the connected computer.

NOTE: The active pen is rechargeable and can be recharged with the provided charger.

Full charge time: Approximately 3 minutes

Continuous use time: Approximately 120 minutes

The continuous use time is the time given as a reference during which the pen can be used when fully charged.

The pen continuously consumes power even when not actively in use. Since the battery power is consumed whenever it is not on the charger, we recommend placing the pen in the charger to charge it when not using it. This will not damage the rechargeable battery.

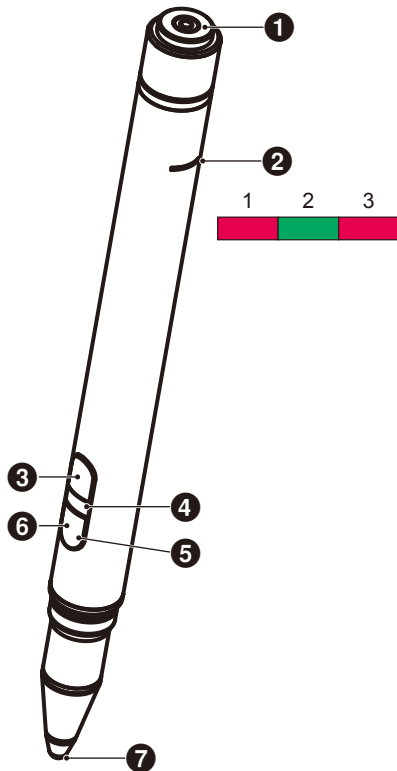

❶ Charging Terminal

Connect to the charger.

❷ Charging Light

1) Charging Light (Red light)

Lights during charging.

2) Power Light (Green light)

Lights while connected to the charger.

3) Low Battery Light (Red light)

Lights when the battery is low. It recommends early charging.

❸ Upper Button

Right-click the mouse.

❹ ID Color Light

Used to distinguish between the two included pens. Each is colorless and red.

❺ Active Light

The white light flashes when the pen is ready for use.

❻ Lower Button

Functions as an eraser.

❼ Pen Tip

Charger

When charging, connect the pen so that the charging terminal of the active pen is on the charger side.

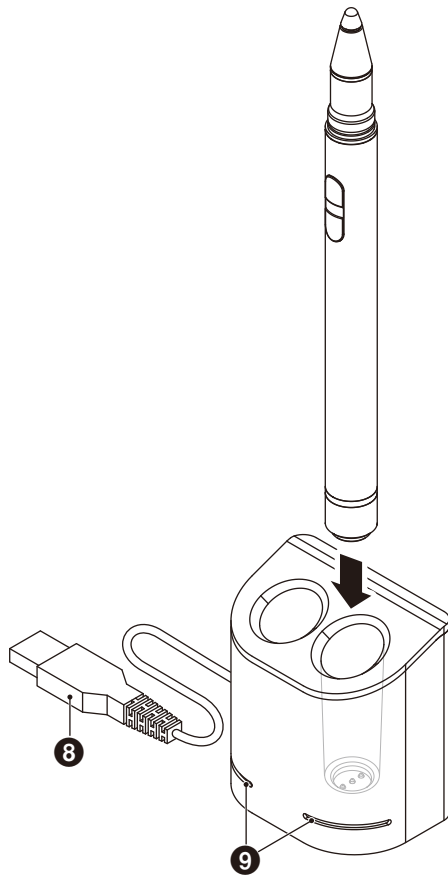

8 USB-A Terminal

Connect the charger to a USB-A port.

NOTE: The charger can be connected to the USB-A terminal on the monitor, a computer, or other USB-A compatible charger.

9 Status Light

Lights green when the active pen is not inserted or the active pen is fully charged.

The light turns off while the active pen is charging.

⚠ CAUTION:

Do not put your fingers or foreign objects in the charger.

Installing the charger

The charger has a magnet embedded in the back. It can be attached to metal parts such as the back of the display. By using the included Bracket, it is also possible to attach the charger to the side of the display.

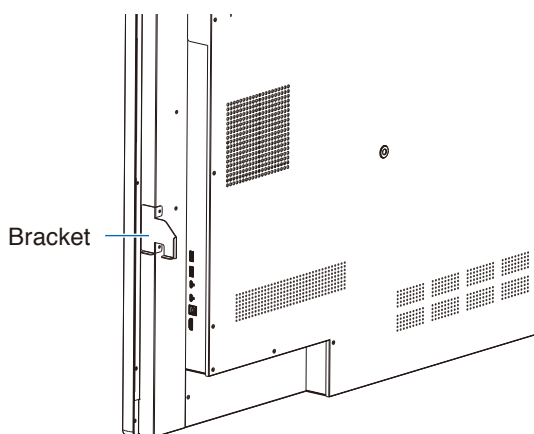

There is a Bracket mounting location on the terminal side of the main unit. Remove the screws and install the Bracket.

⚠ CAUTION:

Do not apply force while installing the bracket. The bracket may become warped and damaged.

Connection

Wiring Diagram

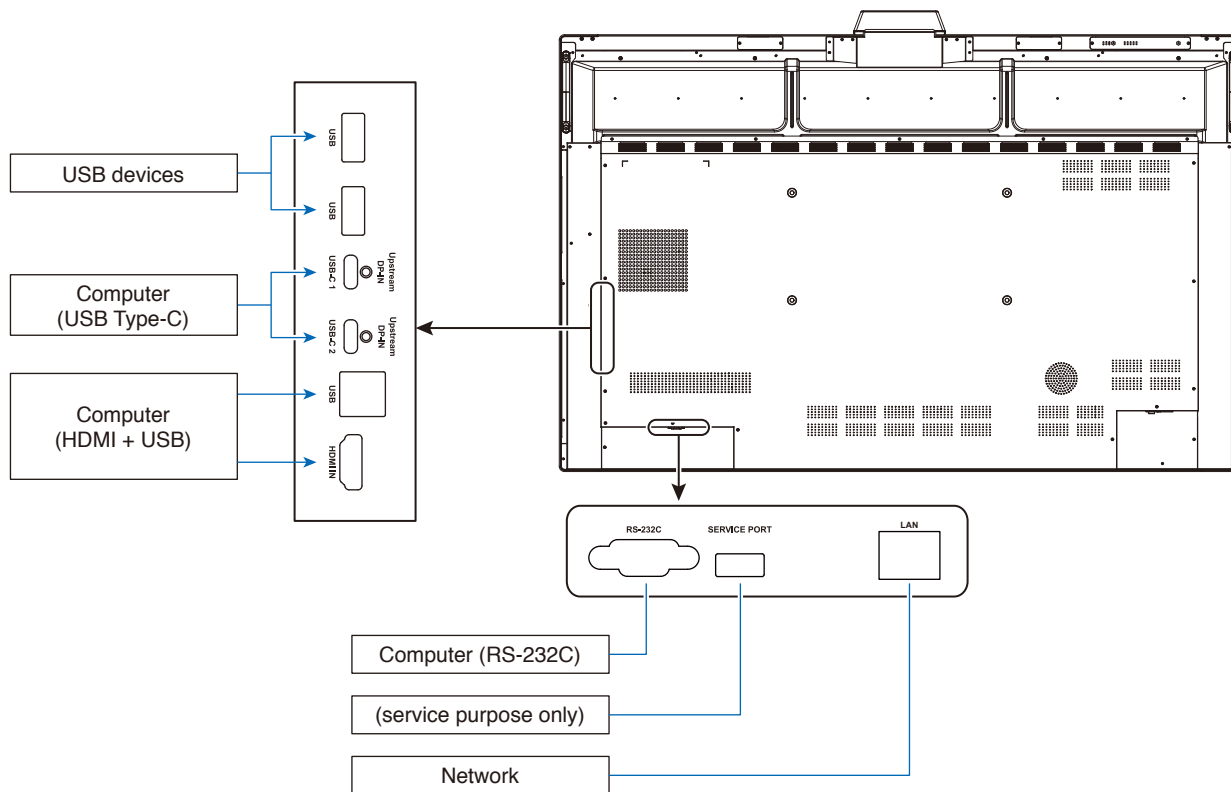

Connections

Before making connections:

- * Refer to the user's manual included with each separate piece of equipment.
- * We strongly recommend connecting or disconnecting a USB storage device to the monitor when the monitor's main power is off.

Connected equipment	Connecting terminal	Input signal name	Connecting audio terminal
Computer	HDMI	HDMI	HDMI
	USB-C 1	USB-C 1	USB-C 1
	USB-C 2	USB-C 2	USB-C 2

Please set appropriate setting for input signal.

Computer and USB Connection

Option 1: USB-C

- 1) Use a USB Type-C cable to connect to the USB-C output port of the external computer.
- 2) Press the Input key to switch to the USB-C channel.*1

Option 2: HDMI

- 1) Use a USB cable to connect to the USB Type-B port on the monitor and to a USB Type-A port on the external computer.
- 2) Use an HDMI cable to connect to the HDMI output port of the external computer.
- 3) Press the Input key to switch to the HDMI channel.*1

*1 If the input detection function is set to "ON", the terminals will switch automatically after connecting the computer (see [page 29](#)).

Connecting to a Computer with USB Type-C

- When using the USB-C port for video / audio, please use a SuperSpeed USB (USB 3.2 Gen 1) cable with USB compliance logo.
- When using USB-C port for video / audio, please use a computer port with DP Alt Mode compliance logo.
- HDMI Alt Mode or MHL is not supported.
- When using computer battery charging (Power delivery), please use computer and cable with USB Power Delivery compliance logo.
- Please allow several seconds for the monitor to recognize the USB signal. Do not disconnect or reconnect the USB cable while the signal is being recognized.

Connecting to a Computer with HDMI

- Please use an HDMI cable with the HDMI logo.
- It may take a moment for the signal to appear after turning on the computer.
- Some display cards or drivers may not display an image correctly.
- If the monitor's power is turned on after a connected computer is turned on, sometimes an image is not displayed. In this case, please turn off the computer then turn it on again.

Connecting a USB device

USB: USB downstream port (USB Type-A).

Connect USB devices such as a portable hard drive, USB flash drive, USB keyboard and mouse, Active pen charger, etc.

- Please make sure the connector shape and orientation is correctly aligned when connecting the USB device or cable.
- Please refer to the specifications page for power supply information (see [page 35](#)).
- When you use the USB port for power supply, please use a USB cable that supports 500mA.
- Do not bind the USB cable. It may trap heat and start a fire

Input Detection Function

The input detection function*1 is enabled by default on this monitor.

- When a signal is connected to an input terminal, the terminal is automatically switched to the corresponding terminal.
- If a signal is already connected to a different input terminal, the monitor switches to the last terminal connected to a signal.
- If the signal currently being displayed is not input anymore (disconnection, computer shutdown, etc.), the monitor switches automatically to the terminal*2 displayed previously.

*1: The input detection function can be turned on and off in [Input Detect] under [Other Settings] in [Advanced Setting].

*2: If no signal is input to the previously displayed terminal, the monitor switches to the terminal displayed before this one if a signal is input. If no signal is input to both terminals, the terminals are not switched.

Example

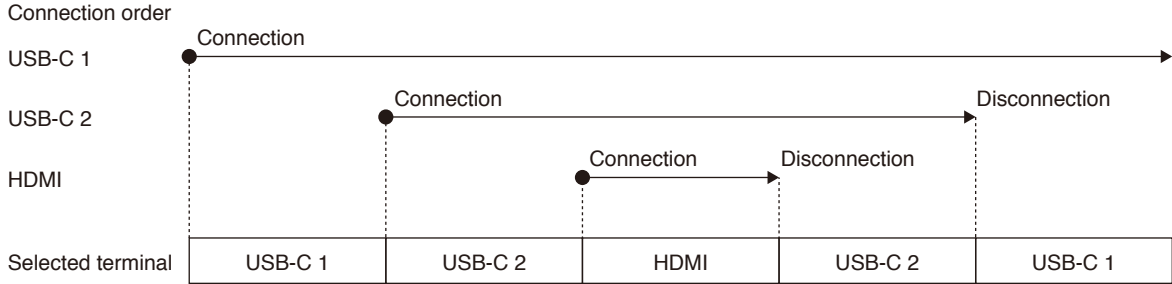

About the Audio Settings of the Computer

When the monitor is connected to a computer, two speaker devices are recognized.

Select USB Speaker (WD551 Audio) in the audio settings of the computer.*1

USB Speaker (WD551 Audio)
 WD551 (-----*2)

*1: If WD551(-----) is selected, the sound mute status display may not match between the monitor and the computer.

*2: The content of the "-----" section differs depending on the computer you are using.

NOTE:

The monitor includes two audio modes, one suitable for conferences and the other suitable for watching videos. These modes switch automatically depending on the microphone selection on the computer.

When the monitor microphone (Microphone(WCD Audio)) is selected in the computer audio settings:

The sound is played in mono, and Echo Cancel is enabled.

This setting is suitable for videoconferences.

When a microphone other than the monitor microphone is selected in the computer audio settings:

The sound is played in stereo, and the subwoofer is enabled.

This setting is suitable for video playback.

Operation Modes

Operation mode	Status
Power on	All functions can be used.
Screen off	The same as with power on, but the screen is turned off. The sensor function is enabled.*1
Standby	The screen is turned off, and the sensors are disabled. The power consumption is reduced.

See [page 35](#) for the power consumption in each mode.

*1: The sensor function is disabled when the monitor is in standard mode.

Switching of the operation modes (when in the WCD mode)

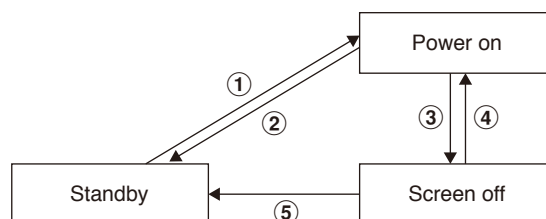

The operation modes switch as shown below.





① Standby → Power on

- Press the  button on the monitor or the remote control in standby mode.



② Power on → Standby

- Press the  button on the remote control.*2
- Hold down the  button on the monitor for 2 seconds or more.*2



③ Power on → Screen off

- There is no video signal, and the presence sensor does not detect anyone.*3*4
- Press the  button on the remote control.
- Press the  button on the monitor.

④ Screen off → Power on

- A video signal is active or the presence sensor detects a person.
- Press the  button on the remote control.
- Press the  button on the monitor.
- Touch the screen.

⑤ Screen off → Standby*4

- Press the  button on the remote control.
- Hold down the  button on the monitor for 2 seconds or more.

*2: A confirmation message is displayed, and switching to the standby mode can be canceled.

*3: When no video signal is input for the set time (see [page 28](#)) and the presence sensor does not detect anyone for 30 seconds or more.

*4: Switches to the standby mode about 10 seconds after the operation.

NOTE: If the standard mode is set (see [page 29](#)), the monitor switches to standby if no video signal is input in the power on state.

OSD (On-Screen Display) Controls

Swipe your finger up from the bottom of the screen or press the input button on the remote control to open the OSD Menu.

OSD Settings

General setting

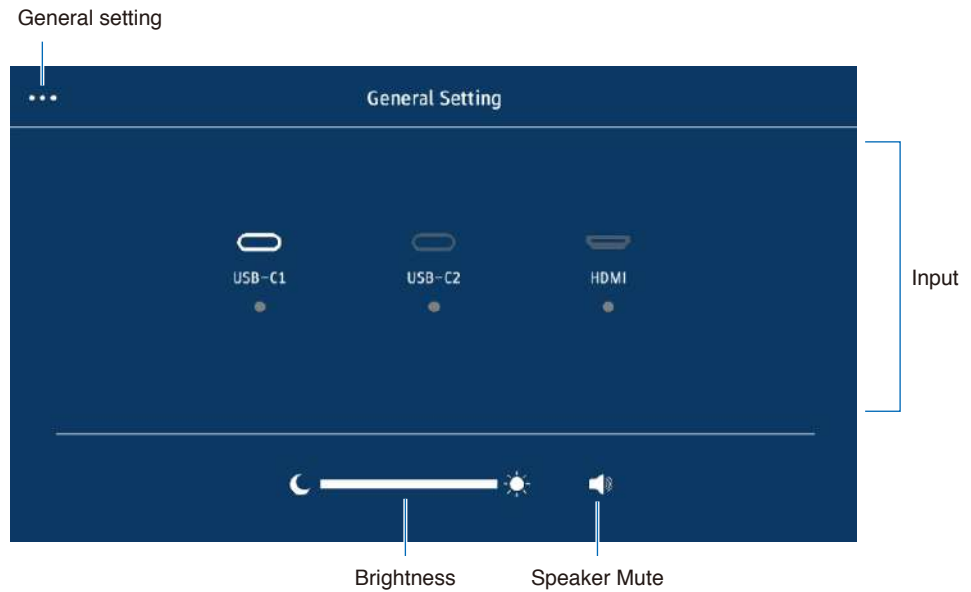

Menu	Function	
General setting(...)	Open the General setting menu.	
Input	USB-C 1	Select the USB-C 1 input.
	USB-C 2	Select the USB-C 2 input.
	HDMI	Select the HDMI input.
Brightness	Adjusts the overall image and background brightness.	
Speaker Mute	Toggle mute / unmute the speaker.*	

* Depending on the output device settings, the mute status and OSD display may not match. In this case, set the output device to [USB Speaker (WD551 Audio)] from the computer sound settings.

General Setting

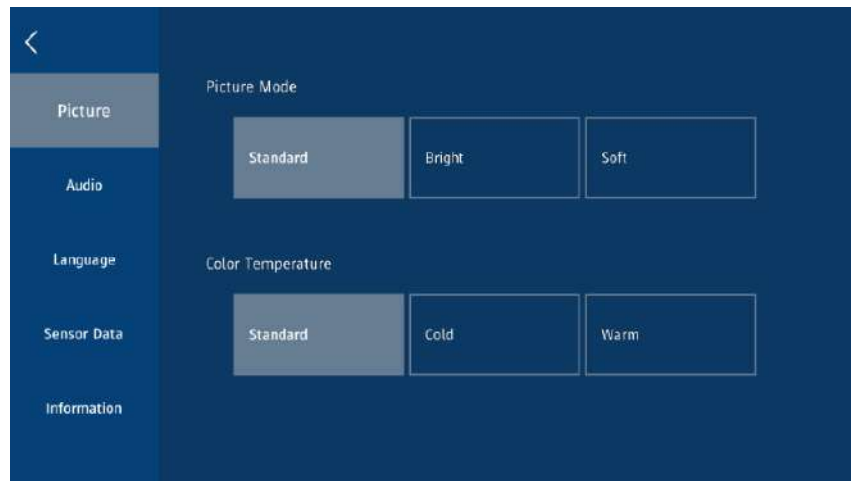

Menu	Function		
Picture	Picture Mode	Provides pre-configured picture settings suitable for environments where this device may be used.	
		Standard	For general Windows environment and monitor default setting.
		Bright	Higher brightness setting.
		Soft	Soft setting.
	Color Temperature	Adjusts the color temperature of the entire screen.	
		Standard	Standard setting
		Cold	Bluish white
Warm	Reddish white		
Audio	Volume	Increase or decrease output volume level.	
	Speaker Mute	<input type="checkbox"/>	Return the sound volume to the previous level.
		<input checked="" type="checkbox"/>	Turn off the sound.
	Mic Mute	<input type="checkbox"/>	Turn on the microphone input.
<input checked="" type="checkbox"/>		Turn off the microphone input.	
Language	Language	Set display language, Keyboard and input method. Language: English, Deutsch, Français, Italiano, Español, Svenska, Русский, 中文, 日本語	
Sensor Data	Show the ambient temperature, humidity, Air quality, Light, and presence sensor status.		
Information	Shows the monitor information, input signal information and system information. The advanced menu can be opened from here.		

OSD Settings

Advanced Setting

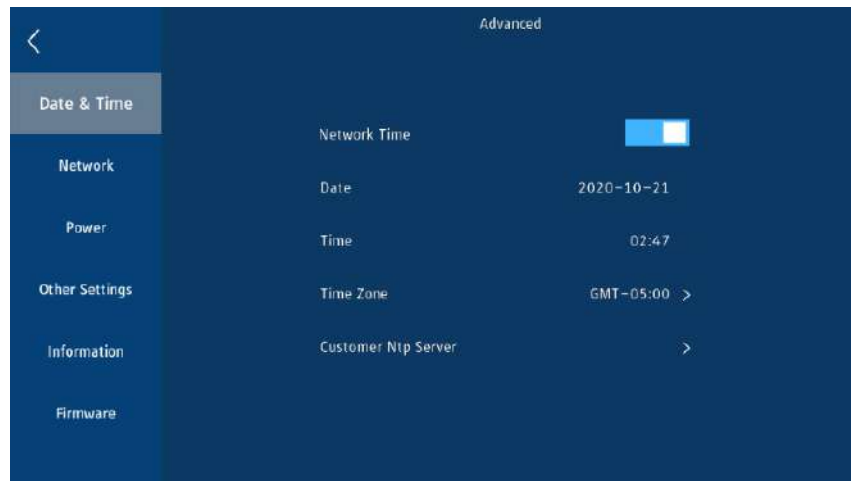

Menu	Function		
Data & Time	Network Time	<input type="checkbox"/> Set the time manually.	
		<input checked="" type="checkbox"/> Get time automatically from network.	
	Data	Set the year, month, and day. (YYYY, MM, DD)	
	Time	Set the current time.	
	Time Zone	Select the local time zone to use the monitor.	
NETWORK	DHCP	<input type="checkbox"/> Configure the network settings manually. Contact the Network Administrator for this information.	
		<input checked="" type="checkbox"/> The IP address is automatically obtained from the DHCP server.	
	IP Address	Set the IP address for the monitor connected to the network when <input type="checkbox"/> is selected for [DHCP].	
	Subnet Mask	Set the subnet mask data for the monitor connected to the network when <input type="checkbox"/> is selected for [DHCP].	
	Default Gateway	Set the default gateway for the monitor connected to the network when <input type="checkbox"/> is selected for [DHCP].	
	Auto DNS	<input type="checkbox"/> Manually enter the IP address of the DNS server which is connected to the monitor.	
		<input checked="" type="checkbox"/> The DNS server which is connected to the monitor will automatically assign its IP address.	
	DNS	Enter the DNS server settings of the network connected to the monitor.	
	MAC Address	Shows the monitor's [MAC Address].	
	Apply	Apply the network settings.	
Power	Auto Power ON	Signal Detected <input type="checkbox"/> The monitor does not automatically turn on when a signal is input.	
		Signal Detected <input checked="" type="checkbox"/> The monitor turns on automatically when a signal is input.	
	Presence Sensor	<input type="checkbox"/> The monitor does not turn on automatically even if a person is detected by the motion sensor.	
		<input checked="" type="checkbox"/> The monitor automatically turns on when a person is detected by the motion sensor.	
	AUTO STANDBY	Off	Maintain Power ON state.
		5, 15, 30 Minutes	If there is no signal for the set time, the device shifts to the Screen off*. * In WCD Mode. It shifts to the standby status in Standard Mode.

Other Settings	WCD Mode	WCD Mode	Enables the function as a Windows collaboration display.
		Standard Mode	Disables the function as a Windows collaboration display. Reduces power consumption during standby.
	Input Detect	Auto	The currently displayed input terminal switches automatically when a signal is connected to another input terminal. If the last connected terminal is unplugged, the settings will return to the previously displayed terminal.
		Manual	The input terminal does not switch automatically.
	Source Select	Enable	⏪ button on the front is active.
		Disable	⏪ button on the front is disabled.
	Default Input	OFF	At startup, the terminal at the time of power OFF is selected.
		USB-C 1	At startup, the USB-C1 terminal is selected.
		USB-C 2	At startup, the USB-C2 terminal is selected.
		HDMI	At startup, the HDMI terminal is selected.
	Aspect	Normal	Display with standard aspect ratio.
		1:1	Displays all pictures in 1:1 aspect ratio.
	EDID	60Hz	Video signals with a refresh rate of 50Hz or less will not be displayed.
		Auto	Displays video signals with a refresh rate of 23-60Hz.
	Overscan	OFF	Displays almost 100% of the input signal area. Depending on the signal, noise may appear on the edges of the screen.
		ON	Displays the area of about 95% of the input signal.
	Startup Logo	Logo	The NEC logo is displayed at startup.
		Black	A black screen is displayed at startup.
		Blue	A blue screen is displayed at startup.
	Information	Information such as firmware version and usage time.	
Firmware	Perform a firmware reset or update.		

* Use the number buttons on the remote controll to set the IP address, subnet mask, default gateway, DNS of the network items.

External Control

Controlling the Monitor via RS-232C

This LCD monitor can be controlled by connecting a personal computer with an RS-232C terminal.

Functions that can be controlled by a personal computer are:

- Power ON or standby.
- Switching between input signals.
- Sound Mute ON or OFF.

Connection

LCD Monitor + computer.

- Please turn off the monitor's main power when connecting a computer to the monitor.
- Please turn on the connecting computer first then turn on the monitor's main power.
If you turn on the computer and monitor in reverse order, the com port may not work.

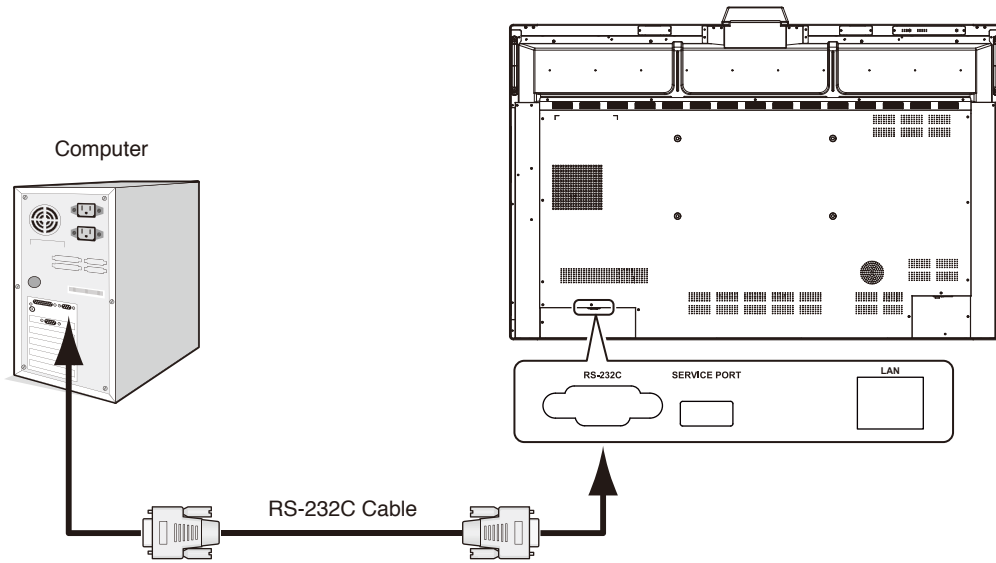

NOTE:

- If your computer is equipped only with a 25-pin serial port connector, a 25-pin serial port adapter is required. Contact your supplier for details.
- For the pin assignment, please see "2) RS-232C input/output" on page 31.

To control the monitor via commands sent from a computer connected with an RS-232C cable, please use the control command. Instructions for the control command can be found in the Control Command Diagram (see on the next page).

1) Interface

PROTOCOL	RS-232C
BAUD RATE	9600 [bps]
DATA LENGTH	8 [bits]
PARITY	NONE
STOP BIT	1 [bit]
FLOW CONTROL	NONE

This LCD monitor uses RXD, TXD and GND lines for RS-232C control.

The reverse type cable (null modem cable) (not included) should be used for RS-232C control.

2) PIN ASSIGNMENT

RS-232C input/output

Pin No	Name
1	NC
2	RXD
3	TXD
4	NC
5	GND
6	NC
7	NC
8	NC
9	NC

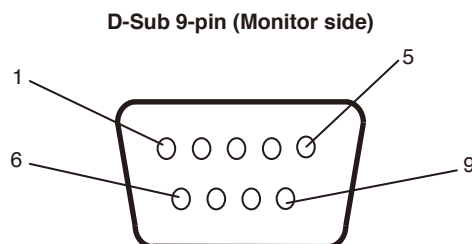

This LCD monitor uses RXD, TXD and GND lines for RS-232C control.

Control command

For other commands, please see "External_Control.pdf" file on the NEC website.

Function (Monitor ID = 1)	Code Data
Power ON	01 30 41 30 41 30 43 02 43 32 30 33 44 36 30 30 30 31 03 73 0d
Power OFF	01 30 41 30 41 30 43 02 43 32 30 33 44 36 30 30 30 34 03 76 0d
Input Source Select HDMI input	01 30 41 30 45 30 41 02 30 30 36 30 30 30 31 31 03 72 0d
Input Source Select USB-C1 input	01 30 41 30 45 30 41 02 30 30 36 30 30 30 38 39 03 73 0d
Input Source Select USB-C2 input	01 30 41 30 45 30 41 02 30 30 36 30 30 30 38 41 03 0B 0d
Sound Mute ON	01 30 41 30 45 30 41 02 30 30 38 44 30 30 30 31 03 09 0d
Sound Mute OFF	01 30 41 30 45 30 41 02 30 30 38 44 30 30 30 32 03 0A 0d

Troubleshooting

No picture

- The signal cable should be completely connected to the display card/computer.
- The display card should be completely seated in its slot.
- Check the main Power Switch, it should be in the ON position.
- Power Switches for the monitor and computer should be in the ON position.
- Make sure that a supported resolution has been selected on the display card or system being used. If in doubt, please refer to the user's manual of the display card or system to change the resolution.
- Check the monitor and your display card with respect to compatibility and recommended signal timings.
- Check the signal cable connector for bent or pushed-in pins.
- Check for HDCP (High-bandwidth Digital Content Protection) content. HDCP is a system for preventing illegal copying of video data sent over a digital signal. If you are unable to view material via the digital inputs, this does not necessarily mean that the monitor is not functioning properly. With the implementation of HDCP, there may be cases in which certain content is protected by HDCP and might not be displayed due to the decision/intention of the HDCP community (Digital Content Protection, LLC).
- If you unplug the signal cable when starting the computer, images may not be displayed. Turn off the monitor and the computer and then connect the signal cable and turn on the computer and the monitor.
- When using a USB Type-C cable for connecting a computer to the monitor, please check that the connected computer's port complies with DisplayPort Alt Mode.
- When using a USB Type-C cable for connecting a computer to the monitor, check that the USB Type-C cable complies with SuperSpeed USB (USB 3.2 Gen 1).
- Refer to the NEC Display Solutions website for information about tested computers and USB Type-C cables for connecting to the USB-C port on the monitor.

Power Button does not respond

- Unplug the power cord of the monitor from the AC outlet to turn off and reset the monitor.
- Check the main Power Switch on the monitor.

Image persistence

- Please be aware that LCD Technology may experience a phenomenon known as Image Persistence. Image Persistence occurs when a residual or "ghost" image of a previous image remains visible on the screen. Unlike CRT monitors, the image persistence of LCD monitors is not permanent, but single still image being displayed for a long period of time should be avoided. To alleviate image persistence, put the monitor into Screen off or standby via remote control or turn the monitor's main power off for as long as the previous image was displayed. For example, if an image was on the monitor for one hour and a residual image remains, the monitor should be in Screen off, standby or main power off for one hour to erase the image.

NOTE: As with all personal display devices, NEC DISPLAY SOLUTIONS recommends displaying moving images, using a moving screen saver, or changing still images at regular intervals whenever the screen is idle, or turning it into standby or main power off of the monitor when not in use.

The image is blinking

- If you use a signal repeater or distributor or a long cable, this may cause image roughness or blink for a moment. In this case please connect the cable to the monitor directly without using a repeater or a distributor, or replace the cable with a higher quality cable. Using a twisted pair extender may cause image roughness depending on the environment where the monitor is in or the cable you are using. For further information please ask your supplier.
- Some HDMI cables may not show a correct image. If input resolution is 1920 x 2160, 3840 x 2160 or 4096 x 2160, please use an HDMI cable which is approved to support 4K resolution.

4k display is not possible

- If the connected computer does not support 3840 x 2160 60Hz, the resolution may decrease depending on the monitor settings. By setting "EDID" to "Auto" from "Other settings" in "Advanced settings", it is possible to display at 3840 x 2160 30Hz.

The image is unstable, unfocused or swimming is apparent

- The signal cable should be completely attached to the computer.
- Check the monitor and your display card with respect to compatibility and recommended signal timings.
- If text looks garbled, use a 60 Hz refresh rate.
- The image may be distorted when turning the power on or changing the settings.

LED on the monitor is not lit (no blue or red color can be seen)

- The main Power Switch should be in the ON position and the power cord should be connected.
- Make certain the computer is not in a power-saving mode (touch the keyboard or move the mouse).

LED colors, except for blue, are blinking or glowing

- The monitor could be in standby. Press the power on button on the remote control or press the power button on the monitor.

No Sound

- Check to see if MUTE is activated. Use the remote control to enable or disable the Mute function.
- Check to see if VOLUME is set to a minimum.
- Check to see if the computer supports an audio signal through HDMI. If unsure, contact your supplier.

The USB hub does not operate

- Refer to your USB device's user manual to verify its compatibility with the specifications of this product's USB hub.
- If you are using an HDMI with USB connection setup with the monitor, make sure the USB cable is properly connected to both the monitor and the computer.
- Check if the USB upstream port on the monitor is connected to the USB downstream port on the computer. Please make sure the computer is on.
- When connecting with a USB Type-C cable, do not connect the USB-B terminal to a computer.

The Remote Control is not functioning

- Check the batteries status of the Remote Control.
- Check if the batteries are inserted correctly.
- Check if the Remote Control is pointing at the remote control sensor of the monitor.
- The remote control system may not function when direct sunlight or strong illumination strikes the remote control sensor of the monitor, or when there is an object in the path.

Interference in TV

- Check components for shielding, move away from the monitor if necessary.

RS-232C control is not available

- Check RS-232C (reverse type) cable.

The monitor goes into standby / Screen off automatically

- Please check "OFF TIME" setting.*1
- If there is no signal and the presence sensor does not detect a person, the mode shifts to Screen off.*2
- In Standard mode, the Auto standby setting cannot be turned off.

Presence sensor does not respond

- There is an undetectable area near the monitor.
- The Presence sensor becomes less sensitive at room temperature above 30 ° C / 86 ° F. Please check the room temperature.

Wrong temperature sensor value

- The temperature displayed on this unit is the temperature near the temperature sensor. It does not always match room temperature.

Air quality sensor value is not displayed

- The air quality sensor preheats for about 2 minutes after starting, so the measured value is not displayed. Please check again after preheating.

Either light vertical or horizontal stripes may appear, depending on the specific image pattern. This is not a product fault or degradation.

*1 The Auto standby setting cannot be turned off in standard mode.

*2 In WCD mode, it shifts to Screen off, and in standard mode, it shifts to standby.

Specifications - Compatible signal list

The signal settings (Auto, 60Hz) can be changed with the OSD. The default setting is 60Hz.

Resolution	Scanning frequency		HDMI (60 Hz)		USB Type-C	
	Horizontal	Vertical	Auto	60 Hz	Auto	60 Hz
640 x 480	31.5 kHz	60 Hz	YES	YES	YES	YES
800 x 600	37.9 kHz	60 Hz	YES	YES	YES	YES
1024 x 768	48.4 kHz	60 Hz	YES	YES	YES	YES
1280 x 720	45 kHz	60 Hz	YES	YES	YES	YES
1280 x 768	47.8 kHz	60 Hz	YES	YES	YES	YES
1280 x 960	60 kHz	60 Hz	YES	YES	YES	YES
1280 x 1024	64 kHz	60 Hz	YES	YES	YES	YES
1366 x 768	47.7 kHz	60 Hz	YES	YES	YES	YES
1440 x 900	55.9 kHz	60 Hz	YES	YES	YES	YES
1680 x 1050	65.3 kHz	60 Hz	YES	YES	YES	YES
1920 x 1080	67.5 kHz	60 Hz	YES	YES	YES	YES
3840 x 2160	67.4 kHz	30 Hz	YES	NO	YES	NO
3840 x 2160	135 kHz	60 Hz	YES	YES	YES	YES
4096 x 2160	135 kHz	60 Hz	YES	YES	YES	YES

* Some display cards may not be able to support the required resolution for proper image reproduction.

Specifications - WD551

Product Specifications

LCD Module	Pixel Pitch: Resolution: Color: Brightness(max): Contrast Ratio: Viewing Angle:	0.315 mm x 0.315 mm UHD 3840 x 2160 (pixels) (R + G + B design) 1.07 G(8 bits + FRC) min: 350 cd/m ² typ: 400 cd/m ² Brightness with AG Glass 1200:1 178° (Horizontal&Vertical)	
Frequency	Horizontal: Vertical:	min:30 kHz typ: 67.5 kHz [Normal mode] / 135 kHz [WCD mode] max:135 kHz min:23 Hz [Normal mode] / 50 Hz [WCD mode] typ:30 Hz [Normal mode] / 60 HZ [WCD mode] max:76 Hz	
Pixel Clock		25.0-600 MHz (DisplayPort by USB) 25.0-600 MHz (HDMI)	
Viewable Size		1209.6 (H) x 680.4 (V)	
Input Signal			
DisplayPort	USB-C1 Connector	Digital RGB, YUV	DisplayPort V1.4 (3840 x 2160 @ 60Hz, HDCP2.2/1.3)
	USB-C2 Connector	Digital RGB, YUV	DisplayPort V1.4 (3840 x 2160 @ 60Hz, HDCP2.2/1.3)
HDMI	HDMI Connector	Digital RGB, YUV	HDMI (3840 x 2160 @ 60Hz, HDCP2.2/1.4)
AUDIO			
AUDIO Input	USB-C1 Connector	Digital Audio	PCM 32, 44.1, 48 KHz (16/20bit), 2ch
	USB-C2 Connector	Digital Audio	PCM 32, 44.1, 48 KHz (16/20bit), 2ch
	HDMI Connector	Digital Audio	PCM 32, 44.1, 48 KHz (16/20bit), 2ch
AUDIO Output			N/A
Speaker Output			Internal Speaker 12 W + 12 W (Sterreo) + 15 W (Subwoofer)
Control	RS-232C IN: LAN:	9 Pin D-sub [DTE type] RJ45 10BASE-T/100BASE-TX x 1	
USB Hub	USB3.0	Side port (Type-A) x 2 Side port (Type-B) x 1	
Power Supply		1.7 - 4.2 A @ AC 100 - 240 V 50/60 Hz 1.7 A @ 240 V 4.2 A @ 100 V	
Power Consumption	(Maximum)	370.5 W	
Operational Environment	Temperature: Humidity: Altitude:	0~40°C / 32~104°F 10~90% 5000 m (16404 ft)	
Storage Environment	Temperature: Humidity:	-20~60°C / -4~140°F 90% (Over 40°C / below 60%)	
Dimension		1266.0 x 856.8 x 86.5 mm / 49.84 x 33.73 x 3.41 inches (without wall mount)	
Weight		31.20 kg (68.78 lbs)	
VESA compatible mounting interface		400 mm x 200 mm (M8, 4 Holes) (not VESA)	
Power Management		N/A	
Protective glass	Material: Thickness: Surface treatment: Transparency: Haze: Surface hardness: Impact resistance:	Tempered glass 3.0 mm Anti-Glare+Anti-Fingerprint coating ≥88% 4~10% 7H Ball drop test: 500 g steel ball, 1.2 m High	

Manufacturer's Recycling and Energy Information

NEC DISPLAY SOLUTIONS is strongly committed to environmental protection and sees recycling as one of the company's top priorities in trying to minimize the burden placed on the environment. We are engaged in developing environmentally-friendly products, and always strive to help define and comply with the latest independent standards from agencies such as ISO (International Organisation for Standardization) and TCO (Swedish Trades Union).

Disposing of your old NEC product

The aim of recycling is to gain an environmental benefit by means of re-use, upgrading, reconditioning or reclamation of material. Dedicated recycling sites ensure that environmentally harmful components are properly handled and securely disposed. To ensure the best recycling of our products, **NEC DISPLAY SOLUTIONS offers a variety of recycling procedures** and gives advice on how to handle the product in an environmentally sensitive way, once it has reached the end of its life.

All required information concerning the disposal of the product and country-specific information on recycling facilities can be found on our following websites:

<https://www.nec-display-solutions.com/p/greenvision/en/greenvision.xhtml> (in Europe),

<https://www.necdisplay.com> (in USA).

Energy Saving

This monitor features an advanced energy saving capability.

For additional information visit:

<https://www.necdisplay.com/> (in USA)

<http://www.nec-display-solutions.com/> (in Europe)

<https://www.nec-display.com/global/index.html> (Global)

For ErP requirement /

Except for conditions below

[Advanced setting] in [Other settings] in [WCDmode] is set to [WCD mode]

Power consumption: 0.5 W or less

Time for power management function: 5 min. (Default setting)

WEEE Mark (European Directive 2012/19/EU and amendments)



Disposing of your used product: In the European Union

EU-wide legislation as implemented in each Member State requires that used electrical and electronic products carrying the mark (left) must be disposed of separately from normal household waste. This includes monitors and electrical accessories, such as signal cables or power cords. When you dispose of such products, please follow the guidance of your local authority or ask the shop where you purchased the product, or if applicable, follow applicable legislation or agreement you may have. The mark on electrical and electronic products may only apply to the current European Union Member States.

Outside the European Union

If you wish to dispose of used electrical and electronic products outside the European Union, please contact your local authority and ask for the correct method of disposal.



For EU: The crossed-out wheeled bin implies that used batteries should not be put to the general household waste! There is a separate collection system for used batteries, to allow proper treatment and recycling in accordance with legislation.

According to EU directive 2006/66/EC and amendments, the battery can't be disposed improperly. The battery shall be separated to collect by local service.

Trademarks

Microsoft®, Windows® and Microsoft Teams are either registered trademarks or trademarks of Microsoft Corporation in the United States and/or other countries.

NEC is a registered trademark of NEC Corporation.

MultiSync is a trademark or registered trademark of Sharp NEC Display Solutions, Ltd. in Japan and other countries.

The terms HDMI and HDMI High-Definition Multimedia Interface, and the HDMI Logo are trademarks or registered trademarks of HDMI Licensing Administrator, Inc. in the United States and other countries.

DisplayPort™ and the DisplayPort™ logo are trademarks owned by the Video Electronics Standards Association (VESA®) in the United States and other countries.

USB Type-C and USB-C are a registered trademark of USB Implementers Forum.

All other brands and product names are trademarks or registered trademarks of their respective owners.



GPL/LGPL Software Licenses

The product includes software licensed under GNU General Public License (GPL), GNU Lesser General Public License (LGPL), and others. For more information on each software, see “readme.pdf” inside the “about GPL&LGPL” folder on the NEC website.