

**T E N W A Y S**

**CGO600 Pro Manual**

energized urban ride

# CGO600 Pro



# Useful information.

## ● Find your language

Scan the QR code to access the user manuals in German/ Dutch/ French/ Italian/ Spanish.



---

User manuals in English/ German/ Dutch/ French/ Italian/ Spanish are also available inside the TENWAYS App.

## ● Unlock Your Reward

Join the Green Rider Club and unlock your exclusive rewards!



---

Subscribe to the TENWAYS Newsletter for valuable tips and the latest news!



# Index

## Assemble your TENWAYS e-bike

1.	Unwrap your TENWAYS e-bike	06
2.	Install the rear mudguard and kickstand	08
3.	Install the handlebar	10
4.	Remove the front wheel from the bundle	11
5.	Pre-install the quick release	12
6.	Install the front wheel	13
7.	Install the front mudguard	16
8.	Install the battery	17
9.	Install the pedals	18
10.	Adjust the height of the saddle cushion	19
11.	Install the reflectors	20

## Display operations

1.	Main interface	22
2.	Button Definitions	25
3.	Function Operations	26
4.	User Settings	28
5.	Data Clean	31
6.	Error Information	32

## **Bike usage**

- |    |   |    |
|----|---|----|
| 1. | How to connect your e-bike to the TENWAYS App | 34 |
| 2. | Before your first ride                        | 35 |
| 3. | Routine maintenance                           | 36 |
| 4. | Frame code                                    | 39 |

## **Important reminders**

- |    |          |    |
|----|----------|----|
| 1. | Warranty | 42 |
| 2. | FAQ      | 43 |
| 3. | Warnings | 44 |

# Assemble your TENWAYS e-bike.



# 1. Unwrap your TENWAYS e-bike

Take your bike, tool box, and battery pack out of the box. Remove and recycle all wrapping materials.

## ● Bike



## ● Battery pack



## ● Tool box



# ToolBox checklist

Here is a list of items you can find in the toolbox:

## ● Tools



3 mm  
Hex Key



4 mm  
Hex Key



5 mm  
Hex Key



Phillips Head  
Screwdriver



10 mm  
Wrench



15 mm  
Wrench

## ● Accessories

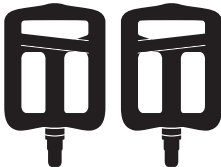

Bicycle Pedals



Charger

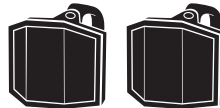

Front & Rear  
reflectors



Rear light



# 2. Install the rear mudguard and kickstand

Use a 4 mm Hex Key to fix the rear mudguard supports to both sides of the seat stay.



Fix the kickstand to the frame with the 5mm Hex Key; the torque should be 9Nm-12Nm.

Adjust the length of the kickstand with the 4mm Hex Key (it is recommended to adjust the length of the kickstand to the maximum); the torque should be 5Nm-7Nm.

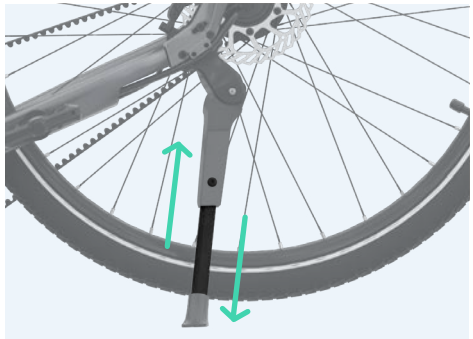

Use the kickstand to support your e-bike during the next installation steps.



# 3. Install the handlebar

Hold the front fork firmly and turn the stem so it faces forward, and then remove the front attachment with a 4mm Hex Key.

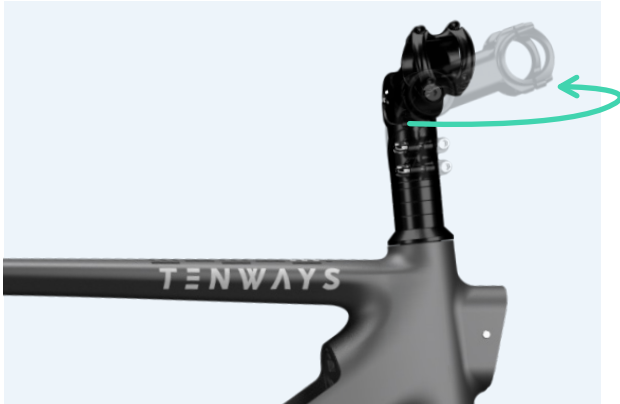

Put the handlebar into the stem slot, adjust the handlebar so that its center and the slot's center are aligned, and then use the 4 mm Hex Key to tighten the screws in a diagonal pattern as shown in the picture below.

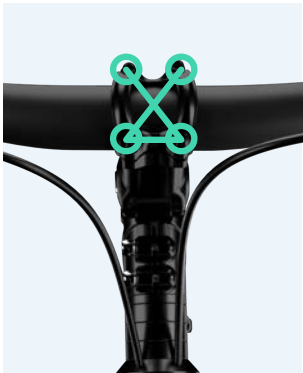

# 4. Remove the front wheel

Remove the front wheel from the bundle and then detach the plastic protective covers on both sides of the wheel.

**Attention:**

You must remove the front wheel in the direction of the spokes to avoid scratching them.



**Important note**

Hold your e-bike with the kickstand down to facilitate the next installation steps.

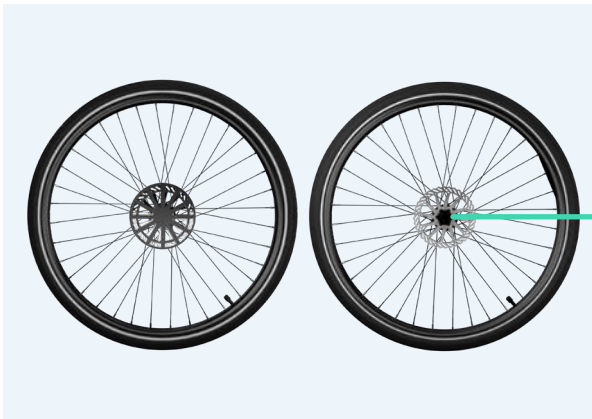

# 5. Pre-install the quick release

Loosen the nut and remove the quick release lever.

Remove all wrapping material from the quick release.

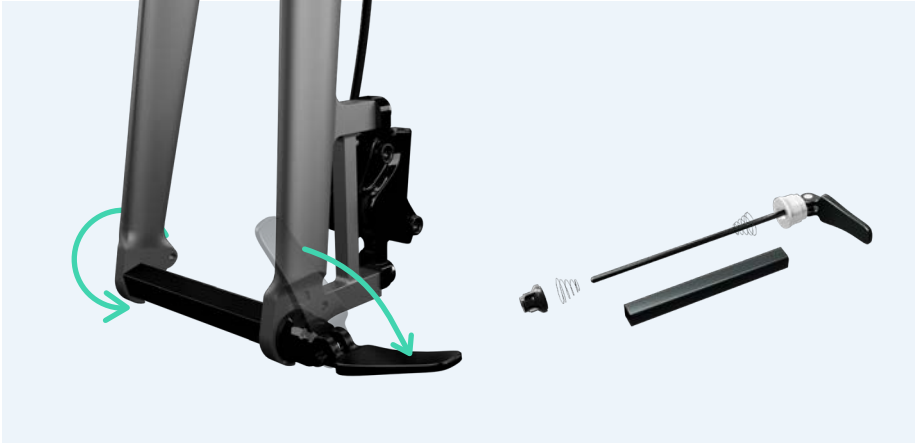

Install the quick release on the front wheel in the direction shown in the figure, and then tighten the nut.



### Attention

When installing the quick release spring, you should ensure that the orientation is the same as when it was removed.

# 6. Install the front wheel

## Step 1

Set the quick release lever to the open position, and then remove the protective sheets from the brake clamps.

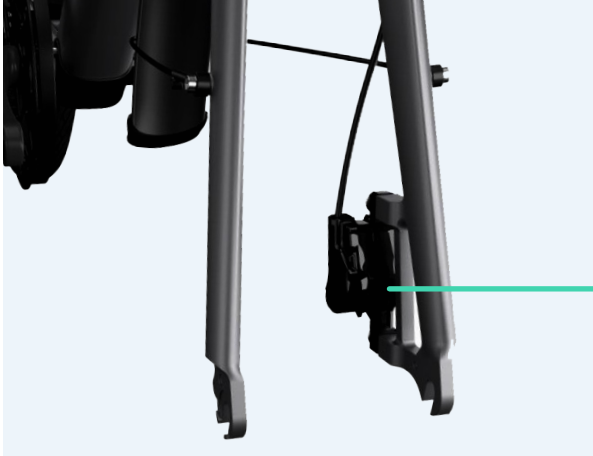

protective sheets

Install the front wheel; make sure that the brake disc is in the middle of the brake clamps.



**Step 2**

Tighten the quick release nut, and then turn it to the closed position as shown in the figure.



**Step 3**

Press the brake and push the bike back and forth to check if the front wheel wobbles. If so, please repeat step 2 until you feel enough resistance when closing the quick release lever.

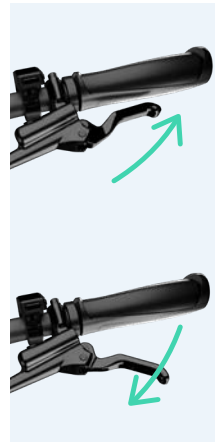

#### Step 4

Turn the front wheel by hand and check if there are any signs of scraping.

#### Step 5

If yes, please follow the steps below to make adjustments:

1. Use the 5 mm Hex Key to slightly loosen the mounting screws of the brake clamps to make sure that they can move slightly.
2. Press the front brake 3 to 5 times.
3. Hold the front brake and tighten the mounting screws of the brake clamps.
4. Turn the front wheel by hand and listen for the sound of friction.
5. If there is friction, loosen the mounting screws of the brake clamps.
6. Manually adjust the position of the brake clamps to center the disc, and then re-tighten the screws.

#### Attention

As the above steps are very important, please kindly follow them carefully.



5 mm Hex Key



#### Note

The protective sheet on the brakes should be kept for future use.



# 7. Install the front mudguard

Use a phillips screwdriver to pre-lock the mudguard lugs to the front fork.

Use a 4 mm Hex Key to fix the mudguard supports to both sides of the front fork.



Phillips Head Screwdriver



4 mm Hex Key

Adjust the lengths of the left and right mudguard supports to the appropriate positions, use a 3 mm Hex Key to lock the supports, and then tighten the pre-lock screws of the mudguard lugs.



3 mm Hex Key

# 8. Install the battery

Tilt and clip the upper end of the battery into place slot, and then press the lower end. You will hear a click when the battery is firmly seated.



Battery keys

# 9. Install the pedals

Distinguish between the left and right pedals. The right and left pedals are marked by an R and an L respectively. The right pedal is used for the side with the crankset, while the left one is used for the other side.

Tighten the right pedal clockwise and the left pedal counterclockwise. Please stop tightening the pedals if you feel a lot of resistance. If this happens, align and reinstall the pedals.

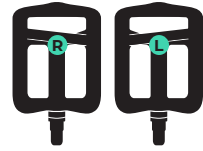

Bicycle Pedals



15 mm Wrench

## Right pedal

Tighten the right pedal clockwise.



## Left pedal

Tighten the left pedal counterclockwise.



## Attention

Do not force the installation if you feel a lot of resistance.

# 10. Adjust the height of the saddle cushion

Open the seat post clamp, adjust the saddle cushion to a suitable height, and then lock the clamp.



**Attention**

The height of the seat post should not exceed the marked safety line.



# 11. Install the reflectors

Distinguish between the front reflector and the rear one. The front reflector is white, while the rear one is red.

Use the Phillips head screwdriver to install the rear reflector to the seat post and the front one to the handlebar.



Phillips Head Screwdriver

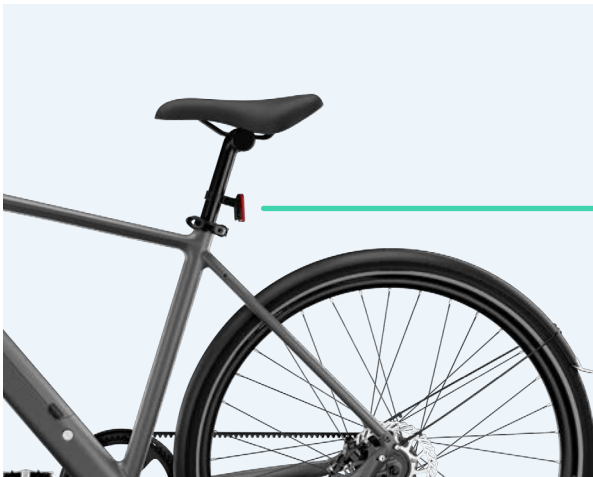

# Display Operations.



# 1. Main Interface

## 1.1. Welcome Screen

The Welcome Screen will be displayed for 2 seconds after you turn the display on



## 1.2. Main Interface

- 1) **PAS:** Your e-bike comes with 4 assist levels (from low to high: 0, 1, 2, and 3) and a WALK mode.
- 2) **KM/H:** This represents your current riding speed.
- 3) **KM:** Accurate to one decimal place, the maximum trip value is 999.9.
- 4) **Power indicator:** The remaining battery level (1 to 5) or the under-voltage status will be displayed here. An icon will flash if the device is under-voltage.
- 5) **Front light indicator:** The icon will be displayed when the front light is on.
- 6) **Bluetooth indicator:** The icon will be displayed when your e-bike is connected to a mobile phone.



### 1.3. Functions Interface (I)

- 1) **AVG:** This represents the average riding speed.
- 2) **MAX:** This represents the maximum riding speed.
- 3) **TRIP:** This represents the distance your e-bike has traveled in its current journey. The maximum value is 999.9.



### 1.4. Functions Interface (II)

- 1) **RANGE:** This refers to the remaining distance that the battery can sustain.
- 2) **TOTAL:** This refers to the total distance your e-bike has traveled so far. The maximum value is 9999.9.  
The remaining display content is the same as what you can see on the main interface.





## 1.5. Settings Interface

- 1) **Settings interface:** This is to remind you that you're currently on the settings interface.
- 2) **Exit option and selection brackets:** You will exit the settings interface and return to the main interface if you select this option and short press the Function button. The [ ] represents the currently selected menu option.
- 3) **Unit:** The speed and distance unit settings.
- 4) **Wheel:** The information about the wheel diameter.
- 5) **Password:** You can change or disable the password (by default, it's disabled).
- 6) **Auto off:** This refers to the duration after which the display will turn off automatically (by default, it's 5 minutes).
- 7) **Speed limit information:** The maximum speed limit.
- 8) **Battery:** The information about the battery.
- 9) **Hardware information:** Information about the hardware.
- 10) **Reset:** You can restore factory settings with this option.

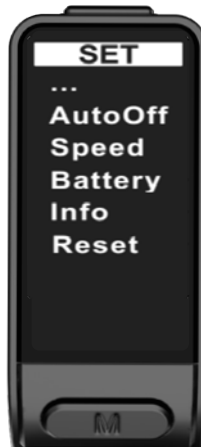

# 2. Button Definitions

 Power button



 Function button



 Up button



 Down button



# 3. Function operations

## 3.1. On / Off

### Maintaining a normal connection between display and controller

Long press power button (2 seconds) when the display is off; the display will turn on and show the main interface. Long press power button (2 seconds) when the display is on to turn off. The display will automatically turn off if no display operations are made for 5 minutes while the speed is 0.

## 3.2. Switching assist levels

Press **Up button** or **Down button** to switch levels and change the assist mode; the e-bike comes with 5 modes (0, 1, 2, 3, and a WALK mode). By default, the display is at level 1 assist level when it's turned on. A 0 means that no assist gear is used at all. The assist level selection interface is as shown below.



Level 3



Level 2



Level 1



Neutral

## 3.3. Switching display Information

Short press **Function button** to switch between TRIP, TRIP TIME, AVG, MAX, and TOTAL when the display is on.

The mode switching interface is shown below.



### 3.4. Switching display Information

Long press **Down button** for 2 seconds to activate WALK mode (you will see  at the PAS position at this time); release the Down button to exit WALK mode. The WALK mode switching interface is shown on the right.









### 3.5. Front Light Switch

Long press **Up button** for 1 second to turn on the front light (controller support is required); at this time the front light icon will light up on the display interface; long press **Up button** for 1 second again to turn the front light off; at this time the front light icon will disappear.

### 3.6. State of Charge

Battery capacity is indicated by the number of bars (1 to 5), provided that the battery is not under-voltage. When the battery is under-voltage, a battery frame icon will flash to remind the user of charging the e-bike immediately. The battery level is displayed as shown below.

\* The table below shows the correlation between Battery capacity (C) percentage and the icon.

Serial No.	State of Charge (SOC)	Display	
1.	$C \leq 5\%$	The battery frame flashes	
2.	$5\% < C < 15\%$	1 bar	
3.	$15\% \leq C < 35\%$	2 bar	
4.	$35\% \leq C < 55\%$	3 bar	
5.	$55\% \leq C < 75\%$	4 bar	
6.	$C \geq 75\%$	5 bar	



# 4. User settings

Setting options: **Unit, password, auto off time, and restore factory settings**

## 4.1. Enter settings

- 1) 20 seconds after the display is powered on, long press **Function button** for 3 seconds to have the system enter the user settings interface, where you can set and view relevant parameters.
- 2) Long press **Function button** for 3 seconds to exit the user settings interface and save the settings; you can also select [Exit] in the setting interface and short press **Function button** to exit the user settings interface and save the settings.
- 3) The display will return to the normal riding state without saving the parameter settings if no operations are made on the user settings interface in 10 seconds.
- 4) Short press **Up button / Down button** on the user settings interface to select a setting.
- 5) Short press **Function button** to change a setting and **Up button / Down button** to switch to other settings.

## 4.2. Enter settings

Press **Up button / Down button** to select a setting, short press **Function button** with Exit selected to return to the settings interface, and short press **Function button** on KM/Mile to switch between kilometers and miles for units.

**KM :** The unit for TRIP and TOTAL is KM, while the unit for current speed, AVG, and MAX is KM/H.

**Mile :** The unit for TRIP and TOTAL is Mile, while the unit for current speed, AVG, and MAX is MPH.

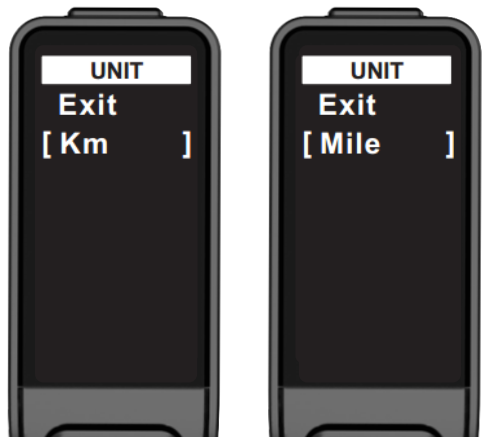

### 4.3. Password settings

To enter password settings, press **Up button / Down button** to select the setting; select OFF/ON, and then short press **Function button** to select between ON or OFF. Select ON and set a password if you need a power-on password; short press **Function button** to change the position from left to right; short press **Up button / Down button** to change each digit; select Exit to save the settings and return to the previous menu.

The interface is shown below.

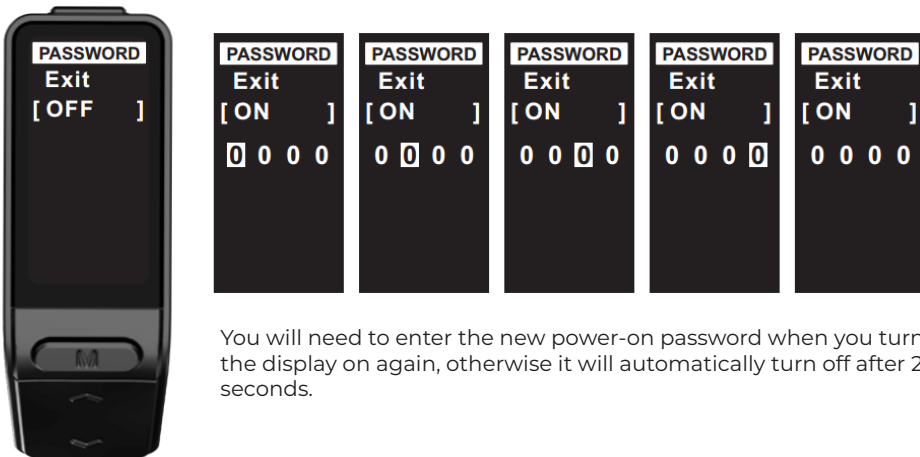

You will need to enter the new power-on password when you turn the display on again, otherwise it will automatically turn off after 25 seconds.

### 4.4. Battery information

Short press **Up button / Down button** in the battery information interface to return to the settings interface.

**SOC** : State of charge

**Voltage** : Battery voltage

**Capacity** : Remaining capacity

**Cycles** : The number of cycles that the battery has undergone

Some functions require BMS support.

The interface is shown on the right.



#### 4.5. Auto off time

Press **Up button** / **Down button** in the auto off interface to select the off time (by default, it's 5 minutes); short press **Function button** to save and return to the settings interface.

**The interface is shown on the right.**



#### 4.6. System Information

Short press **Function button** in the system information interface to return to the settings interface.

**S/N** : Device serial number

**FW Ver** : Firmware version number

**HW Ver** : Hardware version number

**The interface is shown on the right.**



#### 4.9. Restore factory settings

To restore factory settings, press **Up button** / **Down button** to select the setting; select YES, and then short press **Function button** to restart the display and restore settings to factory defaults; select Exit to exit this page and return to the previous menu.

**The interface is shown on the right.**

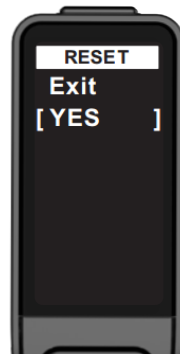

# 5. Data clean

Within 20 seconds after the display is powered on, long press **Function button** for 3 seconds to enter the data clean interface; short press **Function button**, then press **Up button / Down button** to select an option in the confirmation window, short press **Function button** again to clean data for TRIP, TRIP TIME, AVG, and MAX, and then return to the main interface. The display will return to the main interface without cleaning any data if no operations are made within 5 seconds.

The above data will not be cleaned when you power down or shut down the display normally.





# 6. Error information

When the display detects a fault, it will show an error code to alert users of the malfunction. This is how the interface looks in this scenario:



### Error code definitions

The table of error codes is shown below.

S/N	Error Code	Type	Description	Remarks
1.	0x07	Over-voltage protection	The voltage is 1.25 times higher than the rated voltage.	
2.	0x08	Error in the motor's hall signals	The motor's hall signals are absent or abnormal..	
3.	0x12	Current sensor error	The controller detects that the current of the system is abnormal (the current has exceeded the upper limit set by the system).	
4.	0x14	The controller temperature reaches the temperature protection point	The controller detects abnormal operating temperature.	
5.	0x21	Speed sensor error /motor speed data error	The motor speed data is abnormal.	
6.	0x30	Communication error	The communication between the display and the controller is abnormal.	
7.	0x25	Abnormal sensor signals	Sensor signals are out of the normal range.	

**Bike  
usage.**



# 1. How to connect your e-bike to the TENWAYS App

- 1) Turn on the display of your e-bike.
- 2) Keep your smart phone's Bluetooth on, and make sure to grant Bluetooth access to the TENWAYS APP.
- 3) Open the TENWAYS App, and give the App access to Bluetooth.
- 4) Tap "Register" on the Home Page.
- 5) Follow the instructions and scan the QR code at the down tube.
- 6) Key in the name, color, and size of your e-bike, and tap "Ready to connect".
- 7) Wait for your e-bike to appear on your screen, and tap on it to confirm connection.



## 2. Before your first ride

- 1) Charge the battery to 100% before your first ride.
- 2) When charging your e-bike:
  - (1) Charge the battery indoors and keep it away from direct sunlight, rain or snow.
  - (2) Do not charge the bike with non-TENWAYS chargers.
  - (3) Ensure a proper ambient temperature. The best ambient temperature for the charger is 20 °C to 25 °C. A lower temperature may lead to insufficient charging, while a higher temperature may lead to overcharging.
  - (4) To charge, connect the charger to the battery charging port, then connect the other end of the charger to an electrical outlet. To remove the charger, disconnect the charger first from the electrical outlet, then disconnect the other end from the battery charging port.
- 3) Check the tire pressure by hand or with a tool and ensure the pressure is within a range of 50-75 PSI/3.4-5.1 bar.
- 4) Press the driving belt to check whether the belt tension is proper (you should be able to press the middle part of the belt down 10-15 mm if the tension is moderate).
- 5) If using your e-bike on public roads, please ensure that you comply with local riding regulations, for example, those which govern riding equipment, control lights, and reflectors.
- 6) Make sure that you wear the correct protective equipment. Always wear a helmet and make yourself visible to others.
- 7) When properly adjusted, the saddle should be at hip height.
- 8) Check and ensure that the front wheel quick release, handlebar, brakes, pedals, and other related parts of the e-bike are properly fastened before you start to ride.
- 9) The brake settings vary by country/region. Check which brake lever acts on which brake first, and if it does not comply with your habits, we recommend that you ask an expert to change the settings so that you can accurately brake the front and rear wheels if an emergency occurs while you're riding. If you encounter any problems while riding, please brake first (please brake the two wheels at the same time to stop within the shortest possible distance).
- 10) Check the maneuverability of the handlebar; the steering has a crucial impact on braking and riding safety.
- 11) We recommend that you purchase relevant insurance for bikes or e-bike riding in your area so that you can contact your insurance company or agency promptly to get adequate protection in the event of an accident.

# 3. Routine maintenance

## 3.1. Daily inspections

- 1) Before riding, check whether the screws in the following key parts are properly tightened:
  - (1) Screws between the handlebar and the front fork stem
  - (2) Screws between the stem and the handlebar
  - (3) Screws between the brake lever and the handlebar
  - (4) Screws between the brake clamps and frame or front fork
  - (5) Screws between the discs and bottom brackets
- 2) Use the tools provided to tighten any loose screws.
- 3) If you live near the seaside, apply a tiny bit of oil around the bolts regularly to prevent rusting.
- 4) After all screws are properly tightened before the first ride, check if they maintain the same fastening performance when your e-bike reaches a 200 km riding distance and at every 1,000 km after the initial 200 km.
- 5) It is recommended to check the fastening performance of screws at every 600 km if you usually ride under complex road conditions.

## 3.2. Daily cleaning

- 1) Use a rag or large brush to clean off dust when there is not much mud on your e-bike.
- 2) When there is a lot of mud on your e-bike, use a brush dipped into soapy water to wash it off, rinse it with a little clean water, and then dry it with a soft cloth.
- 3) Check the wear degree of the brake blocks after you have them cleaned to see if they can ensure normal braking. Replace them promptly if they are seriously worn.
- 4) It is recommended to clean the e-bike after you ride it for about 200 km. You need to clean the bike first before you put it into storage if you plan to not ride for a long period of time.

**Attention:** Do not clean the bike with a high-pressure water gun, as this might damage the mechanical pivots and related mechanical fitting parts.

### 3.3 How to maintain the battery

Operating and storage temperatures of the battery.

- 1) Working temperature of the lithium battery is 0 °C to 30 °C.
- 2) It is recommended that the lithium battery be stored in an environment where the temperature is 0 °C to 25 °C , and the humidity is 65 ± 20% RH.
- 3) The performance of lithium batteries is affected by the ambient temperature. Don't worry if the performance of your battery degrades during cold weather. The battery performance will resume when the temperature rises.
- 4) Keep the power at 50% to 70%, check the battery condition every 2 months to avoid damage caused by over-discharging, charge and discharge the battery every 3 months if it is not used for a long time.

### 3.4. How to maintain the brakes

- 1) The new brake blocks and discs feature relatively smooth surfaces. Braking power will improve after you ride 100 km or brake on long downhill 3-5 times, when these surfaces will be come roughened.
- 2) Check screws between the brake lever and the handlebar, as well as screws between the brake clamps and frame or front fork:
  - (1) Check if these screws maintain the same fastening performance when your e-bike reaches a 200 km riding distance.
  - (2) Check the fastening performance at every 1,000 km after the initial 200 km.
  - (3) It is recommended to check the fastening performance of screws every 600 km if you often ride under complex road conditions.
- 3) The wear degree of brake blocks should be checked after you've ridden on normal roads for 1,000 km, or 600 km if the road conditions are complex. The blocks should be replaced promptly when two thirds or more are worn.
- 4) Contact a professional store and ask a technician to refill the lubricant after you confirm that there is no sign of oil leakage on the brakes when you feel that they are obviously softened , even if the brake blocks' degree of wear is still acceptable.
- 5) Contact a professional store and ask technicians to diagnose and fix the cause of any abnormal noise during riding which persists after you have cleaned any oil from the brake blocks and discs.

### **3.5 Professional store maintenance**

It is recommended to go to a professional store for maintenance 2-3 times a quarter, or after every 1,000 km of riding. The following items should be checked during such maintenance:

- 1) Performance of the hydraulic brakes.
- 2) The tightness of screws, especially those between the discs and bottom brackets, in key parts.
- 3) The wear degree of the front fork parts.
- 4) The wear degree of the front hub bearings.
- 5) The wear degree of the pedal pivots.
- 6) The professional store's technicians should lubricate the internal pivots to ensure the smoothness of pivots in front fork parts, front hub bearings, bottom bracket, and other parts.
- 7) The wear degree of the tires.
- 8) The fastening performance of the bottom bracket torque sensor, battery, controller, motor, odometer, and other electronic control parts.

# Frame code

The frame code, which is in the form of a QR code, can be found near the bottom bracket at the bottom of the down tube. You can scan the QR code with your phone to see the 15-digit frame code. You can use the frame code to purchase insurance. Please provide your frame code information when contacting us for consultations.







**Important  
reminders.**



# 1. Warranty

- 1) This product (CGO600 Pro) has passed the relevant certification of EN15194-2017 electrically powered assisted cycles regulations.
- 2) All original components are covered by warranty for a period of two years from the date of delivery.
- 3) Claims under this warranty must be made directly to TENWAYS and a proof of purchase is required.
- 4) The warranty applies to original owners and is transferable to further owners.
- 5) The warranty does not cover:
  - (1) An incorrect assembly or installation of the product by the user.
  - (2) An improper or negligent use, operation or transformation of the product.
  - (3) Maintenance activities contrary to the maintenance instructions of the product (e.g., lack of maintenance of the brakes).
  - (4) Normal wear and tear.
  - (5) Defects inherent to the normal useful life or service life of the product.
  - (6) Damages or defects due to accidents.

## 2. FAQ

**Q:** What is the model of this e-bike? Which terrains is this e-bike targeted at?

**A:** The model is TENWAYS CGO600 Pro. It's an urban commuter intended for urban pavement or slightly potholed roads. Do not ride it on mountain roads. Otherwise, accidents may occur.

**Q:** What is the weight of the whole bike including the battery?

**A:** The weight is approximately 16 kg.

**Q:** What should I do if any parts are damaged or any abnormality occurs during use?

**A:** Please contact TENWAYS customer service immediately, or turn to relevant professionals for inspection and maintenance.

**Q:** How long would it take to fully charge the battery?

**A:** Approximately 4.5 hours.

**Q:** What is the riding distance of one battery charge?

**A:** 65 km to 100 km.

**Q:** What are the tire pressure requirements?

**A:** Air pressure of the tires should stay within the range of 50-75 PSI/3.4-5.1 BAR.

**Q:** What is the proper belt tension?

**A:** The tension value should stay within 45 to 60 Hz (35 to 45 lbs), which means the middle part of the belt should sink 10 mm to 15 mm when pressed down by hand.

**Q:** What is the overall noise level of this product while riding?

**A:** This product has passed the relevant certification of EN15194-2017, meaning the rider will not hear any sound higher than 70 dB from this e-bike during riding.

# 3. Warnings

- 1) This bike is designed for urban riding. Do not use it for racing, mountain biking, or other non-urban usage scenarios. It is important to understand your e-bike and its intended use, as personal safety incidents may occur when you use it in the wrong usage scenarios.
- 2) Inspection and maintenance are very important to the safety and service life of your e-bike. You should check the brakes, tires, handlebar, and rims regularly. Any unmaintained parts may break or perform poorly, possibly causing life-threatening accidents.
- 3) If you choose to attach a spring-loaded child seat, please make sure it is installed and fitted correctly to avoid possible injury.
- 4) Your bike must comply with legal regulations for riding on public roads in all conditions, including inclement weather, at night, early morning or dusk. It is your responsibility to familiarize yourself with and comply with all applicable laws in your country, including properly equipping you and your bikes as required by law.
- 5) Improper fitting, installation, operation and maintenance of any accessories and parts may cause serious personal injuries or even death. Do not modify the frame or original components in any way. Modifications may cause damages to your e-bike and lead to life-threatening accidents. Mismatched accessories or incorrect installation can affect product performance and make riding unsafe.
- 6) Like all mechanical parts, bikes are also subject to wear and stress. Different materials and components may react to wear or stress fatigue in different ways. Make sure you have spare parts ready for tires, brake blocks, and other fragile parts. If the design life of a component has been exceeded, it may suddenly fail, causing injuries to the rider. Any cracks, scratches, or color changes indicate that the life of the component has been reached and it should be replaced.
- 7) Extra caution should be exercised when you install any third-party accessories on your bike, this may increase the load and raise the overall center of gravity for the bike. If the bike gets out of control, you may be injured or even killed.
- 8) Do not touch the brake discs while the front and rear wheels are still turning, or after you use the brakes. You may be injured or burned.
- 9) If you have any questions related to the battery, please feel free to contact TENWAYS.
- 10) A great deal of concentration is required when you're riding. Uncontrolled or sudden braking or steering may result in an accident.
- 11) Do not modify or tamper with the motor and built-in computer system of the bike. Modification or tampering of any kind will void your warranty and may cause a life-threatening accident.

- 12) The brake settings vary by country/region. Check which brake lever acts on which brake first. If it does not comply with your habits, we recommend that you ask an expert to change the settings.
- 13) Urban cycling can be dangerous. Riding without a helmet can result in serious injuries or even death.
- 14) Do not use a headset or talk on the phone while riding.
- 15) Do not ride when you don't have full control of the bike.
- 16) The CGO600 Pro is not designed to match any trailers.
- 17) Ride with extra caution on slippery surfaces. Ride slowly and brake lightly to allow for longer braking distances.
- 18) Your riding speed should fit the road conditions, your capabilities, and local laws and regulations.
- 19) The disc brakes used in this model may perform differently from other brake systems. Please familiarize yourself with their special feeling before riding for the first time.
- 20) Ensure that all lights function properly and are not blocked. We recommend the use of lights in all environments to ensure maximum visibility.
- 21) Do not install a child seat on the CGO600 Pro. This may result in injury or death.
- 22) Do not keep the motor running under high load for a long time.
- 23) Do not charge the bike with any non-TENWAYS chargers.
- 24) Do not place the bike in a strong magnetic field, or put any magnetic objects near the bottom bracket.
- 25) The bike is designed to withstand a maximum weight of 120 kg, exceeding this weight may cause a life-threatening accident.
- 26) Do not hang bags, umbrellas, and other overly large or heavy items on the handlebar.
- 27) Do not wear overly long clothes while riding, as they may get entangled in the wheels or crankset.
- 28) Do not attempt to open or touch the internal components of the e-bike, as this may cause permanent damage.
- 29) Do not break the motor violently, or immerse the motor in water.
- 30) Unless required for maintenance, do not attempt to remove the display.
- 31) Do not use components from other e-bike brands on TENWAYS e-bikes.
- 32) This manual cannot cover the installation and maintenance methods for each e-bike part, and the technical details shown in texts and illustrations in the manual may also change, so please contact TENWAYS if you cannot find answers to your technical problems.



## ATTENTION

- The battery pack **MUST** be locked onto the frame battery mount before use.
- Ensure the battery and charger are not damaged before charging.
- Don't connect the positive and negative terminal of the battery pack.
- Don't expose the battery to high temperatures.
- Ensure the battery charger is unplugged from the battery pack and put away before you ride.
- Always charge your battery in temperatures between 10 and 26 degrees Celsius.
- Do not subject the battery to salt water or leave the bike for extended periods in the rain.
- Only use original equipment for charging.

RoHS

