

SUNHOUSE
12 FT X 12 FT
MODEL SH1212

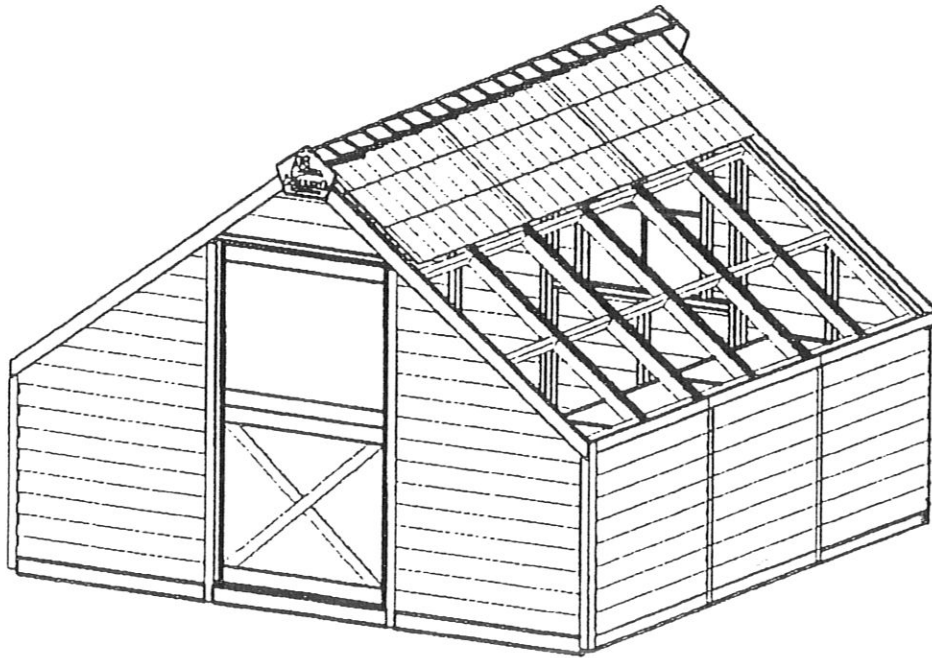

ACCESSORIES AND HARDWARE

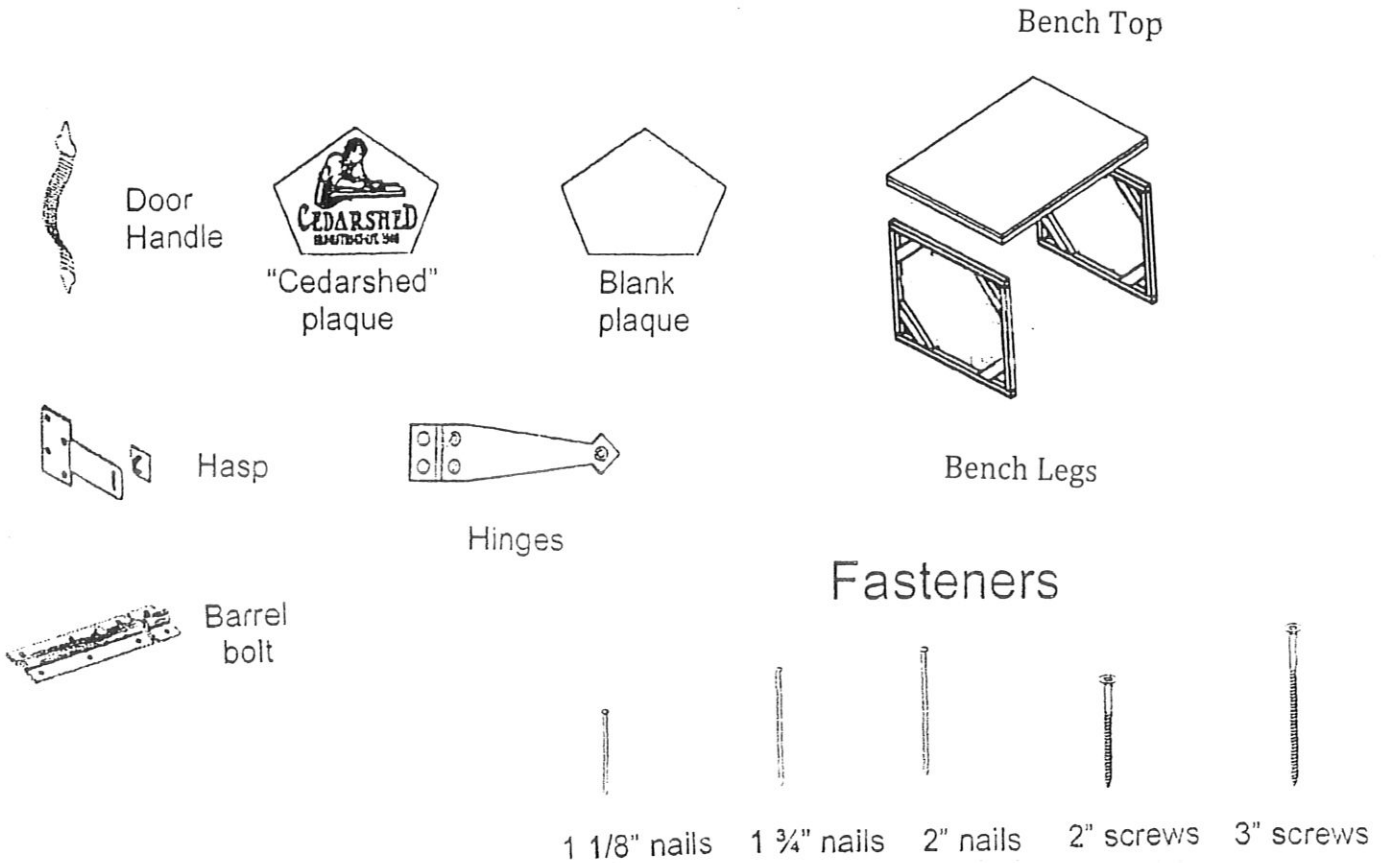

PART #	DESCRIPTION	DIMENSIONS (where app.)	# OF PCS
ACCESSORIES			
P-H-PLAQL	peak CS plaque		1
P-H-PLAQLN	peak plaque		1
C-BL-001	bench legs	34 1/2 x 30	12
C-BT-002	bench tops	34 1/2 x 46 1/2	6

PART #	DESCRIPTION	DIMENSIONS (where app.)	# OF PCS
FASTENER			
P-H-NL1.125	nails	1 1/8"	25
P-H-NL1.75	nails	1 3/4"	300
P-H-NL2	nails	2"	50
P-H-NWASHERS	neoprene washers		100
P-H-SC2	screws	2"	400
P-H-SC3	screws	3"	500

PART #	DESCRIPTION	DIMENSIONS (where app.)	# OF PCS
DOOR AND HARDWARE			
C-DR-003	door	Dutch door	1
P-H-THING6	t-hinges	6"	4
P-H-BBLT4	barrel bolt	4 inch	1
P-H-DHAND	handle	handle	1
P-H-FTAPE25	foam tape	4-25 ft rolls	100ft
P-H-HASP	hasp	hasp	1

Instruction manual, questionnaire and driver bit

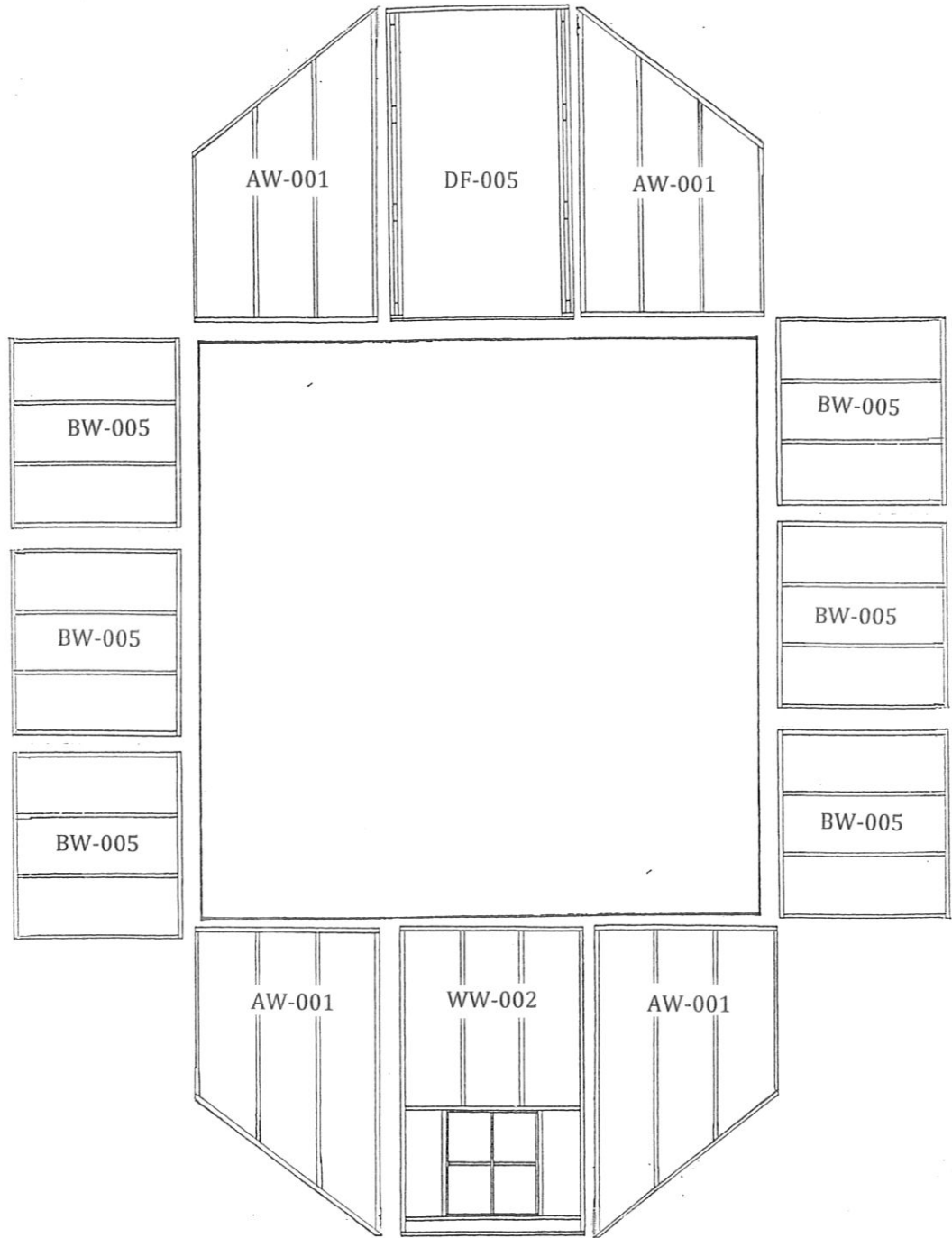

PART #	DESCRIPTION	DIMENSIONS (where app.)	# OF PCS	CODE
WALL PARTS				
P-2346G	headers	2 x 3 x 46 1/2	6	not shown
C-BW-005	solid wall	46 1/2 x 38 3/4	6	BW-005
C-DF-005	door frame	46 1/2 x 74 3/4	1	DF-005
C-AW-001	angle wall	46 1/2 x 75 1/4	4	AW-001
C-WW-002	window wall	46 1/2 x 74 3/4	1	WW-002

WINDOW

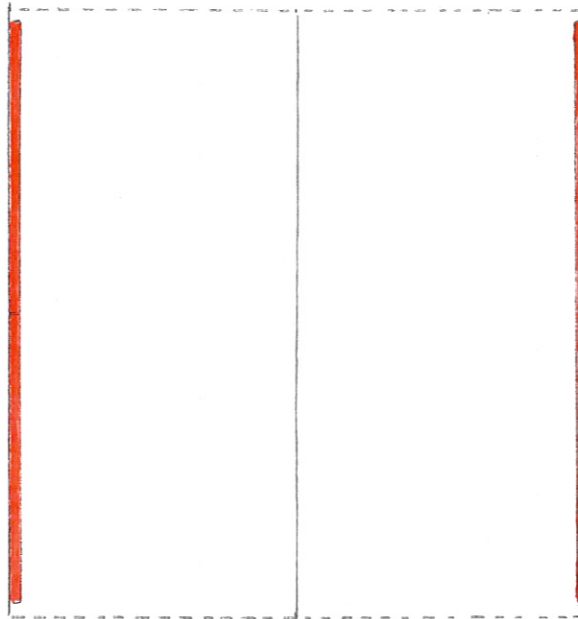





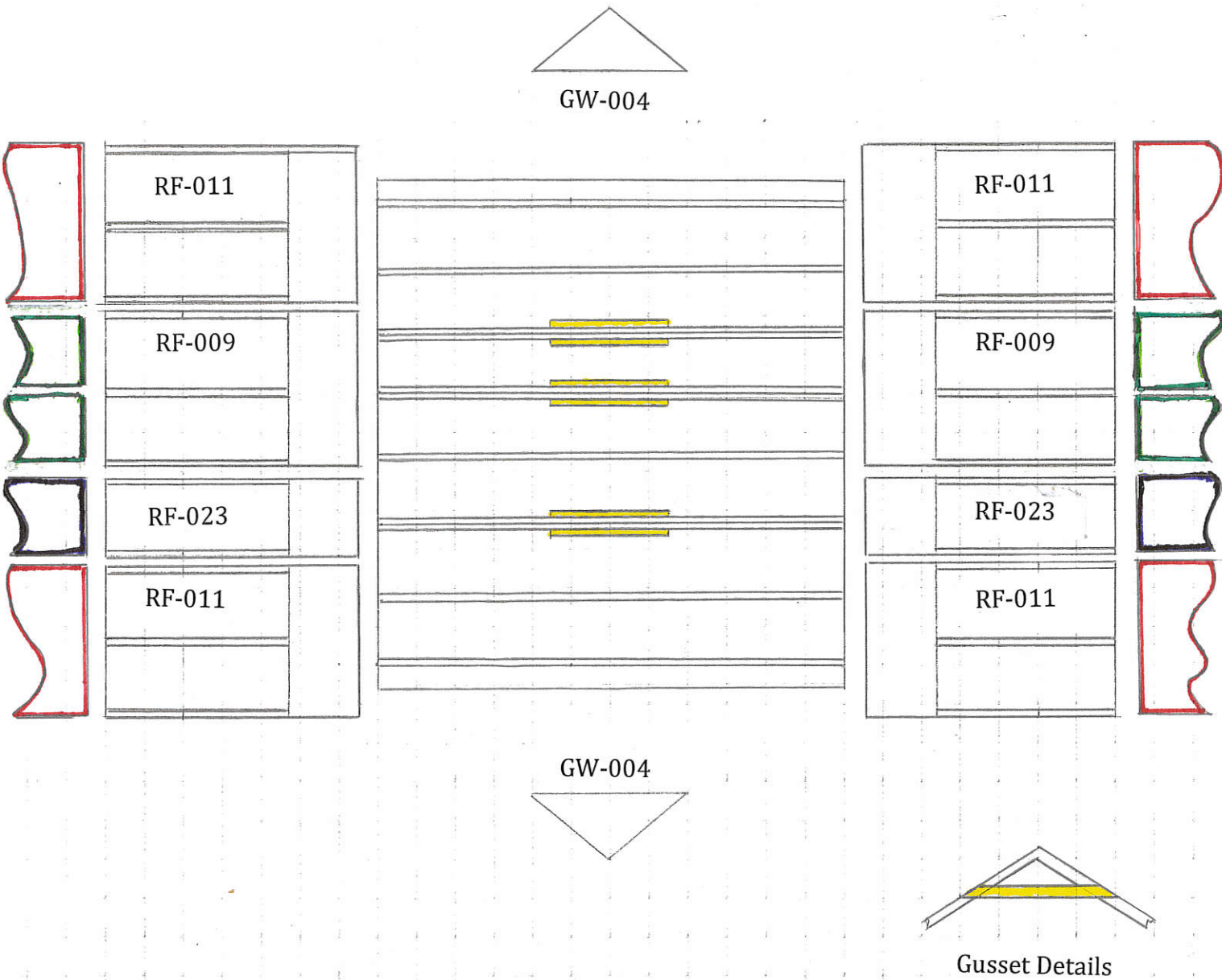

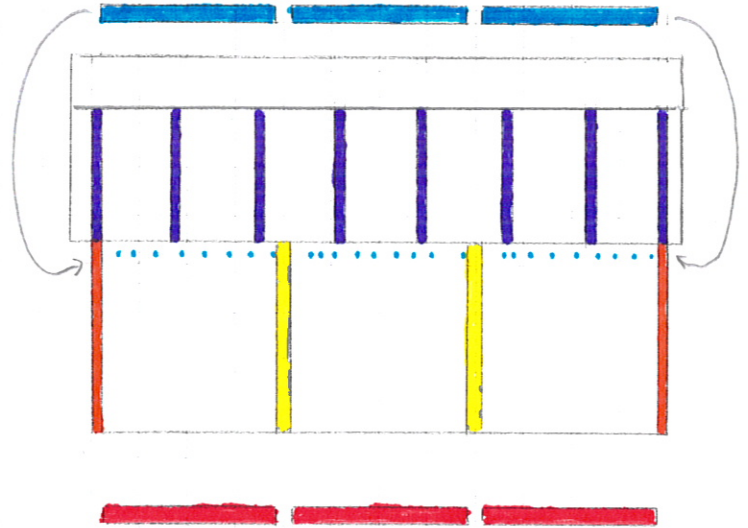
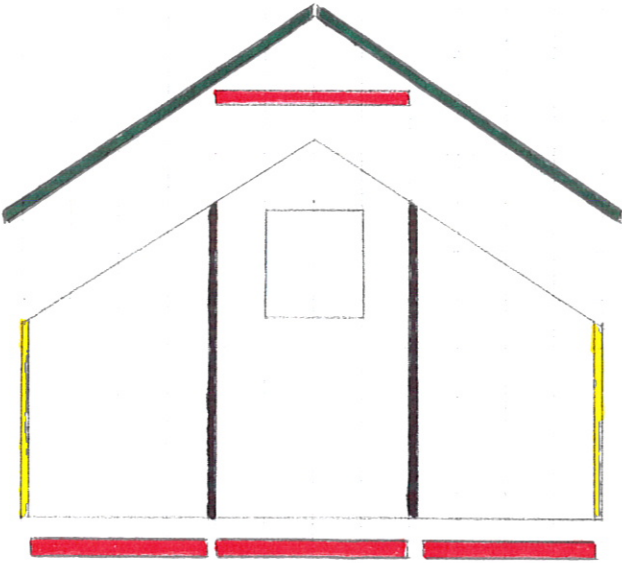
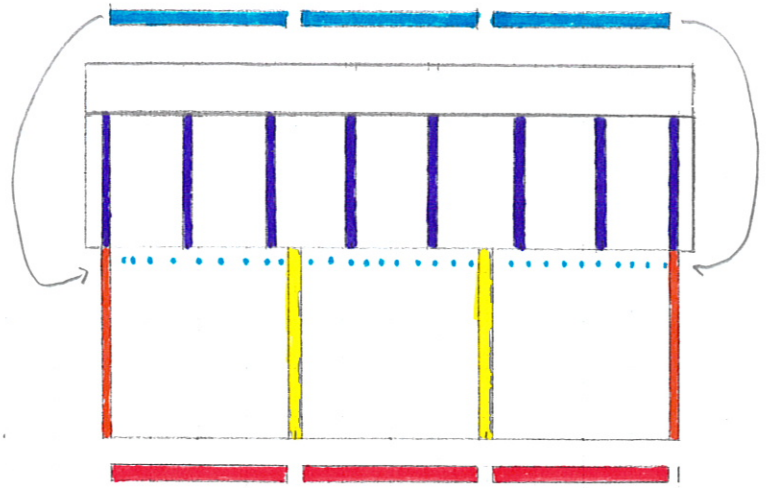
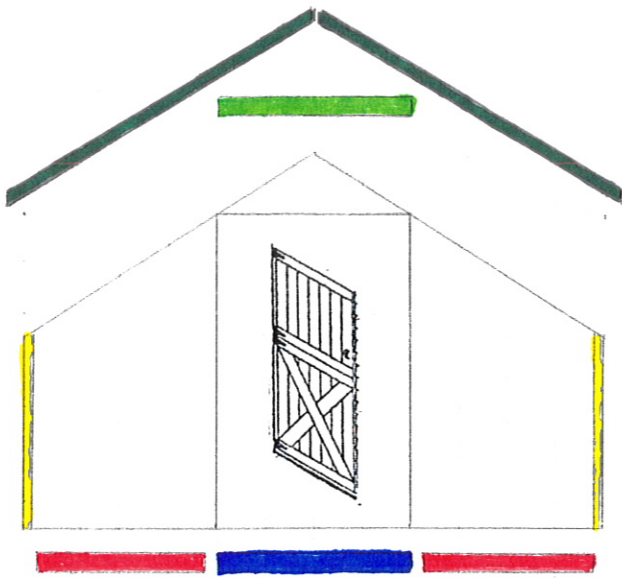

DOOR

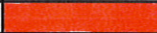
PART #	DESCRIPTION	DIMENSIONS (where app.)	# OF PCS	CODE
TOP PLATES				
P-1369K	top plate	1 x 3 x 69 3/4	4	

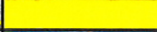

PART #	DESCRIPTION	DIMENSIONS (where app.)	# OF PCS	CODE
ROOF PARTS				
P-2334GYh	gussets	2 x 3 x 34 1/2	6	
C-GW-004	gable wall	46 1/2 x 20 1/4	2	GW-004
C-RF-011	roof panel	42 3/4 x 87 9/16	4	RF-011
C-RF-009	roof panel	46 1/2 x 87 9/16	2	RF-009
C-RF-023	roof panel	24 x 87 9/16	2	RF-023
P-H-LEXA23C59	corrugated plastic panel	23 1/4 x 59	4	
P-H-LEXA2459	corrugated plastic panel	24 x 59	2	
P-H-LEXA42K59	corrugated plastic panel	42 3/4 x 59	4	
P-H-RCAP24	ridge caps	24"	18	not shown
P-H-RFLT12	roofing felt	1 ft by 5 ft	5 sq ft	not shown
P-H-MFLASS	metal flashing	3" x 12"	18	not shown



PART #	DESCRIPTION	DIMENSIONS (where app.)	# OF PCS	CODE
TRIM				
P-13C46G	corner board	1 x 3 1/4 x 46 1/2	4	
P-1279C	vertical trim	1 x 2 x 79 1/4	2	
P1246G	trim	1 x 2 x 46 1/2	8	
P-B-G445	skirting	1/2 x 4 x 45	6	
P-B-G645	skirting	1/2 x 6 x 45	12	
P-14B48	door skirting	1 X 4 1/8 X 48	1	
P-1292CYi	fascia	1 x 4 x 92 1/4	4	
P-1248	door trim	1 x 2F x 48	1	
P-1257	wood roof strip	1 x 2 x 57	16	

SKYLIGHT PANEL INSTALLATION

First take the corrugated plastic panels and make sure to identify the UV protected side (this will be the printed film side). This will be the side that will be exposed to the elements and the sun. Take the two layers of film off (there is a clear film on the underside of the panel as well) and lay them over top of the open roof rafters and battens. Make sure to slide the plastic sheet underneath the wood shingles located at the top of the roof panel. The bottom edge of the plastic sheets will overhang the end of the rafters by 2 inches (5 cm). See Fig SL-001 for details

Once the roof panels are in place then take the foam tape and cut them into 56 1/2 inch (144 cm) length. Remove the plastic film to reveal the sticky side. Affix each piece of foam tape on top of the rafter locations.

Take the wood strips and pre-drill the holes using a 1/16" drill bit. Please refer to Fig SL-002 for details.

Using the 6 neoprene washer and 2" screws attach each of the wood strips on top of the foam tape.

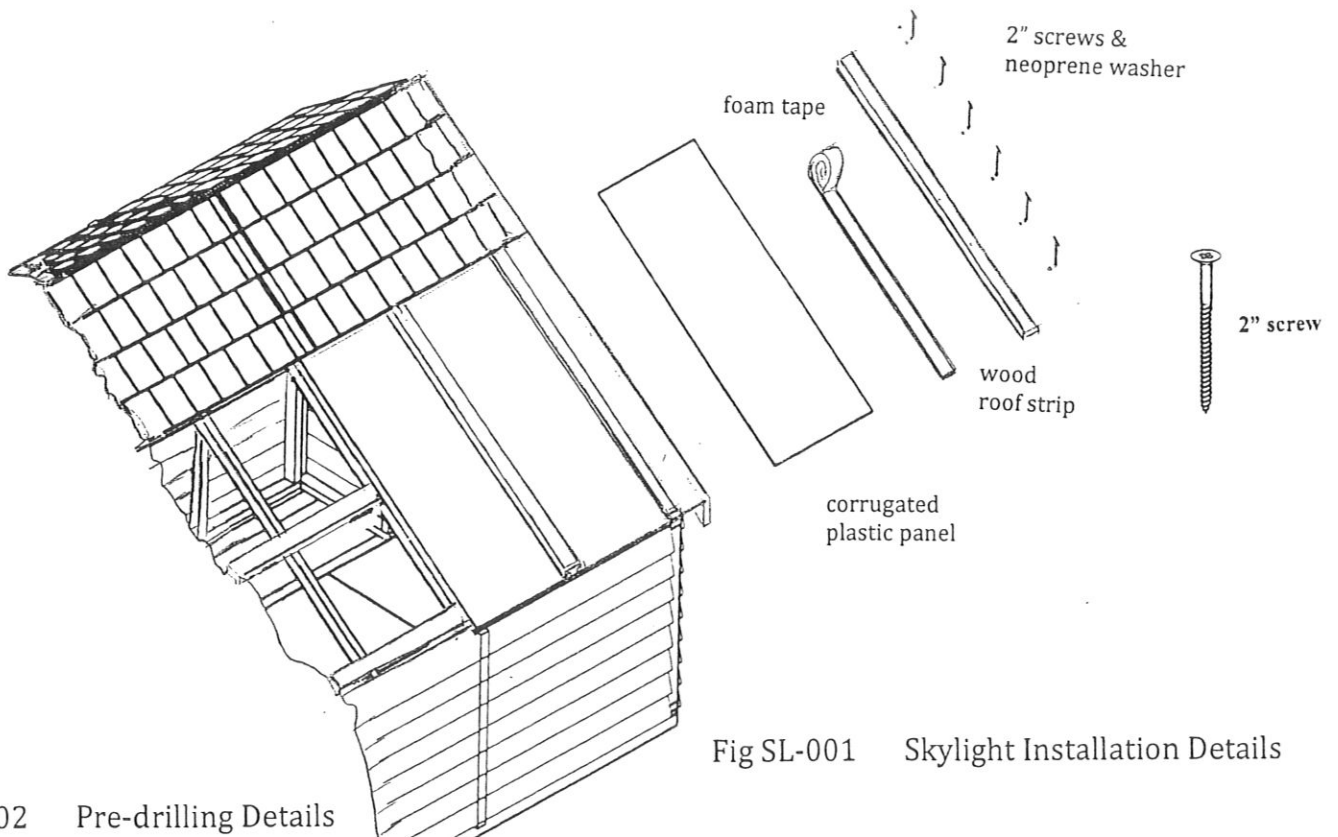

Fig SL-002 Pre-drilling Details

