



Instruction Manual



HDMI (ARC)

USB Input

Digital Optical

AUX Input

Easy Remote Control

Wall Mounting

Enjoy it.

2.1 WIRED SOUNDBAR

Bluetooth | USB | AUX-IN | HDMI (ARC) | Digital Optical

Contents

1 Safety information

Safety information 1

2 Getting to know your Blaupunkt Soundbar

Accessories 2

Control panel and remote control 3, 4

Making the connections 5

3 Using your Blaupunkt Soundbar

Using the optical input 6

Using the HDMI (ARC) input 6

Pairing a bluetooth device 6

Using the line in 7

Using the USB playback for MP3 7

Adjusting the tone quality 7

4 Other information

Wall mounting the soundbar 8

Installing the remote battery 8

Technical specification 9

Care & maintenance 9

5 Product support

Troubleshooting 10



Safety information

Important - Please read these instructions fully before installing or operating

Power source



- This symbol means that this unit is double insulated. An earth connection is not required.
- The appliance must be connected to a 110-240 volt 50/60Hz AC supply by means of a three pin socket.
- Unplug this apparatus during lightning storms or when unused for long periods of time - to prevent damage to this product.



- Opening or removing covers may expose you to dangerous voltages or other hazards.



- To prevent risk of fire or electric shock, avoid overloading wall outlets, extension cords, or integral convenience receptacles.

- Use suitable power sources - Plug the product into a suitable power source, as described in the operating instructions or as marked on the product.

- The supply voltage should be the same as that indicated in the technical specifications and the appliance rating plate.

- If the socket outlets in your home are not suitable for the plug supplied with this unit check with a qualified electrician for replacement.

- In order to disconnect the apparatus from the mains completely, switch off the outlet and remove the mains plug completely.



- Do not bend, stretch or pull the supply cable in order to avoid electric shock.
- When installed, the power socket must be within easy reach.
- Do not install the unit in a confined space. Allow adequate ventilation to prevent heat build-up.
- For indoor use only.

Heat build up

- During use the unit will heat up, this is not a malfunction. If the unit is used continuously at high volume levels, the unit temperature will rise considerably. Do not touch the unit to avoid potential burns.

Colour irregularity on TV screen

Colour irregularities may be seen on certain types of TV.

- If such an irregularity is seen turn off the TV, then turn on again after 15 to 30 minutes.
- If the colour irregularity is still seen place the soundbar unit further away from the TV.

Moisture and water

- Do not use this apparatus near water or moisture.
- Do not use this product near a bathtub, washbowl, kitchen sink, and laundry tub, in a wet basement, near a swimming pool, or anywhere else that water or moisture is present.

Heat sources and flames



- Batteries shall not be exposed to excessive heat such as sun, fire or the like
- To prevent risk of fire or electric shock, avoid overloading wall outlets, extension cords, or integral convenience receptacles.

Servicing and repairs

- Refer all servicing to qualified service personnel
- Servicing is required when the apparatus has been damaged in any way: such as liquid has been spilled or objects have fallen into the apparatus; the apparatus has been exposed to rain or moisture, does not operate normally, or has been dropped.

Getting to know your Blaupunkt Soundbar

You'll be up and running in no time

Accessories

1. A soundbar
2. A external subwoofer
3. Remote control
4. RCA audio cable x 2
5. Instruction manual
6. Wall mounting kits

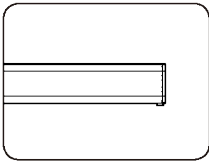

Soundbar

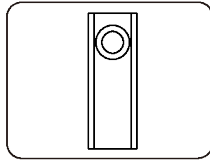

Subwoofer

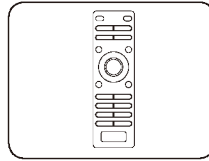

Remote control

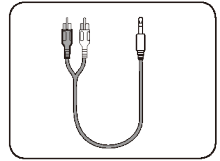

RCA audio cable

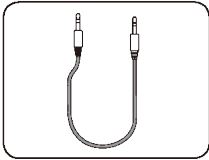

RCA audio cable

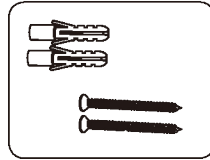

Wall Fixing x 4 Screw x 4

Getting to know your Blaupunkt Soundbar

You'll be up and running in no time

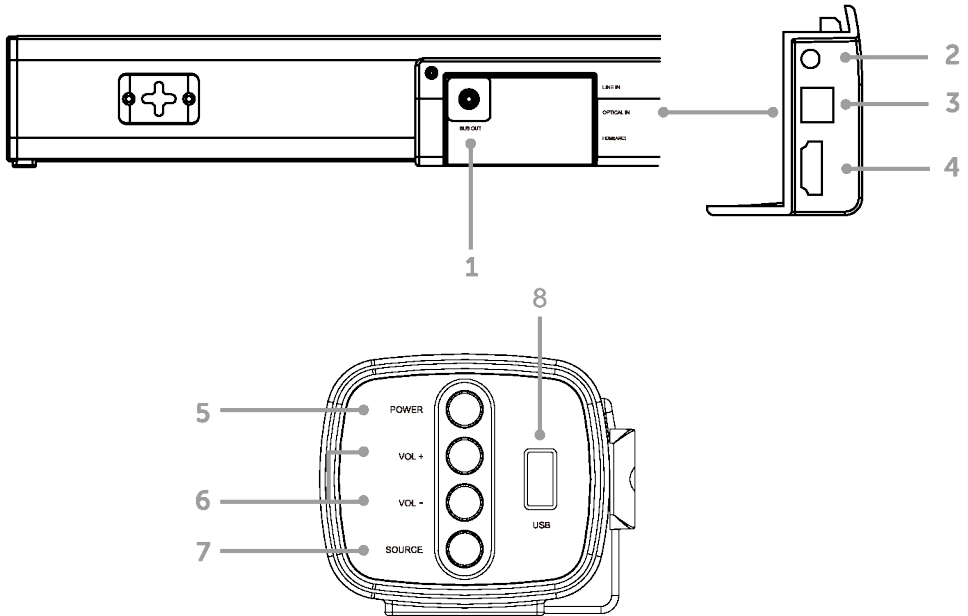

- 1. Subwoofer Output**
- 2. 3.5mm LINE input**
- 3. OPTICAL input**
- 4. HDMI (ARC) input**
- 5. Power** : Press to switch the unit on or off.
- 6. Volume + and -** : Press to adjust the volume up or down.
- 7. Source**
Press to select a input: USB, Line in, Bluetooth, HDMI (ARC) in, OPTICAL in
- 8. USB Input (Mp3 playback)**

Getting to know your Blaupunkt Soundbar

You'll be up and running in no time

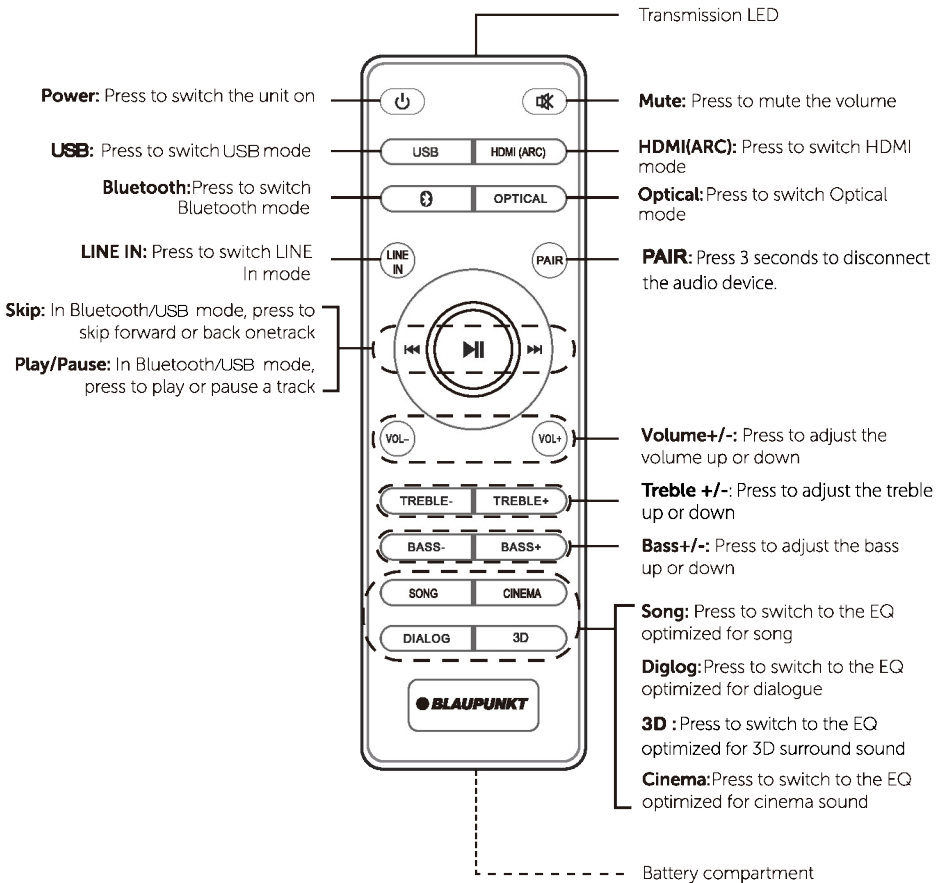

Getting to know your Blaupunkt Soundbar

You'll be up and running in no time

Making the connections

Follow the below connection guide to connect the soundbar to a TV with or without HDMI-ARC output, Bluray / DVD player or an audio source such as MP3 player.

Only one digital connection to TV is required. HDMI-ARC is recommended.

DO NOT power on the mains until all connections are made.

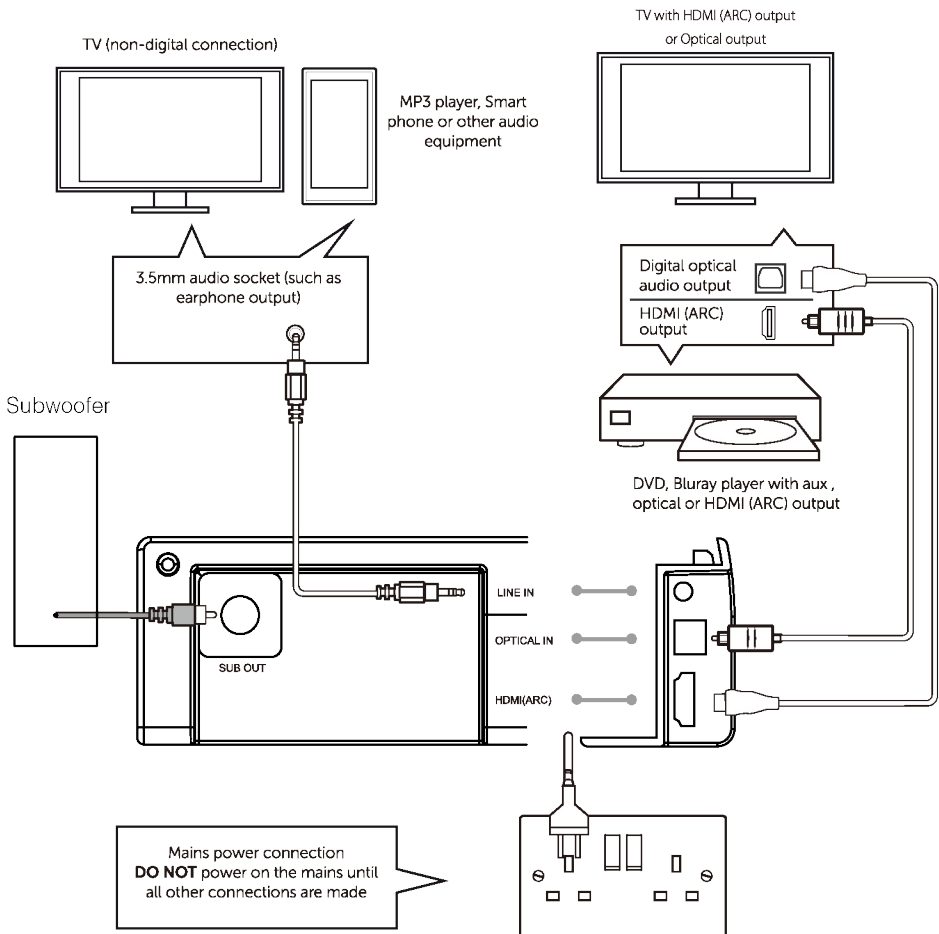

Using your Blaupunkt Soundbar

Let's get started

Using the Optical Input

1. Connect the Digital Optical Audio cable to the optical output on the audio source and to the OPTICAL IN on the soundbar.
2. Press the OPTICAL button on your remote control directly to switch to Optical Mode or one touch Source button on main unit repeatedly to select the Optical mode.
3. Using the native controls on your connected device, make sure the audio settings are set to Optical Audio and are turned On.
4. Audio from the connected audio source will now be played through the speakers.

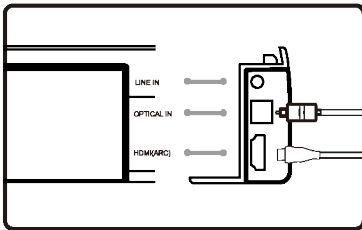

Using the HDMI (ARC) input

1. Connect the socket HDMI (ARC) by means of an ARC-enabled HDMI cable to an HDMI ARC socket of your television set.
2. Switch on the soundbar with the button \mathcal{U} .
3. By pressing the HDMI (ARC) button on your remote control or one touch the Source button on the unit repeatedly to enter HDMI(ARC) mode, select the HDMI input.
4. Switch on the television set. When the connection is established for the first time, it may take several seconds until sound is output from the soundbar.

NOTE:

1. if you use the HDMI (ARC) connection, the soundbar is usually switched on and off via the remote control of the connected device. The connected device must support the CEC (Consumer Electronic Control) protocol.
2. The audio transmission via the HDMI (ARC) socket can only work if all components are ARC-enabled. If the transmission is unsuccessful, you must take one or possibly several of the following items into account:
 - The old HDMI cable must be replaced with a new ARC-enabled cable.

- Not every HDMI socket on the television set needs to support ARC. In this case, the HDMI cable on the television set must be connected to another ARC-enabled HDMI socket. Usually, the respective HDMI sockets are labelled with ARC. If not, refer to the user instructions of your television set.
- For several television sets, the digital audio output must be activated. Select the audio output PCM 2.0 (PCM stereo). If the audio output PCM 2.0 (PCM stereo) is not set on the television set, the soundbar will automatically switch off.

Pairing a bluetooth device

- The operation range of bluetooth is approximately 10 meters (30 Feet). Any obstacles in the path between devices may reduce this range.
 - Only one Bluetooth device can be paired at a time.
 - Not all Bluetooth devices are compatible
1. Press the \mathcal{B} button on the remote control or to one press the Source button on the main unit repeatedly to select the bluetooth mode to switch over to a Bluetooth® connection. LED display shows "bt" flashing rapidly
 2. Switch on the bluetooth audio device (e.g. smartphone) and start the bluetooth® connection.
 3. The bluetooth device will now receive the device identification as "BLAUPUNKT-SBW Dolby"
 4. Both devices are now interconnected. LED display "bt" stop flashing and pairing sound is heard.
 5. There is No password required

In Bluetooth mode, the below buttons functions are available:

PAIR When a device is connect to the sound bar system via Bluetooth, press and hold the **PAIR** button on the remote control for more than 2 seconds to disconnect the audio device from the sound bar.

▶|| When a device is connect to the sound bar system via Bluetooth®, press once to play or pause the current selected song.

▶▶ When a device is connect to the sound bar system via Bluetooth, press once to skip to the next song.

◀◀ When a device is connect to the sound bar system via Bluetooth, press once to replay the current song. Press twice to play the previous song.

Using your Blaupunkt Soundbar

Let's get started

Using the LINE in

1. Plug one end of a 3.5mm audio input cable (included) into the LINE IN on the speaker bar. Plug the other end of the cable into the audio output/headphone output on an MP3 player or other audio source.
2. Press the LINE IN button on your remote control directly to enter LINE in mode or one touch the SOURCE button on the unit repeatedly to enter Line in mode.
3. Audio played through the connected device will now be heard through the speakers.

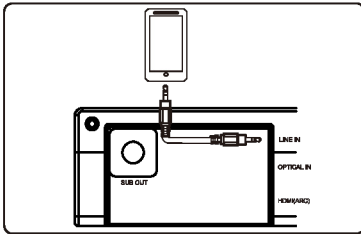

Using the USB playback for MP3

You can also enjoy music from a USB flash drive,

1. Press the Power button to turn on the soundbar.
2. Press the USB button on the remote control to USB Mode or one press the Source button repeatedly to switch to USB Mode.
3. Plug in a USB flash drive with preloaded Mp3 files.
4. The soundbar will automatically play Mp3 files from the USB flash drive. Use the included remote to control music playback.

Adjusting the tone quality

NOTES:

- Changes to the tone quality are not stored when you change into a different mode.
- Press one of the **SONG**, **CINEMA**, **DIALOG**, **3D** buttons to select the presets for the tone quality for music (**SONG**), films (**CINEMA**), dialogue (**DIALOG**) or surround sound (**3D**).
- Use the **TREBLE -/+** buttons to adjust the treble sounds.
- Use the **BASS -/+** buttons to adjust the bass sounds.

Tone quality	Remote control buttons	Display
Music	SONG	SONG
Film Movie	CINEMA	CINEMA
Language	DIALOG	DIALOG
Surround sound	3D	3D

Input	Use	Remote control button	Display
OPTICAL IN	Connection with OPTICAL cable, e.g. to digital receiver, DVD player	OPTICAL	OPTICAL
HDMI (ARC)	Connection with HDMI (ARC) cable, e.g. to the HDMI ARC connection of the television set, DVD player	HDMI (ARC)	HDMI
Bluetooth®	Radio connection, e.g. smartphone		BT
USB	Connection with usb cable eg. MP3 player, telephone	USB	USB
LINE IN	Connection with 3.5 mm stereo jack cable, e.g. MP3 player, telephone	LINE IN	LINE

When in Dolby Audio decoding mode, the indicator light display white colour.

Other information

Helpful technical information

Wall mounting the soundbar

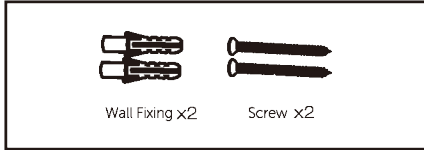

Accessories included

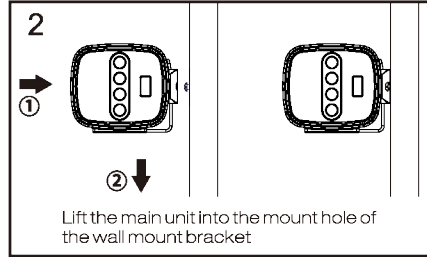
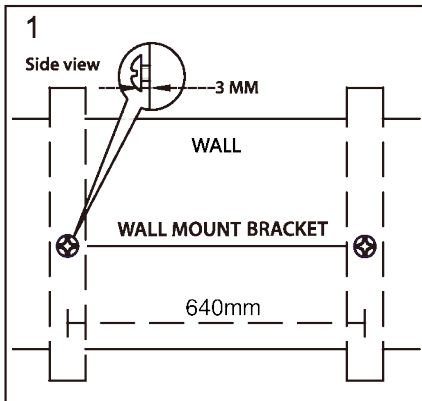

- In order to avoid damage to the unit and personal injury you should get a qualified person to drill the fixing surface and fit the appropriate wall fixings.
- Take care not to allow the main unit to fall while attempting to hook onto the wall mount brackets.
- Before mounting, check the wall strength, if it is not clear then consult relevant qualified personnel.
- When drilling into walls, always check that there are no hidden wires or pipes etc.
- Make sure the screws & wall plugs are suitable for supporting the unit.
- Lift the soundbar preinstalled screw into the mount hole of the wall mount bracket.

Installing the remote battery

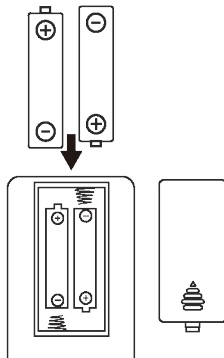

1. Press and slide the rear cover to open the battery compartment.
2. Insert 2 pieces of AAA size batteries (Not Included). Make sure the (+) and (-) ends of the batteries match the (+) and (-) ends as indicated.
3. Close the battery compartment accordingly.

Other information

Helpful technical information

Technical specification

Amplifier	
Input sensitivity	USB,Bluetooth,HDMI 1000mV,LINE IN :1V,OPTICAL IN
Main unit	
Power supply	INPUT: 110-240V ~ 50/60Hz
Standby power consumption	≤ 1.2W
Full range speaker drivers	Impedance: 4Ohm, 2.25"
Subwoofer	Frequency response: 120Hz ~ 20KHz Impedance: 4 Ohm, 165mm (6.5") Frequency response:32Hz ~132Hz
Dimensions	Soundbar: 810 x 73 x 89mm Sub woofer: 170 x 435 x 265mm
Remote control	
Battery	2 x "AAA" size battery (Not Included)
Bluetooth	
Range	up to 10m
Bluetooth version	V5.0
Frequency range	2402MHz ~ 2480MHz

Care & maintenance

After using the soundbar

Set to Standby.

Switch the unit off at the mains and unplug it if you are leaving it unattended for a long period (holidays etc).

Avoid leaving the battery fitted in the remote control if you leave the unit unattended for long periods. It may leak and damage the remote control.

Care & cleaning

All care and cleaning operations should be carried out with the unit unplugged from the mains power.

Occasionally wipe the cabinet with a lint free duster. Never clean the unit with liquids or solvents.

Manufactured under license from Dolby Laboratories. Dolby, Dolby Audio, and the double-D symbol are trademarks of Dolby Laboratories.

Product support

Help is always at hand

Troubleshooting

No power.

- Ensure the mains plug is connected to a power supply, and is switched ON.
- Make sure there is power to the mains socket.

No sound?

- Make sure if playing from the AUX input, the external source has the volume turned up and is outputting sound.
- Make sure the volume is turned up.
- If using HDMI-ARC, ensure the source Digital Output is set to PCM, LPCM, PCM 2CH stereo or PCM downmix
- Bluetooth device not paired. Check 'Pairing a bluetooth device'.

No response from the soundbar.

- Unplug the power cable for 1 minute then plug back in again.

Remote control does not work.

- Reduce the distance between the remote and main unit
- Check the batteries are installed correctly.
- Replace the batteries
- Aim the remote directly at the soundbar

WARRANTY INFORMATION 1 YEAR*

If you have issue with our 2.1 Wired Soundbar product please contact our service center. Authorized Service Center Blaupunkt Speakers

Address: Envent World Wide Private Limited
KH NO-96/2, Village-Bamnoli, Sector-28, Dwarka, Bamnoli West Delhi - 110077
E-Mail: wecare@blaupunkt-audio.in | **Tel:** 1800 843 4333

Please prepare and submit the following information during the telephone or e-mail notification to facilitate the process:

- Serial number
- Date of purchase
- A copy of proof of purchase in case of warranty

Note - Important information:

Please use the original packaging or other suitable packaging to protect the unit in transit.

