



Instruction Manual



TRUE WIRELESS
BTW-01



Contents

• Brief Introduction	1
• Before use	1
1. Overview	2
2. Charging for earbuds	3
3. Charging for charging case	4
• Getting started	6
1. Wearing earbuds	6
2. Two earbuds connecting with cellphone	7
3. One earbud connecting with cellphone	8
4. Earbuds Matching/TWS Mode	11
5. Function operation	12
6. Function operation-use two earbuds	16
7. Battery display	16
8. Prompt tone	17
9. Factory Reset	18
• Care and maintenance	19
• FAQs	20
• Specification	21
• Warranty Information	22

Thank you for buying BTW-01 Bluetooth Earbuds.
Please read this user's manual carefully before use.

- **Brief introduction**

BTW-01 is a True Wireless Bluetooth Earbuds, each ear piece comes with a Microphone that can be used individually or used together for stereo sound. The earbuds supports music and calling function, as well as touch sensitive playback and pause control.

- Before use

1. Overview

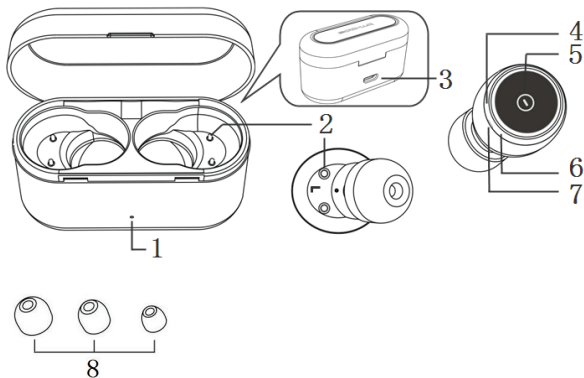

1	Charging indicator light	5	MFB touch-button
2	Charging metal contact	6	LED indicator (blue)
3	Charging jack	7	Microphone
4	LED indicator (red)	8	Big/medium/small Ear tips

2. Charging for earbuds

When the earbuds are low on power, the earbuds emits "Battery low" once every 2 minutes and the red Led flashes slowly four times every 1 minute. Please recharge the battery of earbuds.

Following is the way of charging for the earbuds:

Using USB cable

1. Put the earbuds into the charging case to ensure that the charging device connects well and start charging when you see the red indicator light of the earbuds on.

Red light on: Charging

Red light off: Finish charging

2. Charging should be completed in roughly 1.5 hours.

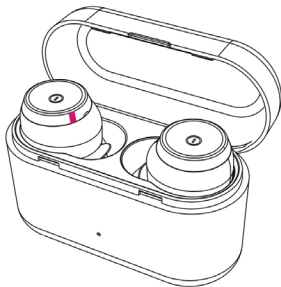

Remarks:

- The left and right earbuds on charging case of an arbitrary charge can be charged.
- Please close the charging case cover, so that the earbuds and the charging case connects well when it is charging.

3. Charging for charging case

When any of the following situations occurs during the use, it indicates that the charging case has gone into sleep mode with low power. You need to charge the charging case:

- 1) After putting the earbuds into the charging case, the earbuds will not automatically shut down or turn on the red light.
- 2) During charging, the earbuds suddenly turns on automatically.
- 3) Removing the earbuds from the charging case will not automatically turn on.

The way of charging for the charging case is as following:

Using USB cable

- 1) Plug the micro USB charging cable into the case's charging jack.
- 2) Plug the USB cable into a USB port of PC or a 5Volt USB charger.
Red light on: Charging
Red light off: Finish charging
- 3) Charging should be completed in roughly 1.5 hours.
- 4) If the earbuds are in the charging case, it can charge the earbuds while charging the charging case.

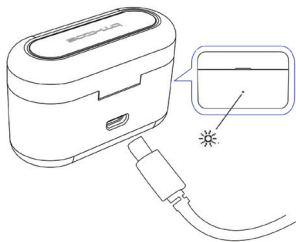

Remarks:

- 1) The battery is recyclable.
- 2) Batteries (battery pack or batteries installed) shall not be exposed to excessive heat, such as sunshine, fire etc.
- 3) Please make sure the charging jack is dry before charge.

- **Getting started**

1. **Wearing earbuds**

- a. Choose the suitable size ear tips

- b. Ensure each earbud is worn on the correct ear. "L" should be worn on the left ear and "R" should be worn on the right ear.

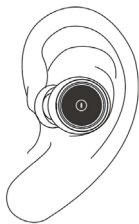

Left ear



Right ear

2. Two earbuds connecting with cellphone

In this mode use two earbuds at the same time to enjoy stereo sound.



Take out both earbuds from Charging Case. Both earbuds will try to match with each other indicated by Blue light flash. Once they are successfully matched, Blue light in Right earbud will flash twice after every 10 seconds, for Left earbud – Red and Blue light will flash alternatively for first time use and Blue light will flash twice every 2 seconds for every concurrent use indicating Left earbud is in pairing mode and ready to be paired / connected with your mobile device. You can now connect your mobile device with the earbuds and both sides will work together.

Remarks:

- Pairing mode lasts for 2 minutes, the earbuds will switch to power off mode if no device connected within that time.
- The earbuds will be connected with the latest device and will be paired automatically when powered on.
- If the earbuds are disconnected from the device beyond the distance, it will automatically power off after 5 minutes, and it will automatically connect when it returns to the effective distance within the first 3 minutes.

3. One earbuds connecting with cellphone

Each earbud can be worn individually as Bluetooth earbuds.

3.1 Power on

- 1) When charging, the earbuds will turn on automatically when they are taken out of the charging case.
- 2) If not turned on, press and hold touch-button for about 3s until blue LED flashes and at the same time earbuds emits "Power on". Then release the touch-button. It is now in the "Power on" state.

3.2 Pairing

- 1) Press and hold touch-button for about 5s and release it when the red LED and blue LED flash quickly and alternately. The earbuds are in "Pairing" mode
- 2) When the earbuds and the cellphone fail to connect back, the earbuds will automatically enter the matching state.



3.3 Connecting

To connect any side earbud to a Bluetooth device, first ensure the device has Bluetooth enabled and it is in pairing mode (See your device manual for setting pairing mode). Then follow the below steps:

- Make sure the earbud which you want to connect is in Power Off state
- Bring the earbud into pairing mode by pressing and holding the Touch button for 5s (blue and red LED flashing alternatively) and search for it in Bluetooth List of your device
- Left-side earbud will appear as BLAUPUNKT-BTW01-L and right-side earbud will appear as BLAUPUNKT-BTW01-R
- Select the earbud in search list to pair with your Bluetooth device
- After successful pairing, blue LED of earbud will flash twice every 10s



3.4 Power off

- 1) Earbuds will auto power off once put into charging case
- 2) If earbuds are in Power On state, press and hold touch-button for 3-5s and release it till red LED is on and earbuds prompts "Power off".

Remark:

- The earbuds will automatically connect with the latest Bluetooth device when powered on again. If the earbuds are not connected, they will enter into pairing mode automatically.
- Each earbud will automatically switch to standby mode if disconnected from device (blue LED flash once every 2 seconds), and will power off automatically after 2 minutes to save power.
- The operation of single earbud is the same as that of double earbuds.

4. Earbuds Matching / TWS Mode

Please use this step if two earbuds cannot connect with each other.

4.1 Turn off both earbuds respectively (don't put them into the charging case).

4.2. Clear the pairing list: Choose one of the earbuds. First, enter into pairing mode by pressing and holding Touch button for 5s (red and blue light flashes alternatively). Then hit the touch button 5 times, the red light will turn on for 1 second. The pairing list will be cleared, and earbud will emit "Power off" after a "dang" prompt. The other earbud cleans the pairing list by doing the same.

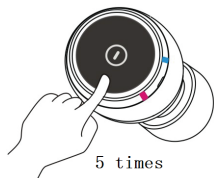

4.3 The earbuds will enter TWS / matching mode automatically when they are turned on (indicator light status: red and blue lights flash slowly). After successful connection, the master earbud (L) will emit 'Connected' and 'Pairing', after which indicator light status will be: red LED and blue LED flash alternately (it keeps waiting to be paired with your phone), while the secondary earbud (R) will emit 'Connected' and indicator status will be: blue LED flash twice time every 10 seconds.

Remarks:

- Normally both earbuds will connect with each other automatically once you have taken them out of the charging case.
- You can connect both earbuds with each other according to above operation if they fail to connect.
- TWS mode: Only left earbuds can be the master one, which can connect the right earbud and the phone's Bluetooth at the same time. When the right earbuds connect with left earbuds in the TWS mode, it cannot connect with the phone's Bluetooth.

5. Function operation-use one earbud

5.1 Answering / hang up phone calls

While incoming call (blue LED quick flash), pressing the touch button once will answer the call. Pressing the touch button during ongoing call will hang up the call.



Press touch button to answer/hang up a call

5.2 Reject calling

While incoming call (blue LED quick flash), long press the touch button for 2s and release to reject the call. You will hear an audio confirmation tone.

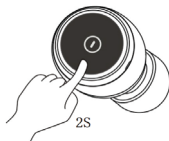

Long press touch button about 2s to reject a call

5.3 Voice assistant

After connecting your earbuds with a Bluetooth device (blue LED flash twice every 10s), short pressing the touch button 3 times (prompt 'Voice dial') will activate voice assistants like Siri.

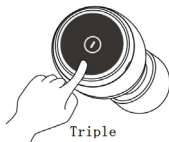

Triple press the touch button to activate voice assistant

5.4 Transfer conversation between earbuds and mobile phone

Transfer conversation to mobile phone: During a call, long press the touch button for about 2 seconds, call will be transferred to your phone and you will hear a 'dang' tone. Long press the touch button again to Transfer call to earbuds.

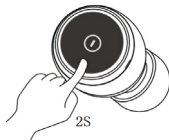

Long press touch button about 2s

5.5 Playing/Pause Music

After connecting your earbuds with a Bluetooth compatible music player, double pressing the touch button will play music, double pressing again will pause playback.

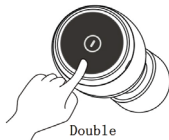

Double click

5.6 last song

Press the left earbud's touch button for about 2s while playing music.
(There is only the operation of previous song but not the operation of next song when you use the left earbud only)

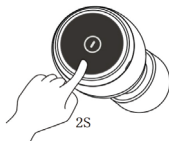

Long press left touch button about 2s

5.7 Next song

Press the right earbud's touch button for about 2s while playing music.
(There is only the operation of next song but not the operation of previous song when you use the right earbud only)

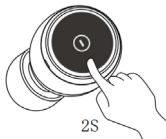

Long press right touch button about 2s

6. Function operation- two earbuds connecting with cellphone

Music and voice of operation are same for one earbud or two earbuds.

- a. If two earbuds connect with cellphone and one of the earbuds is powered off, the other one will power off also.
- b. If two earbuds connect with cellphone, any of the earbud can control play/pause/answering /rejecting phone calls and voice assistant.

Remarks:

- If earbuds are in calling mode, both earbuds will have sound and can operate function, but only the earbud which is connected with cellphone can pick up voice.

7. Battery display

When the earbuds are connected to an IOS device, it will display the battery status of earbuds on the device. When the earbuds are low on power, the battery indicator will turn red and show a depleted battery icon. The earbuds will also give an audio prompt to charge your earbuds.



Full charge

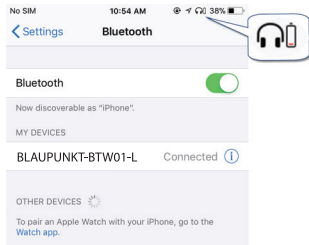

Low battery

8. Prompt tone

Status of headset	Prompt tone
Connect with phone	'Phone connected'
TWS connection	'Connected'
Low battery	Emits "Battery Low" every 2 minutes
Headset out of range	Emits "Out of rang" only once
Other earphone is out of range	Emits "Out of rang" only once

9. Factory Reset

When the earbuds are in the pairing mode, five times click the touch button, earbuds will factory reset, and the red light turns on for 1 second. At the same time, you will hear "Power off" prompt after a "dang" tone.

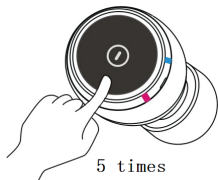

Five times click the touch button

Remarks:

- After factory reset, the paired list of two earbuds as well as earbuds and mobile phone will be deleted. The earbud does not automatically reconnect the mobile phone after turning on.
- After factory reset, when the earbuds turns on again, it will automatically enter the TWS/matching mode (red and blue lights flash slowly). Two earbuds will be paired automatically. After TWS connection, left earbud will continue to wait for pairing with the mobile phone (red and blue lights flash alternately).

• **Care and maintenance**

Read the following recommendations carefully before using BTW-01. Following these you will be able to enjoy this product for many years.

- Keep it dry and don't put it in the damp place to avoid the product's internal circuit being affected.
- Keep the product away from direct sunlight or hot places. High temperatures will shorten the life of electronic devices, destroy the battery or distort certain plastic parts.
- Don't expose the product to extreme cold areas. It may damage the internal circuit board.
- Don't try to disassemble the product as it may get damaged if you are not professional.
- Don't let it fall down onto the floor or other hard surfaces. The internal circuit might get damaged.
- Don't use intensive chemical products or detergent to clean the product.
- Don't scratch the surface with sharp things.

In case the product doesn't function properly, send it to the store you bought it from. The staff will help you to solve the problem.

• FAQs**1. What does it mean when red LED flashes four times every one minute slowly?**

Battery is low power, need to be recharged.

2. Why is the red LED off when charging?

a) The charging case may not have enough power to charge the headset. Please charge the charging case.

b) Make sure the metal contacts of the earbud and charging case are free of obstacles.

c) The battery may dry up. Please charge the battery for 30 minutes, and then the red LED will be on.

3. Why can't I hear the sound on the earbuds?

a) Make sure the volume is not too low or muted;

b) Make sure the earbuds connects with the mobile phone correctly;

c) Make sure the distance between the earbuds and the cell phone is in the available Bluetooth range.

4. Why can't I hear the sound clearly on the earbuds?

a) Make sure the mobile phone is in the strong signal area;

b) Make sure the earbuds is in the available range. and no other block.

5. Why the pause/play, last/next song not function when playing music?

Make sure your Bluetooth device supports AVRCP (Audio/Video Remote Control profile)

• Specifications

Bluetooth version	Bluetooth V5.0
Bluetooth profiles	HFP, HSP,A2DP and AVRCP
Operating distance	10 meters
Music time(one earbud)	Up to 6.5 hours
Music time(two earbuds)	Up to 5 hours (maximum volume)
	Up to 8.5 hours (50% volume)
Talk time	Up to 6.0 hours
Standby time	About 130 hours
Charging time for earbud	About 1.5 hours
Charging time for case	About 1.5 hours
Charging input	DC 5.0V /500mA
Weight	One earbud:5.5 g
	Charging case:29g
Measure	Earbud:23.5*17.2*24.7mm
	Charging case:58*25*36mm

• Warranty Information 1 Year*

If you have issue with our BTW-01 product please contact our service center.

Authorized Service Center Blaupunkt Speakers

Address: Envent World Wide Pvt. Ltd.,

Khasra No- 15/15 (4-16), Village Samalkha, Tehsil Vasant Vihar, New Delhi-110037. E-Mail: wecare@blaupunkt-audio.in

Tel: 1800 843 4333

Please prepare and submit the following information during the telephone or e-mail notification to facilitate the process:

- Serial number
- Date of purchase
- A copy of proof of purchase in case of warranty

Note - Important information:

Please use the original packaging or other suitable packaging to protect the unit in transit.