

CLEARLITE

BATHROOMS

SHOWERS | VANITIES | BATHS | ACCESSORIES

VOLUME 23

2nd Edition



From our hands



to yours

CLEARLITE
for life

clearlite.co.nz

CLEARLITE

BATHROOMS

TRUSTED NATIONWIDE

Established in 1946 manufacturing a various range of products, Clearlite is a trusted supplier of quality bathroomware. The majority of our products are designed and manufactured right here in New Zealand for Kiwi Families.

With over 50 years' experience in the bathroom industry, our aim at Clearlite is to provide a selection of Showers, Vanities, Mirrors, Bathroom Furniture and Baths to suit the style needs and budgets of all New Zealanders.

MADE IN NEW ZEALAND

We are a New Zealand company who believe in manufacturing quality products using trusted raw materials. This helps to ensure our products not only look good but stand the test of time. The majority of our product range is designed and manufactured here in New Zealand. We also import a selection of products; some of which we design ourselves to complement our core range. All products are subject to quality control checks before dispatch.

CLEARLITE.CO.NZ

We recommend you visit the Clearlite website to help with the planning of your new home or bathroom renovation project. Our website is packed with helpful information from printable technical drawings and installation instructions to product images which are all on hand to assist with your bathroom product selection.

WHERE TO ORDER

Clearlite bathroomware is available from leading plumbing merchants and retailers nationwide. Find your nearest supplier at clearlite.co.nz/pages/retailers

RECOMMENDED RETAIL PRICES

Download the latest RRP Price List for all Clearlite products online at clearlite.co.nz/pages/catalogues

AFTER SALES SUPPORT & CUSTOMER CARE

We care about the longevity of our products and ensuring you get the most from your Clearlite bathroomware. So, if you need to replace a part, request a product service or speak with a team member, contact us today. Phone 09 444 3780 Email info@clearlite.co.nz

SUPPORTING NEW ZEALAND FAMILIES

Every week, families arrive at hospitals away from their homes with a child in need of urgent medical treatment. Ronald McDonald Houses Auckland provide a 'home-away-from-home', offering families a safe haven to retreat to, after a long day on the ward. Clearlite Bathrooms are proud to give back to our community by supporting these New Zealand families. Learn more at rmhc.org.nz

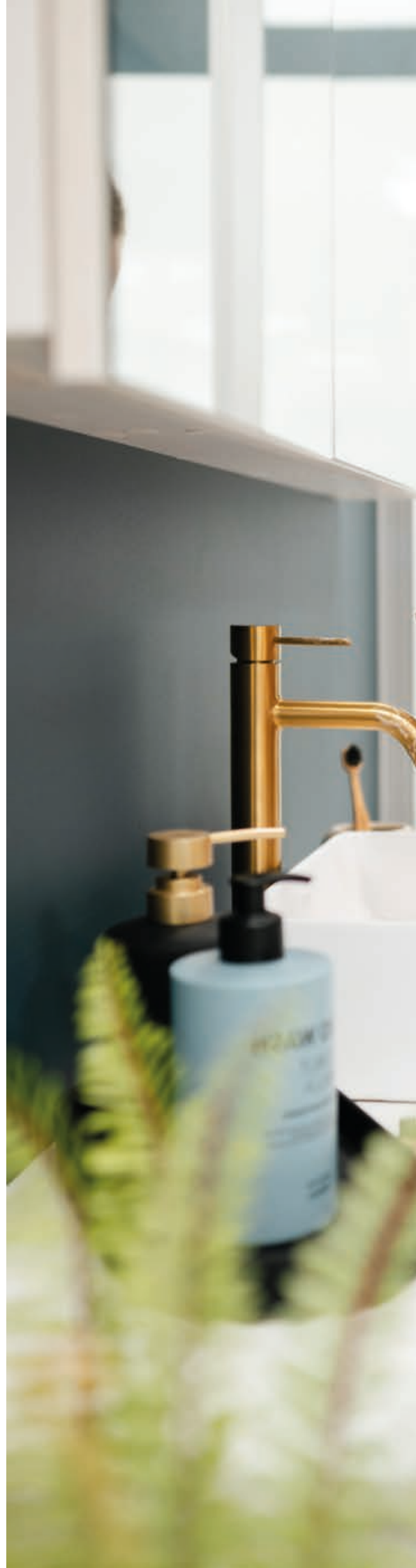



SHOWERS 4

Sierra 7
 Cezanne Round 10
 Diamond Fusion® 10
 Cezanne Square 12
 Millennium 14
 Pacific 18
 Platinum Shower Screens 20
 Trombone 21

VANITIES, MIRRORS & STORAGE 22

Cabinet Handles 24
 Cabinet Finishes 25

VANITY RANGE

Basins 26
 Cashmere Pro Series 27
 Pinnacle Pro Series 28
 Nikau Pro Series 29
 Statesman 30
 Cashmere 32
 Cashmere Slim 34
 Pinnacle 36
 Pinnacle Slim 38
 Bolero 40
 Norfolk 42
 Raglan 44
 Nikau 46
 Pacific 48

Hand Basins 50
 Mirrors & Storage 52
 Storage Towers 54

BATHS & ACCESSORIES 56

Back to Wall Bath 58
 Drop In Baths 60
 Shower over Bath 64
 ShowerMaster Accessories 66

Warranties & Maintenance 67
 Bathroom Planner 68

Warranty Product	Warranty Period*
Shower door set, acrylic wall liner, Sure Seal™ tray and EasyClean Waste body	10 Years
Shower drip strips, vertical seals and waste lid	1 Year
Vanity and Basin	5 Years
Mirror	2 Years
Storage Tower and Mirror Cabinet	5 Years
Bath	5 Years
Commercial Use	1 Year

Refer page 65 for full warranty details.

SHOWERS

Clearlite showers are available in a selection of styles, sizes and configurations to suit any New Zealand bathroom. Our showers are constructed from the highest quality materials and are designed to enhance product longevity.

Clearlite acrylic shower trays, wall liners and door sets* are proudly manufactured in New Zealand. *excluding our imported Cezanne sliding door set

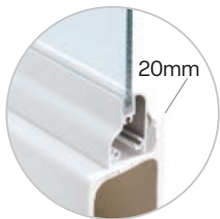

SURE SEAL™ TRAY

The unique design of the Sure Seal™ Tray offers a full 20mm upstand around the perimeter of the shower. Both door and liner are installed within the tray so water flows back into tray whilst in use.

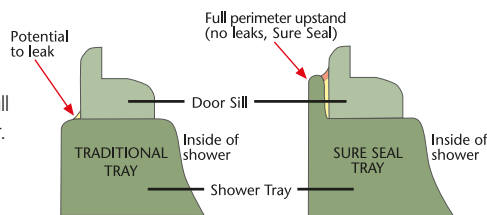

EASY CLEAN WASTE

All Clearlite shower trays include a chrome or white lid Easy Clean Waste kit. When correctly installed this system allows you to simply lift the waste cover and inner cup for cleaning.



SENOSAN ACRYLIC LINERS

Clearlite showers use Senosan from Senoplast that brings you an unbeatable advantage of:

- Brilliant surface of sanitary acrylic
- Warm surface
- Long life in use
- Excellent design possibilities



SAFETY GLASS

Bathroom projects may need to obtain a code of compliance. All Clearlite Showers are manufactured with this in mind and use toughened safety glass complying with AS/NZS2208.



CLEANING & MAINTENANCE

- Wipe down the shower or use a squeegee to remove excess water from the glass after use
- Use a trusted glass cleaner on shower glass and bath screens to remove soap deposits
- Consider Diamond Fusion to make glass cleaning easier. See page 10
- Clean the shower tray and liner surfaces using the Vibrance Surface Cleaner
- Waste lid and cup should be removed and cleaned regularly
- Remove and clean drip seals on a regular basis





Sierra 900x900 Angle Corner Flat Wall Black
Nikau 1000 Double Drawer Floor Ultra Gloss White and Triple Duck Egg



Sierra 1200x900 2 Sided Moulded Wall White
Pinnacle 900 Drawer Open Wall Baroque



Sierra Square 1000x1000 Tiled Wall Satin with Optional Glass Shelves

DOORS & RETURNS

- Full length aluminium handle incorporating magnetic door closure
- Door can be left or right hand opening
 - Door can be positioned on either side of 2 Sided Square showers
 - White or satin or black joinery
 - Minimalist 5mm semi-frameless returns complying to AS/NZS 2208
 - 6mm Safety glass door complying to AS/NZS 2208
 - Square pivot covers (Chrome with White and Satin joinery or Black)
 - Optional Diamond Fusion™ treatment available (see page 10)

WALLS

ACRYLIC

- Flat, side moulded or corner moulded one piece wall lining

TILED

- Suitable for tiled walls when wall receivers are installed to waterproofing prior to tiling

Optional glass shelves and footrest available (see page 66)

TRAYS

70mm Sure Seal Shower Tray, see page 4

- Chrome Easy Clean Waste (white waste cover with black joinery)
- Showerbond adhesive is supplied for ease of installation

1970mm height: door set on the tray

All dimensions are nominal

10 Year Warranty on door set, acrylic wall liner, SureSeal™ tray and EasyClean Waste body

12 month warranty on drip strips and vertical seals

Made in New Zealand

JOINERY OPTIONS



The black anodized finish is achieved through an electrochemical process that transforms the metal surface, providing durability and a decorative finish. Next, a sealing process is applied to all black joinery surfaces, offering high corrosion resistance, resistance to fingerprints, and easy cleaning, enhancing overall performance.

SIZING OPTIONS See pages 8&9 for specification details

	760x900	900x760	900x900	1000x1000	900x1000	1000x900	900x1200	1200x900
SIERRA - 2 SIDED								
Centre Waste	•	•	•	•	•	•	•	•
Corner Waste			•	•				
SIERRA - 3 SIDED								
Centre Waste	•	•	•	•	•	•	•	•
Corner Waste			•	•				
SIERRA - ANGLE CORNER								
Centre Waste			•	•				

SIERRA - 2 SIDED

WHEN ORDERING:

Complete your chosen product code below by specifying one of the below joinery codes in the blank space within the code _
Use **W** for White; **S** for Satin; **K** for Black

2 SIDED - CENTRE WASTE

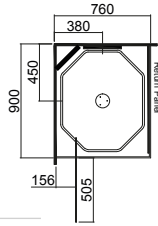

900 x 760 (760 door)
(Left Hand Moulding)

FLAT WALL	ISI2_97SFL7X
SIDE MOULDED	ISI2_97SMZ7X
CORNER MOULD	ISI2_97SMC7X
TILED WALL	ISI2_97STL7X

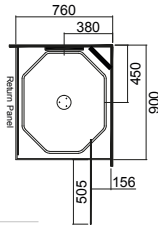

900 x 760 (760 door)
(Right Hand Moulding)

FLAT WALL	ISI2_97SFL7X
SIDE MOULDED	ISI2_97SMZ7X
CORNER MOULD	ISI2_97SMC7X
TILED WALL	ISI2_97STL7X

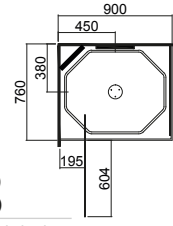

900 x 760 (900 door)
(Left Hand Moulding)

FLAT WALL	ISI2_97SFL9X
SIDE MOULDED	ISI2_97SMY9X
CORNER MOULD	ISI2_97SMC9X
TILED WALL	ISI2_97STL9 X

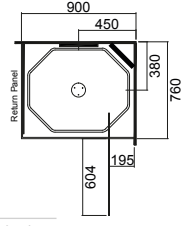

900 x 760 (900 door)
(Right Hand Moulding)

FLAT WALL	ISI2_97SFL9X
SIDE MOULDED	ISI2_97SMY9X
CORNER MOULD	ISI2_97SMC9X
TILED WALL	ISI2_97STL9 X

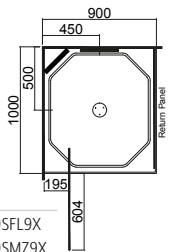

1000 x 900 (900 door)
(Left Hand Moulding)

FLAT WALL	ISI2_19SFL9X
SIDE MOULDED	ISI2_19SMZ9X
CORNER MOULD	ISI2_19SMC9X
TILED WALL	ISI2_19STL9X

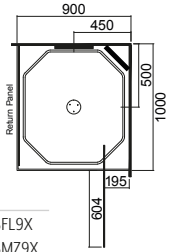

1000 x 900 (900 door)
(Right Hand Moulding)

FLAT WALL	ISI2_19SFL9X
SIDE MOULDED	ISI2_19SMZ9X
CORNER MOULD	ISI2_19SMC9X
TILED WALL	ISI2_19STL9X

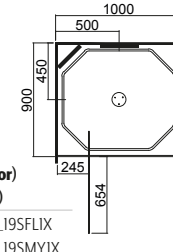

1000 x 900 (1000 door)
(Left Hand Moulding)

FLAT WALL	ISI2_19SFLIX
SIDE MOULDED	ISI2_19SMYIX
CORNER MOULD	ISI2_19SMCIX
TILED WALL	ISI2_19STLIX

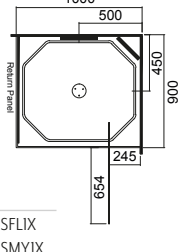

1000 x 900 (1000 door)
(Right Hand Moulding)

FLAT WALL	ISI2_19SFLIX
SIDE MOULDED	ISI2_19SMYIX
CORNER MOULD	ISI2_19SMCIX
TILED WALL	ISI2_19STLIX

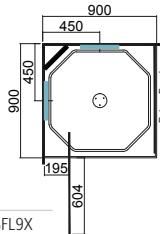

900 x 900

FLAT WALL	ISI2_99SFL9X
SIDE MOULDED	ISI2_99SMS9X
CORNER MOULD	ISI2_99SMC9X
TILED WALL	ISI2_99STL9X

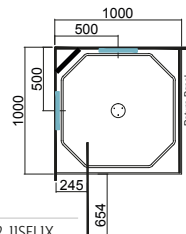

1000 x 1000

FLAT WALL	ISI2_11SFLIX
SIDE MOULDED	ISI2_11SMSIX
CORNER MOULD	ISI2_11SMCIX
TILED WALL	ISI2_11STLIX

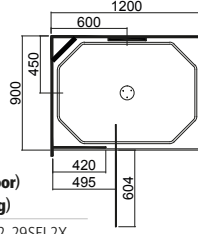

1200 x 900 (1200 door)
(Left Hand Moulding)

FLAT WALL	ISI2_29SFL2X
SIDE MOULDED	ISI2_29SMY2X
CORNER MOULD	ISI2_29SMC2X
TILED WALL	ISI2_29STL2X

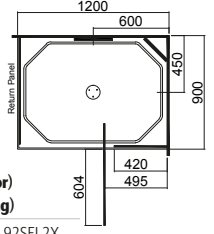

1200 x 900 (1200 door)
(Right Hand Moulding)

FLAT WALL	ISI2_29SFL2X
SIDE MOULDED	ISI2_29SMY2X
CORNER MOULD	ISI2_29SMC2X
TILED WALL	ISI2_29STL2X

2 SIDED - CORNER WASTE

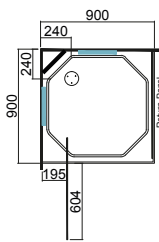

900 x 900

FLAT WALL	ISI2_99SFL9C
SIDE MOULDED	ISI2_99SMS9C
CORNER MOULD	ISI2_99SMC9C
TILED WALL	ISI2_99STL9C

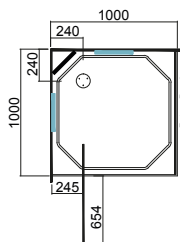

1000 x 1000

FLAT WALL	ISI2_11SFLIC
SIDE MOULDED	ISI2_11SMSIC
CORNER MOULD	ISI2_11SMCIC
TILED WALL	ISI2_11STLIC

2 SIDED - ANGLE CORNER - CENTRE WASTE

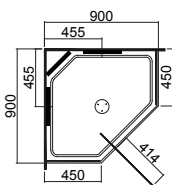

900 x 900

FLAT WALL	ISI2_99CFL9X
SIDE MOULDED	ISI2_99CMS9X
CORNER MOULD	ISI2_99CMC9X
TILED WALL	ISI2_99CTL9X

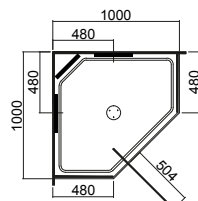

1000 x 1000

FLAT WALL	ISI2_11CFLIX
SIDE MOULDED	ISI2_11CMSIX
CORNER MOULD	ISI2_11CMCIX
TILED WALL	ISI2_11CTLIX

■ Fixed position moulded shelving wall liner ■ Reversible moulded shelving wall liner

WHEN ORDERING:

Complete your chosen product code below by specifying one of the below joinery codes in the blank space within the code __
Use **W** for White; **S** for Satin; **K** for Black

3 SIDED - CENTRE WASTE

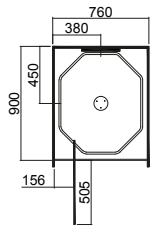

900 x 760 (760 door)

FLAT WALL IS12_979FL7X
MOULDED WALL IS12_979MB7X
TILED WALL IS12_979TL9X

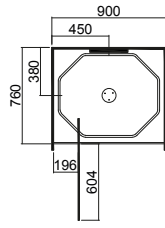

900 x 760 (900 Door)

FLAT WALL IS12_797FL9X
MOULDED WALL IS12_797MB9X
TILED WALL IS12_797TL9X

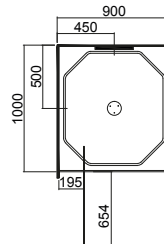

1000 x 900 (900 door)

FLAT WALL IS12_191FL9X
MOULDED WALL IS12_191MB9X
TILED WALL IS12_191TL9X

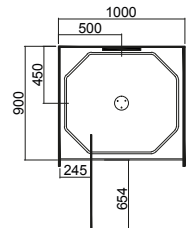

1000 x 900 (1000 door)

FLAT WALL IS12_919FLIX
MOULDED WALL IS12_919MBIX
TILED WALL IS12_919TLIX

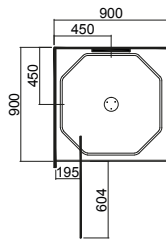

900 x 900

FLAT WALL IS12_999FL9X
MOULDED WALL IS12_999MB9X
TILED WALL IS12_999TL9X

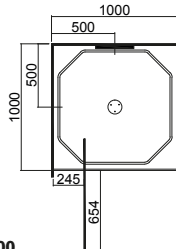

1000 x 1000

FLAT WALL IS12_111FLIX
MOULDED WALL IS12_111MBIX
TILED WALL IS12_111TLIX

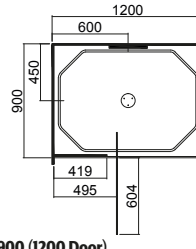

1200 x 900 (1200 Door)

FLAT WALL IS12_929FL2X
MOULDED WALL IS12_929MB2X
TILED WALL IS12_929TL2X

3 SIDED - CORNER WASTE

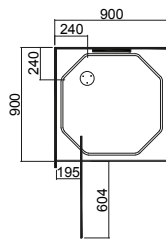

900 x 900

FLAT WALL IS12_999FL9C
MOULDED WALL IS12_999MB9C
TILED WALL IS12_999TL9C

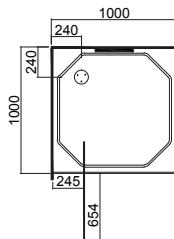

1000 x 1000

FLAT WALL IS12_111FLIC
MOULDED WALL IS12_111MBIC
TILED WALL IS12_111TLIC

CEZANNE ROUND

WHEN ORDERING:

Complete your chosen product code below by specifying one of the below joinery codes in the blank space within the code __
Use **W** for White; **B** for Bright

2 SIDED - CENTRE WASTE

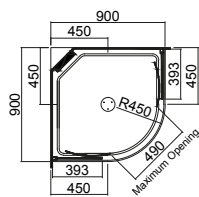

900 x 900

FLAT WALL ICZ2_99RFLRX
MOULDED WALL ICZ2_99RMCRCX
TILED WALL ICZ2_99RTLTX

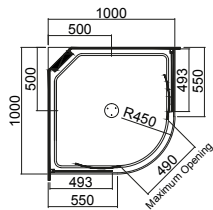

1000 x 1000

FLAT WALL ICZ2_11RFLRX
MOULDED WALL ICZ2_11RMCRCX
TILED WALL ICZ2_11RTLTX

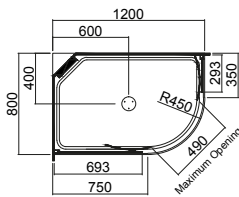

800 x 1200

FLAT WALL ICZ2_82RFLRX
MOULDED WALL ICZ2_82RMCRCX
TILED WALL ICZ2_82RTLTX

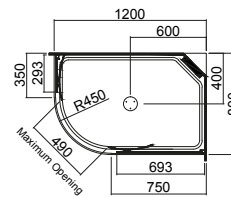

1200 x 800

FLAT WALL ICZ2_28RFLRX
MOULDED WALL ICZ2_28RMCRCX
TILED WALL ICZ2_28RTLTX

2 SIDED - CORNER WASTE

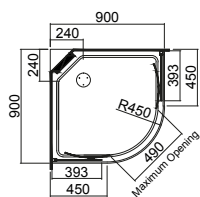

900 x 900

FLAT WALL ICZ2_99RFLRC
MOULDED WALL ICZ2_99RMCRC
TILED WALL ICZ2_99RTLRC

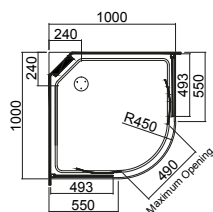

1000 x 1000

FLAT WALL ICZ2_11RFLRC
MOULDED WALL ICZ2_11RMCRC
TILED WALL ICZ2_11RTLRC

■ Fixed position moulded shelving wall liner

DIAMOND FUSION GLASS DEFENDER

HOW DOES IT WORK?

Glass is not as smooth as you might think – it is actually quite a porous surface which makes an ideal setting for soap residue, dirt and mineral build ups to reside which, over time can result in a cloudy or noticeably dull appearance. Diamond Fusion Glass Defender works in two stages to protect your glass from these impurities. The first stage “Fills in” the rough, porous surface of the glass and the second stage “Caps” the previous layer with an optically clear material which makes the surface significantly easier to clean and resistant to weathering.

LIFETIME WARRANTY

Diamond Fusion Glass Defender offers an instant 1 year warranty. Via a simple on-line registration customers can extend this to a LIFETIME WARRANTY, which is backed by a NZ wide agent network.

For more information contact
Diamond Fusion on 0800 667278
or visit diamondfusion.co.nz

* Factory treatment is available for Sierra, Millennium and Trombone shower doors and returns. If you would like your Cezanne shower treated please contact Diamond Fusion for post installation treatment.



Cezanne Round 1000x1000 2 Sided Moulded Wall White

DOORS & RETURNS

Space saving sliding doors with magnetic door closure

- Contemporary square bar double sided pull handles
- White or Bright Joinery
- 6mm safety glass door complying to AS/NZS2208
- Child proof safety locking feature to prevent accidental release of doors
- Long return panels for increased internal showering space
- Minimal overlapping glass panels for trouble free cleaning
 - Quick release double roller door system for easy cleaning

WALLS

ACRYLIC

- One piece Senosan® wall lining
- Optional moulded wall features corner soap recess with foot rest

TILED

- Suitable for tiled walls when wall receivers are installed to waterproofing prior to tiling

Optional glass shelves and footrest available (see page 66)

TRAYS

70mm Sure Seal Shower Tray, see page 4

- Chrome Easy Clean Waste
- Showerbond adhesive is supplied for ease of installation



Cezanne 900x900 Tiled Wall Bright with optional Glass Shelves

1970mm height: door set on the tray

All dimensions are nominal

10 Year Warranty on door set, acrylic wall liner, SureSeal™ tray and EasyClean Waste body

12 month warranty on drip strips and vertical seals

JOINERY OPTIONS

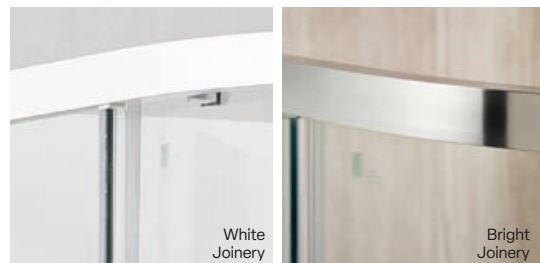

White Joinery

Bright Joinery

SIZING OPTIONS See page 10 for specification details

	900x900	1000x1000	800x1200	1200x800
CEZANNE ROUND -2 SIDED				
Centre Waste	•	•	•	•
Corner Waste	•	•		

CEZANNE SQUARE

WHEN ORDERING:

Complete your chosen product code below by specifying one of the below joinery codes in the blank space within the code __
Use **W** for White; **B** for Bright

2 SIDED - CENTRE WASTE

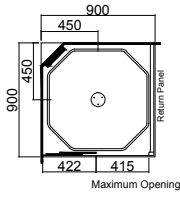

900 x 900

FLAT WALL	ICZ2_99SFL9X
MOULDED WALL	ICZ2_99SMC9X
TILED WALL	ICZ2_99STL9X

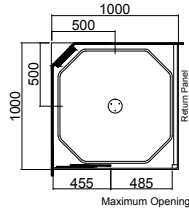

1000 x 1000

FLAT WALL	ICZ2_10ISFLIX
MOULDED WALL	ICZ2_10ISMCIX
TILED WALL	ICZ2_10ISTLIX

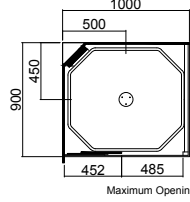

900 x 1000 (1000 Door) (Left Hand Moulding)

FLAT WALL	ICZ2_19SFLIX
MOULDED WALL	ICZ2_19SMCIX
TILED WALL	ICZ2_19STLIX

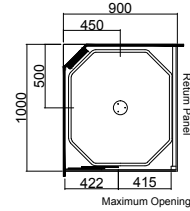

1000 x 900 (900 Door) (Left Hand Moulding)

FLAT WALL	ICZ2_19SFL9X
MOULDED WALL	ICZ2_19SMC9X
TILED WALL	ICZ2_19STL9X

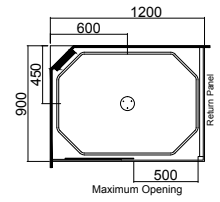

1200 x 900 (1200 door) (Left Hand Moulding)

FLAT WALL	ICZ3_29SFL2X
MOULDED WALL	ICZ3_29SMC2X
TILED WALL	ICZ3_29STL2X

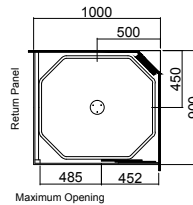

900 x 1000 (1000 Door) (Right Hand Moulding)

FLAT WALL	ICZ2_19SFLIX
MOULDED WALL	ICZ2_19SMCIX
TILED WALL	ICZ2_19STLIX

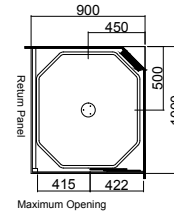

1000 x 900 (900 Door) (Right Hand Moulding)

FLAT WALL	ICZ2_19SFL9X
MOULDED WALL	ICZ2_19SMC9X
TILED WALL	ICZ2_19STL9X

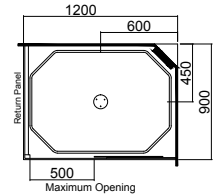

1200 x 900 (1200 door) (Right Hand Moulding)

FLAT WALL	ICZ3_29SFL2X
MOULDED WALL	ICZ3_29SMC2X
TILED WALL	ICZ3_29STL2X

2 SIDED - CORNER WASTE

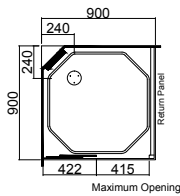

900 x 900

FLAT WALL	ICZ2_99SFL9C
MOULDED WALL	ICZ2_99SMC9C
TILED WALL	ICZ2_99STL9C

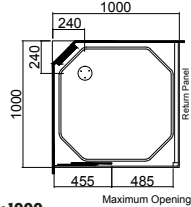

1000 x 1000

FLAT WALL	ICZ2_10ISFLIC
MOULDED WALL	ICZ2_10ISMCIC
TILED WALL	ICZ2_10ISTLIC

900 x 1000 (1000 Door) (Right Hand Moulding)

FLAT WALL	ICZ2_19SFLIX
MOULDED WALL	ICZ2_19SMCIX
TILED WALL	ICZ2_19STLIX

1000 x 900 (900 Door) (Right Hand Moulding)

FLAT WALL	ICZ2_19SFL9X
MOULDED WALL	ICZ2_19SMC9X
TILED WALL	ICZ2_19STL9X

1200 x 900 (1200 door) (Right Hand Moulding)

FLAT WALL	ICZ3_29SFL2X
MOULDED WALL	ICZ3_29SMC2X
TILED WALL	ICZ3_29STL2X

3 SIDED - CENTRE WASTE

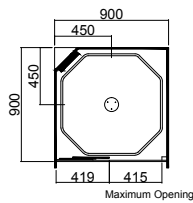

900 x 900 (Left Hand Moulding)

FLAT WALL	ICZ2_999FL9X
MOULDED WALL	ICZ2_999ML9X
TILED WALL	ICZ2_999TL9X

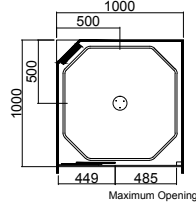

1000 x 1000 (Left Hand Moulding)

FLAT WALL	ICZ2_10IIFLIX
MOULDED WALL	ICZ2_10IIMLIX
TILED WALL	ICZ2_10IITLIX

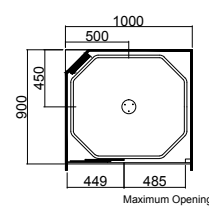

900 x 1000 (Left Hand Moulding)

FLAT WALL	ICZ2_919FLIX
MOULDED WALL	ICZ2_919MLIX
TILED WALL	ICZ2_919TLIX

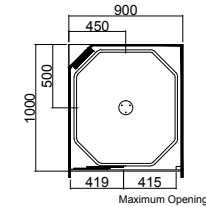

1000 x 900 (Left Hand Moulding)

FLAT WALL	ICZ2_191FL9X
MOULDED WALL	ICZ2_191ML9X
TILED WALL	ICZ2_191TL9X

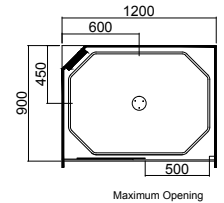

1200 x 900 (Left Hand Moulding)

FLAT WALL	ICZ3_929FL2X
MOULDED WALL	ICZ3_929ML2X
TILED WALL	ICZ3_929TL2X

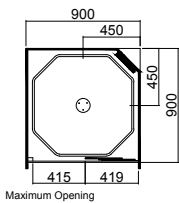

900 x 900 (Right Hand Moulding)

FLAT WALL	ICZ2_999FL9X
MOULDED WALL	ICZ2_999MR9X
TILED WALL	ICZ2_999TL9X

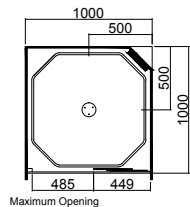

1000 x 1000 (Right Hand Moulding)

FLAT WALL	ICZ2_10IIFLIX
MOULDED WALL	ICZ2_10IIMRIX
TILED WALL	ICZ2_10IITLIX

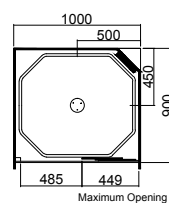

900 x 1000 (Right Hand Moulding)

FLAT WALL	ICZ2_919FLIX
MOULDED WALL	ICZ2_919MRIX
TILED WALL	ICZ2_919TLIX

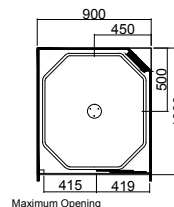

1000 x 900 (Right Hand Moulding)

FLAT WALL	ICZ2_191FL9X
MOULDED WALL	ICZ2_191MR9X
TILED WALL	ICZ2_191TL9X

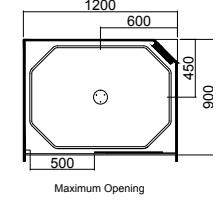

1200 x 900 (Right Hand Moulding)

FLAT WALL	ICZ3_929FL2X
MOULDED WALL	ICZ3_929MR2X
TILED WALL	ICZ3_929TL2X

3 SIDED - CORNER WASTE

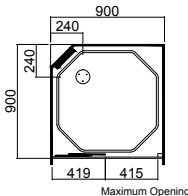

900 x 900 (Left Hand Moulding)

FLAT WALL	ICZ2_999FL9C
MOULDED WALL	ICZ2_999ML9C
TILED WALL	ICZ2_999TL9C

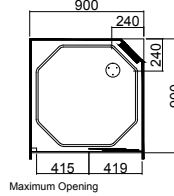

900 x 900 (Right Hand Moulding)

FLAT WALL	ICZ2_999FL9C
MOULDED WALL	ICZ2_999MR9C
TILED WALL	ICZ2_999TL9C

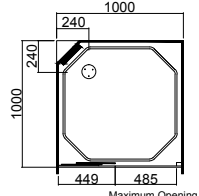

1000 x 1000 (Left Hand Moulding)

FLAT WALL	ICZ2_10IIFLIC
MOULDED WALL	ICZ2_10IIMLIC
TILED WALL	ICZ2_10IITLIC

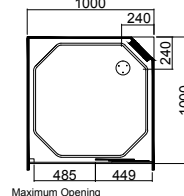

1000 x 1000 (Right Hand Moulding)

FLAT WALL	ICZ2_10IIFLIC
MOULDED WALL	ICZ2_10IIMRIC
TILED WALL	ICZ2_10IITLIC



Cezanne 900x900 2 Sided Custom Moulded Wall White

DOORS & RETURNS

Space saving 2 or 3 panel sliding doors with magnetic door closure

- Contemporary square bar double sided pull handles
- White or Bright Joinery
- 6mm safety glass door complying to AS/NZS2208
- Child proof safety locking feature to prevent accidental release of doors
- Minimal overlapping glass panels for trouble free cleaning
 - Quick release double roller door system for easy cleaning

WALLS

ACRYLIC

- One piece Senosan® wall lining
- Optional moulded wall features corner soap recess with foot rest

TILED

- Suitable for tiled walls when wall receivers are installed to waterproofing prior to tiling

Optional glass shelves and footrest available (see page 66)

TRAYS

70mm Sure Seal Shower Tray, see page 4

- Chrome Easy Clean Waste
- Showerbond adhesive is supplied for ease of installation

1970mm height: door set on the tray

All dimensions are nominal

10 Year Warranty on door set, acrylic wall liner, SureSeal™ tray and EasyClean Waste body

12 month warranty on drip strips and vertical seals



Cezanne Square 1000x1000 Alcove Tiled Wall White

JOINERY OPTIONS

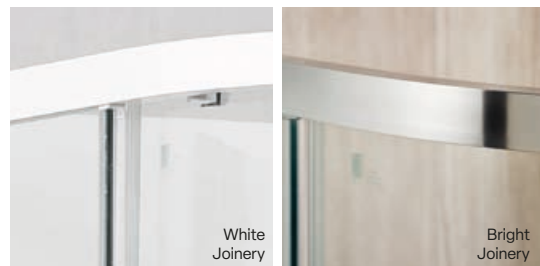

SIZING OPTIONS See page 12 for specification details

	900x900 3 Panel Door	1000x1000 3 Panel Door	900x1000 3 Panel Door	1000x900 3 Panel Door	900x1200 2 Panel Door	1200x900 2 Panel Door
CEZANNE SQUARE -2 SIDED						
Centre Waste	•	•	•	•	•	•
Corner Waste	•	•				
CEZANNE SQUARE -3 SIDED						
Centre Waste	•	•	•	•	•	•
Corner Waste	•	•				





Millennium 1200x900 2 Sided Moulded Wall Satin

DOORS & RETURNS

Magnetic door closure with contemporary handle

- Door can be left or right hand opening
- Door can be positioned on either side of 2 Sided Square showers
- White or satin or black joinery
- Minimalist 5mm semi-frameless returns complying to AS/NZS 2208
- 6mm Safety glass door complying to AS/NZS 2208
- Chrome or Black pivot covers
- Optional Diamond Fusion™ treatment available (see page 10)

WALLS

ACRYLIC

Flat or moulded one piece wall lining

- Optional moulded wall features corner soap recesses with foot rest
- Moulding can be in the left or right hand corner of 3 sided showers

TILED

- Suitable for tiled walls when wall receivers are installed to waterproofing prior to tiling

Optional glass shelves and footrest available (see page 66)

TRAYS

70mm Sure Seal Shower Tray, see page 4

- Chrome Easy Clean Waste
- Showerbond adhesive is supplied for ease of installation

2050mm height: door set on the tray

All dimensions are nominal

10 Year Warranty on door set, acrylic wall liner, SureSeal™ tray and EasyClean Waste body

12 month warranty on drip strips and vertical seals

Made in New Zealand



Millennium 900x900 2 Sided Tiled Wall Satin with Glass Shelves

JOINERY OPTIONS



SIZING OPTIONS See pages 14 & 15 for specification details

	900x900	1000x1000	NEW SIZE 900x1000	NEW SIZE 1000x900	900x1200	1200x900
MILLENNIUM - 2 SIDED						
Centre Waste	•	•	•	•	•	•
Corner Waste	•	•				
MILLENNIUM - 3 SIDED						
Centre Waste	•	•	•	•	•	•
Corner Waste	•	•				
MILLENNIUM - ANGLED CORNER						
Centre Waste		•				

MILLENNIUM - 2 SIDED

WHEN ORDERING:

Complete your chosen product code below by specifying one of the below joinery codes in the blank space within the code ...
Use **W** for White; **S** for Satin; **K** for Black

2 SIDED - CENTRE WASTE

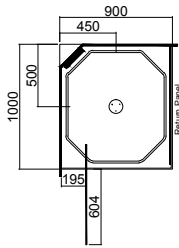

1000 x 900 (900 Door) (Left Hand Moulding)

FLAT WALL IML2.19SFL9X
MOULDED WALL IML2.19SMC9X
TILED WALL IML2.19STL9X

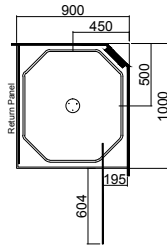

1000 x 900 (900 Door) (Right Hand Moulding)

FLAT WALL IML2.19SFL9X
MOULDED WALL IML2.19SMC9X
TILED WALL IML2.19STL9X

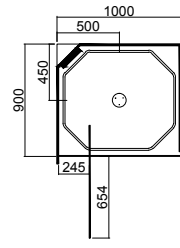

1000 x 900 (1000 door) (Left Hand Moulding)

FLAT WALL IML2.19SFL1X
MOULDED WALL IML2.19SMC1X
TILED WALL IML2.19STL1X

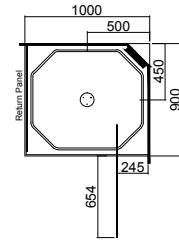

1000 x 900 (1000 Door) (Right Hand Moulding)

FLAT WALL IML2.19SFL1X
MOULDED WALL IML2.19SMC1X
TILED WALL IML2.19STL1X

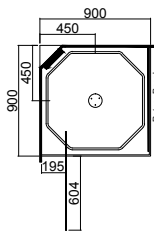

900 x 900

FLAT WALL IML2.99SFL9X
MOULDED WALL IML2.99SMC9X
TILED WALL IML2.99STL9X

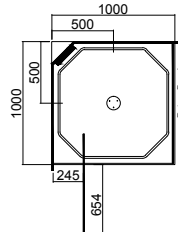

1000 x 1000

FLAT WALL IML2.11SFL1X
MOULDED WALL IML2.11SMC1X
TILED WALL IML2.11STL1X

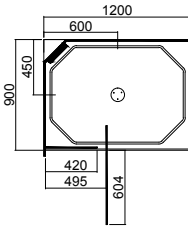

1200 x 900 (Left Hand Moulding)

FLAT WALL IML2.29SFL2X
MOULDED WALL IML2.29SMC2X
TILED WALL IML2.29STL2X

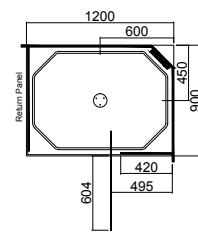

1200 x 900 (Right Hand Moulding)

FLAT WALL IML2.29SFL2X
MOULDED WALL IML2.29SMC2X
TILED WALL IML2.29STL2X

2 SIDED - CORNER WASTE

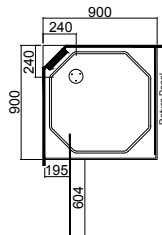

900 x 900

FLAT WALL IML2.99SFL9C
MOULDED WALL IML2.99SMC9C
TILED WALL IML2.99STL9C

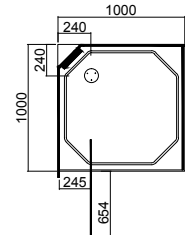

1000 x 1000

FLAT WALL IML2.11SFL1C
MOULDED WALL IML2.11SMC1C
TILED WALL IML2.11STL1C

2 SIDED - ANGLE CORNER - CENTRE WASTE

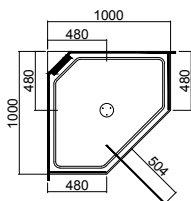

1000 x 1000

FLAT WALL IML2.11CFL1X
MOULDED WALL IML2.11CMC1X
TILED WALL IML2.11CTL1X

WHEN ORDERING:

Complete your chosen product code below by specifying one of the below joinery codes in the blank space within the code ...
Use **W** for White; **S** for Satin; **K** for Black

3 SIDED - CENTRE WASTE

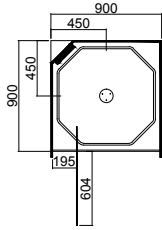

900 x 900 (Left Hand Moulding)

FLAT WALL IML2_999FL9X
MOULDED WALL IML2_999ML9X
TILED WALL IML2_999TL9X

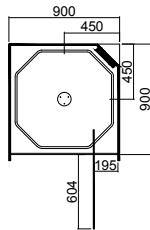

900 x 900 (Right Hand Moulding)

FLAT WALL IML2_999FL9X
MOULDED WALL IML2_999MR9X
TILED WALL IML2_999TL9X

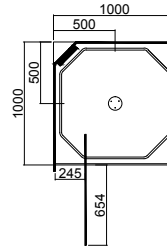

1000 x 1000 (Left Hand Moulding)

FLAT WALL IML2_111FLIX
MOULDED WALL IML2_111MLIX
TILED WALL IML2_111TLIX

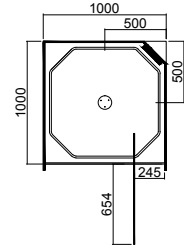

1000 x 1000 (Right Hand Moulding)

FLAT WALL IML2_111FLIX
MOULDED WALL IML2_111MRIX
TILED WALL IML2_111TLIX

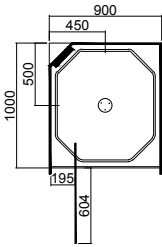

**1000 x 900 (900 Door)
(Left Hand Moulding)**

FLAT WALL IML2_919FL9X
MOULDED WALL IML2_919ML9X
TILED WALL IML2_919TL2X

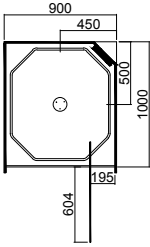

**1000 x 900 (900 Door)
(Right Hand Moulding)**

FLAT WALL IML2_919FL9X
MOULDED WALL IML2_919MR9X
TILED WALL IML2_919TL2X

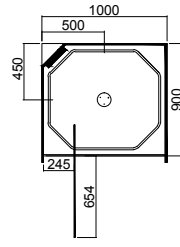

**900 x 1000 (1000 Door)
(Left Hand Moulding)**

FLAT WALL IML2_919FLIX
MOULDED WALL IML2_919MLIX
TILED WALL IML2_919TL9X

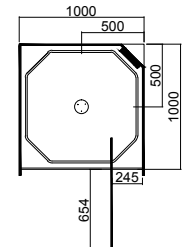

**900 x 1000 (1000 Door)
(Right Hand Moulding)**

FLAT WALL IML2_919FLIX
MOULDED WALL IML2_919MRIX
TILED WALL IML2_919TL9X

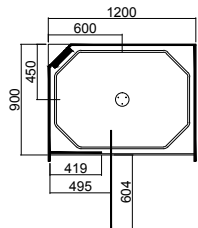

1200 x 900 (Left Hand Moulding)

FLAT WALL IML2_929FL2X
MOULDED WALL IML2_929ML2X
TILED WALL IML2_929TL2X

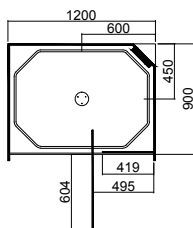

1200 x 900 (Right Hand Moulding)

FLAT WALL IML2_929FL2X
MOULDED WALL IML2_929MR2X
TILED WALL IML2_929TL2X

3 SIDED - CORNER WASTE

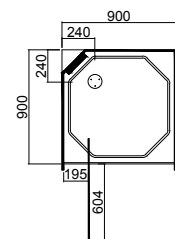

900 x 900 (Left Hand Moulding)

FLAT WALL IML2_999FL9C
MOULDED WALL IML2_999ML9C
TILED WALL IML2_999TL9C

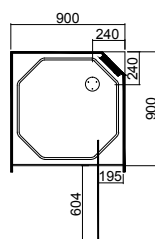

900 x 900 (Right Hand Moulding)

FLAT WALL IML2_999FL9C
MOULDED WALL IML2_999MR9C
TILED WALL IML2_999TL9C

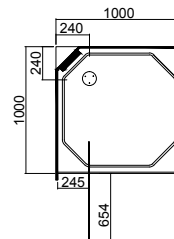

1000 x 1000 (Left Hand Moulding)

FLAT WALL IML2_111FLIC
MOULDED WALL IML2_111MLIC
TILED WALL IML2_111TLIC

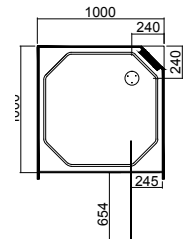

1000 x 1000 (Right Hand Moulding)

FLAT WALL IML2_111FLIC
MOULDED WALL IML2_111MRIC
TILED WALL IML2_111TLIC

PIVOT DOOR

2 SIDED - CENTRE WASTE

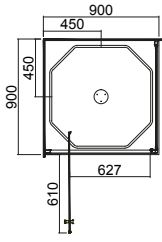

900 x 900
FLAT WALL IPAIW99SFL9X

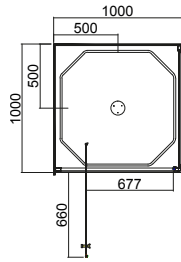

1000 x 1000
FLAT WALL IPAIWIISFLIX

2 SIDED - CORNER WASTE

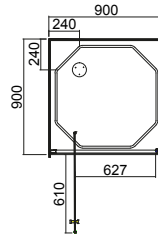

900 x 900
FLAT WALL IPAIW99SFL9C

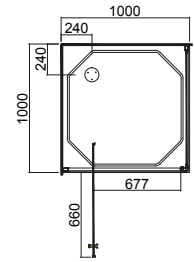

1000 x 1000
FLAT WALL IPAIWIISFLIC

3 SIDED - CENTRE WASTE

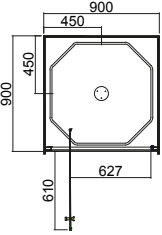

900 x 900
FLAT WALL IPAIW999FL9X

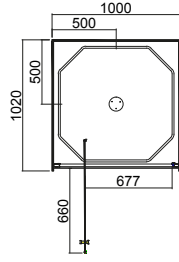

1000 x 1000
FLAT WALL IPAIWIIIIFLIX

3 SIDED - CORNER WASTE

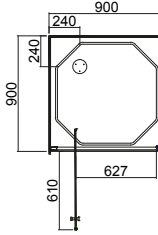

900 x 900
FLAT WALL IPAIW999FL9C

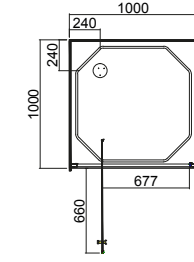

1000 x 1000
FLAT WALL IPAIWIIIIFLIC

SLIDING DOOR

2 SIDED - CENTRE WASTE

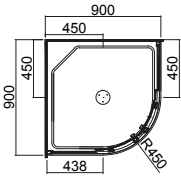

Door opening approx 495mm

900 x 900
FLAT WALL IPAIW99RFLRX

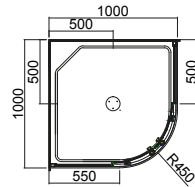

Door opening approx 495mm

1000 x 1000
FLAT WALL IPAIWIIRFLRX

2 SIDED - CORNER WASTE

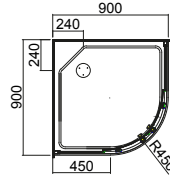

Door opening approx 495mm

900 x 900
FLAT WALL IPAIW99RFLRC

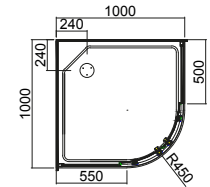

Door opening approx 495mm

1000 x 1000
FLAT WALL IPAIWIIRFLRC



Pacific 1000x1000 Square 2 Sided Flat Wall White - Corner Waste

DOORS & RETURNS

SQUARE PIVOT DOOR

- Magnetic pivot door closure
- Reversible door for left or right hand opening
- Single sided chrome bar handles
- White Joinery
- 6mm safety glass door complying to AS/NZS2208

ROUND 2 PANEL SLIDING DOORS

- Magnetic sliding door closure
- Single sided chrome bar handles
- White Joinery
- 6mm safety glass door complying to AS/NZS2208
- Quick release double roller door system for easy cleaning

WALLS

ACRYLIC

- Flat one piece Senosan® wall lining
- 1920mm high acrylic wall panel

TILED

- Suitable for tiled walls when wall receivers are installed to waterproofing prior to tiling

Optional glass shelves and footrest available (see page 66)

TRAYS

70mm SureSeal™ Shower Tray, see page 4

- Chrome Easy Clean Waste
- Showerbond adhesive is supplied for ease of installation

1950mm height: Door set on the tray

1970mm height: Wall liner on the tray

All dimensions are nominal

10 Year Warranty on door set, acrylic wall liner, SureSeal™ tray and EasyClean Waste body

12 month warranty on drip strips and vertical seals



Pacific 900x900 Round 2 Sided Flat Wall White - Centre Waste

JOINERY



White

SIZING OPTIONS See page 16 for specification details

	900x900	1000x1000
PACIFIC ROUND -2 SIDED		
Centre Waste	•	•
Corner Waste	•	•
PACIFIC SQUARE -2 SIDED		
Centre Waste	•	•
Corner Waste	•	•
PACIFIC SQUARE -3 SIDED		
Centre Waste	•	•
Corner Waste	•	•

PLATINUM

SHOWER SCREEN



Platinum 960mm Shower Screen
Pinnacle Pro 1500mm Vanity Baroque

WALK-IN SHOWER SCREENS

Clearlite Platinum Walk in Shower Screens offer easy access when space is a premium, as there is no need for doors to be opened or closed. They also create a seamless and uninterrupted view through the bathroom.

The glass-to-wall brace is adjusted during installation to support the shower screen. Pivot to fit at an angle to an adjacent wall or across to the opposite wall. At 1200mm long, the brace can be cut to a desired length to suit the space as required.

INCLUDED

- 8mm toughened safety glass panel
- Satin wall receiver
- Satin floor sill
- Wall Brace 1200mm – can be cut to length (Install optional)
- Installation kit: screws, glazing wedges, silicone, glass adjustment packer set

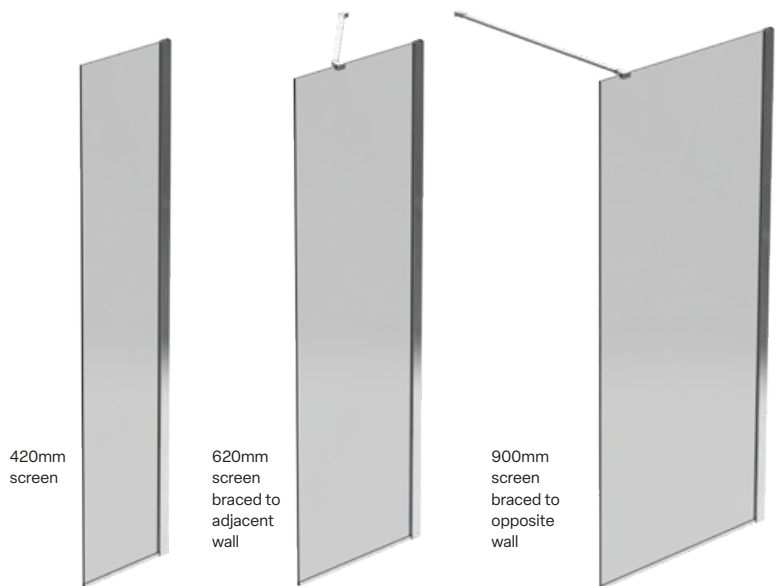

AVAILABLE IN 5 SIZES

420+/-7mm (w) x 2000mm (h)	LSSCRN0400
520+/-7mm (w) x 2000mm (h)	LSSCRN0500
620+/-7mm (w) x 2000mm (h)	LSSCRN0600
860+/-7mm (w) x 2000mm (h)	LSSCRN0900
960+/-7mm (w) x 2000mm (h)	LSSCRN1000
1200mm Brace	QASI4600

CODE	Minimum Dimension A (mm)	Maximum Dimension A (mm)
LSSCRN0400	413	428
LSSCRN0500	513	528
LSSCRN0600	613	628
LSSCRN0900	852	867
LSSCRN1000	952	967

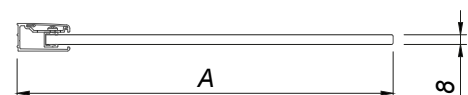

TROMBONE

ADJUSTABLE DOOR

THE ULTIMATE FOR RENOVATIONS!

The Trombone is a fully adjustable door that can be easily customised to fit the size of the door opening required. Trombone doors are a great way to update your bathroom in a rental, bach or home. There are five door sizes to choose from between 640mm to 1000mm.

The Trombone features a full length aluminium handle with integrated magnetic closure. Trombone doors are made from 6mm toughened safety glass and finished with white joinery.

10 Year Warranty on door set

12 month warranty on drip strips and vertical seals

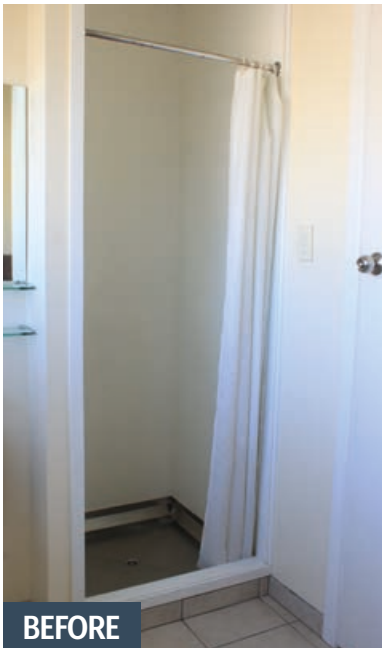

BEFORE



AFTER

Trombone 1000 Alcove Flat Wall White with Glass Shelves

CHOOSING THE CORRECT SIZE TROMBONE DOOR

- Trombone doors are available in five sizes so it is important that you select the correct one
- Each door is adjustable to ensure ease of installation and to allow for walls which are not plumb
- You will need to measure the opening width at the top and at the bottom of the opening
- Each door has adjustability which varies between 60mm and 100mm (refer to chart below)
- When measuring make sure the tape measure remains level at all times to ensure correct measurements are obtained as this will impact on the door size required
- If you have different measurements at the top and the bottom and these measurements cross over between two door sizes then order the larger door so as to avoid over extending the frame as it can compromise the stability of the door once installed.

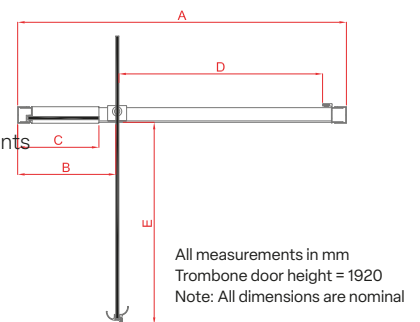

CODE	A (Minimum / Maximum)	B (Minimum / Maximum)	C	D	E
100800640	640 / 700	188 / 248	140	399	396
100800700	700 / 760	218 / 278	184	429	426
100800760	760 / 840	218 / 298	184	489	486
100800840	840 / 940	268 / 368	220	519	516
100800940	940 / 1000	328 / 388	290	559	556

INCLUDED

- 6mm toughened safety glass panels
- White joinery door set
- Installation kit: screws, drip seal, silicone

VANITIES, MIRRORS & STORAGE

A well placed mirror or considered storage solution can make a huge difference to your bathroom space. We offer an array of solutions to help transform your bathroom area into a functional yet stylish space. Our cabinets are manufactured in New Zealand from locally sourced board and assembled by an expert team to ensure a long lasting product built with the quality you expect from Clearlite Bathrooms.



VANITY TOPS

Acrylic vanity tops offer a glossy smooth finish with straight edges. A hardwearing product that is manufactured using thermoformed Lucite® acrylic reinforced with polyester resin.

Composite tops and basins have a gloss surface that achieves a clean smooth look almost free from surface imperfections. Tops are resistant to impact damage and offer good dimensional stability. Composite tops are created using a mixture of resin and mineral fillers with a hardwearing gel coat top surface.

Vitreous China (or VC) has a classic appearance with its solid glassy finish. VC products offer excellent heat, scratch, stain and wear resistance. Made from a natural material it is a cast ceramic (clay) glazed with enamel (glass). Due to the nature of its production, visible imperfections and variations in sizes are part of the overall look of VC meaning no two tops are produced the same.



MATERIAL AND CONSTRUCTION

The foundation of great design is top class materials and construction. At Clearlite Bathrooms we are proud to know that our customers enjoy world class materials in the construction of all cabinets, which are manufactured right here in New Zealand. If you visit the leading interior fashion fairs in Milan or Cologne, you will see New Zealand can manufacture to a standard that is the equal of anywhere in the world, if not better. The key materials in our vanity cabinets utilise the best in worldwide proven market-leading technology.

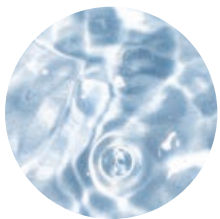

BOARD + BOND = THE MOISTURE RESISTANT TEAM

Bathrooms by their nature are exposed to moisture from splashes and steam. For all melamine and colour finishes we use New Zealand supplied Moisture Resistant Board. It is the combination of this Moisture Resistant board with PUR bonding technology that delivers the most moisture, and heat resistant cabinet possible.

PUR bonding technology was originally developed in Europe to withstand the harsh shipping conditions to the fast-growing, demanding luxury markets of the Middle East. PUR bonding is acknowledged worldwide as delivering the most heat resistant, moisture resistant, and near-seamless bond possible. Technically it chemically sets against the moisture carried via air and therefore it literally resists moisture. For this reason, it is the perfect pairing with the Moisture Resistant board.

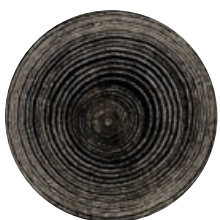

NEW ZEALAND GROWN - NEW ZEALAND MANUFACTURED - ENVIRONMENTALLY SUSTAINABLE BOARD.

New Zealand's board is highly regarded around the world for its environmental sustainability and low emission characteristics. Sourced only from New Zealand's sustainable FSC certified Radiata Pine Plantations, New Zealand board producers pioneered the drive to low-formaldehyde emissions. This quality standard is required in key export markets of Japan and USA and is delivered to our customers. This low emission board is infused with a treatment that provides the extra resistance to splashes and steam when compared to standard board.



CABINET HANDLES

All Clearlite vanities and storage towers are fitted with Standard Finish handles* specifically designed to enhance the overall visual appeal of the unit. For our Nikau range that means a Brushed Silver edge design, for the Compass a Satin Silver curved handle as standard, while all other Clearlite models are fitted with a Brushed Nickel square handle.

Customise your vanity cabinet by adding different colour handles that compliment your bathroom tapware and accessories. Upgrade finishes are available to order (per handle) in addition to the standard finish (fitted handle). See Clearlite.co.nz for more information.

*Excludes our handleless Pinnacle and Veva ranges.

NIKAU RANGE

STANDARD FINISH

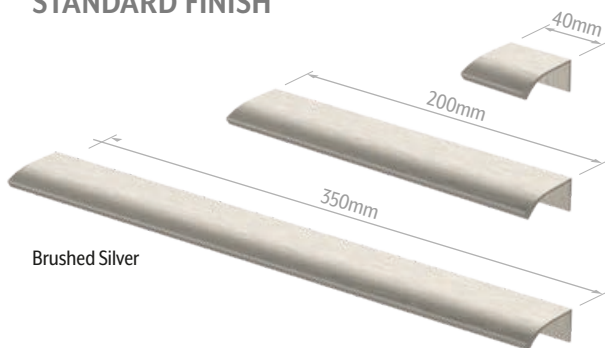

UPGRADE FINISHES



BOLERO, CASHMERE, NORFOLK, MIMAS, RAGLAN & STATESMAN RANGES

STANDARD FINISH

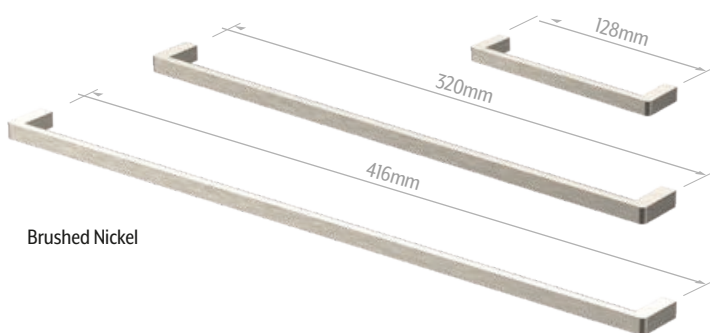

UPGRADE FINISHES



COMPASS RANGE

STANDARD FINISH



PACIFIC HANDLE

STANDARD FINISH

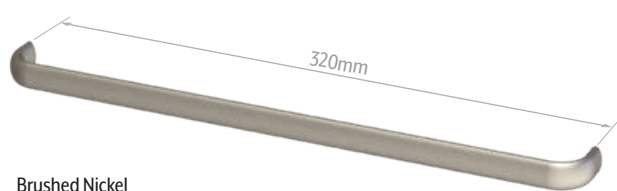

CABINET FINISHES

Clearlite cabinet finishes are extremely durable and are now available in a wide range of solid and woodgrain finishes. The melamine surface is made to resist bumps and knocks to ensure it maintain an 'as new' finish over time. A coloured layer is heat bonded to the surface of locally and sustainably sourced board then finished with colour matched PVC capped edging. The result is a hard wearing cabinet that when looked after, is designed to last for years to come.

Standard Colour Finishes A solid or woodgrain melamine cabinet is the perfect way to bring personality and texture to any bathroom.

Ultra Gloss White Achieved by utilising world leading acrylic laminate technology to produce an exceptional gloss with a deep lustre for an elegant finish.

White Melamine Clearlite white melamine cabinets offer an affordable option without comprising on quality or design. Available in all Clearlite ranges excluding Nikau.



Anthracite



Indian Ink

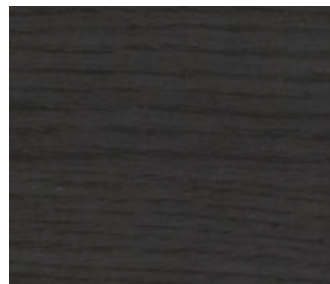

Charred Oak

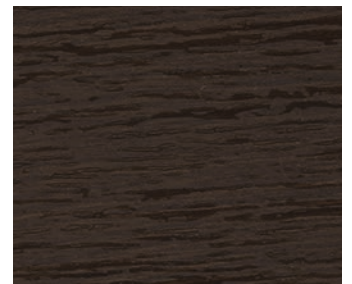

Borders Oak



Green Slate



Triple Duck Egg



Hickory Walnut



Blackened Elm

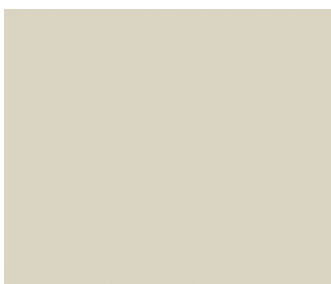

Tusk/Quarter Napa



Friar Grey



Baroque



Rural Oak

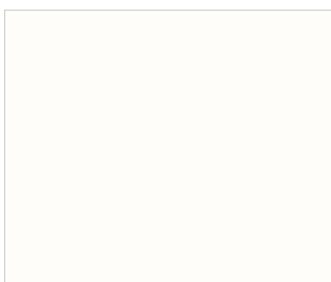

Ultra Gloss White
& White Melamine

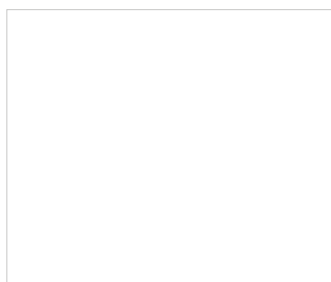

Perfect White



Nordic Ash



Ranfurly Oak

VC BASINS

Clearlite Vitreous China basins are designed to work in with your vision of your bathroom space, allowing a greater freedom of placement on most vanity sizes.

VC BASIN 355 ROUND

355 x 120mm in Vitreous China

Available in 4 colours

- MATT WHITE** VBVC355RMWH
- MATT LIGHT GREY** VBVC355RMLG
- MATT DARK GREY** VBVC355RMDG
- MATT BLACK** VBVC355RMBL

Chrome and black waste kits sold separately.

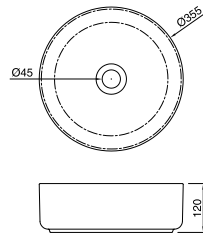

VC BASIN 360 SQUARE

360 x 360 x 110mm in Vitreous China

Available in 3 colours

RUNOUT - LIMITED STOCK AVAILABLE

- MATT WHITE** VBVC360SMWH
- MATT DARK GREY** VBVC360SMDG
- MATT BLACK** VBVC360SMBL

Chrome and black waste kits sold separately.

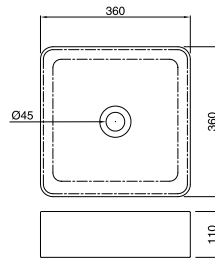

BLUFF VC BASIN

500 x 430 x 130mm

Centre tap hole

Can be positioned on a vanity bench top or wall hung for easy access

- POLISHED WHITE** VBVC5042GWH

Chrome and black waste kits and bottle traps

sold separately.

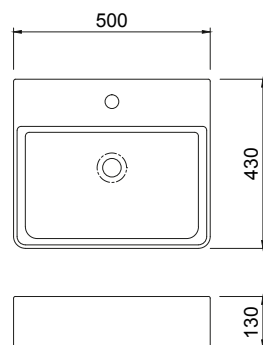



Cashmere Pro 750 Single Drawer Charred Oak with Black VC Basin 355 Round

Wall hung design with soft closing drawers

White Solid Surface bench top is non-porous and stain resistant with a soft matt finish

Add a Basin to complete the look (see page 26)

Brushed Nickel handles are standard with Black & Gunmetal upgrade finishes available (see page 24)

See pages 56 & 57 for matching storage towers and mirror cabinets

Cabinets made in New Zealand

WHEN ORDERING:

Complete your chosen product code above by specifying one of the below cabinet finishes in the blank space at the end of the code _

M for White Melamine; **G** for Ultra Gloss White; **C** for Colour

WALL HUNG

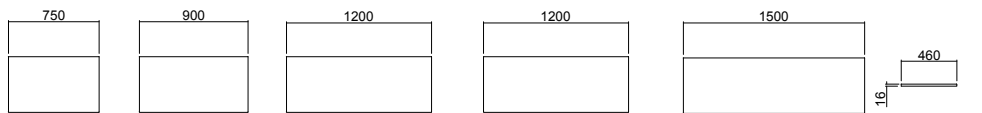

WALL OPEN

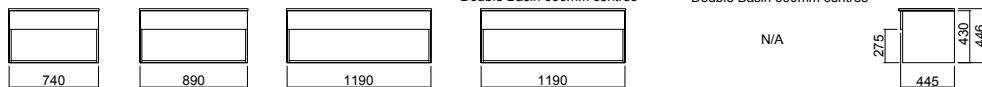

DRAWER OPEN

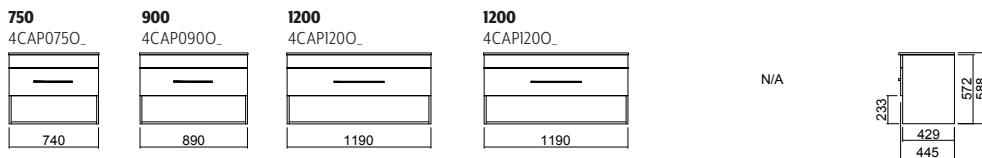

SINGLE DRAWER

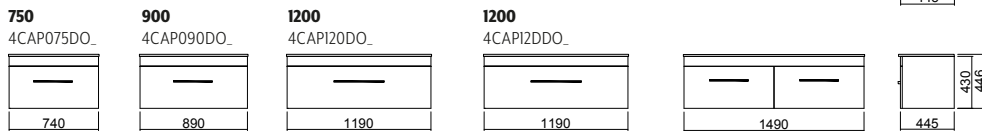

DOUBLE DRAWER

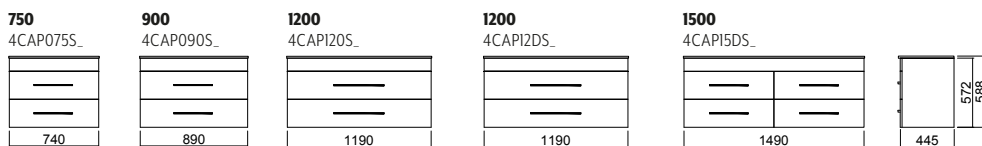

750 4CAP075D_WH 900 4CAP090D_WH 1200 4CAPI20D_WH 1200 4CAPI2DD_WH 1500 4CAPI5DD_WH

Anthracite	Friar Grey	Green Slate	Triple Duck Egg	Indian Ink	Tusk/Quarter Napa	Perfect White	Ultra Gloss White & White Melamine
Charred Oak	Blackened Elm	Borders Oak	Hickory Walnut	Baroque	Rural Oak	Ranfurly Oak	Nordic Ash

Pro Series models include a vanity cabinet & solid surface bench top only. Solid surface bench tops are supplied undrilled, to provide maximum versatility of basin configurations (sold separately). Drawer capacity rated to 9kg maximum load per drawer. Refer to clearlite.co.nz for full specifications.

PINNACLE PRO SERIES

SOLID SURFACE TOP



Pinnacle Pro 900 Drawer Open Blackened Elm with Light Grey VC Basin 355 Round

Wall hung design with featured open shelf

Negative detail soft close drawers

White Solid Surface bench top is non-porous and stain resistant with a soft matt finish

Add a Basin to complete the look (see page 26)

See pages 56 & 57 for matching storage towers and mirror cabinets

Cabinets made in New Zealand

WHEN ORDERING:

Complete your chosen product code above by specifying one of the below cabinet finishes in the blank space at the end of the code .

M for White Melamine; **G** for Ultra Gloss White; **C** for Colour

WALL HUNG

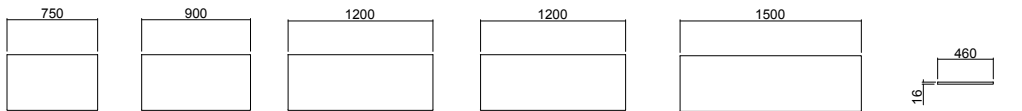

DRAWER OPEN

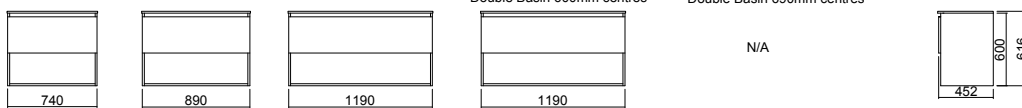

750
5PNP075DO_

900
5PNP090DO

1200
5PNP120DO_

1200
5PNP12DDO_

N/A

SINGLE DRAWER

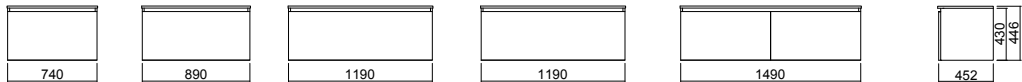

750
5PNP075S_

900
5PNP090S

1200
5PNP120S_

1200
5PNP12DDS_

1500
5PNP15DDS_

DOUBLE DRAWER

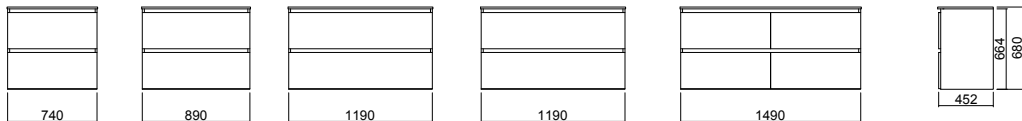

750
5PNP075D_WH

900
5PNP090D_WH

1200
5PNP120D_WH

1200
5PNP12DD_WH

1500
5PNP15DD_WH

Anthracite	Friar Grey	Green Slate	Triple Duck Egg	Indian Ink	Tusk/Quarter Napa	Perfect White	Ultra Gloss White & White Melamine
Charred Oak	Blackened Elm	Borders Oak	Hickory Walnut	Baroque	Rural Oak	Ranfurlly Oak	Nordic Ash



Nikau Pro 1500 Double Drawer Wall Anthracite and Ultra Gloss White with Dark Grey VC Basin 360 Square

Wall hung design with soft close drawers

White Solid Surface bench top is non-porous and stain resistant with a soft matt finish

Add a VC Basin to complete the look (sold separately)

Available in centre, left, right and double basin configurations

Brushed Silver handles are standard with Antique Brass, Antique Bronze, Brushed Black & Brushed Gunmetal upgrade finishes available (see page 24)

Single colour cabinet or two tone Nikau design with Ultra Gloss White front panels

Available in all standard cabinet colours except White Melamine (see page 25)

See pages 56 & 57 for matching storage towers and mirror cabinets

Cabinets made in New Zealand

WHEN ORDERING:

Complete your chosen product code above by specifying one of the below cabinet finishes in the blank space at the end of the code _

Use **X** for Ultra Gloss White/Colour(Nikau only); **G** for Ultra Gloss White; **C** for Colour

WALL HUNG

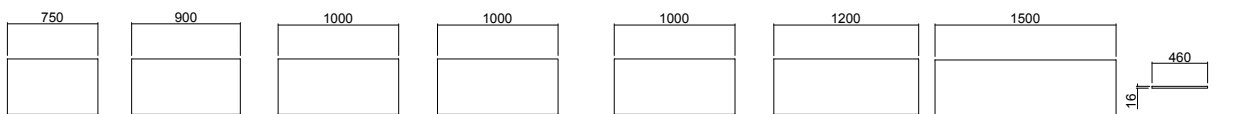

DRAWER OPEN

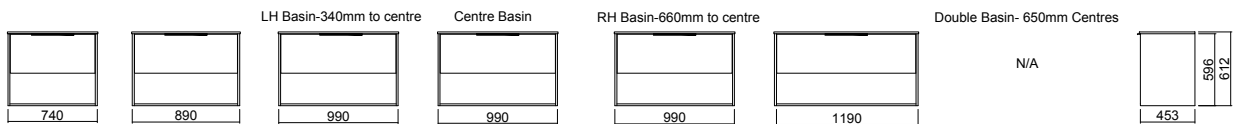

SINGLE DRAWER



DOUBLE DRAWER

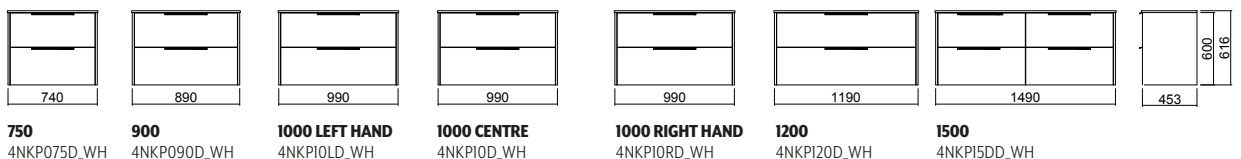

Anthracite	Friar Grey	Green Slate	Triple Duck Egg	Indian Ink	Tusk/Quarter Napa	Perfect White	Ultra Gloss White
Charred Oak	Blackened Elm	Borders Oak	Hickory Walnut	Baroque	Rural Oak	Ranfurly Oak	Nordic Ash

Pro Series models include a vanity cabinet & solid surface bench top only. Solid surface bench tops are supplied undrilled, to provide maximum versatility of basin configurations (sold separately). Drawer capacity rated to 9kg maximum load per drawer. Refer to clearlite.co.nz for full specifications.

WHEN ORDERING: Complete your chosen product code above by specifying one of the below cabinet finishes in the blank space at the end of the code .
Use **M** for White Melamine; **G** for Ultra Gloss White; **C** for Colour

CLASSIC - FLOORSTANDING

DOORS AND DRAWERS

N/A

DOORS ONLY

WALL HUNG

DOORS AND DRAWERS

N/A

DOORS ONLY

Internal Basin Depth 125 mm
Not drilled for tapware

600 5STM060CD_

750 5STM075CD_

900 5STM090CD_

1200 5STM120CD_

600 5STM060CD_WH

750 5STM075CD_WH

900 5STM090CD_WH

1200 5STM120CD_WH

DRAWERS ONLY - FLOORSTANDING

DOUBLE DRAWER

WALL HUNG SINGLE DRAWER

DOUBLE DRAWER

Internal Basin Depth 125 mm
Not drilled for tapware

600 5STM060D_

750 5STM075D_

900 5STM090D_

1200 5STM120D_

600 5STM060S_

750 5STM075S_

900 5STM090S_

1200 5STM120S_

600 5STM060D_WH

750 5STM075D_WH

900 5STM090D_WH

1200 5STM120D_WH

WALL HUNG	600	750	900	1200
Classic - Doors & Drawers		.	.	.
Doors Only
Single Drawer
Double Drawer
FLOORSTANDING	600	750	900	1200
Classic - Doors & Drawers		.	.	.
Doors Only
Double Drawer

See page 22 for additional vanity information



Statesman 750 Double Drawer Wall Ranfurly Oak

- Contemporary Acrylic top with upstand and no overflow
- Classic doors and drawers, door or drawer only cabinet styles
- Floorstanding and wall hung options
- Soft closing doors and drawers
- Tap holes to be drilled at installation to suit tapware
- Brushed Nickel handles are standard with Black & Gunmetal upgrade finishes available (see page 24)
- See pages 54 & 55 matching towers and mirrors

Cabinets made in New Zealand



Statesman 900 Top



Statesman 1200 Classic Floor Ultra Gloss White



Statesman 900 Single Drawer Wall Hung Charred Oak

Anthracite	Friar Grey	Green Slate	Triple Duck Egg	Indian Ink	Tusk/Quarter Napa	Perfect White	Ultra Gloss White & White Melamine
Charred Oak	Blackened Elm	Borders Oak	Hickory Walnut	Baroque	Rural Oak	Ranfurly Oak	Nordic Ash

WHEN ORDERING: Complete your chosen product code above by specifying one of the below cabinet finishes in the blank space at the end of the code.
Use **M** for White Melamine; **G** for Ultra Gloss White; **C** for Colour

CLASSIC - FLOORSTANDING

DOORS AND DRAWERS

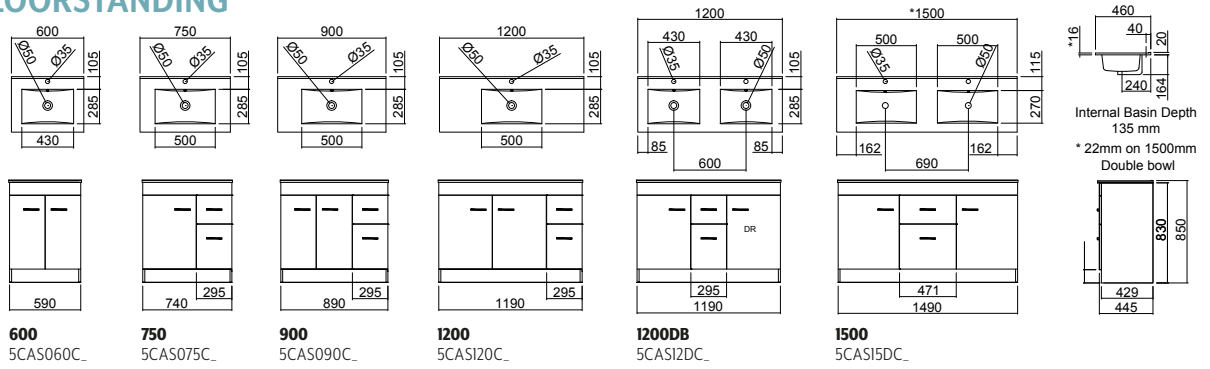

WALL HUNG OPEN

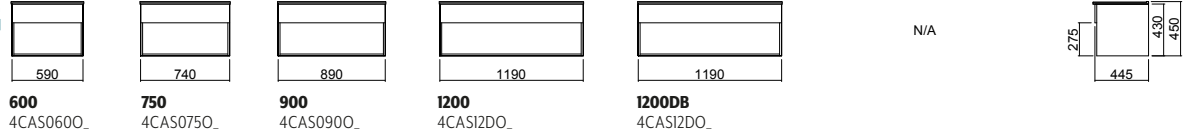

DOORS AND DRAWERS

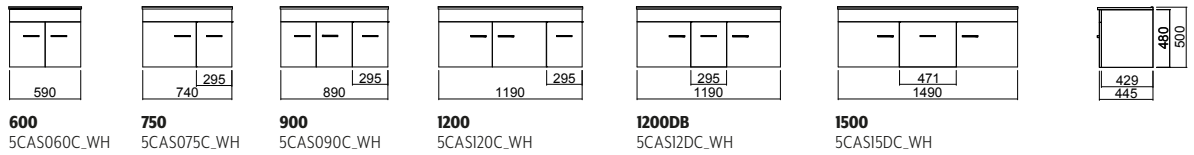

DRAWERS ONLY - FLOORSTANDING

DOUBLE DRAWER

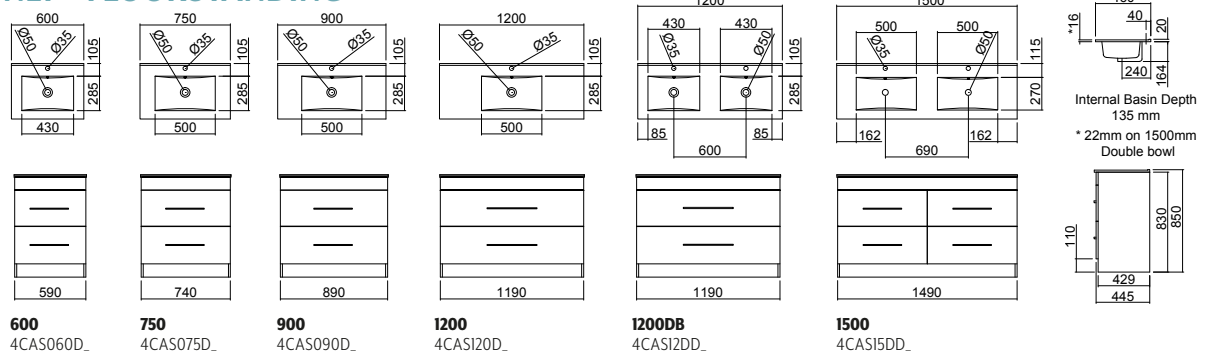

WALL HUNG SINGLE DRAWER

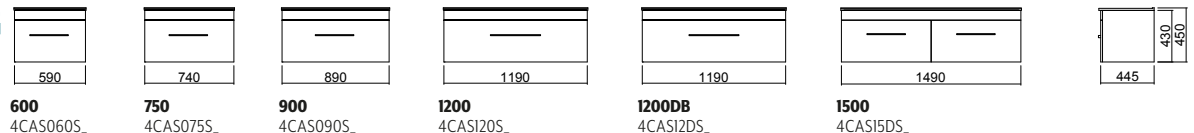

DRAWER OPEN

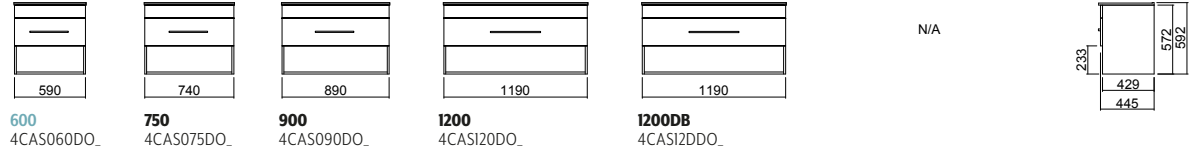

DOUBLE DRAWER

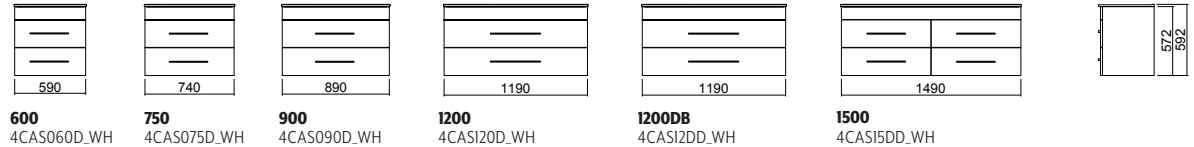

WALL HUNG	600	750	900	1200	1200DB	1500DB
Classic - Doors & Drawers	• [^]	•	•	•	•	•
Open	•	•	•	•	•	•
Drawer Open	•	•	•	•	•	•
Single Drawer	•	•	•	•	•	•
Double Drawer	•	•	•	•	•	•
FLOORSTANDING						
Classic - Doors & Drawers	• [^]	•	•	•	•	•
Double Drawer	•	•	•	•	•	•

See page 22 for additional vanity information

[^] Doors Only

CASHMERE

VITREOUS CHINA TOP



Cashmere 1200 Single Drawer Wall Hung Ranfurly Oak

Vitreous China slim profile top with integrated overflow
 1500mm models are supplied with a Composite Top
 Single tap hole only

Classic doors and drawers, single drawer, drawer open and double drawer styles
 Wall Hung and Floorstanding options

Soft closing doors and drawers

Brushed Nickel handles are standard with Black & Gunmetal upgrade finishes available (see page 24)

See pages 54 & 55 matching towers and mirrors

Cabinets made in New Zealand



Cashmere 900 Top



Cashmere 750 Single Drawer Wall Hung Hickory Walnut



Cashmere 900 Classic Wall Hung Baroque

Anthracite	Friar Grey	Green Slate	Triple Duck Egg	Indian Ink	Tusk/Quarter Napa	Perfect White	Ultra Gloss White & White Melamine
Charred Oak	Blackened Elm	Borders Oak	Hickory Walnut	Baroque	Rural Oak	Ranfurly Oak	Nordic Ash

WHEN ORDERING: Complete your chosen product code above by specifying one of the below cabinet finishes in the blank space at the end of the code _
Use **M** for White Melamine; **G** for Ultra Gloss White; **C** for Colour

CLASSIC - FLOORSTANDING

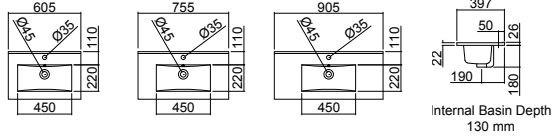

DOORS AND DRAWERS



600
5CSL060C_

750
5CSL075C_

900
5CSL090C_

WALL HUNG

OPEN

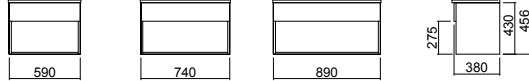

600
4CSL060O_

750
4CSL075O_

900
4CSL090O_

DOORS AND DRAWERS

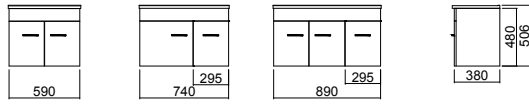

600
5CSL060C_WH

750
5CSL075C_WH

900
5CSL090C_WH

DRAWERS ONLY - FLOORSTANDING

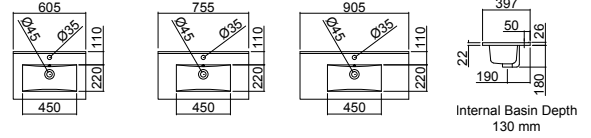

DOUBLE DRAWER

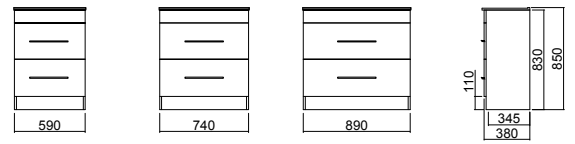

600
4CSL060D_

750
4CSL075D_

900
4CSL090D_

WALL HUNG

SINGLE DRAWER

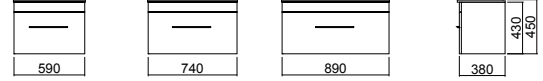

600
4CSL060S_

750
4CSL075S_

900
4CSL090S_

DRAWER OPEN

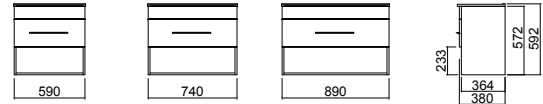

600
4CSL060DO_

750
4CSL075DO_

900
4CSL090DO_

DOUBLE DRAWER

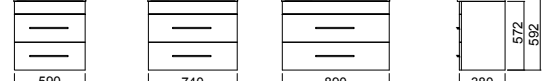

600
4CSL060D_WH

750
4CSL075D_WH

900
4CSL090D_WH

WALL HUNG	600	750	900
Classic - Doors & Drawers	• [^]	•	•
Open	•	•	•
Drawer Open	•	•	•
Single Drawer	•	•	•
Double Drawer	•	•	•
FLOORSTANDING			
Classic - Doors & Drawers	• [^]	•	•
Double Drawer	•	•	•

See page 22 for additional vanity information

[^] Doors Only



Cashmere Slim 900 Double Drawer Wall Hung Nordic Ash

- Composite top with integrated overflow
- Single tap hole only
- Classic doors and drawers cabinet styles
- Contemporary single & double drawer and drawer open cabinet style options
- Floorstanding and Wall Hung options
- Soft closing doors and drawers
- Brushed Nickel handles are standard with Black & Gunmetal upgrade finishes available (see page 24)
- See pages 54 & 55 matching towers and mirrors

Cabinets made in New Zealand



Cashmere Slim 900 Top



Cashmere Slim 600 Classic Wall Hung Charred Oak



Cashmere Slim 750 Wall Hung Nordic Ash



Cashmere Slim 750 Double Drawer Floor Blackened Elm

Anthracite	Friar Grey	Green Slate	Triple Duck Egg	Indian Ink	Tusk/Quarter Napa	Perfect White	Ultra Gloss White & White Melamine
Charred Oak	Blackened Elm	Borders Oak	Hickory Walnut	Baroque	Rural Oak	Ranfurly Oak	Nordic Ash

WHEN ORDERING: Complete your chosen product code above by specifying one of the below cabinet finishes in the blank space at the end of the code _
M for White Melamine; **G** for Ultra Gloss White; **C** for Colour

FLOORSTANDING

DOUBLE DRAWER

590	740	890	1190	1190	1490	452
600 5PIN060D_	750 5PIN075D_	900 5PIN090D_	1200 5PIN120D_	1200DB 5PIN12DD_	1500 5PIN15DD_	

WALL HUNG

SINGLE DRAWER

590	740	890	1190	1190	1490	452
600 5PIN060S_	750 5PIN075S_	900 5PIN090S_	1200 5PIN120S_	1200DB 5PIN12DS_	1500 5PIN15DS_	

DRAWER OPEN

					N/A	
590	740	890	1190	1190		452
600 5PIN060DO_	750 5PIN075DO_	900 5PIN090DO_	1200 5PIN120DO_	1200DB 5PIN12DDO_		

DOUBLE DRAWER

590	740	890	1190	1190	1490	452
600 5PIN060D_WH	750 5PIN075D_WH	900 5PIN090D_WH	1200 5PIN120D_WH	1200DB 5PIN12DD_WH	1500 5PIN15DD_WH	

WALL HUNG	600	750	900	1200	1200DB	1500DB
Drawer Open	•	•	•	•	•	
Single Drawer	•	•	•	•	•	•
Double Drawer	•	•	•	•	•	•
FLOORSTANDING						
Double Drawer	•	•	•	•	•	•

See page 22 for additional vanity information

PINNACLE

VITREOUS CHINA TOP



Pinnacle 900 Single Drawer Wall Hung Vanity White Melamine and Varo Back to Wall Bath

- Vitreous china top with integrated overflow
 - 1500mm models are supplied with a Composite Top
 - Single tap hole only
 - Contemporary drawer only cabinet style
 - Floorstanding and Wall Hung options
 - Negative detail soft close drawers
 - See pages 54 & 55 matching towers and mirrors
- Cabinets made in New Zealand**



Pinnacle 900 Top



Pinnacle 1200 Double Bowl Single Drawers Wall Blackened Elm



Pinnacle 750 Double Drawer Floor Hickory Walnut

Anthracite	Friar Grey	Green Slate	Triple Duck Egg	Indian Ink	Tusk/Quarter Napa	Perfect White	Ultra Gloss White & White Melamine
Charred Oak	Blackened Elm	Borders Oak	Hickory Walnut	Baroque	Rural Oak	Ranfurly Oak	Nordic Ash

WHEN ORDERING:

Complete your chosen product code above by specifying one of the below cabinet finishes in the blank space at the end of the code _
 Use **M** for White Melamine; **G** for Ultra Gloss White; **C** for Colour

FLOORSTANDING

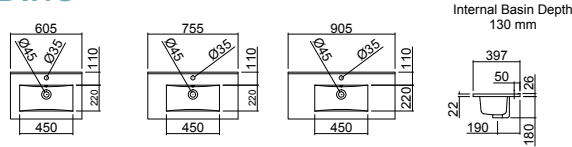

DOUBLE DRAWER

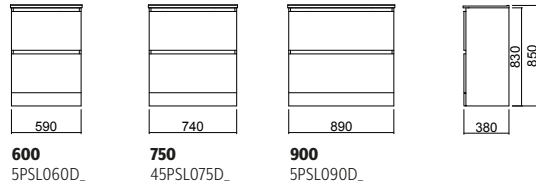

WALL HUNG

SINGLE DRAWER

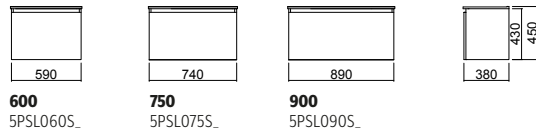

DRAWER OPEN

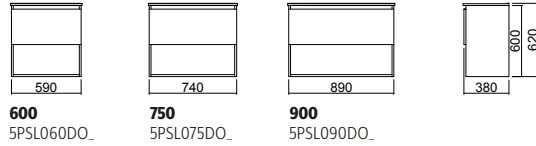

DOUBLE DRAWER



WALL HUNG	600	750	900
Drawer Open	•	•	•
Single Drawer	•	•	•
Double Drawer	•	•	•
FLOORSTANDING			
Double Drawer	•	•	•

See page 22 for additional vanity information

PINNACLE SLIM
COMPOSITE TOP



Pinnacle Slim 750 Double Drawer Ultra Gloss White

- Composite top with integrated overflow
- Single tap hole only
- Narrow design for smaller spaces
- Contemporary drawer only cabinet style
- Floorstanding and Wall Hung options
- Negative detail soft close drawers
- See pages 54 & 55 matching towers and mirrors

Cabinets made in New Zealand



Cashmere Slim 900 Top



Pinnacle Slim 900 Drawer Open Wall Hung Baroque



Pinnacle Slim 750 Double Drawer Floor Blackened Elm

Anthracite	Friar Grey	Green Slate	Triple Duck Egg	Indian Ink	Tusk/Quarter Napa	Perfect White	Ultra Gloss White & White Melamine
Charred Oak	Blackened Elm	Borders Oak	Hickory Walnut	Baroque	Rural Oak	Ranfurly Oak	Nordic Ash

WHEN ORDERING: Complete your chosen product code above by specifying one of the below cabinet finishes in the blank space at the end of the code .
Use **M** for White Melamine; **G** for Ultra Gloss White; **C** for Colour

FLOORSTANDING

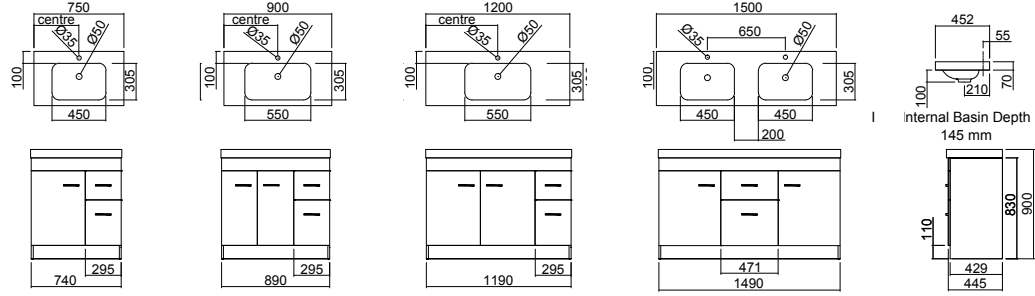

DOORS AND DRAWERS

WALL HUNG DOORS AND DRAWERS

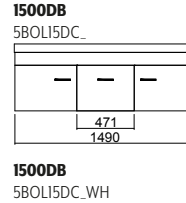
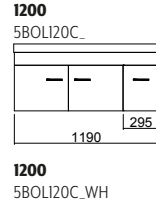
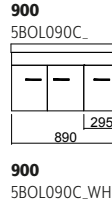
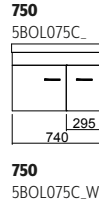

DRAWERS ONLY - FLOORSTANDING

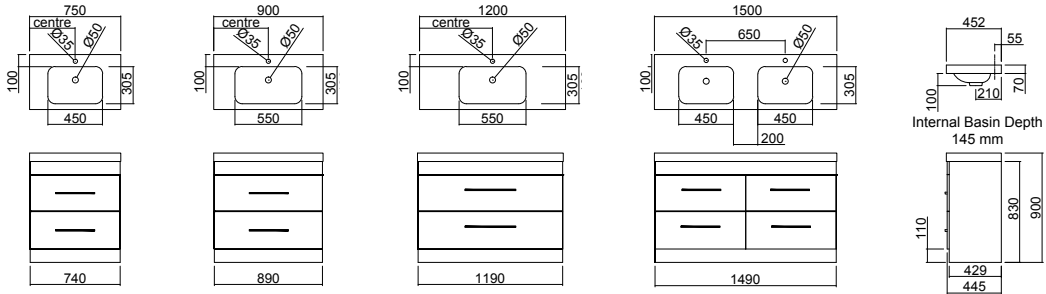

DOUBLE DRAWER

WALL HUNG OPEN

SINGLE DRAWER

DRAWER OPEN

DOUBLE DRAWER

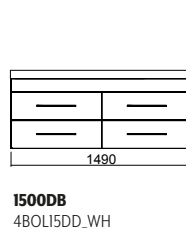
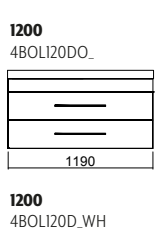
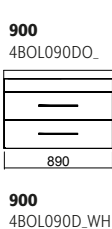
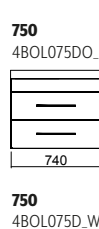
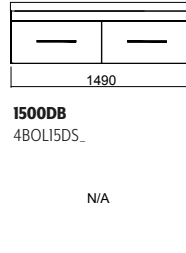
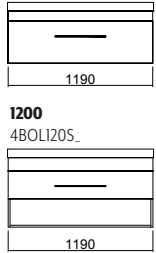
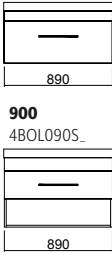
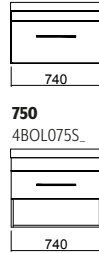
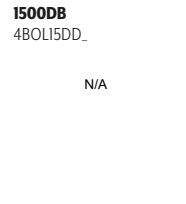
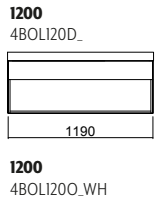
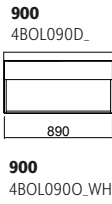
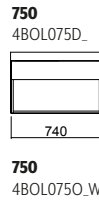

WALL HUNG	750	900	1200	1500DB
Classic - Doors & Drawers	•	•	•	•
Open	•	•	•	
Drawer Open	•	•	•	
Single Drawer	•	•	•	•
Double Drawer	•	•	•	•
FLOORSTANDING				
Classic - Doors & Drawers	•	•	•	•
Double Drawer	•	•	•	•

See page 22 for additional vanity information

BOLERO

COMPOSITE TOP



Bolero 900 Single Drawer Open Vanity Ultra Gloss White and Mahia 900x750 Mirror Cabinet

Composite top with soft basin corners and thick external edges

Single tap hole only

Classic doors and drawers, single drawer, drawer open and double drawer styles

Wall Hung and Floorstanding options

Soft closing doors and drawers

Brushed Nickel handles are standard with Black & Gunmetal upgrade finishes available (see page 24)

See pages 54 & 55 matching towers and mirrors

Cabinets made in New Zealand



Bolero 900 Top



Bolero 750 Drawer Open Wall Hung Hickory Walnut



Bolero 900 Classic Wall Hung Baroque

Anthracite	Friar Grey	Green Slate	Triple Duck Egg	Indian Ink	Tusk/Quarter Napa	Perfect White	Ultra Gloss White & White Melamine
Charred Oak	Blackened Elm	Borders Oak	Hickory Walnut	Baroque	Rural Oak	Ranfurly Oak	Nordic Ash

See pages 24 & 25 for handle info and larger colour swatches

WHEN ORDERING: Complete your chosen product code above by specifying one of the below cabinet finishes in the blank space at the end of the code .
M for White Melamine; **G** for Ultra Gloss White; **C** for Colour

CLASSIC - FLOORSTANDING

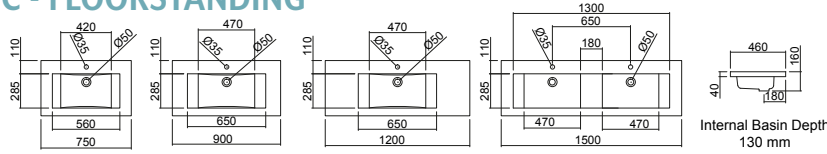

DOORS AND DRAWERS

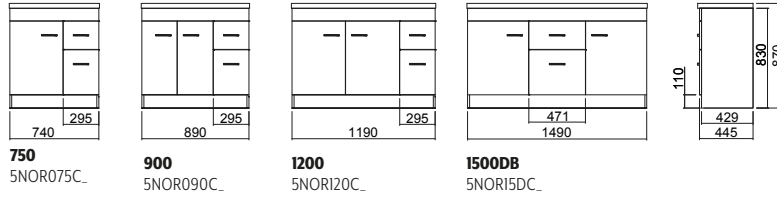

WALL HUNG

DOORS AND DRAWERS

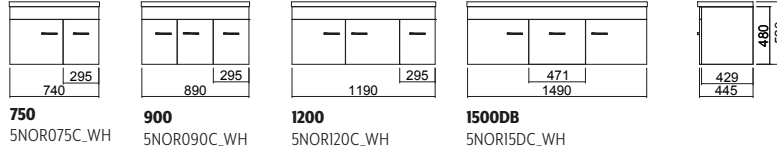

DRAWERS ONLY - FLOORSTANDING

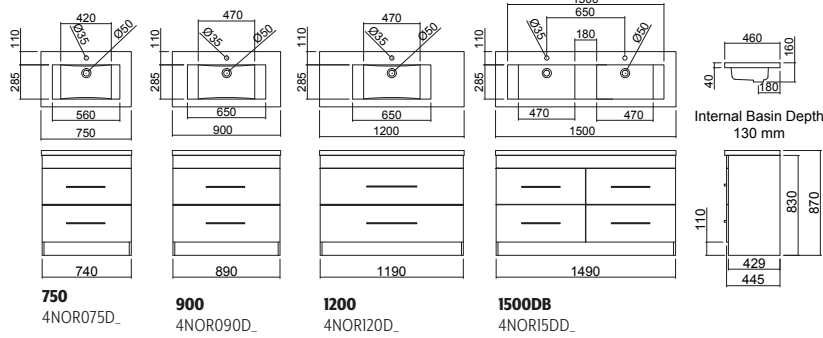

DOUBLE DRAWER

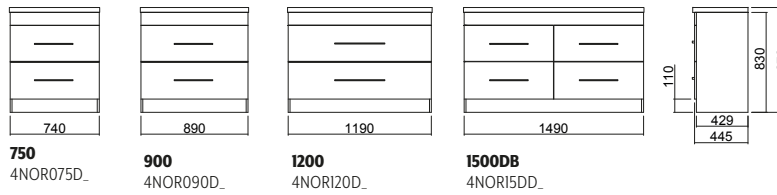

WALL HUNG

SINGLE DRAWER

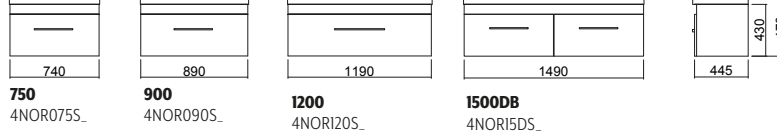

DRAWER OPEN

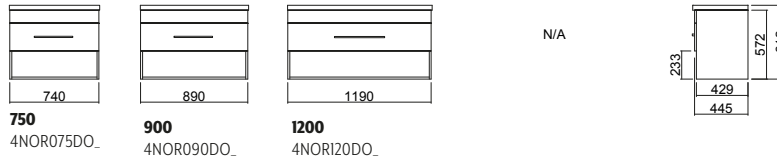

DOUBLE DRAWER

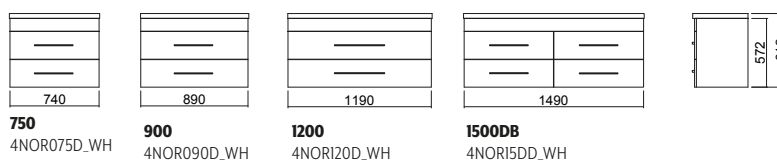

WALL HUNG	750	900	1200	1500DB
Classic - Doors & Drawers	•	•	•	•
Drawer Open	•	•	•	
Single Drawer	•	•	•	•
Double Drawer	•	•	•	•
FLOORSTANDING				
Classic - Doors & Drawers	•	•	•	•
Double Drawer	•	•	•	•

See page 22 for additional vanity information

NORFOLK

COMPOSITE TOP



Norfolk 900 Classic Floor Baroque with Black Handle Option

- Composite top with squared edges and a sweeping basin shape
- Single tap hole only
- Classic doors and drawers, single drawer, open and double drawer styles
- Floorstanding and Wall Hung options
- Soft closing doors and drawers
- Brushed Nickel handles are standard with Black & Gunmetal upgrade finishes available (see page 24)
- See pages 54 & 55 matching towers and mirrors

Cabinets made in New Zealand



Norfolk 900 Top



Norfolk 1200 Single Drawer Wall Hung Charred Oak



Norfolk 750 Double Drawer Wall Hung Blackened Elm

Anthracite	Friar Grey	Green Slate	Triple Duck Egg	Indian Ink	Tusk/Quarter Napa	Perfect White	Ultra Gloss White & White Melamine
Charred Oak	Blackened Elm	Borders Oak	Hickory Walnut	Baroque	Rural Oak	Ranfurly Oak	Nordic Ash

See pages 24 & 25 for handle info and larger colour swatches

WHEN ORDERING: Complete your chosen product code above by specifying one of the below cabinet finishes in the blank space at the end of the code .
M for White Melamine; **G** for Ultra Gloss White; **C** for Colour

CLASSIC - FLOORSTANDING

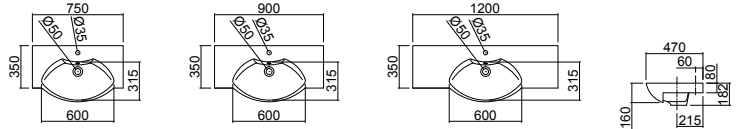

DOORS AND DRAWERS

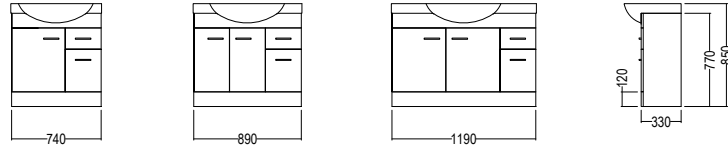

750
5RAG075C_

900
5RAG090C_

1200
5RAG120C_

WALL HUNG

DOORS AND DRAWERS

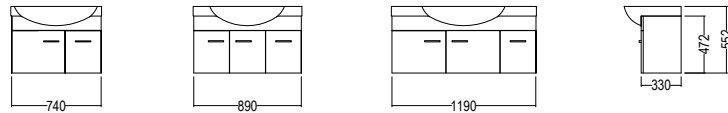

750
5RAG075C_WH

900
5RAG090C_WH

1200
5RAG120C_WH

DRAWERS ONLY - FLOORSTANDING

DOUBLE DRAWER

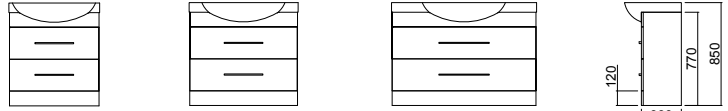

750
4RAG075D_

900
4RAG090D_

1200
4RAG120D_

WALL HUNG

SINGLE DRAWER

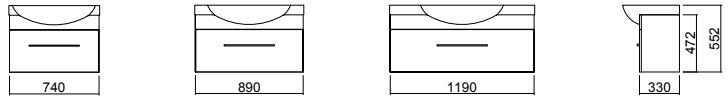

750
4RAG075S_

900
4RAG090S_

1200
4RAG120S_

DOUBLE DRAWER

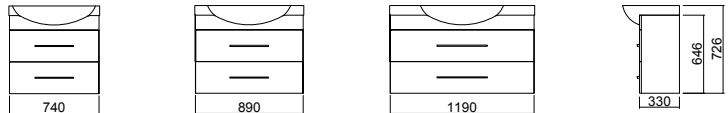

750
4RAG075D_WH

900
4RAG090D_WH

1200
4RAG120D_WH

WALL HUNG	750	900	1200
Classic - Doors & Drawers	•	•	•
Single Drawer	•	•	•
Double Drawer	•	•	•
FLOORSTANDING			
Classic - Doors & Drawers	•	•	•
Double Drawer	•	•	•

See page 22 for additional vanity information

^ Doors Only

RAGLAN

COMPOSITE TOP



Raglan 1200 Double Drawer Floor Baroque

- Semi recessed composite top with integrated overflow
- Generous basin size
- Single tap hole only
- Classic doors and drawers cabinet style options
- Contemporary drawer only cabinet style options
- Floorstanding and Wall Hung options
- Soft closing doors and drawers
- Brushed Nickel handles are standard with Black & Gunmetal upgrade finishes available (see page 24)
- See pages 54 & 55 matching towers and mirrors

Cabinets made in New Zealand



Raglan 900 Top



Raglan 900 Classic Wall Ultra Gloss White



Raglan 1200 Classic Floor Hickory Walnut

Anthracite	Friar Grey	Green Slate	Triple Duck Egg	Indian Ink	Tusk/Quarter Napa	Perfect White	Ultra Gloss White & White Melamine
Charred Oak	Blackened Elm	Borders Oak	Hickory Walnut	Baroque	Rural Oak	Ranfurly Oak	Nordic Ash

See pages 24 & 25 for handle info and larger colour swatches

WHEN ORDERING:

Complete your chosen product code above by specifying one of the below cabinet finishes in the blank space at the end of the code _
 Use **X** for Ultra Gloss White/Colour (Nikau only); **G** for Ultra Gloss White; **C** for Colour

CLASSIC - FLOORSTANDING

DOORS AND DRAWERS

Top views show widths of 750, 900, 1000, 1000, 1000, 1200, and 1500mm. Internal basin depth is 120mm. Tap platform depth is 100mm.

Side views show widths of 740, 890, 990, 990, 990, 1190, and 1490mm. Internal basin depth is 120mm. Tap platform depth is 100mm.

Product codes: 750 4NIK075C_, 900 4NIK090C_, 1000 4NIK100C_, 1000 4NIK100C_, 1000 4NIK100C_, 1200 4NIK120C_, 1500DB 4NIK15DC_

WALL HUNG

DOORS AND DRAWERS

Top views show widths of 750, 900, 1000, 1000, 1000, 1200, and 1500DB.

Side views show widths of 740, 890, 990, 990, 990, 1190, and 1490mm. Internal basin depth is 120mm. Tap platform depth is 100mm.

Product codes: 750 4NIK075C_WH, 900 4NIK090C_WH, 1000 4NIK100C_WH, 1000 4NIK100C_WH, 1000 4NIK100C_WH, 1200 4NIK120C_WH, 1500DB 4NIK15DC_WH

DRAWERS ONLY - FLOORSTANDING

DOUBLE DRAWER

Top views show widths of 750, 900, 1000, 1000, 1000, 1200, and 1500mm. Internal basin depth is 120mm. Tap platform depth is 100mm.

Side views show widths of 740, 890, 990, 990, 990, 1190, and 1490mm. Internal basin depth is 120mm. Tap platform depth is 100mm.

Product codes: 750 4NIK075D_, 900 4NIK090D_, 1000 4NIK100D_, 1000 4NIK100D_, 1000 4NIK100D_, 1200 4NIK120D_, 1500DB 4NIK15DD_

WALL HUNG

SINGLE DRAWER

Top views show widths of 750, 900, 1000, 1000, 1000, 1200, and 1500DB.

Side views show widths of 740, 890, 990, 990, 990, 1190, and 1490mm. Internal basin depth is 120mm. Tap platform depth is 100mm.

Product codes: 750 4NIK075S_, 900 4NIK090S_, 1000 4NIK100S_, 1000 4NIK100S_, 1000 4NIK100S_, 1200 4NIK120S_, 1500DB 4NIK15DS_

DRAWER OPEN

Top views show widths of 750, 900, 1000, 1000, 1000, 1200, and 1500DB.

Side views show widths of 740, 890, 990, 990, 990, 1190, and 1490mm. Internal basin depth is 120mm. Tap platform depth is 100mm.

Product codes: 750 4NIK075DO_, 900 4NIK090DO_, 1000 4NIK100DO_, 1000 4NIK100DO_, 1000 4NIK100DO_, 1200 4NIK120DO_, 1500DB 4NIK15DD_

DOUBLE DRAWER

Top views show widths of 750, 900, 1000, 1000, 1000, 1200, and 1500DB.

Side views show widths of 740, 890, 990, 990, 990, 1190, and 1490mm. Internal basin depth is 120mm. Tap platform depth is 100mm.

Product codes: 750 4NIK075D_WH, 900 4NIK090D_WH, 1000 4NIK100D_WH, 1000 4NIK100D_WH, 1000 4NIK100D_WH, 1200 4NIK120D_WH, 1500DB 4NIK15DD_WH

WALL HUNG	750	900	1000C	1000L	1000R	1200	1500DB
Classic - Doors & Drawers
Drawer Open
Single Drawer
Double Drawer
FLOORSTANDING							
Classic - Doors & Drawers
Double Drawer

See page 22 for additional vanity information



Nikau 1200 Double Drawer Wall Hung Ultra Gloss White and Baroque with optional Black Handles
 Nikau 350 Tower Ultra Gloss White and Baroque, 1200 Mahia Mirror Cabinet in Baroque

Composite top without an overflow

All models are available with a centre bowl

1000mm models can have a left or right hand bowl and left or right hand drawer for doors and drawers models

Floorstanding and Wall hung options

Features exposed end panels and discreet handles

Brushed Silver handles are standard with Antique Brass, Antique Bronze, Brushed Black & Brushed Gunmetal upgrade finishes available (see page 24)

Available in all colours except White Melamine

Single colour cabinet or two tone Nikau design with Ultra Gloss White front panels

See pages 54 & 55 matching towers and mirrors

Cabinets made in New Zealand



Nikau 900 Top



Nikau 1500 Classic Double Drawer Double Bowl Wall Hung White and Rural Oak



Nikau 1000 Classic Floor Baroque Right Hand Basin

Anthracite	Friar Grey	Green Slate	Triple Duck Egg	Indian Ink	Tusk/Quarter Napa	Perfect White	Ultra Gloss White
Charred Oak	Blackened Elm	Borders Oak	Hickory Walnut	Baroque	Rural Oak	Ranfurly Oak	Nordic Ash

WHEN ORDERING: Complete your chosen product code above by specifying one of the below cabinet finishes in the blank space at the end of the code _
Use **01** for White Melamine; **93** for Charred Oak

WALL HUNG

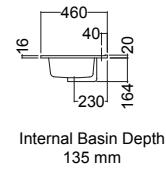
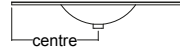
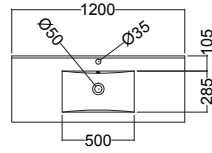
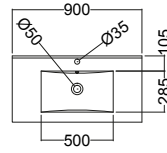
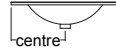
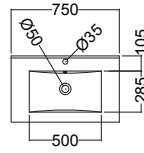

Internal Basin Depth
135 mm

SINGLE DRAWER

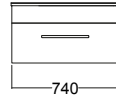

750
4PAC075SN_

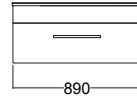

900
4PAC090SN_

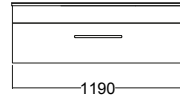

1200
4PAC120SN_

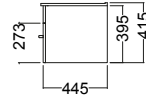

DOUBLE DRAWER

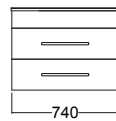

750
4PAC075DW_

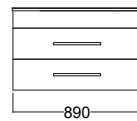

900
4PAC090DW_

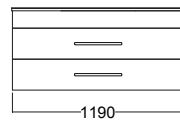

1200
4PAC120DW_

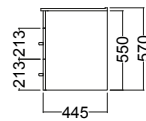

WALL HUNG	750	900	1200
Single Drawer	•	•	•
Double Drawer	•	•	•

See page 22 for additional vanity information



Pacific 750 Single Drawer Wall Hung White Melamine

- Vitreous china top with integrated overflow
- Wall hung cabinet design
- Brushed Nickel handles
- Available in White Melamine or Charred Oak finish only



1200 Double Drawer Wall Charred Oak



750 Double Drawer Wall White Melamine



900 Double Drawer Wall Charred Oak



900 Single Drawer Wall White Melamine

HAND BASINS

WHEN ORDERING: Complete your chosen product code above by specifying one of the below cabinet finishes in the blank space at the end of the code. Use **X** for Ultra Gloss White/Colour(Nikau only); **M** for White Melamine; **G** for Ultra Gloss White; **C** for Colour

NIKAU HAND BASIN

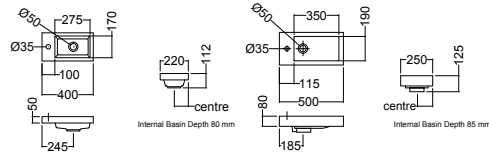

WALL HUNG

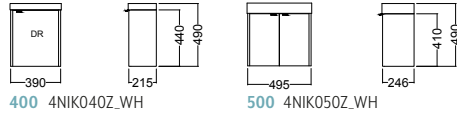

400 4NIK040Z_WH

500 4NIK050Z_WH

FLOORSTANDING

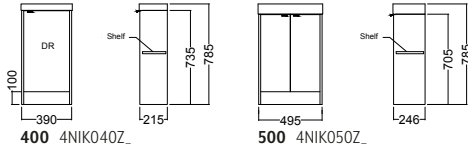

400 4NIK040Z_

500 4NIK050Z_

PINNACLE HAND BASIN

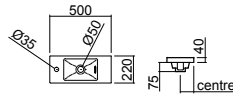

WALL HUNG

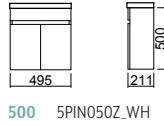

500 5PIN050Z_WH

FLOORSTANDING

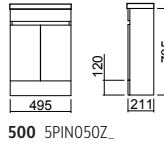

500 5PIN050Z_

CASHMERE HAND BASIN

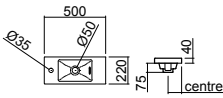

WALL HUNG

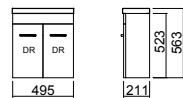

500 5CAS050Z_WH

FLOORSTANDING

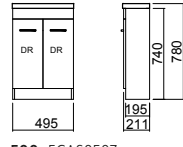

500 5CAS050Z_

MIMAS HAND BASIN

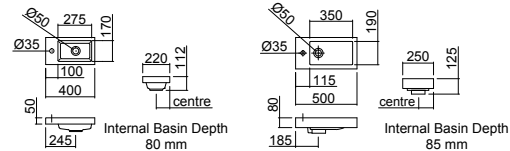

WALL HUNG

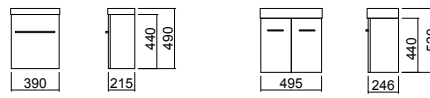

400 4MIM040Z_WH

500 4MIM050Z_WH

FLOORSTANDING



400 4MIM040Z_

500 4MIM050Z_

VEVA HAND BASIN

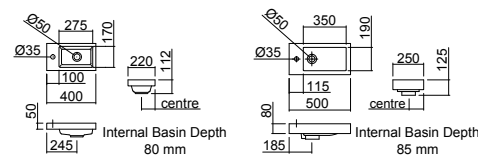

WALL HUNG

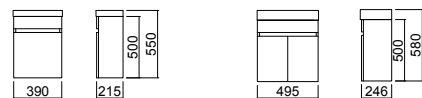

400 4VEV040Z_WH

500 4VEV050Z_WH

FLOORSTANDING

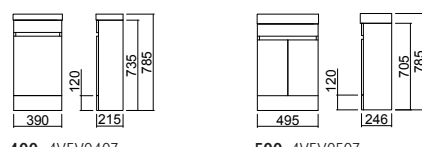

400 4VEV040Z_

500 4VEV050Z_

WALL HUNG	400	500
Cashmere		•
Mimas	•	•
Nikau	•	•
Pinnacle		•
Veva	•	•

FLOORSTANDING	400	500
Cashmere		•
Mimas	•	•
Nikau	•	•
Pinnacle		•
Veva	•	•

Anthracite	Friar Grey	Green Slate	Triple Duck Egg	Indian Ink	Tusk/Quarter Napa	Perfect White	Ultra Gloss White & White Melamine
Charred Oak	Blackened Elm	Borders Oak	Hickory Walnut	Baroque	Rural Oak	Ranfurly Oak	Nordic Ash



Nikau 400 Wall Ultra Gloss White and Baroque



Pinnacle 500 Wall Baroque

NIKAU

- Slimline cabinet with composite top
- Floorstanding or wall hung
- Designed to complement Nikau vanity and tower ranges
- Soft close door RH/LH hinge
- Reversible top, allows the tap to be on the left or right hand side
- Brushed Silver handles are standard with Brushed Gun Metal, Black, Antique Brass and Brushed Bronze handles available as upgrades as shown on page 24
- Single colour cabinet or two tone Nikau design with Ultra Gloss White front panel

Cabinets made in New Zealand

PINNACLE

- Vitreous china top with integrated overflow*
- Reversible top, allows the tap to be on the left or right hand side
- Floorstanding or wall hung
- Negative detail soft close doors
- Available in all Clearlite colours

Cabinets made in New Zealand



Cashmere 500 Wall White Melamine



Mimas 500 Floor Baroque



Veve 500 Floor Charred Oak

CASHMERE

- Vitreous china top with integrated overflow*
- Reversible top, allows the tap to be on the left or right hand side
- Floorstanding or wall hung
- Soft closing doors
- Handles match Cashmere and Statesman
- Brushed Nickel handles are standard with Black & Gunmetal upgrade finishes available (see page 24)
- Available in all Clearlite colours

Cabinets made in New Zealand

MIMAS

- Compact composite basin in two sizes
- Reversible top, allows the tap to be on the left or right hand side
- Floorstanding or wall hung
- Soft closing door/s
- Brushed Nickel handles are standard with Black & Gunmetal upgrade finishes available (see page 24)
- Available in all Clearlite colours

Cabinets made in New Zealand

VEVA

- Compact composite basin in two sizes
- Reversible top, allows the tap to be on the left or right hand side
- 400mm cabinet available as a left or right hand hinge
- Floorstanding or wall hung
- Negative detail soft close doors
- Available in all Clearlite colours

Cabinets made in New Zealand

During manufacture of vitreous china there is shrinkage that is difficult to control, therefore measurements will always be variable. Refer to clearlite.co.nz for full specifications.

MIRRORS & STORAGE

MIRRORS

POLISHED EDGE

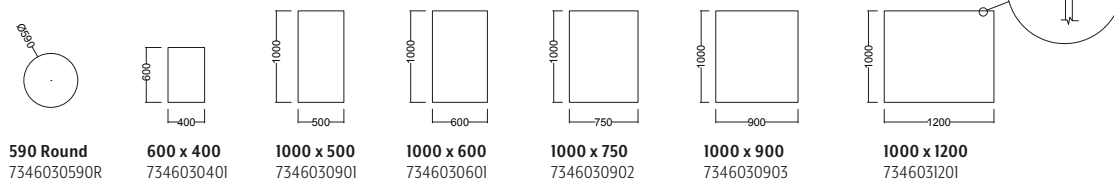

590 Round
7346030590R

600 x 400
734603040I

1000 x 500
734603090I

1000 x 600
734603060I

1000 x 750
7346030902

1000 x 900
7346030903

1000 x 1200
734603120I

BEVELLED EDGE

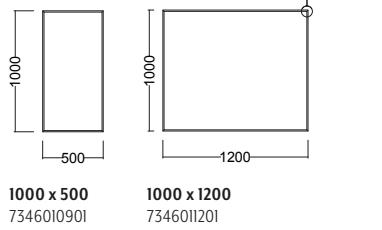

1000 x 500
734601090I

1000 x 1200
734601120I

MAHIA OPEN SHELF

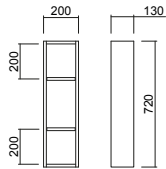

WHITE MELAMINE COLOUR
5MAHOS020M
5MAHOS020C

MAHIA MIRROR CABINET

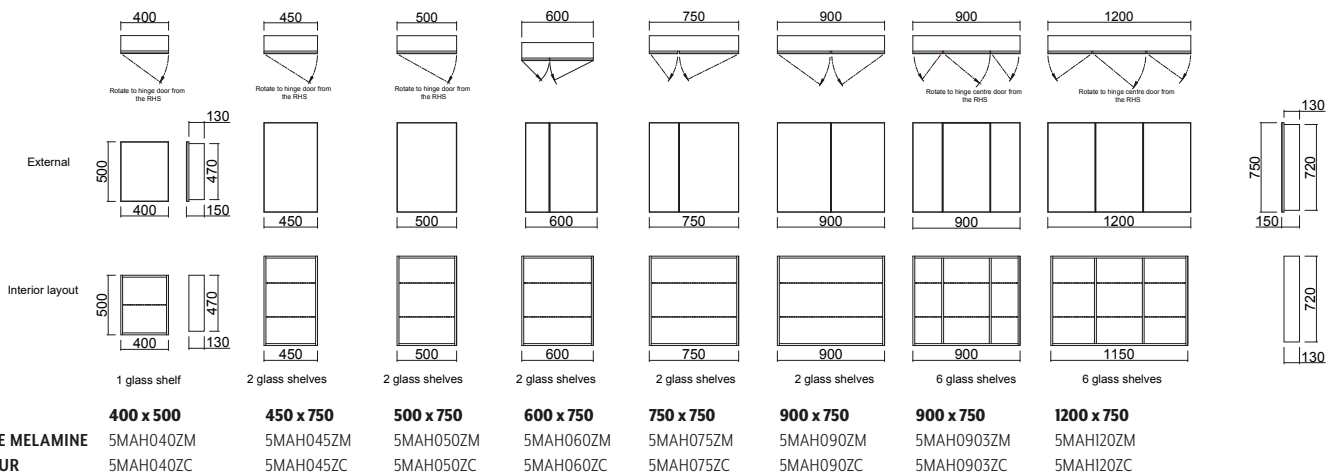

MIRRORS

Clearlite mirrors are fully sealed to prevent moisture damage
 Can be hung vertical or horizontal
 Vinyl backed for additional safety
 Copper & lead free
 2 year warranty
 Includes mounting brackets

POLISHED EDGE

590 Round	7346030590R
600 x 400	7346030401
1000 x 500	7346030901
1000 x 600	7346030601
1000 x 750	7346030902
1000 x 900	7346030903
1000 x 1200	7346031201

BEVELLED EDGE

RUNOUT - LIMITED STOCK AVAILABLE

1000 x 500	7346010901
1000 x 1200	7346011201

Suitable for use with demisters



Polished Edge
1000 x 900 Mirror



Mahia Open Shelf Rural Oak



Mahia 750 x 750 Mirror Cabinet
Rural Oak

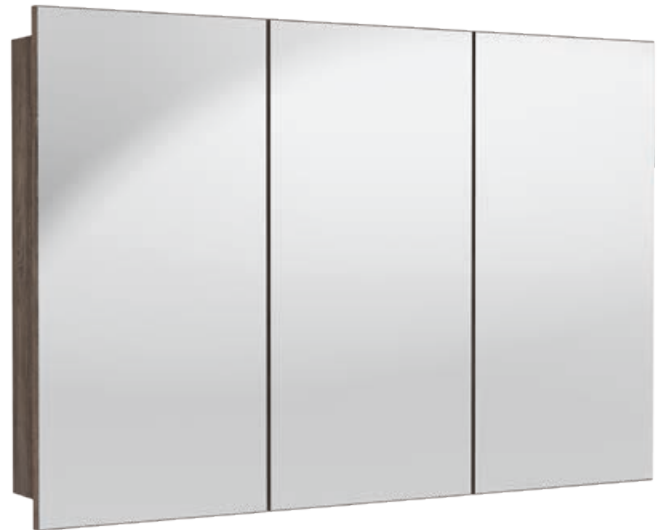

Mahia 1200 x 750 Mirror Cabinet
Blackened Elm

MAHIA OPEN SHELF

Designed to pair with Mahia Mirror Cabinets
 Provides extra storage and display space in the bathroom

MAHIA MIRROR CABINET

Adjustable glass shelving
 Cabinet can be recessed into the wall
 Three door models feature side wing mirrors hinged to give a full viewing perspective

Anthracite	Friar Grey	Green Slate	Triple Duck Egg	Indian Ink	Tusk/Quarter Napa	Perfect White	Ultra Gloss White
Charred Oak	Blackened Elm	Borders Oak	Hickory Walnut	Baroque	Rural Oak	Ranfurly Oak	Nordic Ash

STORAGE TOWERS

WHEN ORDERING: Complete your chosen product code above by specifying one of the below cabinet finishes in the blank space at the end of the code _
Use **X** for Ultra Gloss White/Colour (Nikau only); **M** for White Melamine; **G** for Ultra Gloss White; **C** for Colour

CLASSIC

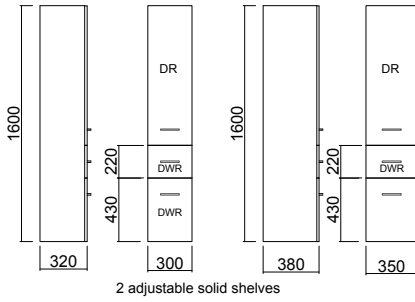

300
5TCLS030Z_

350
5TCLS035Z_

TWO DOOR

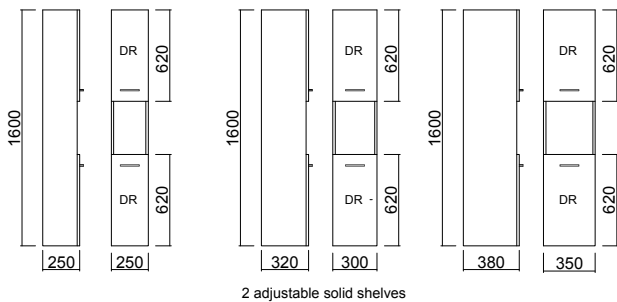

250
4TDR025Z_

300
4TDR030Z_

350
4TDR035Z_

PINNACLE

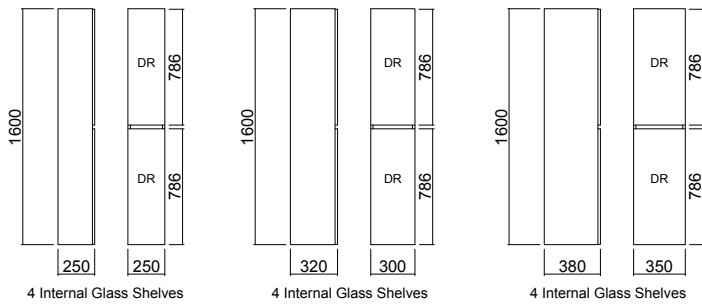

250
4TPIN025Z_

300
4TPIN030Z_

350
4TPIN035Z_

NIKAU

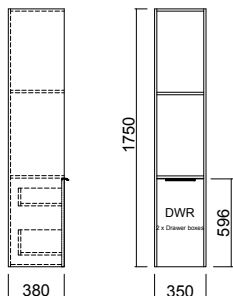

350
4TNIK035Z_

CLASSIC

Available in all Clearlite colours
 Left or right hand hinged
 Soft close doors and drawers
 Select handle style to complement vanity
 Brushed Nickel handles are standard with
 Black & Gunmetal upgrade finishes available
 (see page 24)

Made in New Zealand



Classic 350 Storage Tower
 One Door Two Drawers Blackened Elm

TWO DOOR

Standard or Slimline styles
 Available in all Clearlite colours
 Left or right hand hinged
 Soft close doors
 Select handle style to complement vanity
 Brushed Nickel handles are standard with
 Black & Gunmetal upgrade finishes available
 (see page 24)

Made in New Zealand



Two Door 350 Storage Tower
 Hickory Walnut

PINNACLE

Negative detail soft close doors
 Available in all Clearlite colours
 Left or right hand door opening
 Complements Pinnacle vanities

Made in New Zealand



Pinnacle 350 Storage Tower
 Rural Oak

NIKAU

Features open display shelving
 Soft close storage drawer
 Brushed Silver handles are standard with
 Antique Brass, Antique Bronze, Brushed
 Black & Brushed Gunmetal upgrade finishes
 available (see page 24)
 Single colour cabinet or two tone Nikau
 design with Ultra Gloss White front panel
 Available in all colours except White
 Melamine

Made in New Zealand

*Not available in White Melamine



Nikau 350 Storage Tower
 Baroque

Anthracite	Friar Grey	Green Slate	Triple Duck Egg	Indian Ink	Tusk/Quarter Napa	Perfect White	Ultra Gloss White & White Melamine
Charred Oak	Blackened Elm	Borders Oak	Hickory Walnut	Baroque	Rural Oak	Ranfurly Oak	Nordic Ash

BATHS & ACCESSORIES

Clearlite baths are available in a range of styles and sizes to suit any New Zealand bathroom. Our baths are constructed from the highest quality materials to be both functional and timeless in design.



Clearlite acrylic baths, wall liners and door sets* are proudly manufactured in New Zealand. *excluding our imported Varo Back to Wall Bath



Aluminium upstand

CUSTOM UPSTANDS

Aluminium upstands are recommended in shower over bath situations. The upstands are custom fitted in our factory and enable a water tight seal between the bath and wall lining (or tiles). This allows the installer to apply sealant above the baths surface, preventing a visible seal that can discolour or mould.



TIMBER BATH FRAMES

Drop in baths have the option of being supplied with a timber frame which we custom fit to support the bath floor. Timber bath frames are made from machined gauge pine which is straight and true to allow easy fixing of lining materials. This is a cost effective solution which saves time onsite by eliminating the need to frame up once the bath has been delivered. Note: frames are factory fitted or supplied separately.



ACRYLIC BATH SKIRTS

Offering a simple solution to finishing off the surround of a drop in, acrylic bath skirts are available in one and two or three sided configurations to suit your design.



SENOSAN ACRYLIC WALLS & LINERS

Clearlite wall liners use Senosan from Senoplast that brings you an unbeatable advantage of:

- Brilliant surface of sanitary acrylic
- Warm surface
- Long life in use
- Excellent design possibilities

SENOSAN[®]
SENOPLAST



SAFETY GLASS

Bathroom projects may need to obtain a code of compliance. All Clearlite Shower over Bath door sets and swing panels are manufactured with this in mind, using toughened safety glass complying with AS/NZS2208.



BACK TO WALL BATH

VARO

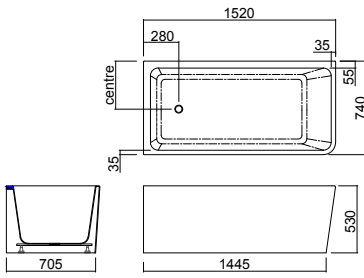

1520 BATH LEFT HAND
NO UPSTANDS 0154000003
WITH UPSTANDS 0154000003U

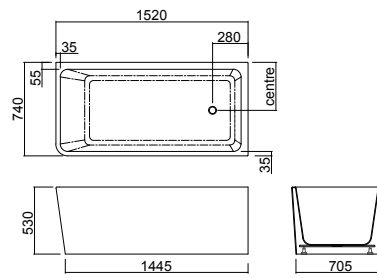

1520 BATH RIGHT HAND
NO UPSTANDS 0154000004
WITH UPSTANDS 0154000004U

1520 SHOWER OVER BATH PACKAGES

	STANDARD SWING	PLATINUM SWING
2 Wall Flat (LH)	OB69002FSL	OB69002FPL
2 Wall Moulded (LH)	OB69002MSL	OB69002MPL

1520 SHOWER OVER BATH PACKAGES

	STANDARD SWING	PLATINUM SWING
2 Wall Flat (RH)	OB69002FSR	OB69002FPR
2 Wall Moulded (RH)	OB69002MSR	OB69002MPR

BATH RANGE SPECIFICATIONS

BATH	1520	1525	1655	1675	1800
Pacific		•	•		
Matisse			•		
Kahlo				•	•
Varo Drop In		•		•	•
Varo Back to Wall	•				

All Dimensions are nominal.

* Water capacities are measured internally 80mm from the top

	Size (l x w x d) External Dimensions	Internal Depth (Excludes upstands)	Water Capacity* (L)
Varo	1525 x 740 x 450mm	450	210
Varo	1675 x 750 x 450mm	470	254
Varo	1800 x 800 x 485mm	485	300
Varo Back to Wall	1520 x 740 x 535mm	440	200
Pacific	1525 x 740 x 405mm	370	153
Pacific	1655 x 740 x 405mm	370	173
Matisse	1655 x 740 x 420mm	380	164
Kahlo	1675 x 800 x 480mm	480	254
Kahlo	1800 x 800 x 490mm	490	290
Dina Shub	1200 x 820 x 440mm	420	125

VARO

BACK TO WALL BATH



Varo 1520 Back to Wall Bath

VARO BACK TO WALL

Left or Right hand bath options

Sits flush against the wall

Large internal space for its size due to narrow external edge

Perfect shape for shower over bath due to the near vertical internal shaped end

Adjustable feet for levelling

Factory fitted 25mm upstands are recommended when bath is positioned against a wall, see page 56

Shower over bath options, see page 65 for specifications

Sizes (LxWxD): 1520x740x530mm

DROP IN BATHS

PACIFIC

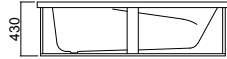
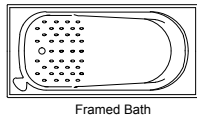
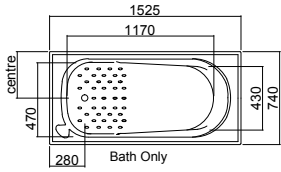

Height includes upstand

Height includes upstand

1525 BATH

011000006

1525 FRAMED BATH

05900003

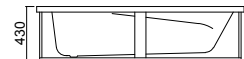
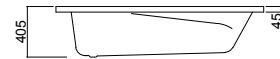
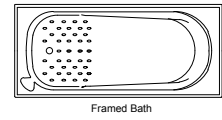
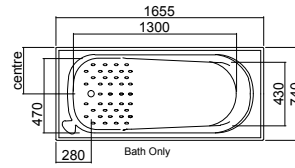

Height includes upstand

Height includes upstand

1655 BATH

010800006

1655 FRAMED BATH

05900002

SHOWER OVER BATH PACKAGES

	STANDARD SWING	PLATINUM SWING
2 Wall Flat	OB10002F	OB61002F
2 Wall Moulded	OB10002M	OB61002M
3 Wall Flat	OB10003F	OB61003F
3 Wall Moulded	OB10003M	OB61003M

SHOWER OVER BATH PACKAGES

	STANDARD SWING	PLATINUM SWING
2 Wall Flat	OB08002F	OB60002F
2 Wall Moulded	OB08002M	OB60002M
3 Wall Flat	OB08003F	OB60003F
3 Wall Moulded	OB08003M	OB60003M

MATISSE

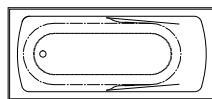
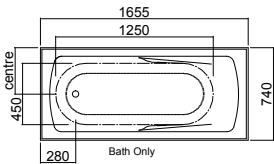

Height includes upstand

Height includes upstand

1655 BATH

015000006

1655 FRAMED BATH

05900013

SHOWER OVER BATH PACKAGES

	STANDARD SWING	PLATINUM SWING
2 Wall Flat	OB50002F	OB67002F
2 Wall Moulded	OB50002M	OB67002M
3 Wall Flat	OB50003F	OB67003F
3 Wall Moulded	OB50003M	OB67003M

DROP IN BATHS

PACIFIC VALUE RANGE

- Contoured arm rests and lumbar support
- Anti slip tread pattern on base
- Features full perimeter moulded upstand
- Wooden support frame and bath skirts available
- Shower over bath options, see page 65
- Sizes (LxWxD): 1525x740x405mm
1655x740x405mm

Made in New Zealand



Pacific 1655 Bath

MATISSE

- Lumbar support and arm rests
- Features full perimeter moulded upstand
- Wooden support frame and bath skirts available
- Shower over bath options, see page 65
- Sizes (LxWxD): 1655x740x420mm

Made in New Zealand



Matisse 1655 Bath

DROP IN BATHS

VARO

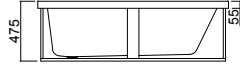
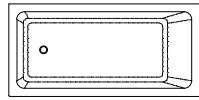
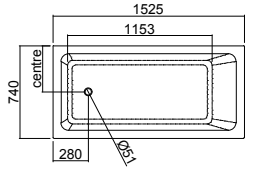

Height with optional upstand 465 mm

Height with optional upstand 490 mm

1525 BATH
NO UPSTANDS 0154000005
WITH UPSTANDS 0154000005U

1525 FRAMED BATH
 05900019
 05900019U

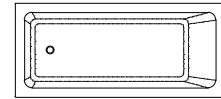
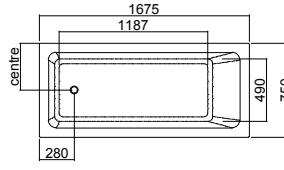

Height with optional upstand 485 mm

Height with optional upstand 525 mm

1675 BATH
NO UPSTANDS 0154000006
WITH UPSTANDS 0154000006U

1675 FRAMED BATH
 05900016
 05900016U

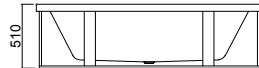
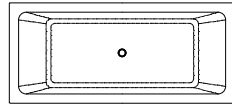
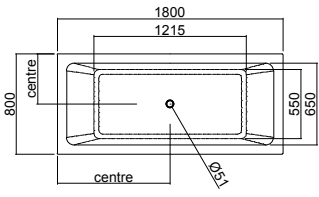

Height with optional upstand 500 mm

Height with optional upstand 525 mm

1800 BATH
NO UPSTANDS 0154000008
WITH UPSTANDS 0154000008U

1800 FRAMED BATH
 05900018
 05900018U

KAHLO

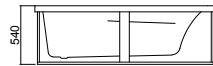
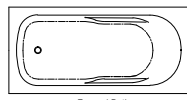
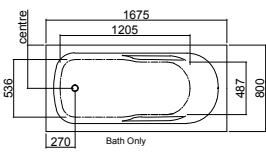

Height with optional upstand 495 mm

Height with optional upstand 555 mm

1675 BATH
NO UPSTANDS 0151000006
WITH UPSTANDS 0151000006U

1675 FRAMED BATH
 05900014
 05900014U

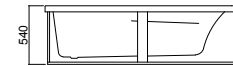
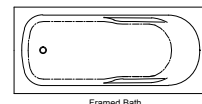
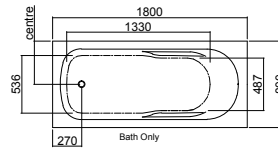

Height with optional upstand 505 mm

Height with optional upstand 555 mm

1800 BATH
NO UPSTANDS 0152000006
WITH UPSTANDS 0152000006U

1800 FRAMED BATH
 05900015
 05900015U

DROP IN BATHS

VARO DROP IN

Elegant minimalist design

Wooden support frame and bath skirts available

Factory fitted 15mm upstands are recommended when bath is positioned against a wall, see page 56

Shower over bath options, see page 65

Sizes (LxWxD): 1525x740x450mm
1675x750x470mm
1800x800x485mm

Made in New Zealand



Varo 1675 Bath

KAHLO

Contoured arm rests

Wooden support frame and bath skirts available

Factory fitted 15mm upstands are recommended when bath is positioned against a wall, see page 56

Shower over bath options, see page 65

Sizes (LxWxD): 1675x800x490mm
1800x800x490mm

Made in New Zealand



Kahlo 1675 Bath

COMPACT BATH / SHOWER OVER BATH



DINA SHUB

Compact 'shower over tub' design
 Anti slip tread pattern on base
 Full perimeter moulded upstand
 Shower over bath packages available
 1505mm wall liner and semi frameless return panels available for compact enclosure
 Sizes (LxWxD): 1200x820x440mm

Made in New Zealand

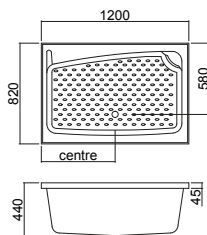

1200 X 820
SHUB ONLY 012000006

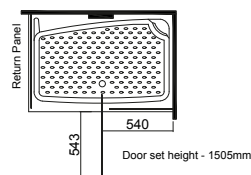

SHOWER OVER 2 SIDED
FLAT WALL 0B20002F
MOULDED WALL 0B20002M

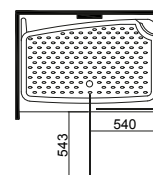

SHOWER OVER 3 SIDED
FLAT WALL 0B20003F
MOULDED WALL 0B20003M

BATH WALL LINER

Flat or moulded one piece Senosan® acrylic wall lining*
 2 and 3 sided options available
 1530 high
 Custom size liners also available

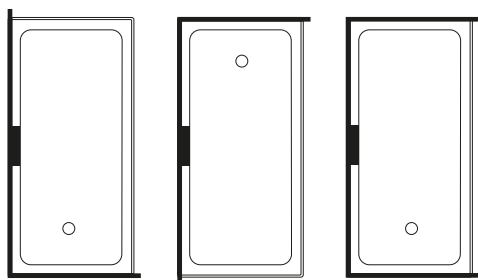

■ Indicates standard moulded soap recess position (centre)
 *Kahlo baths not available with moulded 3 sided liner



Dina Shub 2 Sided
 Flat Wall Enclosure



Matisse 1525 Shower over Bath
3 Sided Flat Wall Liner, Standard Swing Panel with added frame

STANDARD SWING PANEL

- 900 x 1500 pivoting swing panel
- 6mm clear safety glass complies with AS/NZS 2208
- Panel swings inside and outside of bath
- Drip seal fitted to bottom of glass to deflect splashes
- White finish joinery

Made in New Zealand

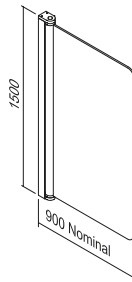

10090095 STANDARD 900 SWING PANEL FOR BATH WITHOUT FRONT UPSTAND



Varo 1520 Back to Wall Shower over Bath
2 Sided Moulded Wall Liner, Platinum Swing Panel

PLATINUM SWING PANEL

- 1100 x 1500 hinged swing panel
- 6mm clear safety glass complies with AS/NZS 2208
- Chrome hinges
- Support bracket provides a handy shelf
- Panel swings inside and outside of bath
- Fixed panel allows clearance when positioned next to a standard size vanity
- Drip seal fitted between glass and edge of bath to deflect splashes
- Satin finish joinery
- Optional sill kit for baths without upstands

Made in New Zealand

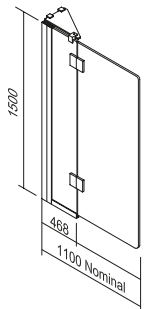

09800360 PLATINUM SWING PANEL 1100 FOR BATH WITH FULL PERIMETER UPSTAND

09800365 PLATINUM SWING PANEL 1100 FOR BATH WITHOUT FRONT UPSTAND

COMPLETE DOOR SET

- Available to suit Pacific and Matisse Baths
- Door features 6mm clear safety glass complying with AS/NZS 2208
- Full length aluminium handle incorporating magnetic closure
- White finish joinery
- Door can be left or right hand opening

Made in New Zealand

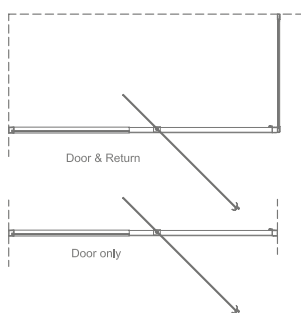

Please refer to website for full dimensions



Pacific 1655 2 Sided Flat Wall
and Complete Door Set

Shower Master

ShowerMaster products are designed with kiwi homes in mind, featuring a range of cleaning, storage and design solutions to enhance your bathroomware. For full specifications and RRP's visit Clearlite.co.nz – Spare Parts

Vanity Drawer Organisers

Matt finish recyclable ABS thermoplastic with non slip feet
Stylish storage solutions



320x110mm 2 Zone + lids,
fixed divider 7345040225



320x210mm 3 Zone,
removable dividers 7345040230

Vibrance Surface Cleaner

STEP 1: to remove everyday soap build up
Suitable for use on Vitreous China, Acrylic, Solid and
Tiled Surfaces



500ml Spray
Made in NZ
090185



5L Bulk Refill
Made in NZ
090186

Vibrance Surface Polish

STEP 2: to restore lustre, remove light
scuff marks and leave a protective film
Designed for use on
Vitreous China, Acrylic,
Solid and Tiled Surfaces



500ml Flip Lid
Made in NZ
090183

Basin Bottle Traps 32mm

Easy to install
Vertical and horizontal pipes can
be cut to suit



Chrome QCW50089



**RUNOUT -
LIMITED STOCK
AVAILABLE**
Black QCW50090

Glass Shower Shelves

10mm toughened A Grade safety glass
2 x chrome brackets and hardware for acrylic walls included



300x160 Elliptical
7345040201



200mm Semi Round
7345040200



Footrest 125mm Curved
7345040203



3 x Shelves & Squeegee Kit 7345040220

Stainless Steel Shower Squeegee

Silicone blade and
hanging bracket
included
260mm wide
7345040210



Replacement Shelf Brackets

2 piece set
Satin Black 7345040202
Polished Chrome QCS15775

Basin Overflow Ring 22mm

Plated Brass suitable for basins
with overflows



Chrome
7345040205



Black
7345040204

Basin Pop Up Waste 32mm

Plated Brass suitable for basins
with overflows



Chrome QCW50085



Black QCW50086

Bath Pop Up Waste 40mm

Plated Brass suitable for baths
with overflows



Chrome QCW50087



Black QCW50088

WARRANTIES & MAINTENANCE

PRODUCT WARRANTY

We stand behind our products and offer warranties on all our bathroomware so that you have peace of mind that what you have purchased for your home is of the highest quality and fits the purpose for which it was designed.

WARRANTY PERIODS

Baths - 5 Years

Vanities and Basins - 5 Years

Storage Towers - 5 Years

Mirrors and Demister Pads - 2 Years

Showers - 10 Years

Door set, acrylic wall liner, Sure Seal™ tray and EasyClean Waste body

Showers - 1 Year

Drip strips, vertical seals and waste lid

EXCLUSIONS

- The product must be installed according to the instructions supplied.
- The supply water temperature at the tap must not exceed 50°C
- Commercial applications - 12 month warranty on all products

PRODUCT MAINTENANCE

As the bathroom can be a high use zone in the house, it is important to understand how to maintain products. Below are our suggestions on how to clean and care for them.

SHOWER CARE

- Wipe down the shower or use a plastic squeegee to remove excess water from the glass after use
- Use a trusted glass cleaner on shower glass. If your glass has been treated with Diamond Fusion, please go to <https://www.diamondfusion.co.nz/product-instructions/> for cleaning instructions
- Use Vibrance Surface Cleaner to clean the tray and wall liner
- Waste lid and cup should be removed and cleaned regularly
- Drips seals can be removed for cleaning and can simply be replaced when they no longer look their best

VANITY / BASIN / STORAGE TOWER / MIRROR CARE

- Wipe any spilled liquids from the vanity as soon as possible. Cabinets are water resistant not waterproof
- **Ultra Gloss Cabinet Finishes:** only use a damp cloth to clean
- **Woodgrain and Standard Melamine Cabinet Finishes:** for best results use Vibrance Surface Cleaner or a gentle streak free glass cleaner using a soft cloth
- **Stone Bench Tops;** only use a damp cloth to clean
- **Acrylic, Composite, Vitreous China and Solid Surface Vanity Tops and Basins:** use Vibrance Surface Cleaner. Light scratches can be removed from an Acrylic or Composite vanity top by using 'Brasso' or 1200 grit 'wet & dry' sandpaper, followed by polishing with a fine car cutting compound. For deep scratches, we recommend an experienced Acrylic Repairer is contacted
- **Glass and Mirrors:** for best results we recommend the use of a trusted glass cleaner

BATH CARE

- Clean regularly with warm, soapy water using a non abrasive cleaner.
- Light scratches can be removed from an Acrylic bath by using 'Brasso' or 1200 grit 'wet & dry' sandpaper, followed by polishing with a fine car cutting compound. For deep scratches, we recommend an experienced Acrylic Repairer is contacted.

VIBRANCE SURFACE POLISH AND CLEANER

Suitable for use on Acrylic, Vitreous China, Porcelain, Tiled and Solid Surfaces

Step 1: Use ShowerMaster Vibrance Surface Cleaner for daily cleaning

Step 2: Use ShowerMaster Vibrance Surface Polish to restore lustre, remove light scuff marks and leave a protective film

Developed and manufactured in New Zealand specifically for Clearlite and Athena bathroomware.

Note: Before using on other products it should be tested on an inconspicuous area.



We are here to help. If you would like further information on your Clearlite product or additional cleaning instructions, please contact our After Sales team; P; 09 444 3780 | E: aftersales@clearlite.co.nz

CLEARLITE

BATHROOMS

clearlite.co.nz



HEAD OFFICE, FACTORY, WAREHOUSE AND SHOWROOM

54-58 Hillside Rd, Glenfield, Auckland 0627
Private Bag 40902, Glenfield, Auckland 0747 P (09) 444 3780 E info@clearlite.co.nz

CHRISTCHURCH WAREHOUSE

117 The Runway, Wigram, Christchurch 8042 P (03) 339 0186

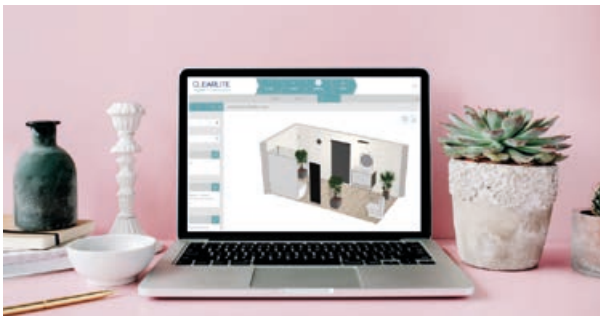

CLEARLITE BATHROOM PLANNER: BRINGING YOUR IDEAS TO LIFE

Whether you are a home owner, bathroom specialist or a renovation expert, we can help you redesign an existing space or create a brand new dream bathroom today!

With our in-house consultant, no matter what stage you are at, we are here to help you through it.

clearlite.co.nz/pages/3d-bathroom-planner

Note: Clearlite retains the right to change products and specifications without notice. Handle styles in particular can vary as new designs become available. This brochure does not constitute an offer by Clearlite and is not intended as an exhaustive description of product performance for suitability. All measurements are nominal. This brochure supersedes all previous brochures. This edition is effective December 2023. Tapware and accessories shown in this brochure are for photography purposes only. Colour reproduction is as near to actual colour as printing methods allow. Clearlite supports but does not endorse partner products. E&OE - Errors and Omissions Excepted (Excused). We endeavour to keep all information as accurate as possible; however, errors will occur from time to time, due to the large scale, number of product lines and nature of our business.