

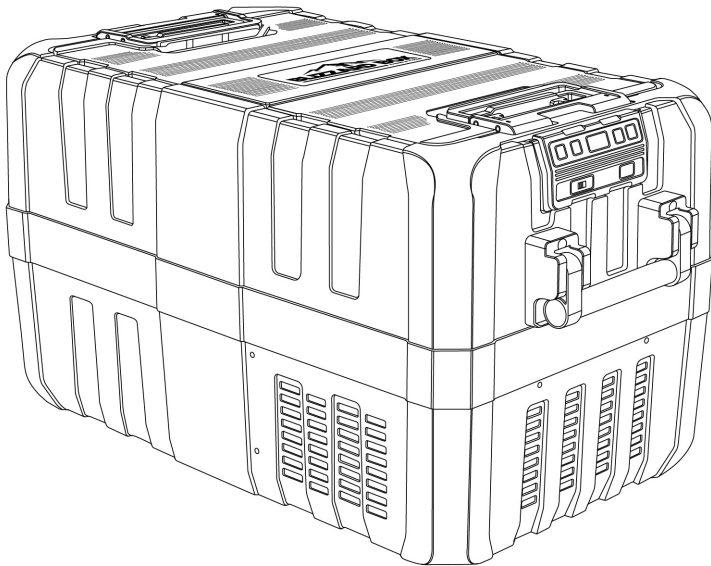

PORTABLE FRIDGE / FREEZER
41 Quart



AC57245-1

INSTRUCTION MANUAL

PLEASE READ THIS USER MANUAL CAREFULLY BEFORE CONNECTING AND OPERATING APPLIANCE.
SAVE FOR FUTURE REFERENCE.

PACKAGE CONTENTS:

Blizzard Box

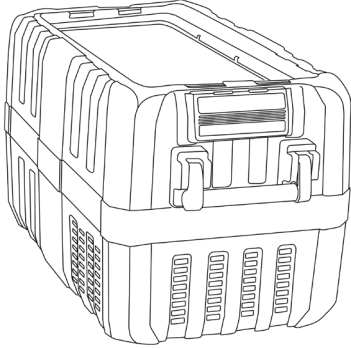

Blizzard Box Lid

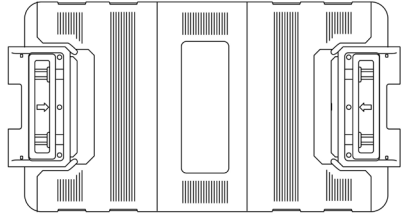

Instruction Manual

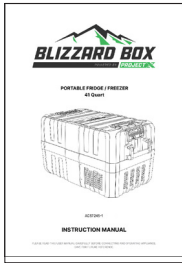

12/24V
DC Power Cord -
9 1/2'

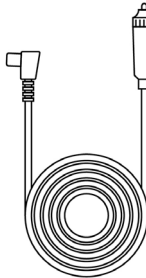

AC to DC
Power Adapter -
6' Cord

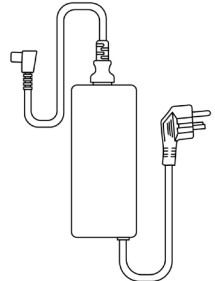

Small
Storage Basket

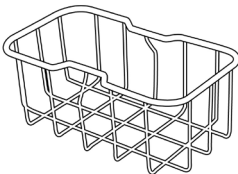

Large
Storage Basket

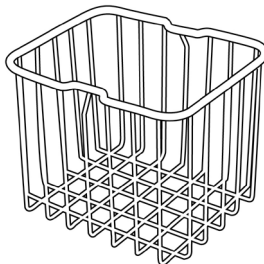

Output: 24VDC 4.75Amp*
see footnote on page 15.

Input: 100-240 VAC,
2.0Amp Max.

TECHNICAL SPECIFICATIONS

| | 41Quart (38L) |
|--------------------------|---|
| Weight | 35 lbs |
| Capacity | 41 QT (389L) |
| USB Charging Port Output | 5V / 1.5A rating |
| Cooling Performance | 0°F - 50°F |
| Climate Class | 50°F - 109°F (SN/N/ST/T) |
| Compressor | SECOP PBC-2.0 |
| Refrigerant | R134a (60g) |
| Insulation | CFC-free PU foam |
| Power Consumption | Dual Voltage; 5W (5.6A) @ 12VDC or 65W (2.8A) @24VDC (as needed*) |
| Input Rating | 12VDC, 5.6A 24VDC, 2.8A |

Power consumption "as needed*" foot note, see page 15.

DIMENSIONS (Including handles)

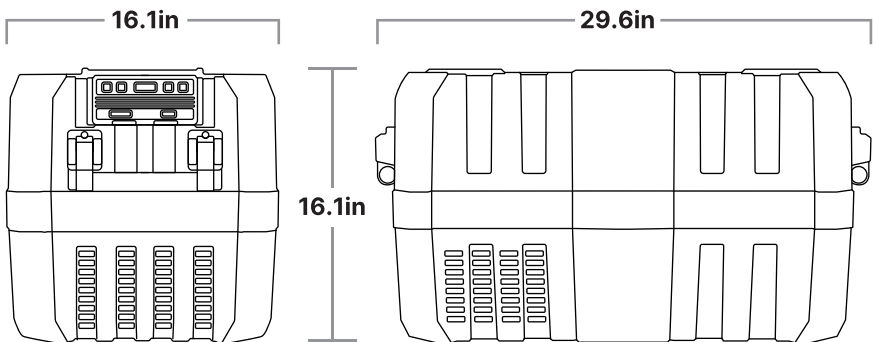

OPERATION:

BEFORE YOU START

CAUTION!

- To reduce the chances of overheating, keep your Blizzard Box in an open area, to not obstruct the heat dissipation side ventilation openings. Ensure these side vents are not blocked while in use, or shortly after use.
- Use in dry conditions.
- Do not use near heat sources such as gas ovens, heaters, or direct sunlight.
- Do not immerse in water.
- Do not fill with liquid or ice.
- Do not use in direct sunlight or near flames / fire.
- Ensure Blizzard Box, cables, and charging inputs / outputs are not exposed to direct moisture or heat.

1. Connecting power

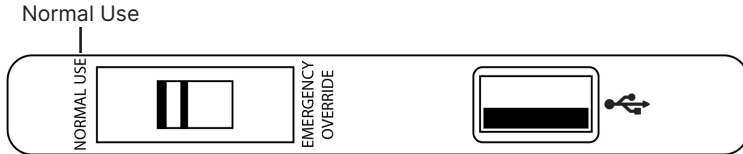

The red slide switch on the Operating Panel should be to the left during “normal use.”

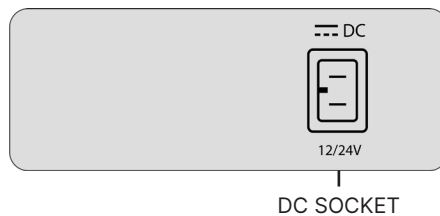

Insert DC plug into vehicle's power port. You may also use the included 110V AC to 12V DC Power Adapter for household power.

OPERATION CONTINUED:

2. Operating panel

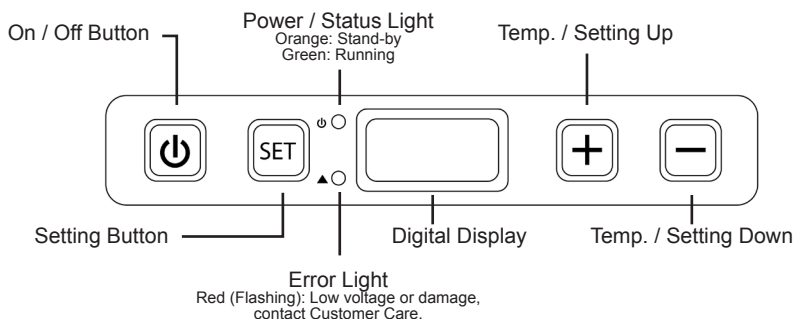





3. Turning on Blizzard Box

After connecting power to your Blizzard Box, the Power Light Indicator on the Operating Panel will be Orange. The Digital Display will be blank.

Press and hold the On / Off Button for three seconds. The Digital Display will then show the current interior temperature. Once the Power Light turns Green, your Blizzard Box is operating.

4. Setting the temperature

- Press  button once, start setting temperature status.
- Use  /  to set temperature from 0°F to 50°F or -18°C to 10°C.
- The cooling temperature will be displayed for a few seconds. The Digital Display will flash several times before the current interior temperature is displayed.
- Press  button once again, start exchange status for Fahrenheit degree (°F) and centigrade degree (°C).

OPERATION CONTINUED:

- Use  /  to switch between Fahrenheit and Centigrade. The cooling temperature appears on the display for a few seconds. The display flashes several times and then the current interior temperature is displayed again.

NOTE

If the ambient outdoor temperature is above +90°F (+32°C), the minimum setting temperature cannot be attained. 

When Blizzard Box interior temperature reaches the desired temperature setting, the compressor will stop. The Power Light will turn to Orange.

5. Turning off the Blizzard Box

In working status, press and hold the  button for three seconds to turn off the Blizzard Box. Pull out power plug.

6. Emergency Override Mode

Two 1A USB Ports allow you to charge most mobile devices.

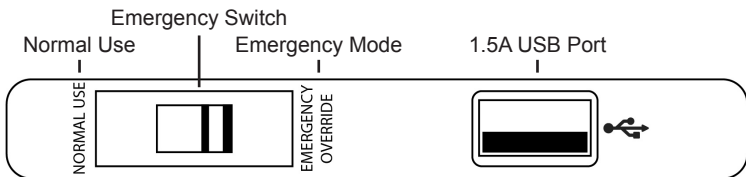

Emergency Override Mode is for temporary use only.

When Emergency Override is activated this will override the “Vehicle Battery Protection” setting and the “Preset Temperature”. The pump will cool full time and the Blizzard Box will try to achieve lowest temperature possible below freezing.

Emergency Override Mode will restart the Blizzard Box to run at a voltage below the preset of the battery protection. During the voltage override, the Blizzard Box will run with the Orange Stand-by Light. Digital Display will not be available.

Emergency Override Mode can also be used to keep the Blizzard Box running if the Operation Panel malfunctions.

OPERATION CONTINUED:

To confirm if the Blizzard Box is running, feel for the air flow, or listen for sound from ventilation openings on either side of the appliance. (See image on page 3)

NOTE

When using Emergency Override Mode, the vehicle battery can drain rapidly.

The selected mode then appears on the display for a few seconds.

The display flashes several times before it returns to the current temperature. (Reference Section 9 for more information)

7. Vehicle Battery Protection Setting

The Blizzard Box is equipped with multi-level vehicle battery protection that guards against excessive discharging when connected to a 12V / 24V power source.



If the Blizzard Box is operating when the vehicle ignition is switched off, it will be switched off automatically once the supply voltage falls below the cut-off level. The Blizzard Box will switch back on once the vehicle battery has been recharged to the restart voltage level (See table in Section 9).

NOTICE! Avoid Damaging Vehicle Battery

If the Vehicle Battery Protection Setting becomes activated and switches off the Blizzard Box, the vehicle battery will NOT be fully charged. Avoid restarting the vehicle repeatedly, or operating the radio before the vehicle battery has fully recharged via running engine.

Ensure that the battery is recharged.

-Press the  button three times.

-Use the  /  buttons to select the Vehicle Battery Protection Setting.

Digital Display will be as follows:

Lo (LOW), **ME** (MED), **HI** (HIGH)

OPERATION CONTINUED:

8. USB port for power supply

1.5A USB Port allows you to charge most mobile devices.

9. Setting Vehicle Battery Protection / Low Voltage Battery Protection

When the vehicle battery's voltage drops to the below setting, the Blizzard Box compressor will turn off. This will protect the vehicle battery from over discharge. The Error Light will flash Red to alert you to charge the battery by running the engine. The Orange Stand-by Light will remain on.

Voltage Range: Vehicle Battery Protection:

| Power Supply | Status Battery Protector | Low Mode | Medium Mode | High Mode |
|--------------|--------------------------|-----------|-------------|-----------|
| DC 12V | Cut-off Voltage | 10.1±0.3V | 11.4±0.3V | 11.8±0.3V |
| | Restart Voltage | 11.1±0.3V | 12.2±0.3V | 12.6±0.3V |
| DC 24V | Cut-off Voltage | 21.5±0.3V | 24.1±0.3V | 24.6±0.3V |
| | Restart Voltage | 23.0±0.3V | 25.3±0.3V | 26.2±0.3V |

(Reference Section 5 Vehicle Battery Protection Setting)

When the Blizzard Box is powered by a vehicle starter battery, High Mode Setting is recommended to warrant the vehicle's battery power is high enough to ensure starting.

If you use an additional battery (RV, campers) as a power supply, Low Mode Setting is recommended.

If you use an AC 110V Power Converter (included), set the Battery Protection Setting to Low Mode.

After power loss or shutting off the Blizzard Box will retain last setting and will restart when power is restored.

OPERATION CONTINUED:

10. 3-Position Lid

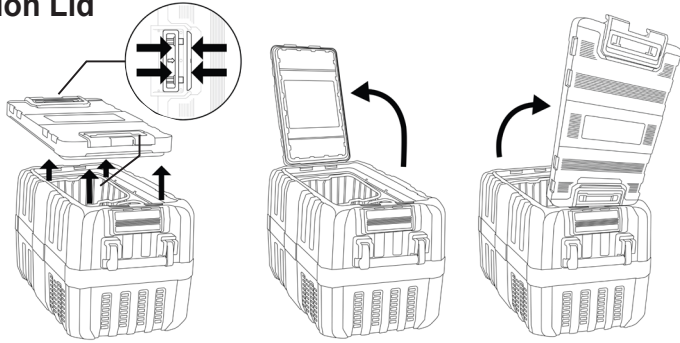

11. Temperature Tips

| Suggested Storage Temperatures | Temp. |
|--|-------------------|
| Beer (Light), Sparkling Wines, Champagne | 41°F / 5°C |
| Beer (Craft), White Wine | 46°F / 8°C |
| Beer (Rich flavor), Red Wine | 53°F / 12°C |
| Soda / Pop | 40°F / 4°C |
| Fruit & Veggies (Cool Season) | 32-35°F / 0-1.6°C |
| Fruit & Veggies (Warm Season) | 45-55°F / 7-12°C |
| Meat & Fish | 41°F / 5°C |
| Dairy | 35°F / 1.6°C |
| Eggs | 45°F / 5°C |

- Blizzard Box is designed to maintain chilled temperatures of food and beverages.
- Pre-cool Blizzard Box before storing food or beverages.
- Pre-cool food or beverages before storing in Blizzard Box.
- Baskets are important to protect inner walls and to even-out the cooling temperature.
- The use of a fridge cover transit bag is recommended to protect against dings or damage and it adds an insulated layer to assist in temperature control.
- Avoid leaving the lid open for extended periods of time

OPERATION CONTINUED:

Cleaning and Maintenance

WARNING: Always disconnect Blizzard Box from power before cleaning or servicing.

WARNING: Do not use abrasive cleaning agents or hard objects during cleaning as these can damage the Blizzard Box.

- Occasionally clean the device interior and exterior with a damp cloth.
- If you have a Blizzard Box cover, wipe down the cover after use to help reduce mold build up from condensation
- Clean heat dissipation window frequently to ensure good heat dissipation.
- Do not turn Blizzard Box on its side or upside down. Keep upright.
- If not in use leave lid open to prevent mold from developing inside of the fridge.

Defrosting: Humidity can form frost in the interior of the cooling device or on the evaporator. This reduces the cooling capacity.

Defrosting steps are as below:

- Remove the contents from the Blizzard Box and store them in another cooler if necessary.
- Disconnect the power of the Blizzard Box. Open the lid, and keep it open until the ice and frost melt away.
- Use clean cloth to wipe up the defrosted water.
- Never use hard or pointed tools to remove ice or to loosen objects which have frozen in place.

Replacing a defective fuse:

- Unplug the DC power plug;
- Turn the cap counter-clockwise to open it, and remove the defective fuse from the plug;
- Insert a new fuse that has the same rating (15A 250V);
- Close and tighten the cap.

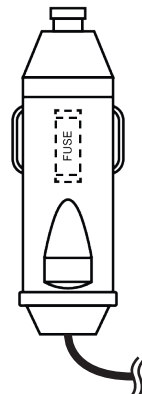

WARNING:

IMPORTANT SAFETY INSTRUCTIONS

1. SAVE THESE INSTRUCTIONS – This manual contains important safety and operating instructions.
 2. Before using this product, read all instructions and cautionary markings.
 3. Do not expose the product to rain, moisture, or snow.
 4. Use of an attachment not recommended or sold by the product manufacturer may result in a risk of fire, electric shock, or injury to persons.
 5. To reduce risk of damage to cigarette lighter connector and cord, pull by cigarette lighter connector rather than cord when disconnecting the product.
 6. Make sure cord is located or routed so that it will not be stepped on, tripped over, or otherwise subjected to damage or stress.
 7. Do not operate with damaged cord or cigarette lighter connector – replace it immediately.
 8. Do not operate the product if it has received a sharp blow, been dropped, or otherwise damaged in any way; take it to a qualified service person.
 9. Do not disassemble the product; take it to a qualified service person when service or repair is required. Incorrect reassembly may result in a risk of electric shock or fire.
 10. To reduce risk of electric shock, unplug charger before attempting any maintenance or cleaning. Turning off controls will not reduce this risk.
- Pay attention to the voltage description on the rating label, and ensure that the power cord is connected to right power outlet.
 - If either of the provided power cables are damaged they must be replaced by PROJECT X, customer service or a similarly qualified person in order to prevent safety hazards.
 - Disconnect the power supply prior to cleaning, maintenance or stop use.

NOTICE! Danger of damage! Warnings and Precautions

The warnings, precautions, and instructions discussed in this manual cannot cover all possible conditions and situations that may occur. The operator must understand that common sense and caution are factors which cannot be built into this product, but must be supplied by the operator.

Disconnect the Blizzard Box from the vehicle battery before you connect the vehicle battery to jump starter or quick charging device.

WARNING CONTINUED:

Over-voltage can damage the electronics of the device.

- Blizzard Box can only be maintained by authorized person, improper maintenance may lead to unexpected dangers or damages.
- Corrosive materials should not be stored in Blizzard Box.
- The Blizzard Box should be used, kept and stored in a dry place, avoiding water splashes, rain, or other moisture. Do not immerse in water.
- Do not place the appliance near heat sources such as heaters or direct sunlight.
- Make sure well-ventilated for heating yield.
- The Blizzard Box is not intended for use by children.
- Children should be supervised to ensure that they do not play with the appliance.
- The appliance is only to be used with the power converter unit provided with the appliance.
- Do not turn the Blizzard Box on its side or upside down. If it is staged on its side or upside down, put the unit back to horizontal for 2 hours before operation.

WARRANTY:

Limited Warranty: PROJECT X warrants, to the original purchaser, that its products are free from defects in material and workmanship for 1 year from the date of original purchase.

Conditions of Warranty: If during the 1 year warranty period your new product is found to be defective, PROJECT X will repair such defect without charge for parts or labor, or will replace the product, subject to the following condition:

1. All repairs must be performed by PROJECT X.
2. All warranty claims must be accompanied by a copy of the sales receipt or bill of sale.
3. The equipment must not have been altered or damaged through negligence, accident, improper operation, or failure to follow the product instructions for installation, use, or care.
4. The replacement of parts is excluded from the warranty when replacement is necessary due to normal wear and tear.
5. Repair or replacement parts supplied by PROJECT X under this warranty are protected only for the unexpired portion of the original warranty.
6. This is a “repair or replace” warranty only, and does not cover the costs incurred for the installation, removal or reinstallation of the product, or damage to any mobile phone, electronic device or vehicle.

Limitations of Warranty

This limited express warranty is the exclusive warranty. Neither PROJECT X nor its third party suppliers makes any other warranty, whether express or implied. EXCEPT TO THE EXTENT PROHIBITED BY APPLICABLE LAW, ALL IMPLIED WARRANTIES (INCLUDING WARRANTIES OF MERCHANTABILITY AND FITNESS FOR A PARTICULAR PURPOSE) ARE DISCLAIMED.

Limitations of Liability and Remedy

This limited express warranty is the exclusive remedy provided by PROJECT X for a product defect. EXCEPT TO THE EXTENT PROHIBITED BY APPLICABLE LAW, PROJECT X AND ITS THIRD PARTY SUPPLIERS SHALL NOT BE LIABLE FOR ANY DIRECT, INDIRECT, SPECIAL, INCIDENTAL, OR CONSEQUENTIAL DAMAGES, WHETHER BASED ON CONTRACT, TORT, UCC, OR ANY OTHER LEGAL THEORY, EVEN IF SUCH DAMAGES ARE FORESEEABLE AND EVEN IF PROJECT X HAS BEEN ADVISED OF THE POSSIBILITY OF SUCH DAMAGES.

WARRANTY CONTINUED:

BLIZZARD BOX
MODEL#: AC57245

Responsible Party:
PROJECT X
2975 Red Hill Ave., Ste. 100, Costa Mesa, CA 92626, USA
Tel: 1-866-294-9244

FCC Compliance Statement:

This device complies with Part 15 of the FCC rules. Operation is subject to the following two conditions: (1) This device may not cause harmful interference, and (2) this device must accept any interference received, including interference that may cause undesired operation.

WARNING: Changes or modifications to this unit not expressly approved by the party responsible for compliance could void the user's authority to operate the equipment. The manufacturer is not responsible for any radio or TV interference caused by unauthorized modifications or change to this equipment. Such modifications or change could void the user's authority to operate the equipment.

NOTE: This equipment has been tested and found to comply with the limits for Class B digital device, pursuant to part 15 of the FCC Rules. These limits are designed to provide reasonable protection against harmful interference in a residential installation. This equipment generates, uses and can radiate radio frequency energy and, if not installed and used in accordance with the instructions, may cause harmful interference to radio or television reception, which can be determined by turning the equipment off and on, the user is encouraged to try to correct the interference by one or more of the following measures:

- Reorient or relocate the receiving antenna.
- Increase the separation between the equipment and the receiver.
- Connect the equipment into an outlet on a circuit different from that to which the receiver is connected.
- Consult the dealer or an experienced radio/TV technician for help.)

WARNING: This product can expose you to chemicals including DEHP and DINP, which are known to the State of California to cause cancer and birth defects or other reproductive harm.
For more information go to www.P65Warnings.ca.gov.

NOTE:

- This type of fridge has a compressor pump and it doesn't run continually. After the Blizzard box is cooled down to set temperature the pump only turns on "as needed" with 65 watt draw at 12 volts. When the Blizzard Box first starts and is cooling down it does run full time at 65W until set temperature. The Blizzard Box will then cycle on and off "as need" to hold set temperature depending on outside temperature.
- Compressor has a momentary starting surge current of 10 amp at 12 volts.
- If Blizzard Box is used with a solar panel and large car size battery a minimum of a 100w solar panel will be needed.
- The Blizzard Box is able to operate by AC adapter with 12V 10A output or 24V 4.75A output.*

The purpose of the Blizzard Box baskets is for 2 reasons.

- a) Protection from dropping goods within the aluminum cooling shell or off-road bouncing of goods inside the cooler.
- b) The basket helps to even-out the temperature within the cooler. Less cold spots and possible damaged goods. Thus use of the baskets is recommended.

TROUBLESHOOTING:

| Issue | Cause | Remedy |
|---|--|---|
| Power indicator light is not on or Blizzard Box does not work | No Power Input | Check whether input power is functional or not. The engine must be on in most vehicles to provide the power |
| | Blizzard Box fuse burnt. | Change fuse. |
| | Vehicle-mounted fuse burnt. | Refer to vehicle operating manual to change fuse. |
| | Car plug socket does not connect well | Clean the socket and check whether plug connects correctly |
| 1 Flash (Error light) | Low Voltage | Please check the source voltage to ensure it is above the voltage cut out setting |
| 2-4 Flashes (Error light) | Compressor locked or operation Speed is too low. | Unplug for 10 minutes. |
| 5 Flashes (Error light) | Ambient temperature is too high. | Ensure side ventilation vents have good air flow, and are not blocked. |

The Error codes are depicted by a number of flashes by the Error light in a sequence every four seconds. If Error indicator light blinks, the compressor will restart every 60 seconds until it starts successfully.

Have a comment or question? Email us at: info@projectxoffroad.com or visit us online at www.projectxoffroad.com

A Horizon Brands Company
 2975 Red Hill Ave, Ste. 100, Costa Mesa, CA 92626
 Copyright © 2022 ADC Offroad and Adventure, LLC. All rights reserved.



info@projectxoffroad.com

(866) 294-9244

Mon-Sat 8am-5pm PST