



SERIES X HP.70

INSTRUCTIONS & SPECIFICATIONS

Model No. AL538804 Combo



IMPORTANT SAFETY INFORMATION

- Remove negative battery cable before installation.
- Ensure lights are fitted using the appropriate wiring harness or an equivalent auxiliary wiring system.
- Ensure the lights are mounted securely to a solid surface on the vehicle.
- Cables connected to the light must not be subjected to wear or other damage.
- Do not operate device in proximity to flammable or combustible objects



info@projectxoffroad.com

(866) 294-9244

Mon-Sat 8am-5pm PST

TECHNICAL SPECIFICATIONS

Voltage: 9-33V

LEDs: 24 x 5 Watt Osram® L.E.Ds

Housing & Bracket: Pressure die-cast aluminum housing and bracket

Beam Type: Combo Beam Pattern

Lenses: Polycarbonate

Color Temperature: 5700°K

Current Draw: 8.9A at 12V per light

WIRING

Every Install is unique and we provide simple installation information but professional installation is highly recommended.

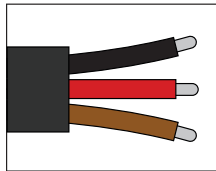

**Ground (-)
Black Wire**

**Driving Beam (+)
Red Wire**

**Positional (+)
Brown Wire**

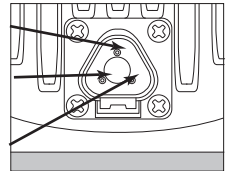

A Horizon Brands Company
2975 Red Hill Ave, Ste. 100, Costa Mesa, CA 92626
Copyright © 2021 ADC Solutions Auto, LLC. All rights reserved.

Follow manufacturer's instructions to ensure the product is properly & safely installed. The manufacturer and seller are not responsible or liable for consequential, incidental, or indirect damages, whether to person or property, resulting from the installation or improper use of this product.

- Before installing, please make sure the Driving Lights are free from damage, fracture and no impurities.
- Considering the high intensity of light, DO NOT stare at the light when it is switched on.
- The surface of the LED will reach very high temperature when it is turned on.
DO NOT touch the surface directly to avoid severe burns.
- Do not install or use product if it, in any way, impairs the safe operation of your vehicle.

▲ WARNING: This product can expose you to chemicals including DEHP and DINP, which are known to the State of California to cause cancer and birth defects or other reproductive harm. For more information go to www.P65Warnings.ca.gov.

WARRANTY

This PROJECT X product carries a Limited Lifetime warranty against defects in workmanship and materials subject to the conditions and additional warranty information available at:

www.projectxoffroad.com/pages/returns-warranty

DISCLAIMER OF WARRANTIES, INCLUDING WARRANTY OF MERCHANTABILITY AND WARRANTY OF FITNESS FOR PARTICULAR PURPOSE: EXCEPT AS SPECIFICALLY SET FORTH HEREIN, NO WARRANTY OR REPRESENTATION, EXPRESS OR IMPLIED, IS MADE AS TO THE LED CEILING LIGHT. PROJECT X AND/OR ITS AFFILIATES EXPRESSLY DISCLAIMS, WITHOUT LIMITATION, ANY STATUTORY WARRANTIES AND ALL IMPLIED WARRANTIES, INCLUDING ANY IMPLIED WARRANTY OF MERCHANTABILITY OR FITNESS FOR A PARTICULAR PURPOSE.

MOUNTING

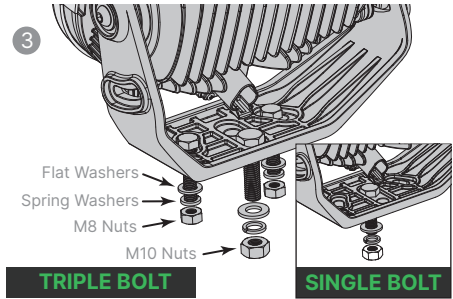
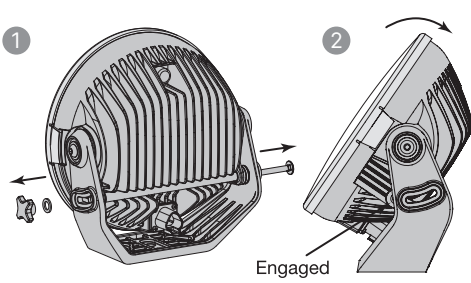

- 4 Re-assemble the Adjuster Knob, Flat Washer and Long Bolt in reverse order.
- 5 Choose a solid surface on the vehicle to mount the driving lights and secure the lamp by using flat washers, spring washers with M10 & M8 nuts.
- 5 Ensure the Adjuster Knob is done up tight.

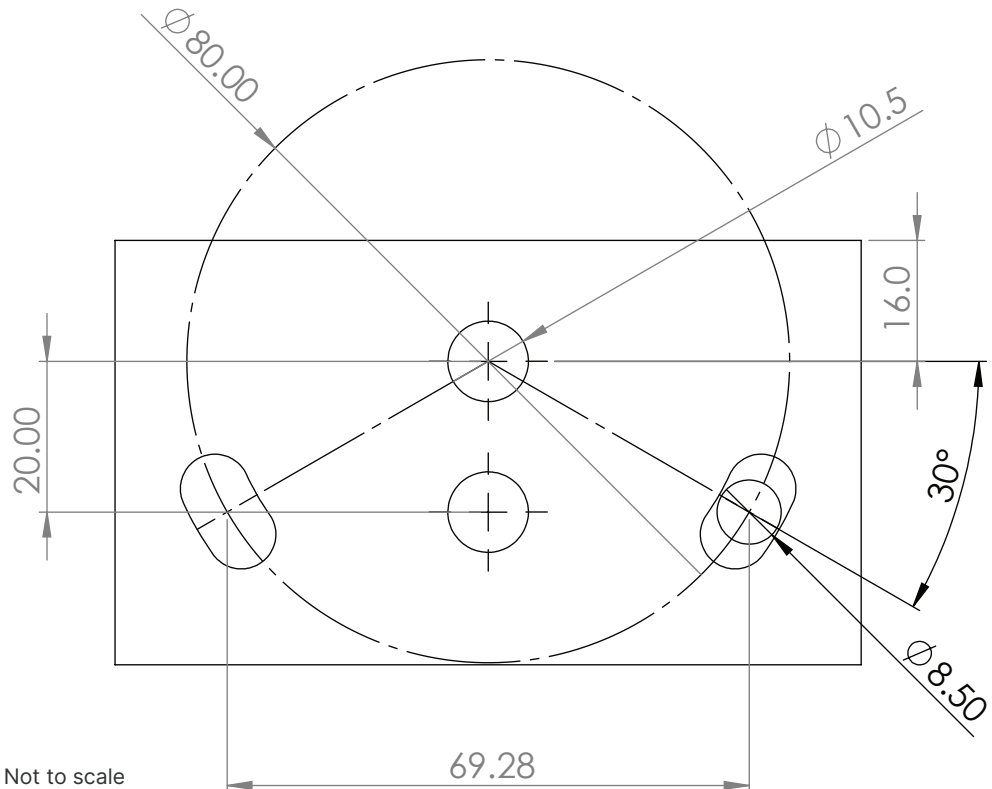

CUSTOMIZATION

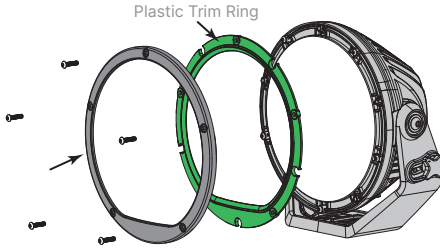

TRIM PIECE COLOR CHANGE

To change the color of the plastic trim ring, remove 5 x screws and metal bezel. Re-assemble in reverse order

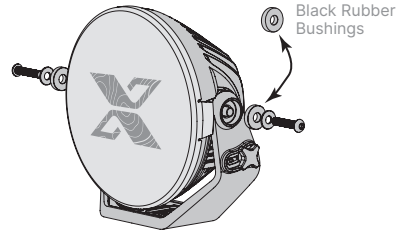

RUBBER BUSHING COLOR CHANGE

Remove the side M8 bolts, washers and blue rubber bushings. Replace with black rubber bushings. Re-assemble in reverse order.

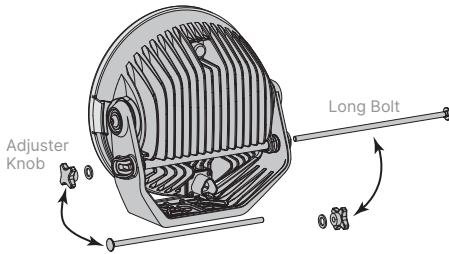

ADJUSTER KNOB

Adjuster Knob can be reversed from left hand to right hand side.

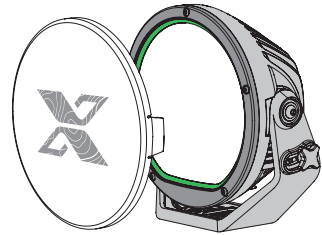

LENS COVER REMOVAL

Remove lense protector by unclipping the side wings.

COMPONENTS

Item	Description	Torque (ft/lb)
A	M6 CUSTOM CARRIAGE BOLT	-
B	M6 CUSTOM KNOB	-
C	M6 X 14 X 2mm FLAT WASHER	-
D	M8 X 25mm BHCS	3.7
E	M8 X 17 X 1.6mm FLAT WASHER	-
F	M4 X 18mm BHCS	1.5
G	M8 X 1.25 X 40mm HEX	-
H	M10 X 1.5 X 40mm HEX	-
I	M8 X 24 X 2mm FLAT WASHER	-
J	M10 X 30 X 2.5mm FLAT WASHER	-
K	M8 SPRING LOCK WASHER	-
L	M10 SPRING LOCK WASHER	-
M	M8 FLANGE NUT	11.0
N	M10 FLANGE NUT	22.0

