



**E-BIKE**

# ***User's Manual***

# TABLE OF CONTENTS

## ➤ **About this manual**

- 1. Why you should read this manual..... 1
- 2. Warning, Important safety information..... 2-4

## ➤ **Diagram**

- 1. Parts' diagram with parts name.....5-7
- 2. Wiring diagram.....8

## ➤ **Operating instruction**

- 1. Important notices..... 9-10
- 2. Riding mode.....11
- 3. Riding safely.....12.
- 4. battery charging.....13
- 5.. Checking the battery pack before first time using .....14
- 5. Inserting, removing, locking the battery.....15
- 6. Power indicator.....16
- 7. PAS (pedal assist system).....17
- 9. Throttle (if has).....18

10. Pedal installation.....	18
11. How to fold the bike(only for folding bike).....	19
12. Shiftier (if has).....	20
13.Derailleur system.....	21
14. Front wheel-quick release.....	22
15. Brake adjustment.....	23
16. Rear carrier.....	24
17.light.....	24
18.saddle position.....	25
➤ <b>Maintenance and cleaning.....</b>	<b>26-28</b>
➤ <b>FAQ.....</b>	<b>28</b>
➤ <b>Service &amp; maintenance schedule.....</b>	<b>29-33</b>
➤ <b>Problems and remedy.....</b>	<b>34-38</b>
➤ <b>About dealer and information card.....</b>	<b>39</b>

# ABOUT THIS MANUAL

## **WHY YOU SHOULD READ THIS MANUAL**

This manual is written to help you to get the best performance, comfort, enjoyment and safety when riding your new NAKTO E-bike. The manual describes specific care and maintenance procedures that help protect your warranty and ensure years of trouble free use. Please pay particular attention to the section on battery charging and maintenance.

It is important for you to understand the features and operation of your new E-bike so that you can get maximum enjoyment with maximum safety. By reading this manual before you go on your first ride, you'll know how to get the most from your new E-bike.

It is also important that your first ride on a new NAKTO E-bike be taken under a controlled environment, away from cars, obstacles and other cyclists.

## **WARNING**

*Cycling can be a hazardous activity even under the best circumstances, Giving Proper maintenance to your E-bike is your responsibility as it helps to reduce the risk of injury. This manual contains many “Warnings” and “Cautions” concerning the consequences of failure to maintain or inspect you E-bike. Many of the Warnings and Cautions say “you may lose control and fall” Because any fall can result in serious injury or even death, we do not repeat the warning of possible injury or death whenever the risk of falling is mentioned.*

## ***IMPORTANT SAFETY INFORMATION***

Your NAKTO E-Bike can provide many years of service, fun and fitness-if you take good care of it.

Understand the features of your E-Bike and become aware of the challenges that you will meet on the road. There are many things you can do to protect yourself while riding. We will offer many recommendations and safety tips throughout this manual. The following are those we believe the most important.

### ***Always Wear A Helmet!***

Helmets significantly reduce the possibility and severity of head injuries. Always wear a helmet that complies with your state laws when riding the E-Bike.

Check with your local police department for requirements in your community.

Do not wear loose clothing that can become tangled in the moving parts of the E-Bike. Wear sturdy shoes and eye protection. Also check your state laws concerning other protective wear that may be required when riding the E-Bike.

### ***Know your E-Bike!***

Your new E-Bike incorporates many features and functions that have never been built into a bicycle before. Read this manual thoroughly to understand how those features enhance your riding pleasure and safety.

### ***Ride Defensively!***

One of the most common cycling accidents is that when the driver of a parked car opens his door into a rider's path.

Another common occurrence is when a car or another cyclist moves suddenly into your path. Always be aware of other vehicles around you. Do not assume that the driver or the other cyclist see you. Get prepared to take evasive action or stop suddenly.

### ***Make Yourself Easy To See!***

Make yourself more visible by wearing bright reflective clothing. Keep your reflectors clean and properly aligned. Signal your intentions so that drivers and other cyclists can notice your actions.

### ***Ride Within Your Limits!***

Take it slow until you are familiar with conditions that you encounter. Be especially careful in wet conditions as traction can be greatly reduced and brakes less effective. Never ride faster than conditions warrant or beyond your riding abilities. Remember that alcohol, drugs, fatigue and inattention can significantly reduce your ability to make good judgments and ride safely.

### ***Keep Your E-Bikes In Safe Condition***

Follow the inspection and maintenance guidelines beginning on page\_\_\_. Check critical safety equipment before each and every ride.

### ***Know The Law***

Cyclists are required to follow the traffic rules. Additionally, some communities regulate the use of motorized bicycles

regarding minimum age requirements and necessary equipment. Check with your local police department for specific details.

### ***Correct Frame Size***

When selecting a new bicycle, the proper frame size is a very important safety consideration. Most full sized bicycles come in a range of frame sizes. These sizes usually refer to the distance between the center of the bottom bracket and the top of the frame seat tube.

**For safe and comfortable riding there should be clearance of no less than 1-2 inches between the groin area of the intended rider and the top tube of the bicycle frame, while the rider straddles the bicycle with both feet flat on the ground.**

The ideal clearance will vary between types of bicycles and rider preference. This makes straddling the frame when off the seat easier and safer in situations such as sudden traffic stops. Women can use a men's style bicycle to determine the correct size of women's model.

## Parts Diagram of Folding E-Bicycle

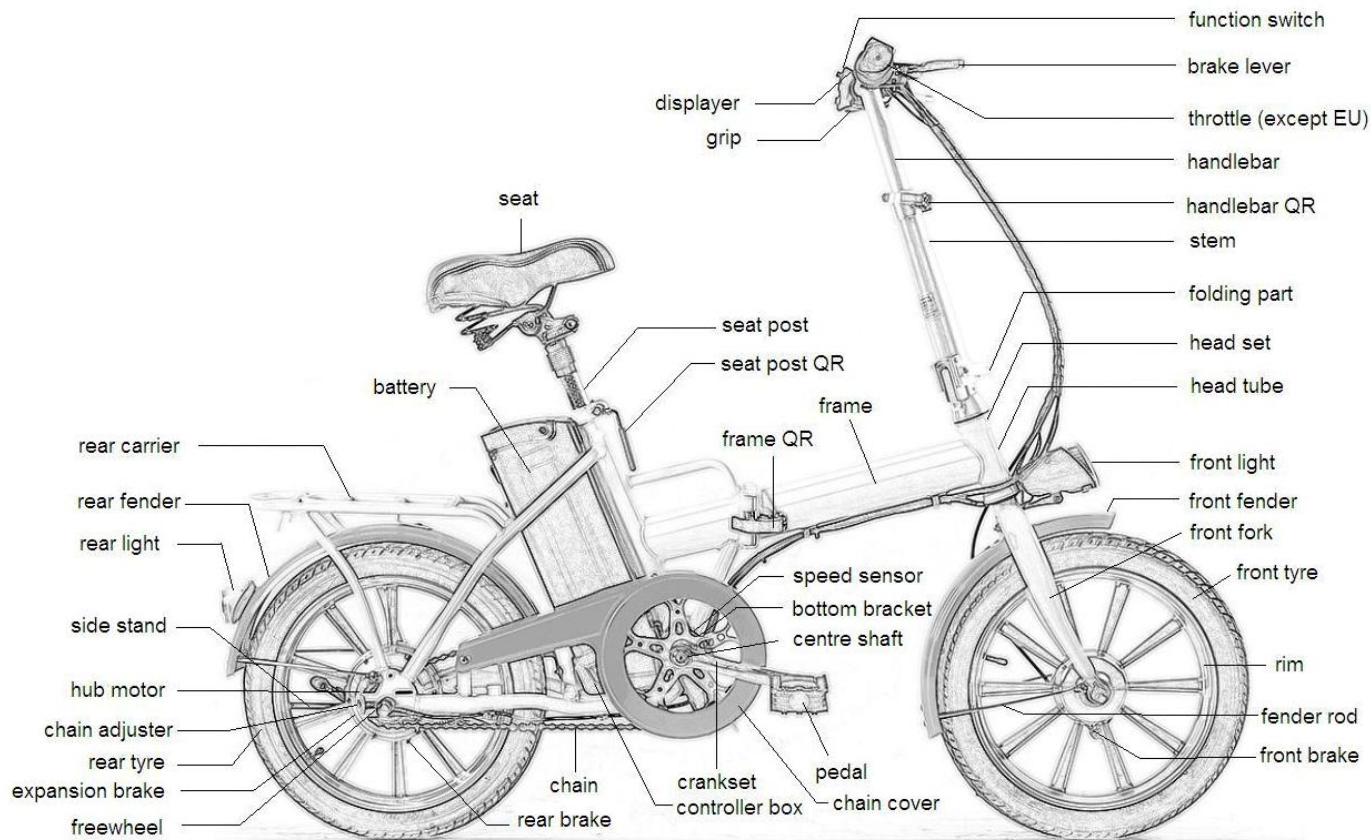



## Parts Diagram of City E-Bicycle

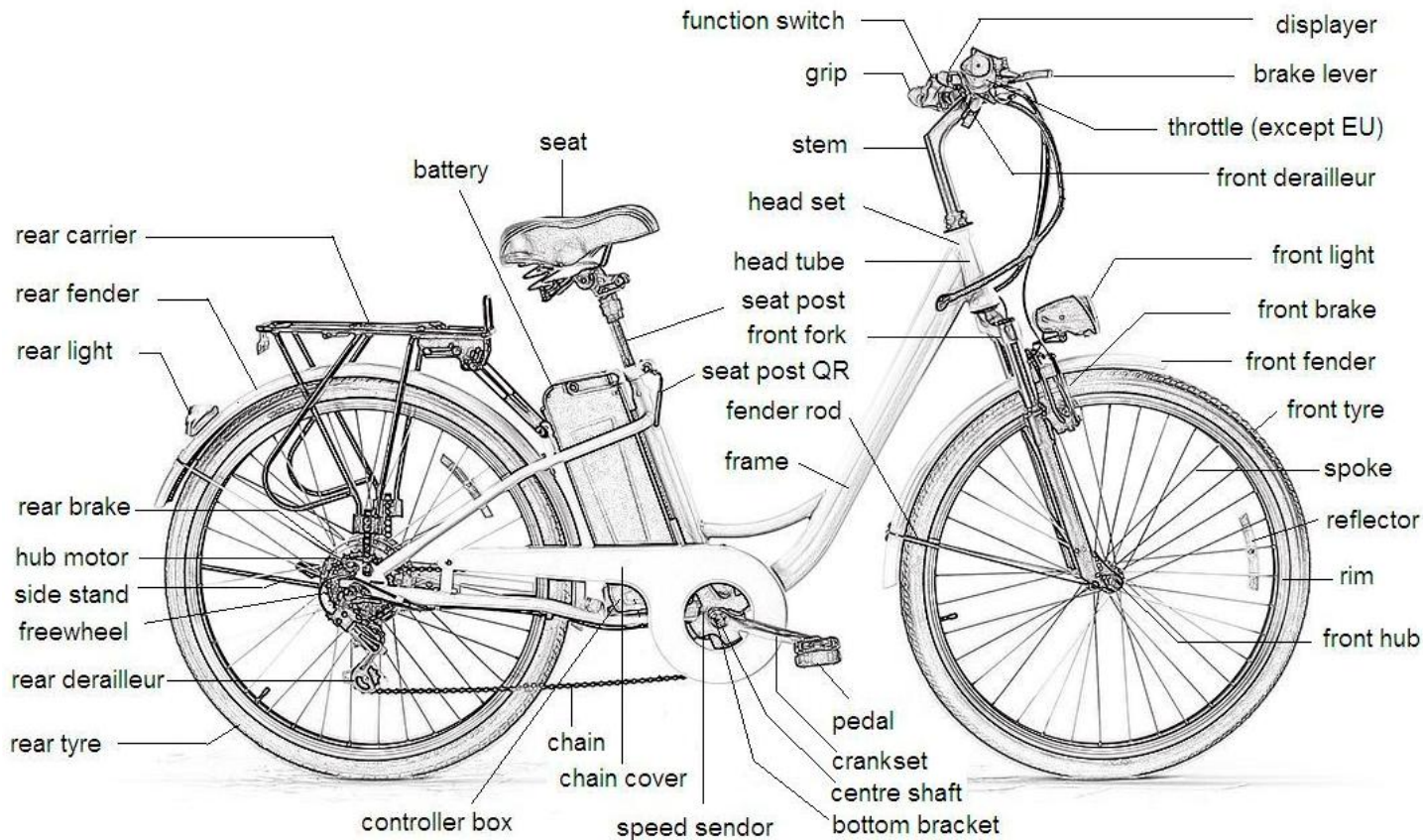

## Parts Diagram of Mountain E-Bicycle

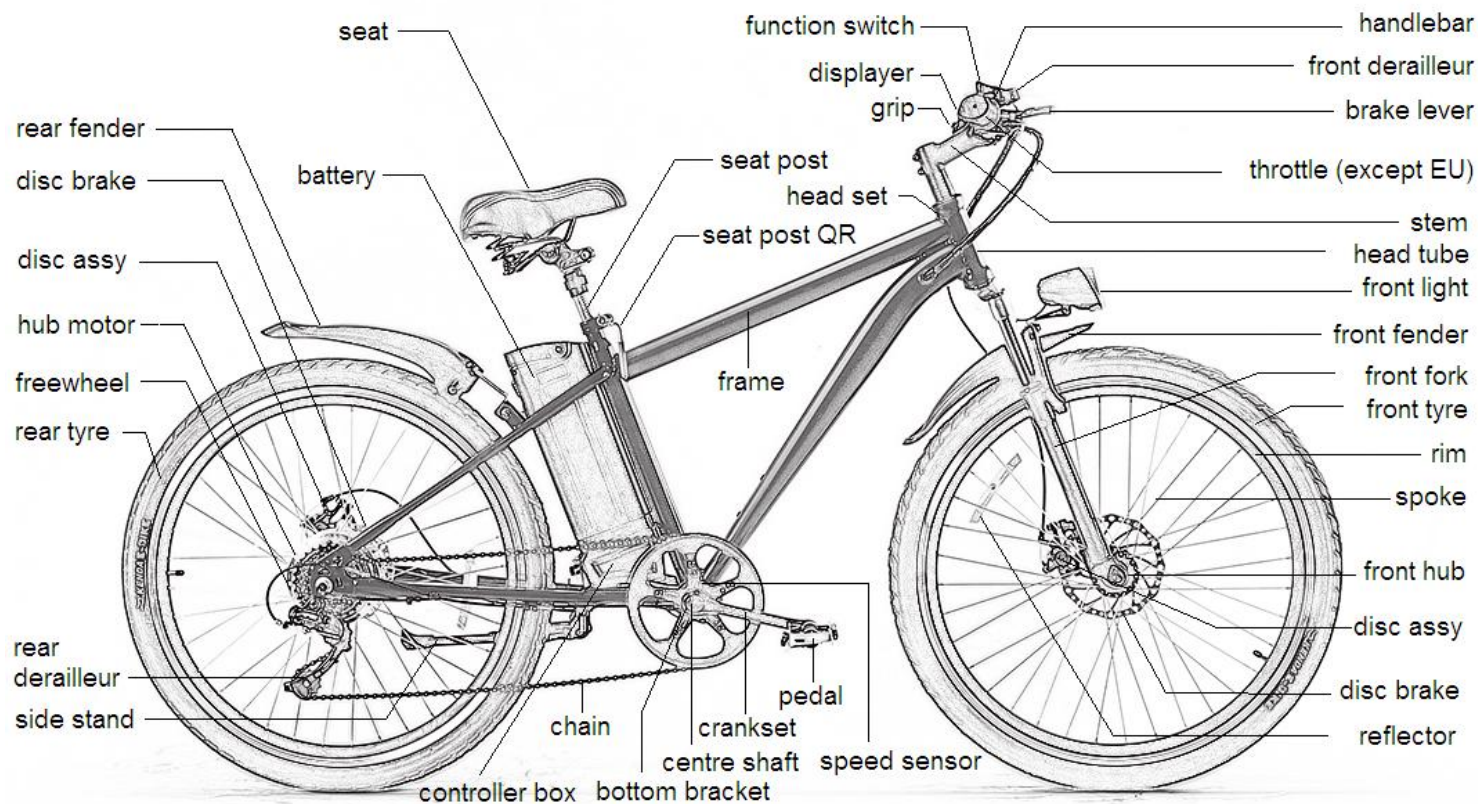



# Operation Instruction

Please read and understand these instructions completely before operating your Nakto E-bike to prevent serious injury to yourself and others, and to prevent damage to the bike also.

## ***IMPORTANT NOTICES***

- **Always recharge the battery immediately after each use. Failure to do so may damage the battery.**
- **The charger can remain plug-in for trickle-charge purpose during long periods of storage.**
- **For storage periods over 1 month, the battery should be checked and fully recharged before riding.**

## ***Helmets***

**Always wear a properly fitted helmet which covers the forehead when riding a bicycle.**

**Many states require specific safety devices. It's your responsibility to familiarize yourself with the laws of the state where you ride and to comply with all applicable laws, including properly equipping yourself and your bike as the law requires.**

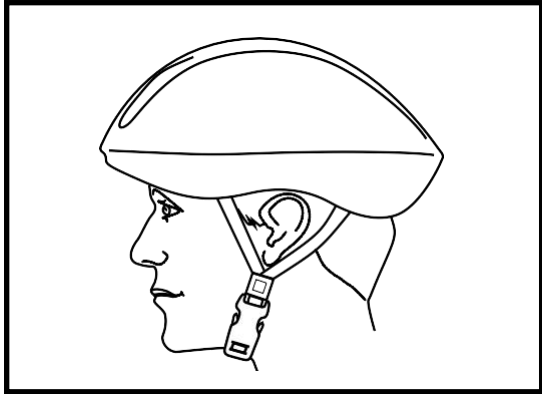

It's strongly advised that a properly fitting.

Bicycle safety helmet be worn at all times when riding your bicycle.

The correct helmet should:

- Be comfortable
- Be lightweight
- Have good ventilation
- Fit correctly
- Cover forehead

## **Reflectors**

Reflectors are important safety devices which are designed as an integral part of your bicycle. Federal regulations require every bicycle to be equipped with front, rear wheels and pedal reflectors. These reflectors are designed to pick up and reflect street lights and car lights in a way that helps you to be seen and recognized as a moving bicyclist. Checking reflectors and their mounting brackets regularly to make sure they are clean, straight, unbroken and securely mounted. Replace damaged reflectors and straighten or tighten any that are bent or loose.

Your bicycle is supplied with one front, one rear wheel reflectors, and four pedal reflector. These are important safety and legal requirements, and should remain securely fitted and in good, clean condition at all times. Periodically inspect all reflectors, brackets and mounting hardware for signs of wear or damage. Replace immediately if damage is found. Some bicycles will require you to install your reflectors onto your bicycle. Please refer to the following section for instructions on all the types of bicycle reflectors.

## ***Riding method***

Be familiar with all the spare parts of the e-bike and test all the electric functions before riding. Make sure all the spare parts for the bicycle in good condition. the power for battery, and the pressure for tyres. The detail operation as following:

### **The way for start-up**

Insert the key into power switch at the right side of battery box, turn to “ON” status, the power display light on, it means power supply is normal.

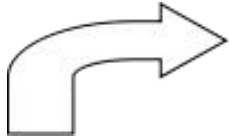

1.Start-up by accelerator: turn the accelerator from outside to inside (anticlockwise), and the rotation angle should be from small to large for starting, then you can adjust speed by turning the accelerator slowly, the speed can increase to 20km/hour, but the actual speed depends on the weight, the road,tire pressure and other factors.

2.Start-up by pedal assist:After turning on power,you can also step the pedal until one and half cycles to start-up the e bike,then you can control speed for bicycle by speed for bicycle by the speed of stepping,if you step faster the speed for bicycle faster too, but please do not step too hard,in case for damaging the components of e bike.



## ***RIDING SAFELY***

### **Riding attention on the road**

- 1, The speed should be increased slowly after start-up, in case of wasting energy and damage electrical components, it is much better for start-up with pedal assist.
- 2, Please riding with the pedal assist when climbing, in order to prolong the service life of battery and the motor.
  1. In guarantee under the premise of safety, try to reduce frequent braking and start-up while riding, in order to save energy.
  2. To stop the e-bike, you can release the accelerator by turning clockwise, the speed will slow down and stop.
  3. Do not tighten the accelerator and brake together while riding, you can release the accelerator first, and then brake. In case motor overload and damage the other components for the e-bike.
  4. The local standard weight is 75kg (include the rider weight), please do not overload.
  5. Moreover, a rear brake system has been installed to the e-bike, it will automatically cut off power supply to the motor and slow down when you pull the brake, then the rear brake in the back tyre stops the e-bike.

### **Parking attention**

- 1, Shut off the power switch after you get off, in order to prevent accident by turning accelerator without attention and start-up the bicycle abruptly.
2. Do not start-up bicycle frequently while resting, to ensure the service life for battery, motor and electric switch.
3. Shut off the power after parking, and remove the key.

## ***Battery charging***

When the ride is over or the battery is running out, charging battery immediately.

Charging methods can be divided into two kinds:

One is to take off the battery charge, another is charging on e bikes directly.

Attach the charger connector to the bike and the AC connector to a 100-220V/50-60Hz power source.

There is an LED indicator on the battery charger unit.

The LED is red when the power is connected and the battery is charging.

When the LED turns green, it means the battery is full.

SLA(sealed lead acid)recommended charge time:6-8hours

Li-LON recommended charge time:5-6 hours

Do not charge continuously for more than 18 hours at any one time.

After charging, unplug the input socket first (from the outlet), then unplug the output socket (from the bike).

The battery charger must have constant voltage. Fluctuating voltage or fluctuating power supply of any kind may damage the battery storage cells.





## Checking the battery Pack before using for the first time



- The battery pack is applied partially charged. To ensure fully battery pack capacity, completely charge the battery pack before using for the first time.
- The distributor should charge the batteries as soon as receiving the e bike from supplier.

### Battery Care

- Even with proper care, rechargeable batteries do not last forever. Every time the battery is discharged and subsequently recharged. Its relative capacity decreases by a small percentage. You can maximize the life of your battery by following the instructions in this guide. Battery should be fully charged immediately when they are received for the full recommended charge times

**SLA(sealed lead acid)recommended charge time:6-8hours**

**Li-LON recommended charge time:5-6 hours**

- For a complete, 100% charge, leaving the battery on the charger for one full hour after the charger indicator light turn green.
- Never charge batteries for longer than 24 hours.
- Li-ion batteries do not have a “memory.” Partial discharge/charge cycles will not harm the batteries’ capacity or performance.
- The rated output capacity of a battery is measured at 77°F(25°C).Any variation in this temperature will alter the performance of the battery, and shorten its expected life. High temperatures especially reduce overall battery life &run time.
- Always be sure to turn the bike power switch to “OFF” after each use. If you leave the power switch in the “ON” position, or your product has not been charged for a long period of time, the battery may reach a stage at which they will no longer hold a charge

## Inserting, unlocking and removing the battery

- Insert the key into the keyhole
- Turn the key switch to ON when using the e bike(C.picture1)
- Turn the key switch to OFF when stopping using the e bike(B. picture)
- Turn the key switch to (A.picture1),then the battery is unlock and removable

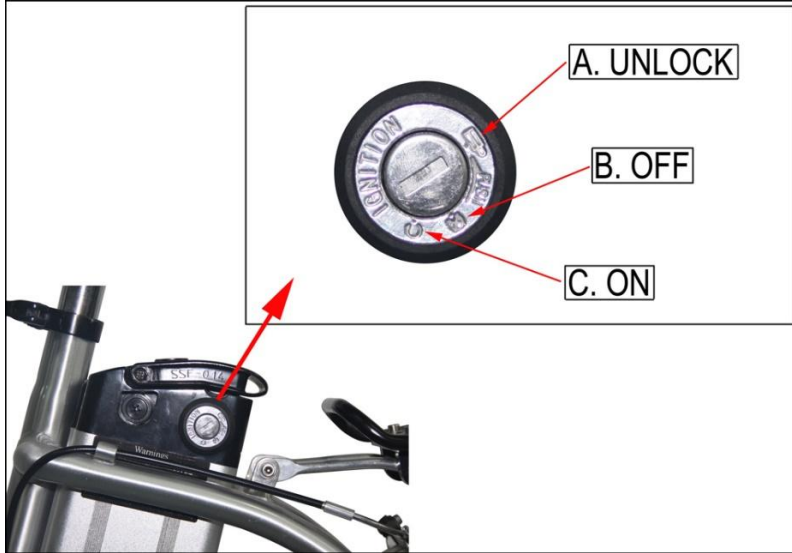

Picture 1

## ***Power indicator***

When the throttle or sensor is engaged (Powering the motor) and the bicycle is in motion, the LED on the battery gauge (on the throttle or separately unit) indicate instantaneous line voltage as measured at the battery terminals - not the available energy in the battery pack.

The line voltage will wing out from a dead stop, or going up a steep hill, the motor will be under a high load and may show a reduced number of LED or show the “Yellow” or even “RED” LED.

When the throttle is disengaged (i.e. no power to the motor due to the bicycle being Stationary or coasting) LED on the throttle will indicate the voltage of the battery pack. The voltage of the battery pack will rise when no load is on the motor. The best indication of how much battery life is remaining is to check the throttle LED, after reaching cruising speed, on a flat straight road as this will allow the battery voltage to stabilize and give a much more accurate reading.



# PAS+1

**PEDAL ASSIST SYSTEM**

The bikes have an electric pedal assisted driving system. In EU countries, it is known legally as “PAS” cycle or Pedal Assisted System.

The driving assisted system consists of a driving unit, a battery, a controller, and various electronic components (harness wires, sensors and switches). It is important to know that when the assistant system is turned on, the driving unit engages to provide power only while you are pedaling. The amount of power provided by the drive unit depends on your pedaling force and the assistance model/level you set with handlebar control unit at any time, if you stop pedaling, the drive assistant will disengage. In all models/levels, the driving assisted system power reduces progressively and cuts off as the bike reaches a speed of 25km/h,(15.5mph), or sooner if you stop pedaling. The drive assist re-engages when speed drops below 25km/h, (15.5mph) as long as the pedals are turning.



If the e-bike is equipped with multi-function display (see photo at left.), Which has 3 levels of PAS speed, and power indicator on and and light on/off..

Keep pressing '-' button to turn off PAS, you can pedal the bike normally. The drive system is not activated.

Hold the '+' button on meter can get higher PAS speed level. Each level of assist corresponds to a maximum motor speed; at level 3, the motor runs at full power.

Overall range decrease at higher power levels.

## ***Throttles (If has)***

Throttles are equipped on some models of electric bicycles. Throttles operate by rotating the throttle towards the rider much like a motorcycle.

They generally are the inner half of the right side handlebar grip and

May also contain a battery gauge.

The more you twist the throttle, the faster the motor system will propel the bicycle.



## ***Pedal installation***

Pedals are a pair with “R” & “L” (picture 1), “R” for right, “L” for left. Tight the pedals with the directive turnings (picture 2).



Picture 1

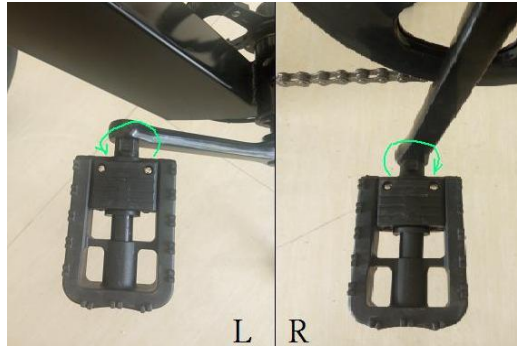

Picture 2

## ***How to fold the bike (Only for folding bike)***

1. Turn the key switch to OFF.
2. Unlock the handlebar quick release lever (A, Picture 1) and push Down the handlebar to the lowest position, then lock the handlebar Quick release lever.
3. Unlock the handlebar quick release lever (A, Picture 2) and rollover The handle bar.
4. Rotate the pedal upward so it is perpendicular to the ground (A, Picture 3).
5. Release the lock lever from its clasp on the right side of the E-Bike (A, Picture 4).
6. Rotate the lock lever (A, Picture 4) clockwise until it points backward Pull the locknut and rotate the lock nut (A, Picture 4) out away from the E-Bike until the nut clears the lock plate (B, Picture 4).
7. Grasp the seat and the handlebar. Pivot the front half of the frame Rearward around the hinge until the front wheel is beside the rear wheel (Picture 5).

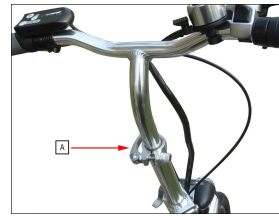

Picture 1

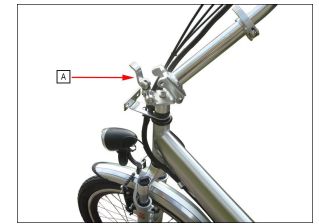

Picture 2

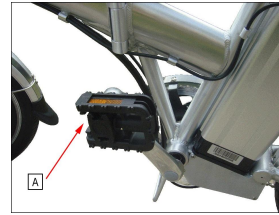

Picture 3

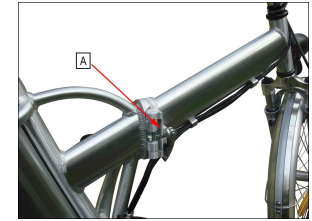

Picture 4

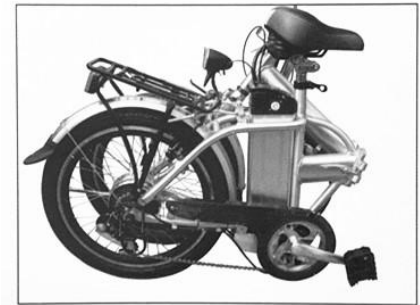

Picture 5

## **Shifter ( If has)**

Some of NAKTO E-Bike go with gears, which consists of:

- A rear sprocket cluster, called a freewheel or cog set
- A rear derailleur
- One swifter
- One control cable
- One front sprocket called a chaining
- A drive chain

There are many different types of swifter mechanisms, each preferred for specific

Applications because of its ergonomic, performance and price characteristics.

A downshift is a shift to a lower or lower gear, one which is easier to pedal. An upshift is a shift to a higher or faster gear, one which is harder to pedal. For example, you can downshift to a lower gear to make pedaling easier on a hill.

On the other hand, you may upshift to a higher gear when you wish to go faster.

Whether up-shifting or downshifting, the derailleur system requires that the drive

Chain be moving forward and be under at least some tension. A derailleur will

Shift only if you are pedaling forward.

### **Caution:**

Never move the swifter while pedaling backward. Also do not pedal backwards after moving the swifter. Either of these actions could jam chain and cause serious damage to the E-Bikes.

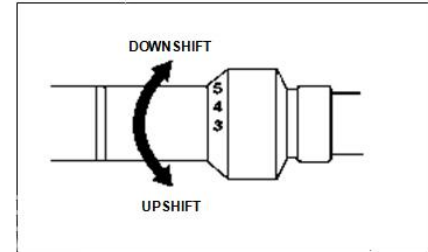

## ***Derailleur System***

The derailleur system includes the front and rear derailleur, the shift levers, and the derailleur control cables, all of which must function properly for smooth gear shifting to occur.

### **Derailleur**

Although the front and rear derailleur are initially adjusted in our factory, you will need to inspect and read just both before riding bicycle.

### **Rear Derailleur**

Begin by shifting the rear swifter to largest number indicated, loosen the cable from the rear derailleur cable anchor bolt, and place the chain on the smallest sprocket.

Adjust the high limit screw so that the guide pulley and the smallest sprocket are lined up vertically. Re-tighten the cable, pull out any slack, and re-tighten the anchor bolt securely. Shifting through the gears, making sure that each gear is achieved quietly and without hesitation. If necessary, use the barrel adjuster to fine tune the cable tension by turning it the direction you want the chain to go. For example, turning clockwise will loose the cable tension and move the chain away from the wheel, while turning counter-clockwise will tighten cable tension and direct the chain to the wheel.

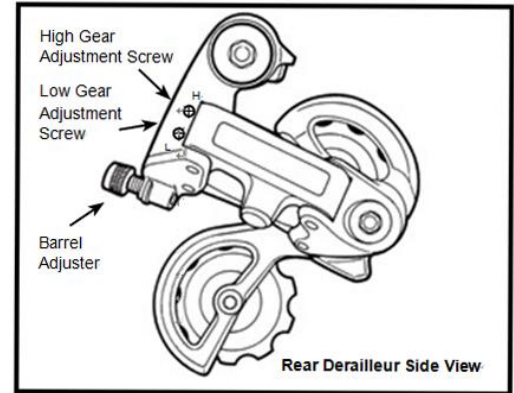
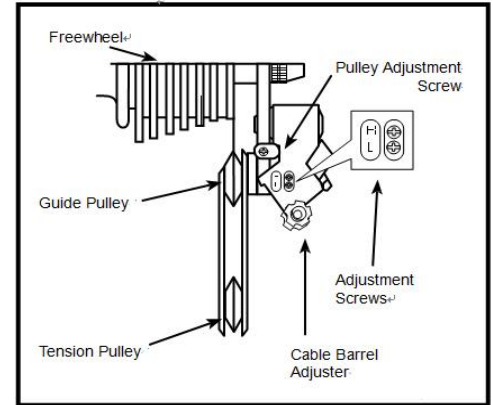



## Front Wheel

### Installing

1. Make sure the brakes are loose enough to allow the wheel to pass through the brake pads easily.
2. Place wheel into fork dropouts.
3. Install retaining washers with raised lip pointed towards the fork, and insert into the small hole of the fork blade.  
NOTE: Some bikes may have step retaining washers in place of the retaining washer. If so install the step retaining washer, raised portion sliding into the fork dropouts.
4. Install axle nut and tighten. Make sure the wheel is centered between the fork blades.
5. Spain the wheel to make sure that it is centered and clears the brake shoes. Tighten the brakes if necessary.

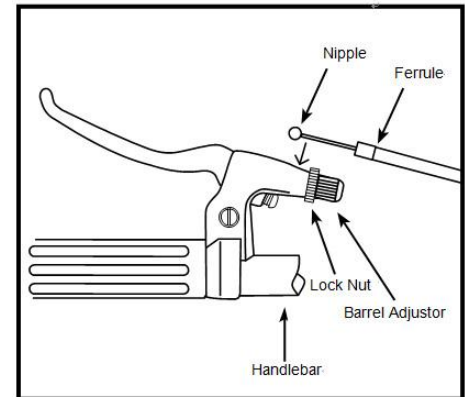
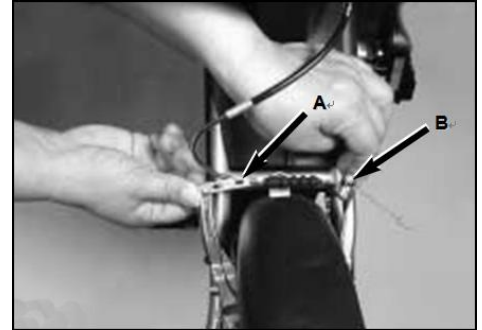

## ***Brakes***

If there is some noise of the rear brake ,then you can adjust this screw.



This screw can adjust the loose and tight of the rear brake.



## ***Rear Carrier***

**Installing the rear carrier onto the rear wheel, and make sure the screws are firmly fixed.**



## ***Light***

**Insert the screw and tighten it.**



## ***Saddle position***

Correct saddle adjustable is an important factor to get the best performance and comfort from your E-Bike.

If you find the saddle position is not comfortable, there are two adjustments.

### **A: Up and down adjustment.**

Your leg length determines the correct saddle height.

The saddle is at the correct height if you can just reach the “down” pedal with one heel when you are seated on the saddle and the crank arms are parallel to the seat tube. To check for correct saddle height, perform the following:

1. Sit on the saddle, and place one heel on a pedal.
2. Rotate the crank until the pedal with your heel on it is in the down position and the crank arm is parallel to the seat tube. Your leg should be completely straight and just touching the center of the pedal. If this is not the case, your saddle height needs to be adjusted.

### **B:Saddle tilt adjustment**

Most people prefer a horizontal saddle; but some riders prefer to have the saddle nose tilted slightly up or down. You can adjust saddle tilt by loosening the saddle quick release, tilting the saddle to the desired position, and retightening the saddle quick release. Tight enough so that you cannot move or jiggle the saddle. Very small changes in saddle position can have a substantial effect upon performance and comfort. Consequently, whenever you make a change to your saddle position, make only one directional change at a time, and make the changes in small increments until you have found the position at which you are most comfortable.



# MAINTENANCE AND CLEANING

**NOTE:** 

---

*Technological advances have made the NAKTO E-Bike and the components more complex than ever before. And the pace of innovation is increasing. This on-going evolution makes it impossible for this manual to provide all the information required to properly repair and/or maintain your E-Bike. In order to help minimize the chances of an accident and possible injury, it is critical that you have any repair or maintenance performed by your dealer which is not specifically described in this manual.*

---

*Equally important is that your individual maintenance requirements will be determined by everything from your riding style to geographic location. Consult your dealer for help in determining your maintenance requirements. How much of your NAKTO E-Bike service and maintenance you can do yourself depends upon your level of skill, experience, and special tool availability.*

**WARNING:**

Many NAKTO E-Bike service and repair tasks require special knowledge and tools. Do not begin any adjustments or service on your NAKTO E-Bike if you have the slightest doubt about your ability to properly complete them. Improper adjustment or service may result in damage to the NAKTO E-Bike or in an accident which can cause serious injury or death.

---

**INSPECTION AND MAINTENANCE**

For your safety and enjoyment and to insure a long life for your NAKTO E-Bike, inspect and maintain your E-Bike regularly. Use the table below for guidance. It is very important that you check certain systems and components before each and every ride. The proper condition and function of these systems is critically important for your safety.

Component or Condition	Inspect before Every ride	Inspect periodically *	Clean and/or lubricate	Adjust / Tighten	Repair/Replace If necessary
Tire pressure (60-65 psi)	✓			✓	
Tire wear / damage	✓			✓	
Brake pad adjustment	✓			✓	
Handlebar quick release adjustment	✓				✓
Controls and displays	✓				
Seat post quick release adjustment	✓			✓	
Brake pad wear		✓			✓
Brake cable tension/wear		✓		✓	✓
Spoke tension		✓		✓	
Wheel true		✓		✓	
Hub bearings		✓	✓	✓	
Chain lubrication		✓	✓		
Derailleur adjustment		✓	✓	✓	
Reflectors		✓			✓
Battery and charger		✓			✓
Headset		✓	✓	✓	
Bottom bracket		✓	✓	✓	
All bolts,nuts,and mounting hardware				✓	✓

*\* Every 5 to 10 rides depending on length and conditions of the ride*

## ***Battery Storage***

### **When storing your batteries for a long period of time:**

- Charge your batteries every 30 days to avoid capacity loss. Batteries slowly self-discharge when left unused for a long period of time; if the battery cells are allowed to reach a critically low voltage, their lifespan and capacity will be permanently reduced.
- Always disconnect your charge from the wall outlet and battery before storing the battery.
- Avoid storing your batteries in extreme temperatures, whether hot or cold.
- Batteries are best kept in a cool, dry place. Do not allow batteries to accumulate condensation, as this could cause shorting or corrosion.
- The recommended storage temperature for both SLA and LI-ion batteries is between 32-77 ° F (0-25 ° C).
- Avoid exposing the battery to extreme heat (104° F or higher) for long periods of time.

## **FAQ**

### **P: Is it normal that the batteries get warm when recharging?**

R: Yes, it is normal that the batteries will become warm to the touch during the recharging process. This is because the increase of internal resistance and less energy conversion efficiency from electric energy to chemical energy.

### **P: How long will my batteries last before needing replacement?**

R: Average battery life depends on use and conditions. Even with proper care, rechargeable batteries do not last forever. Conservatively, an SLA battery will come to the end of its useful after ~350 full discharge/charge cycles, while Li-ion batteries will last more than 800 cycles. A partial charge/discharge counts fractionally against those numbers; running the battery down halfway then recharging it completely uses up one half of a charge cycle.

“End of useful life” refers to the point at which a battery can no longer supply 60% of its original rated capacity in ampere-hours. After this point, the aging process will accelerate and the battery will need to be replaced.

## ***SERVICE & MAINTENANCE SCHEDULE***

Some service and maintenance can and should be performed by the owner, and require no special tools or knowledge beyond what is presented in this manual.

The following are examples of the type of service you should perform yourself. All other service, maintenance and repair should be performed in a properly equipped facility by a qualified NAKTO E-Bike mechanic using the correct tools and procedures specified by the manufacturer.

### ***Break-in Period***

Your E-Bike will last longer and work better if you break it in before riding it hard. Control cables and wheel spokes may stretch or sear when a new E-Bike is first used and may require readjustment by your dealer. Your mechanical safety check will help you identify some things that need readjustment. But even if everything seems fine to you, it is best to take your E-Bike back to the dealer for a checkup. Dealers typically suggest you bring the E-Bike in 30 days for a checkup. Another way to judge when it's time for the first checkup is to bring the E-Bike in after 10 to 15 hours of use. But if you think something is wrong with the NAKTO E-Bike, ask it to your dealer before riding it again.

### ***Before every ride:***

- Perform the mechanical safety

### ***After every long or hard ride; if the E-Bike has been exposed to water or grit; or at least every 100 miles:***

- Clean the E-Bike
- Lightly oil the chain, freewheel cogs and rear derailleur pulley bushings. Wipe off excess oil. Lubrication is a function of climate. Talk to your dealer about the best lubricants and the recommended lubrication frequency for your area



**After every long or hard ride or after every 10 to 20 hours of riding:**

- Squeeze the front brake and rock the NAKTO E-Bike forward and back. Does everything feel solid? If you feel a clunk with each forward or backward movement of the E-Bike, you probably have a loose headset. Have your dealer check it.
- Lift the front wheel off the ground and swing it from side. Feel smooth? If you feel any binding or roughness in the steering, you may have a tight headset. Have your dealer check it.
- Make sure all bolts, nuts and mounting hardware are tight.

**CAYTION:**

Since the right pedal on your NAKTO E-Bike folds up, grasp the crank arm when performing this check on the right side.

**WARNING:**

*Like any mechanical device, an E-Bike and its components are subject to wear and stress. Different materials and mechanisms wear at different rates and have different life cycles .If a component's life cycle is exceeded, the component can suddenly and catastrophically fail, causing serious injury or death to the rider. Scratches, cracks ,fraying and discoloration are signs of stress-caused fatigue and indicate that a part is at the end of its useful life and should be replaced.*

**Flat Tire**

*If you get a flat tire, remove the wheel. Depress the tire valve to let all the air out of the tube. Remove one bead of the tire from the rim by grasping the tire at a point opposite the valve stem with both hands lifting and peeling one side of the tire off the rim. If the bead is on too tight for you to unseat it with your hands, use tire levers to lift the bead carefully over*

*the tire rim. Push the valve stem through the wheel rim. Remove the inner tube.*

*Carefully check the outside and inside of the tire for the cause of the puncture and remove the cause if it is still here. If the tire is cut, line the inside of the tire in the area of the cut with something handy-tape, a spare patch, a piece of inner tube, a dollar bill-whatever will keep the cut from pinching the inner tube.*

*Either patch the tube (Follow the instructions in your patch kit), or use a new tube. Reinstall the tire and tube. Slip one tire bead over the rim. Insert the tube valve through its hole in the rim .Feed the tube carefully into the cavity of the tire. Inflate the tube just enough to give it some shape. Starting at the valve stem use your thumbs to seat the tire bead inside the rim. Work your way around both side of the wheel until the entire bead is seated in the rim. Be careful not to pinch the tube between the tire bead and the wheel rim. If you have trouble getting the last few inched of bead over the edge of the rim with thumb pressure, use a tire lever and be careful not to pinch the tube.*

**CAUTION:**

*If you use a screwdriver or any tool other than a tire lever, you are likely to puncture the tube.*

*Check to make sure the tire is evenly seated around both sides of the rim and that the tube is inside the tire beads. Push the valve stem into the tire to make sure that its base is seated within the tire's beads. Inflate the tube slowly to the recommended pressure, all the while checking to make sure that the tire beads stay seated in the rim. Replace the valve cap, and install the wheel onto the E-Bike.*

**WARNING:**

*Riding your E-Bike with a flat or under-inflated tire can damage the tire, tube and E-Bike, and can cause you to lose control and fall.*

**Broken Spoke:**

*A wheel with a loose or broken spoke is much weaker than a fully tensioned wheel.*

*If you break a spoke while on a ride, you will have to ride home much more lowly and carefully because the weakened wheel could break additional spokes and become useless.*

**WARNING:**

*A broken spoke seriously weakens the wheel and may cause it to wobble, striking the brakes or the frame. Riding with a broken spoke can **cause you to lose control and fall.***

*Twist the broken spoke around the spoke next to it keep it from flopping around and getting caught between the wheel and the frame. Spin the wheel to see if the rim clears the brake pads. If the wheel will not turn because it is rubbing against a brake pad, try turning the brake cable adjusting barrel(s) clockwise to slacken the cable and open up the brakes .If the wheel still won't turn, open the brake's quick release and secure any loose as best you can. Walk the NAKTO E-Bike ,or if you must, ride it with extreme caution, because you now have only one working brake.*

**Basic Maintenance**

*The following procedures will help you maintain your hybrid electric bicycle for years of enjoyable riding.*

*Properly maintain the batteries by keeping them fully charged when not in use.*

*Do not ride your electric bicycle in the water(damp roads, puddles ,rain, streams, etc.) and never immerse it in water as the electrical system may be damaged.*

*Periodically check the wiring and connectors to ensure there is no damage and the connectors have good continuity.*

*For painted frames ,dust the surface and remove any loose dirt with a dry cloth. Clean and wipe with a damp cloth soaked in a mild detergent mixture. Dry with a cloth and polish with car or furniture wax. Use soap and water to clean plastic parts and robber tires. Chrome plated bikes should be wiped over with a rust preventative fluid.*

*Store your bicycle under shelter. Avoid leaving it in the rain or being exposed to corrosive materials.*

*Riding on the beach or in coastal areas exposes you bicycle to salt which is very corrosive. Wash your bicycle frequently and wipe or spray all unpainted parts with an anti-rust treatment .Make sure wheel rims are dry so braking performance is not affected. After rain, dry you bicycle and apply anti-rust treatment.*

*If the hub and bottom bracket bearings of your bicycle have been submerged in water, they should be taken out and re-greased. This will prevent accelerated bearing deterioration.*

*If paint has become scratched or chipped to the metal, use touch up paint to prevent rust. Clear nail polish can also be used as a preventative measure.*

*Regularly clean and lubricate all moving parts ,tighten components and make adjustments as required.*

## **Storage**

Keep your bicycle in a dry location which is away from the weather and sun.

Direct sunlight may cause paint to fade or rubber and plastic parts to crack. Before storing your bicycle for along period of time, clean and lubricate all components and wax the frame. Deflate the tires to half pressure and hang the bicycle off the ground. Charge your batteries and make sure they are protected from water. Batteries should be charged every 30 days to avoid capacity loss. Don't cover the bicycle with plastic as "sweating" will result and it may cause rusting. Please notice that your bicycle warranty does not cover paint damage (except as outlined in the warranty section of this manual),rust, corrosion, dry rot or theft.

## ***Problems and Remedy***

<b>Problem</b>	<b>Possible Cause</b>	<b>Remedy</b>
Gear shifts not working properly	<ul style="list-style-type: none"> <li>- Derailleur cables sticking/stretched/damaged</li> <li>- Front or rear derailleur not adjusted properly</li> <li>- Indexed shifting not adjusted properly</li> </ul>	<ul style="list-style-type: none"> <li>- Lubricate/tighten/replace cables</li> <li>- Adjust derailleurs</li> <li>- Adjust indexing</li> </ul>
Slipping chain	<ul style="list-style-type: none"> <li>- Excessively worn/chipped chain ring Or freewheel sprocket teeth</li> <li>- Chain worn. stretched</li> <li>- Stiff link in chain</li> <li>- Non-compatible chain/chain ring/ freewheel</li> </ul>	<ul style="list-style-type: none"> <li>- Replace chain ring, sprockets and chain</li> <li>- Replace chain</li> <li>- Lubricate or replace link</li> <li>- Seek advice at a bicycle shop</li> </ul>
Chain jumping off freewheel sprocket or chain ring	<ul style="list-style-type: none"> <li>- Chain ring out of true</li> <li>- Chain ring loose</li> <li>- Chain ring teeth bent or broken</li> <li>- Rear or front derailleur side-to-side Travel out of adjustment</li> </ul>	<ul style="list-style-type: none"> <li>- Re-true if possible, or replace</li> <li>- Tighten mounting bolts</li> <li>- Repair or replace chain ring/set</li> <li>- Adjust derailleur travel</li> </ul>
Constant clicking noises when pedaling	<ul style="list-style-type: none"> <li>- Stiff chain link</li> <li>- Loose pedal axle/bearings</li> <li>- Loose bottom bracket axle/bearings</li> <li>- Bent bottom bracket or pedal axle</li> <li>- Loose crankset</li> </ul>	<ul style="list-style-type: none"> <li>- Lubricate chain/Adjust chain link</li> <li>- Adjust bearings/axle nut</li> <li>- Adjust bottom bracket</li> <li>- Replace bottom bracket axle or pedals</li> <li>- Tighten crank bolts</li> </ul>

<b>Problem</b>	<b>Possible Cause</b>	<b>Remedy</b>
Grinding noise when pedaling	<ul style="list-style-type: none"> <li>- Pedal bearings too tight</li> <li>- Bottom bracket bearings too tight</li> <li>- Chain fouling derailleurs</li> <li>- Derailleur jockey wheels dirt/binding</li> </ul>	<ul style="list-style-type: none"> <li>- Adjust bearings</li> <li>- Adjust bearings</li> <li>- Adjust chain line</li> <li>- Clean and lubricate jockey wheels</li> </ul>
Freewheel does not rotate	<ul style="list-style-type: none"> <li>- Freewheel internal pawl pins are jammed</li> </ul>	<ul style="list-style-type: none"> <li>- Lubricate. If problem persists, replace freewheel</li> </ul>
Brakes not working effectively	<ul style="list-style-type: none"> <li>- Brake blocks worn down</li> <li>- Brake blocks/rim greasy, wet or dirty</li> <li>- Brake cables are binding/stretched/damaged</li> <li>- Brakes levers are binding</li> <li>- Brakes out of adjustment</li> </ul>	<ul style="list-style-type: none"> <li>- Replace brake blocks</li> <li>- Clean blocks an rim</li> <li>- Clean/adjust/replace cables</li> <li>- Adjust brake levers</li> <li>- Center brakes</li> </ul>
When applying the brakes they squeal/squeak	<ul style="list-style-type: none"> <li>- Brake blocks worn down</li> <li>- Brake block toe-in incorrect</li> <li>- Brake blocks/rim dirty or wet</li> <li>- Brake arms loose</li> </ul>	<ul style="list-style-type: none"> <li>- Replace blocks</li> <li>- Correct block toe-in</li> <li>- Clean blocks and rim</li> <li>- Tighten mounting bolts</li> </ul>
Knocking or shuddering when Applying brakes	<ul style="list-style-type: none"> <li>- Bulge in the rim or rim out of true</li> <li>- Brake mounting bolts loose</li> <li>- Brakes out of adjustment</li> <li>- Fork loose in head tube</li> </ul>	<ul style="list-style-type: none"> <li>- True wheel or take to a bike shop for repair</li> <li>- Tighten bolts</li> <li>- Center brakes and/or adjust brake block Toe-in</li> <li>- Tighten headset</li> </ul>

<b>Problem</b>	<b>Possible Cause</b>	<b>Remedy</b>
Wobbling wheel	<ul style="list-style-type: none"> <li>- Axle broken</li> <li>- Wheel out of true</li> <li>- Hub comes loose</li> <li>- Headset binding</li> <li>- Hub bearings collapsed</li> <li>- QR mechanism loose</li> </ul>	<ul style="list-style-type: none"> <li>- Replace axle</li> <li>- True wheel</li> <li>- Adjust hub bearings</li> <li>- Adjust headset</li> <li>- Replace bearings</li> <li>- Adjust QR mechanism</li> </ul>
Steering not accurate	<ul style="list-style-type: none"> <li>- Wheels not aligned in frame</li> <li>- Headset loose or binding</li> <li>- Front forks or frame bent</li> </ul>	<ul style="list-style-type: none"> <li>- Align wheels correctly</li> <li>- Adjust /tighten headset</li> <li>- Take bike to a bike shop for possible frame realignment</li> </ul>
Frequent punctures	<ul style="list-style-type: none"> <li>- Inner tube old or faulty</li> <li>- Tire tread/casing worn</li> <li>- Tire unsuited to rim</li> <li>- Tire not checked after previous puncture</li> <li>- Tire pressure too low</li> <li>- Spoke protruding into rim</li> </ul>	<ul style="list-style-type: none"> <li>- Replace inner tube</li> <li>- Replace tire</li> <li>- Replace with correct tire</li> <li>- Remove sharp object embedded in tire</li> <li>- Correct tire pressure</li> <li>- File down spoke</li> </ul>
Bicycle has reduced range And/or speed	<ul style="list-style-type: none"> <li>- Low batteries</li> <li>- Faulty or old batteries</li> <li>- Low tire pressure</li> <li>- Brakes dragging against rim</li> <li>- Riding in hilly terrain, headwind, etc.</li> </ul>	<ul style="list-style-type: none"> <li>- Charge batteries for recommended time</li> <li>- Replace batteries</li> <li>- Inflate tires to recommended pressure</li> <li>- Adjust brakes and/or rim</li> <li>- Reduced range to be expected in these Types of terrain and/or weather conditions</li> </ul>
Hub motor makes a “clicking” noise and has reduce power and/or shuts off	<ul style="list-style-type: none"> <li>- Low batteries</li> <li>- Damaged planetary gears</li> </ul>	<ul style="list-style-type: none"> <li>- Charge batteries for recommended time</li> <li>- Replace hub motor/wheel</li> </ul>

<b>Problem</b>	<b>Possible Cause</b>	<b>Remedy</b>
No power when the switch is turned "ON"	<ul style="list-style-type: none"> <li>- Blown fuse</li> <li>- Loose connectors</li> <li>- Broke wire</li> <li>- Faulty switch</li> <li>- Faulty controller</li> </ul>	<ul style="list-style-type: none"> <li>- Replace fuse</li> <li>- Check all connectors</li> <li>- Inspect all wires for damage</li> <li>- Replace switch and retest</li> <li>- Replace controller and retest</li> </ul>
Bicycle operates OK but battery gauge does not light up	<ul style="list-style-type: none"> <li>- Loose connectors</li> <li>- Damaged wires</li> <li>- Faulty battery gauge</li> </ul>	<ul style="list-style-type: none"> <li>- Check throttle and/or battery gauge connectors</li> <li>- Inspect all wires</li> <li>- Replace battery gauge</li> </ul>
Battery gauge lights up but bicycle does not operate	<ul style="list-style-type: none"> <li>- Faulty brake inhibitor</li> <li>- Loose motor wire connector</li> </ul>	<ul style="list-style-type: none"> <li>- Replace brake inhibitor(s) and retest</li> <li>- Check motor wire connector</li> </ul>
Bicycle runs at full speed without pedaling	<ul style="list-style-type: none"> <li>- Faulty sensor</li> <li>- Faulty throttle</li> <li>- Faulty controller</li> </ul>	<ul style="list-style-type: none"> <li>- Replace sensor and retest</li> <li>- Replace throttle and retest</li> <li>- Replace controller and retest</li> </ul>
Battery indicates full charge when tested at the charge port but bicycle does not operate	<ul style="list-style-type: none"> <li>- Faulty controller</li> <li>- Loose connectors</li> <li>- Poor contact between battery terminals</li> </ul>	<ul style="list-style-type: none"> <li>- Replace controller</li> <li>- Check all connectors</li> <li>- Inspect and clean battery terminals</li> </ul>
Throttle(on bicycle so equipped) does Not spring back to neutral position	<ul style="list-style-type: none"> <li>- Grip jammed against throttle</li> <li>- Faulty throttle</li> </ul>	<ul style="list-style-type: none"> <li>- Reposition grip so gap between it and the Throttle is 1-2mm</li> <li>- Replace throttle</li> </ul>



<b>Problem</b>	<b>Possible Cause</b>	<b>Remedy</b>
Bicycle has intermittent power	<ul style="list-style-type: none"> <li>- Loose connectors</li> <li>- Damaged wires</li> </ul>	<ul style="list-style-type: none"> <li>- Check all connectors</li> <li>- Inspect all wires</li> </ul>
Charge shows a full charge in an Unusually short amount of time	<ul style="list-style-type: none"> <li>- Faulty charger</li> <li>- Faulty batteries</li> </ul>	<ul style="list-style-type: none"> <li>- Replace charger</li> <li>- Replace batteries</li> </ul>
Indicator light on charger not Illuminated when charger is Plugged into outlet	<ul style="list-style-type: none"> <li>- Outlet has no power</li> <li>- Faulty charger</li> </ul>	<ul style="list-style-type: none"> <li>- Check outlet for power</li> <li>- Replace charger</li> </ul>
Charger(Lithium) indicator light only flashes red and never changes to green	<ul style="list-style-type: none"> <li>- Damage wire from charger port to battery</li> <li>- Faulty batteries</li> </ul>	<ul style="list-style-type: none"> <li>- Inspect wire</li> <li>- Replace batteries</li> </ul>



**Use approved replacement parts, particularly for safety critical components.  
Consult with your dealer as needed.**

## **ABOUT SEALER AND INFORMATION CARD**

### **Purchase record card**

Fill in immediately and retain as a record of your purchase

*\* Please retain your sales receipt for any possible warranty claims*

**Your name:** \_\_\_\_\_

**Address:** \_\_\_\_\_

**Date purchased :** \_\_\_\_\_ **Place of purchase:** \_\_\_\_\_

**Model & brand information:** \_\_\_\_\_

**Wheel size:** \_\_\_\_\_

**Color:** \_\_\_\_\_

**Serial number:** \_\_\_\_\_