

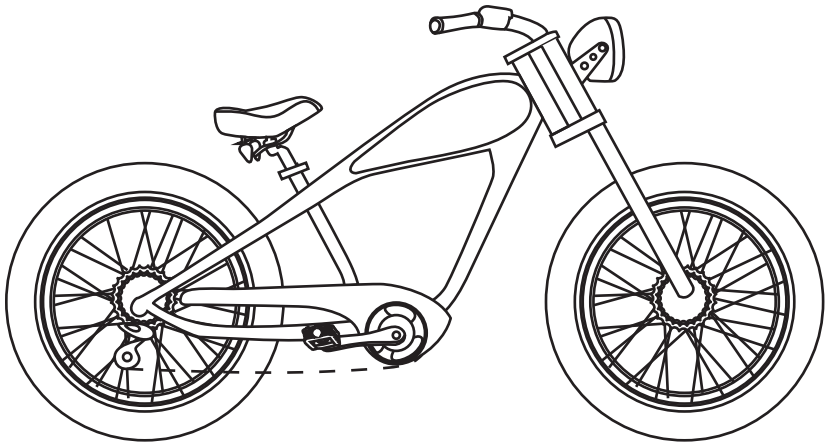

CIVI BIKES™



CHEETAH

USER'S MANUAL

Thanks for purchasing a CIVIBIKES™ Cheetah electric bike. CIVIBIKES™ are one of the best electric bike companies based in Ontario, CA. We produce high-quality and unique style electric bike with high-profile components.

After receiving your new bike, firstly please check exterior of package. If you found severe damage on the surface or at the corner, please contact CIVIBIKES™ by email to info@civibikes.com or call (909)215-4815 to check whether you need a return and refund. Get more information about warrenty and return policy on Page **XXX**.

Open the carton box and take out your Cheetah carefully. The package has following items:

CHEETAH	CHARGER	PEDALS	FRONT WHEEL AXLE	Head light
---------	---------	--------	------------------------	---------------

Remove all zip ties and packing material. Attention: be careful when it comes to the edge of frame, tire and rim..

Follow steps to assembly your Cheetah!

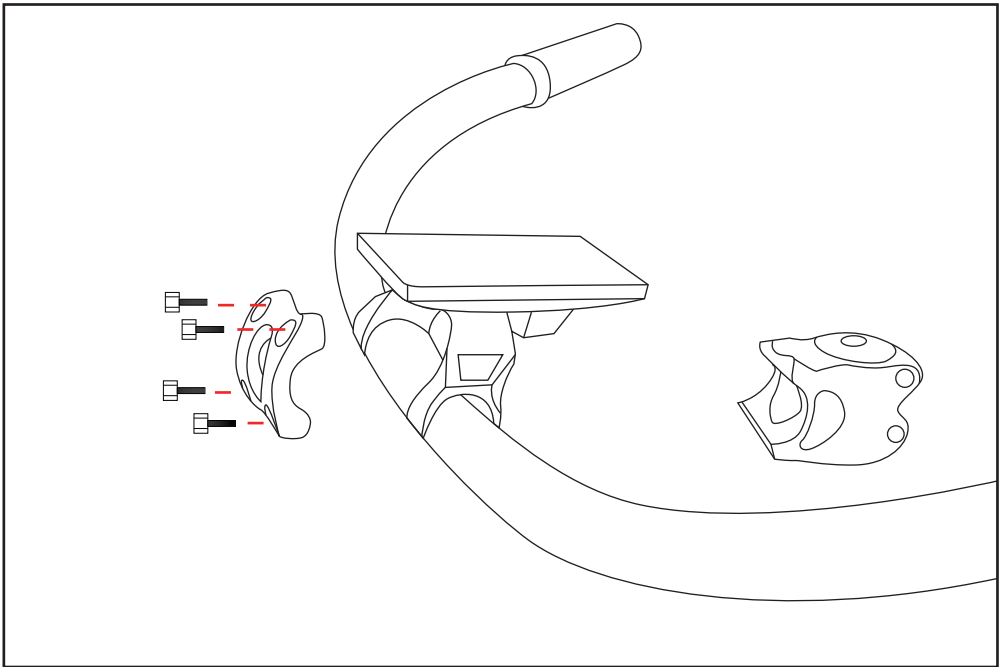

Install Handle Bar

Loosen the bolts to put handle bar in between.

Use the reserved 4 bolts to install handle bar as picture shown.

Adjust handle bar angle and fasten the 4 bolts one by one to 20N.M.

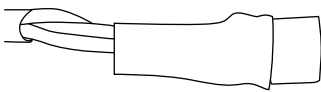
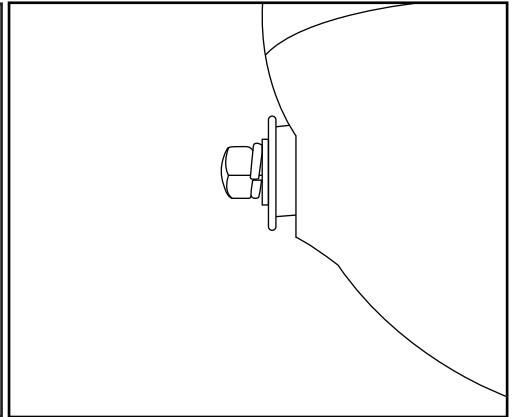
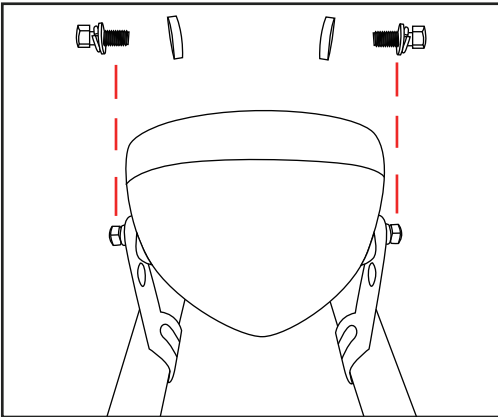
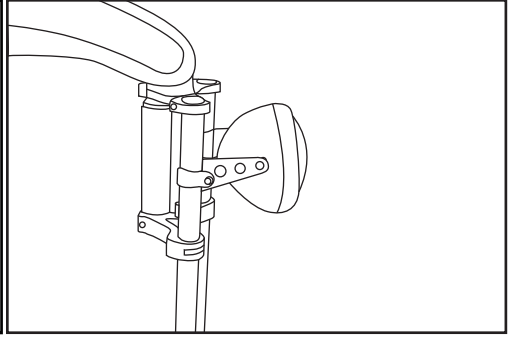
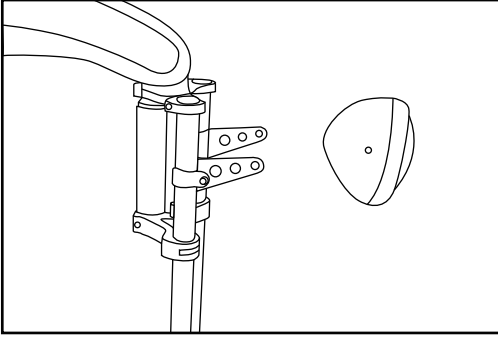

headlight

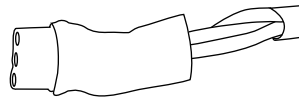

frame

Install Head Light

Use reserved bolts and bushing to install head light. Adjust height and angle, then fasten all the bolts.

Connect the light power cable.

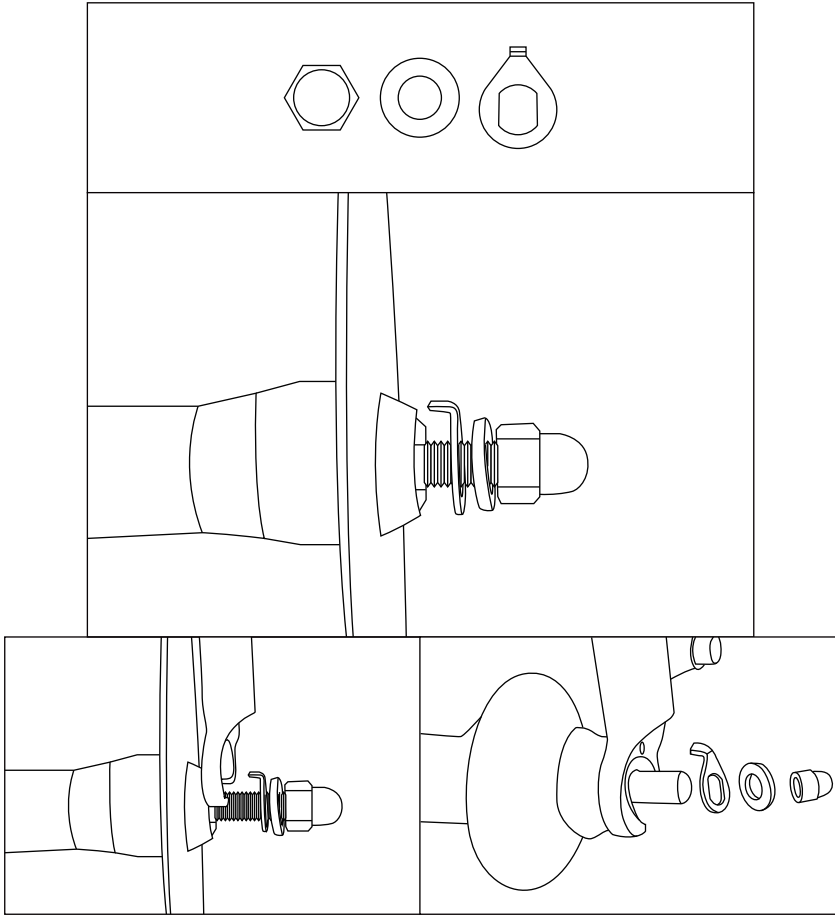

Install Front Wheel

Make sure the brake disc is placed in the center of caliper gap and front wheel can rotate freely without any noise.

When the brake disc is not in the gap, DO NOT pull brake lever.

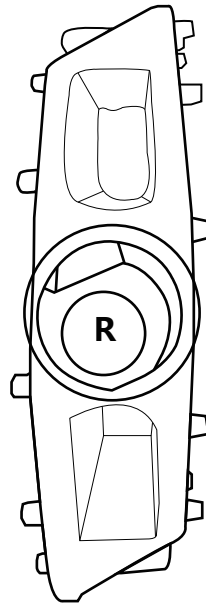
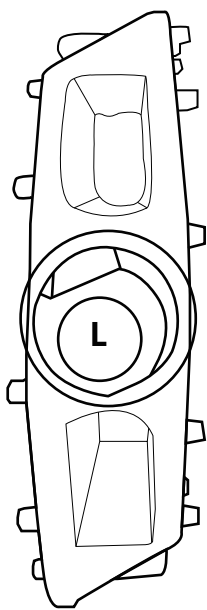

Install Pedals

Use the pedal marked with an "L" on the left side and the right pedal marked with an "R" on the right side (side with drivetrain gears). The right-side pedal has a right-hand thread (removes counterclockwise, installs clockwise); the left side pedal has a left-hand thread (removes clockwise, installs counterclockwise). Be careful to not cross thread the pedals.

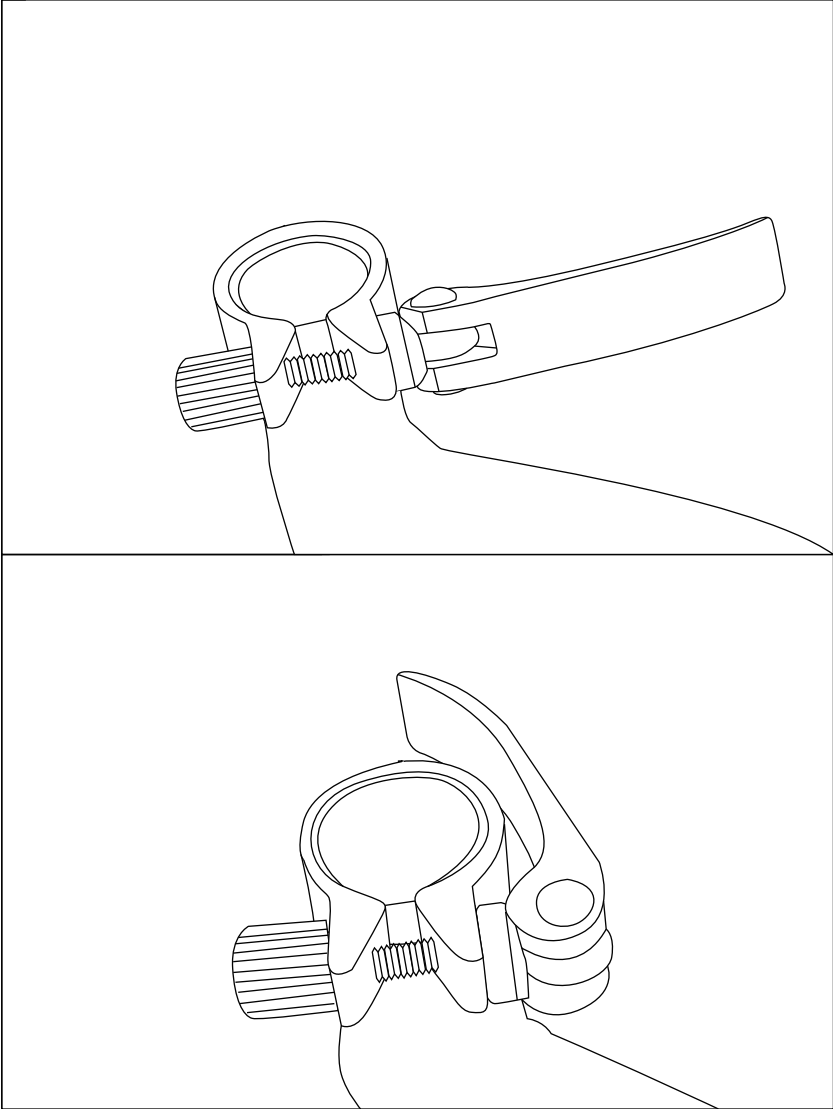

Insert, Remove or Adjust Saddle Height

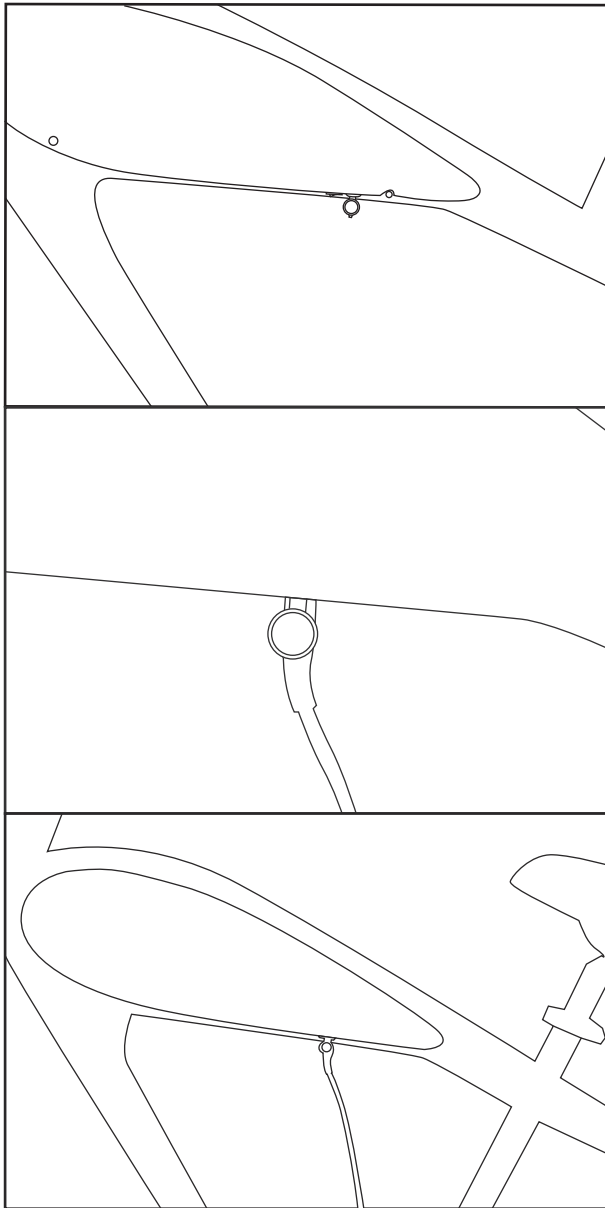

Charge Battery before Your First Ride

*On charger adapter, red light stands for charging, while green light stands for charging finished.

Some Battery Tips

- Lithium battery capacity drops down by times they've been used for. CIVIBIKES™ genuine battery provides 600~800 charging cycles.
- Stay away from extreme environment. Most suitable temperature for battery is 14 °F ~113°F . Do not approach heat, fire, inflammable and prevent battery from falling and getting wet. Do not insert metal into battery.
- Battery indicator bar on LCD display sometimes is biased. If you want to get more accurate indication, try to run totally out of battery then charge it charged to full. BMS will reset the indicator randomly.
- Frequent accelerating and brake drain your battery much more quickly than you expected. When you don't have enough battery, twist throttle gently to be safe back.
- 8 hours not using the battery still consumes around 5% battery capacity to standby and support BMS.
- If you are not going to use the battery for long time, take out the battery out of your CIVI™ BIKE, and store it with 50% battery left. Do not use battery when it has less than 10% capacity left.
- Our bike is water proof but only splash proof. Please do not put the bike in water deeper than 7.0 inch, otherwise controller box has risk of mould.
- If you keep charging your battery more than 12 hrs but not full yet, stop charging and contact with CIVIBIKES™ as soon as possible.

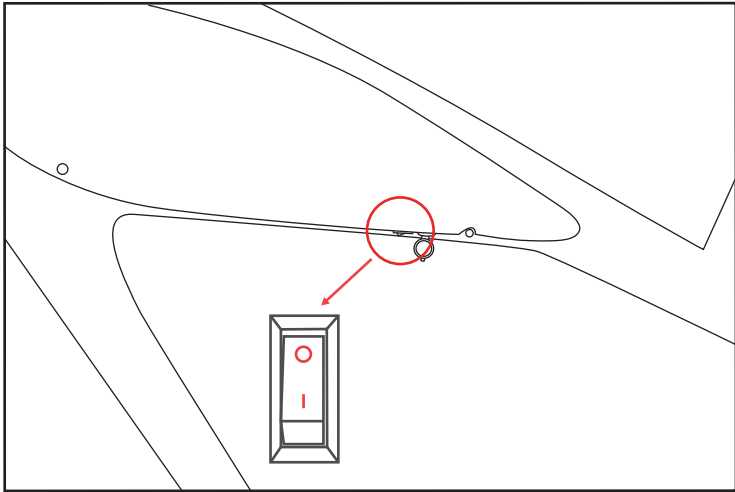

Power ON/OFF your battery

Beside the charging port, you'll find a separate switch to power ON/OFF your battery.

Make sure switch on before your ride, and off after ride.

It helps protect the battery from draining itself.

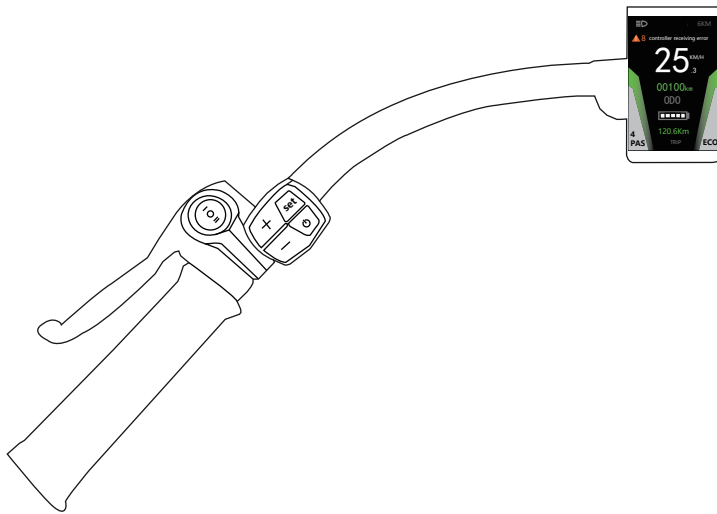

Head Light Control

On the handle bar, there is a separate switch for head light. Push the button down to:

- Downside: Low Beam
- Upside: High Beam

Don't forget to switch off the light and battery when you finish riding. This operation helps a lot with your battery lifetime.

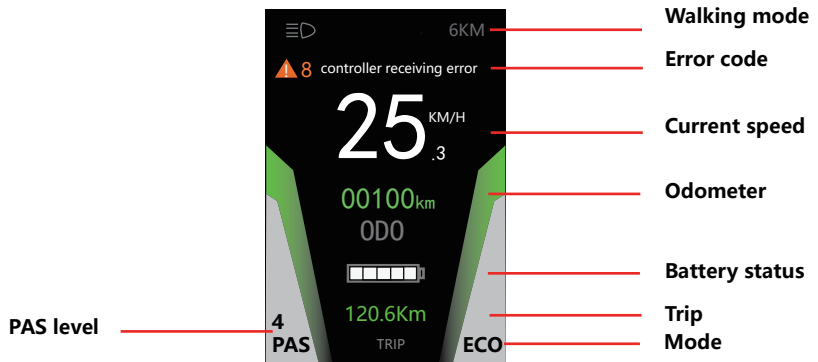

LCD Brief Manual

- To switch on the eBike system, Press power button on handle bar. Same way to shut off.
- After switching on the eBike system, you can press Set button to switch between ECO, STANDARD, and POWER modes
- Press + or - to adjust PAS speed level. There are 5 PAS levels by default.
- Hold Set button for 2 seconds to enter setting interface, where you have bunch of options to customize.
- For more advanced settings, visit www.civibikes.com/pages/setup

Troubleshooting

If there are errors about the electronic control system, the error code will appear automatically.

Error Code	Definition	Solution
1	Current error or MOS damaged	Replace controller
2	Throttle Abnormality	Disconnect throttle wire (located in controller box, or in front of handle bar if the bike has water proof quick release connector) to see whether the ERROR code disappears. If disappear, replace throttle.
3	Motor Abnormality	Re-connect motor wire (located underneath chain stay at right side). If still doesn't work, replace a new motor.
4	Motor Hall Abnormality	Contact with seller, return full rear wheel to replace a motor rotor.

5	Brake Abnormality	Disconnect 2 brake lever wires(located in front of handle bar to see whether the ERROR code disappears. If yes, replace the brake lever and reconnect brake lever wire to controller.
6	Under voltage	Fully charge the battery
7	Motor stalling	Do not block motor from rotating freely
8	communication controller receiving error	Disconnect all wires (brake lever, display, throttle, and motor) then reconnect. Check all connectors are in good connection.
9	communication display receiving error	

CIVIBIKES™ LIMITED WARRANTY

To make a warranty claim always keep handy the vehicle model, date of purchase, vehicle serial number as well as information from the retailer where you purchase the vehicle from.

The warranty is limited to the terms listed below:

Motor and controller: 1 year for parts. 3 months for labor

Frame: 3 years, 1 year for labor

Charger: 1 year for parts

Battery: Warranty on the battery starts the date of purchase of the vehicle as new. The battery is sealed and cannot be opened or fixed. The battery should not have a percentage of nominal charge retention of 60% or less. Misuse of the battery, negligence or attempt to open or repair it will void the warranty.

General vehicle: The vehicle is backed up by a 1-year main warranty, certain components listed on this chart or consumables may be subject to a different period of coverage or not included in this warranty.

Consumables: Components subject to wear are not covered by the warranty: Tires, inner tubes, brake lines, brake pads, basket, wheel lining tape, light bulbs, LEDS, fuses, etc.

If the warranty is void for any reason the customer shall bear any repair or replacement costs resulting from vehicle misuse, negligence or abuse.

Always follow care and preventive maintenance procedures

Always keep receipts from any services performed to the vehicle by an authorized distributor or service center.

The warranty will be voided by any of the following circumstances:

- (1) Failure to follow all directions or recommendations listed in this warranty and user's manual.
- (2) Cycling collision, accident or vehicle damage caused by careless parking or storage.
- (3) Acts in violation of laws and regulations.
- (4) Never performed service or maintenance on components
- (5) DIY repairs on electronic components.
- (6) Abusive use the vehicle in off-road terrain, mud, snow, water, sand, gravel and water puddles.
- (7) If vehicle is used as rental unit or taxi
- (8) Damages caused by natural disasters such as earthquakes, lightning, fire, flooding and other hazards .
- (9) Rust and/or paint fading caused to heavy exposure to rain, hail, snow or sunlight.
- (10) Overloading beyond recommended capacity .
- (11) Damages caused by nails, needles, broken glass , debris , sharp rocks or other foreign objects .
- (12) If vehicle is used but not limited to stunts, jumping from ramps, stairs or elevated surfaces.
- (13) If vehicle is used in competitions or racing
- (14) If vehicle has been modified for any purposes on the motor, electrical system, suspension frame, wheels.
- (15) Use of other components not approved by the manufacturer
- (16) Damages resulted from improper transportation

Due to the nature of the product some components must be exclusive from the manufacturer such as but not limited to the battery, motor, main gauge cluster,

controllers, Led headlights, brake drums or disc rotors and pads etc. Other components such as tires, tubes, saddle, racks, baskets may be used from market-ready or compatible products previous approval from the retailer or manufacturer.



4055 E. GUAISTI RD., STE 111, ONTARIO, CA 91761
info@civibikes.com
+1 (909)215-4815

Get more information of promotion, coupon and new product launch at:
www.civibikes.com