

MDS200

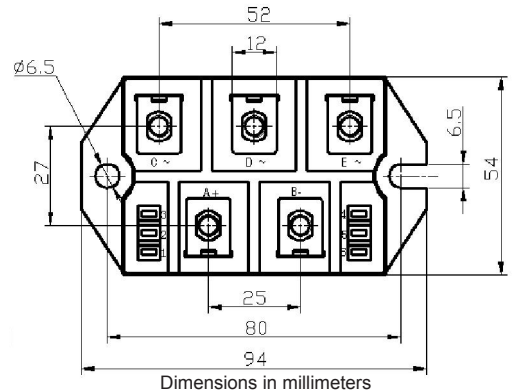

Glass Passivated ThreePhase Rectifier Bridge

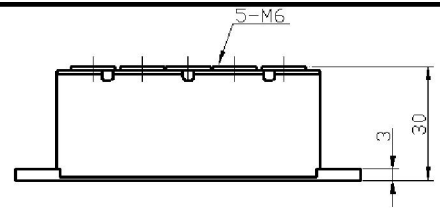
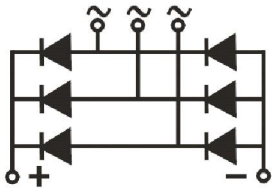

Applications

- Three phase rectifiers for power supplies
- Rectifiers for DC motor field supplies
- Battery charger rectifiers
- Input rectifiers for variable frequency drives

Features

- Three phase bridge rectifier
- Blocking voltage:800 to 1800V
- Heat transfer through aluminum oxide DBC ceramic isolated metal baseplate
- Glass passivated chip
- UL recognized applied for file no. E360040

Module Type

TYPE	VRRM	VRSM
MDS200-08	800V	900V
MDS200-12	1200V	1300V
MDS200-16	1600V	1700V
MDS200-18	1800V	1900V

Maximum Ratings

Symbol	Conditions	Values	Units
ID	Three phase, full wave Tc=100°C	200	A
IFSM	t=10mS Tvj =45°C	2240	A
i ² t	t=10mS Tvj =45°C	25000	A ² s
Visol	a.c.50HZ;r.m.s.;1min	3000	V
Tvj		-40 to +150	°C
Tstg		-40 to +125	°C
Mt	To terminals(M6)	5±15%	Nm
Ms	To heatsink(M6)	5±15%	Nm
Weight	Module (Approximately)	194	g

Thermal Characteristics

Symbol	Conditions	Values	Units
Rth(j-c)	Per diode	0.45	°C/W
Rth(c-s)	Module (Approximately)	0.025	°C/W

Electrical Characteristics

Symbol	Conditions	Values			Units
		Min.	Typ.	Max.	
V _{FM}	T=25°C I _F =300A	—	1.45	1.70	V
I _{RD}	T _{vj} =25°C V _{RD} =V _{RRM}	—	—	0.5	mA
	T _{vj} =150°C V _{RD} =V _{RRM}	—	—	6	mA

MDS200

Performance Curves

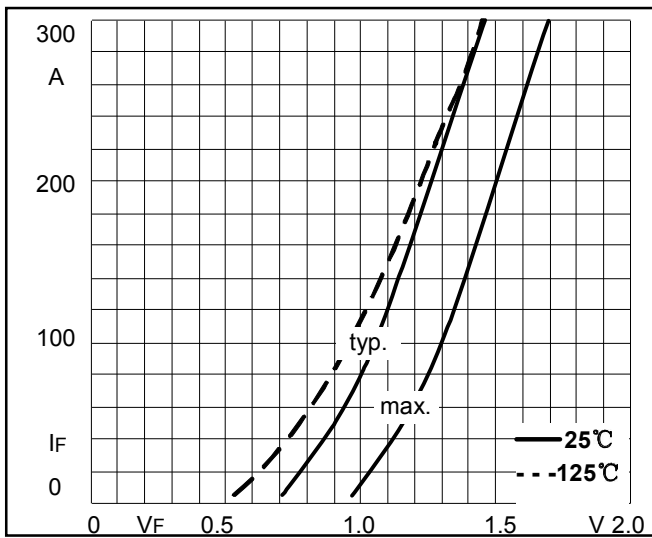

Fig1. Forward Characteristics

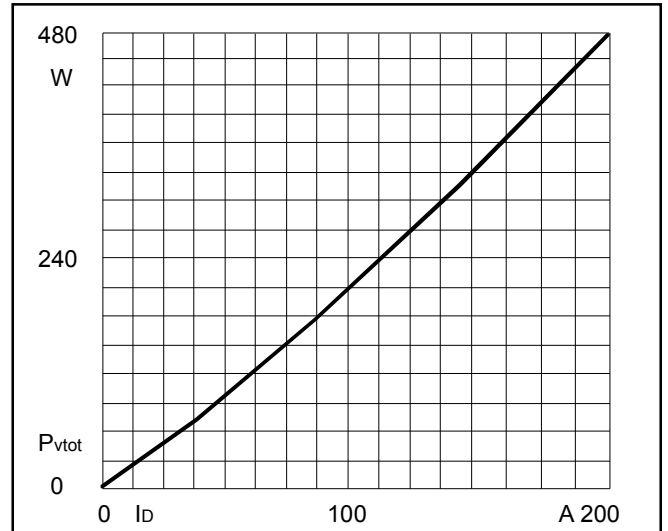

Fig2. Power dissipation

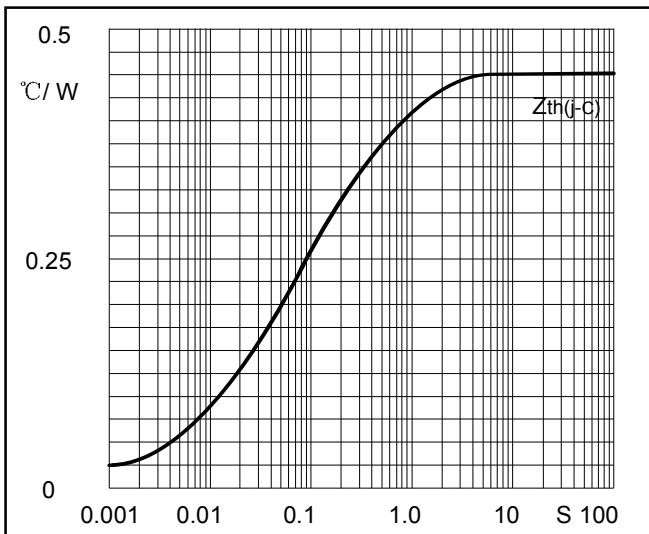

Fig3. Transient thermal impedance

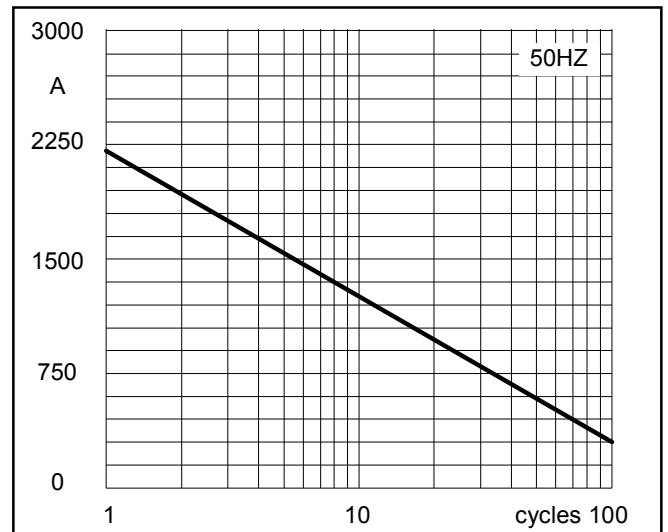

Fig4. Max Non-Repetitive Forward Surge Current

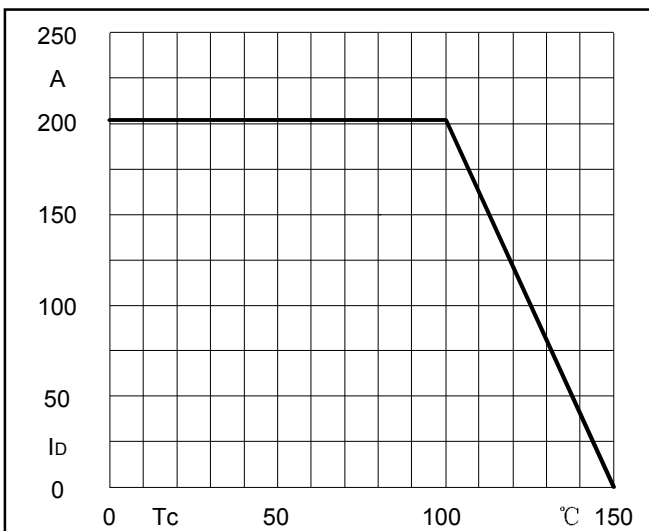

Fig5. Forward Current Derating Curve